

Pro Audio & Broadcast Catalog
Sixth Edition

Switchcraft®

Switchcraft®
www.switchcraft.com



Patchbays, Patchcords &
Molded Cable Assemblies



Connectors and Adapters



Jacks and Plugs



Guitar Switches

About Switchcraft, Inc.

Switchcraft, Inc. was established in 1946 to manufacture jacks, plugs, and switches. We have since become the industry leader in producing a wide variety of connectors, adapters, jacks and plugs, patchbays, jackfields, and switches. While our products cover a diverse number of markets, this catalog focuses on our line of audio and video products, typically found in broadcast, recording, sound reinforcement, and other pro audio applications.

Some of the new products you'll find in this catalog include our EZ Norm Series of audio patchbays, where normal configurations can be changed from the front of the patchbay, using a standard screwdriver. Also found in this edition are new combination audio/video patchbays in both standard/long-frame and midsize/bantam styles. In the connector section, we're offering a new line of connectors called our EH Series, incorporating a wide range of connectors (Firewire, USB, Category 6, BNC, RCA, and more) in a standard XLR housing.

Please keep in mind that this is just a small sampling of our complete product lines. For more detailed information, we offer our "full line" catalog, our Engineering Design Guide.

Our Engineering Design Guide includes over 5,000 part numbers covering all five major product lines. If you don't see it here, chances are you'll find it in the EDG. And again, keep in mind that the EDG is also just a "snapshot" of our capabilities. We manufacture over 30,000 part numbers, so if it's not in the EDG, please contact us with your requirements. To keep up on all the new products we have to offer, visit our website at www.switchcraft.com and look for the New Product Showcase.

Patchbay Series 4 – 43

Patchcords/Molded Cables 44 – 45

Connector Series 46 – 62

Audio Adapter Series 63 – 64

Jack Series 65 – 82

Plug Series 83 – 93

Switch Series 94 – 96

Index 98 – 100

2 Table of Contents

Patchbays

Professional Punchdown Terminal (PPT)	4
Audio Patchbay Series	5-33
MTPH/TTPH Harness Series	5-7
Front Access Series	8-9
EZ Norm Patchbay Series	10-11
RS 422 Data Patchbay Series	12-13
MTP48K Wired Series	14-15
TTPW96K Wired Series	16-17
MTPBP/TTPBP Backpanel Series	18-19
TT96 EDAC Series	20-21
TTP96K Patchkit Series	22-23
MT48K/MT52K Patchkit Series	24-25
MT48/MT52 Patchbay Series	26-27
TTP96AS Patchbay Series.....	28-29
HPC Patchbay Series	30-31
Q-G® Patchbay Series	32-33
Video/Audio Patchbay Series.....	34-44
VPP Video Patchbay Series.....	34-36
MVP Midsize Video Patchbay Series	37-39
VAP Video/Audio Patchbay Series	40-41
MVEZN Audio/Midsize Patchbay Series.....	42
MBPK Video/Audio Patchbay Series	43
Audio and Video Patchcords	44-45

Connectors

Q-G® Audio Connector Series	46-48
A, AA, AAA Cord Style Series	46
B, C, D, E Panel Style Series.....	47
J, K, P, R, T Wallplate, Gooseneck, Panel & Cord Style Series.....	48
Tini-Q-G® Connector Series	49
Tini-Q-G® Cord & Panel Style Series	49
HPC Connector Series	50-51
HPC Panel Style Series	50
HPC Cord, & Adapter Style Series.....	51
EH Series Receptacles	52
MIDI and 2500 Series	53
HP75BNC Series	54
Connector Dimension Drawings	55-62
HP75BNC Series, EH Series	55
Q-G Audio - A, AA, AAA Series	56
Q-G Audio - B, C, D, E Series	57
Q-G Audio - J, K, P, R Series.....	58
Q-G Audio - T Series	59
MIDI, Q-G Audio - P Series	60
HPC Panel Style Series	61-62

Audio Adapters

XLR to XLR, RCA, 1/4", TQ-G Adapter Series	63
1/4" to 1/4", RCA; RCA to RCA; & Miscellaneous Adapter Series	64

Jacks & Plugs

Jack Series

Littel Phone, Hi-D, Right Angle PC Mount 1/4", 1/4" Extension Jack Series65

Thick Panel/Guitar, Locking 1/4", Tini, Tini-Extension, Micro, 3.5mm67

Phono, Phono Extension, TT or Bantam, MT 1/4" Jack Series69

Power/Jacks Plugs Series – 700, S700, 800 Cord & Panel Style Series71

Jack Series Dimension Drawings72–82

Littel Phone, Hi-D, 1/4" Extension, 700 Panel Jack Series72

Littel Phone, Hi-D, 1/4" Extension Jack Series73

Right Angle PC Mount 1/4" Jack Series74

Thick Panel/Guitar, Locking 1/4", Tini, Tini Extension Jack Series75

Micro, 3.5mm Jack Series76

3.5mm Jack Series.....77–79

Phono and Phono Extension Jack Series80

TT or Bantam Jack Series.....81

MT 1/4" Jack Series.....82

Plug Series

Littel 1/4", Right Angle 1/4", Silent, Super Heavy Duty Plug Series83

Tini, Micro, 3.5mm Stereo, Right Angle 3.5mm Stereo, Phono, Right Angle Phono Plugs Series ..85

TT or Bantam, Mil-Style 1/4" Plugs Series87

Plug Series Dimension Drawings88–93

Littel Plug 1/4" Series88

Littel Right Angle 1/4", Silent, Super Heavy Duty Plug Series89

Tini, Micro Plug Series90

35HD 3.5mm Stereo Plug Series91

Phono and Phone Right Angle Plug Series92

TT or Bantam, Mil-Style 1/4" Plug Series93

Switches

Switch Series94–95

Switch Series Dimension Drawings96

Limited Lifetime Warranty

Switchcraft warrants all of its products to be of sound design, good materials and workmanship at the time of manufacture.

Switchcraft will repair or replace at its discretion any product proven to be defective under normal use.

Switchcraft's liability under the terms of this warranty is limited to the repair or replacement of defective products which have not been damaged through accident, abuse, misuse or unauthorized repair. Switchcraft shall in no case be liable for special or consequential damages of any nature.



PATCHBAYS

4 Our Patchbays Now Feature the New Professional Punchdown Terminal (PPT)

Our Patchbays Have Just Rounded A New Corner

Actually, the corners we rounded belong to our patchbays' revolutionary, new Professional Terminal (PPT), making it perfectly compatible with the industry standard. We realized that achieving a new industry standard meant we couldn't cut any corners to get there.

The PPT design incorporates a split-barrel design and a more rugged, thicker housing to minimize the impact of repeated punchdowns. The split-barrel design eliminates the problems associated with the old "V-shaped" terminal designs. The PPT design distributes pressure evenly across both sides of the terminated wire, causing improved wire retention plus more reliable connections. The serrated teeth in the plastic housing firmly grip the wires, which also greatly improves wire retention. With the PPT, multiple wires can be terminated to a single contact, and a wide range of wire gauges can be used.

Look for Switchcraft's PPT in our MTP and TTP Series of audio patchbays, and in our new Backpanel Series. All Switchcraft audio patchbays incorporate heavy gauge materials and our high quality nickel-plated, steel framed jacks. Gold-plated, crossbar contacts come standard!



Materials

- Housing: Thermoplastic (UL 94V-0)
- Contacts: High strength copper alloy, tin plated
- Wire size: Accommodates #22, 24, or 26 AWG, stranded or solid

Accessories

Part Number	Description
K459	PPT replacement kit consists of 15 of each color* (IDC/IDC)
K460	PPT replacement kit consists of 15 of each color (IDC/wirewrap)
PT1LA	PPT impact punchdown tool
PT2B	Replacement bit for PT1LA tool

**Colors consist of red, black, white, yellow, blue, and orange.*

Switchcraft

MTPH/TPH Harness Series

Features and Benefits

- Units feature either 48 MT style jacks or 96 TT style jacks on the front panels, to a 4 foot harness, out to a backpanel with PPT's
- All versions utilize AES/EBU wiring for complete digital compatibility
- Attractive, corrosion resistant nickel-plated, steel frame jacks
- Gold-plated switching contacts reduce contact resistance, improve reliability

Specifications

Materials

Jacks

- Frame: Nickel-plated steel
- Bushing: Nickel-plated brass
- Tip, Ring and Shunt Springs: Nickel silver with welded contacts
- Assembly Screws: Zinc-plated steel
- Welded Contacts: Gold alloy

Panel

- Front Channel: Black anodized aluminum
- Frame: C.R.S. black epoxy painted
- Designation Strips: Black polycarbonate 94V-0
- Designation Strip Covers: Clear polycarbonate
- Jack Inserts: Thermoplastic polyester

Mechanical

- Life: 30,000 cycles
- Insertion Force: 7 lbs. maximum
- Withdrawal Force: 1 lb. minimum
- Environmental: 0°C to +50°C

Electrical

- Contact Resistance: 30 milliohms maximum initial
- Insulation Resistance: 10,000 megohms maximum
- Dielectric Withstanding Voltage: 500 VAC at 60 Hz
- Working Voltage: 140 VDC maximum
- Current Rating: 100 milliamps



The MTPH and TPH Harness Series utilize standard front panel assemblies, a 4-foot cable harness, and our standard back panel assemblies. Primarily used where the back panels must either be mounted into a rack, or brought back to the front for easier access. Custom cable lengths can also be supplied. Contact the factory for details.

Ordering Information

Part Number	Type of Jack	No. of Jacks	Description
MTPH48K1NS	MT	48	1.75" High front panel, 4' Harness, 3.5" High back panel, normals strapped
MTPH48K1NO	MT	48	1.75" High front panel, 4' Harness, 3.5" High back panel, normals brought out
MTPH48K3NS	MT	48	3.5" High front panel, 4' Harness, 3.5" High back panel, normals strapped
MTPH48K3NO	MT	48	3.5" High front panel, 4' Harness, 3.5" High back panel, normals brought out
MTPH48K3SNO	MT	48	3.5" High front panel, 4' Harness, 3.5" High back panel, sleeve normals brought out
TPH96K1NS	TT	96	1.75" High front panel, 4' Harness, 3.5" High back panel, normals strapped
TPH96K1NO	TT	96	1.75" High front panel, 4' Harness, 5.25" High back panel, normals brought out
TPH96K3NS	TT	96	3.5" High front panel, 4' Harness, 3.5" High back panel, normals strapped
TPH96K3NO	TT	96	3.5" High front panel, 4' Harness, 5.25" High back panel, normals brought out

See Next Page for Mechanical Drawings

PATCHBAYS

6 MTPH/TPPH Harness Series



MTPH/TPPH Harness Series

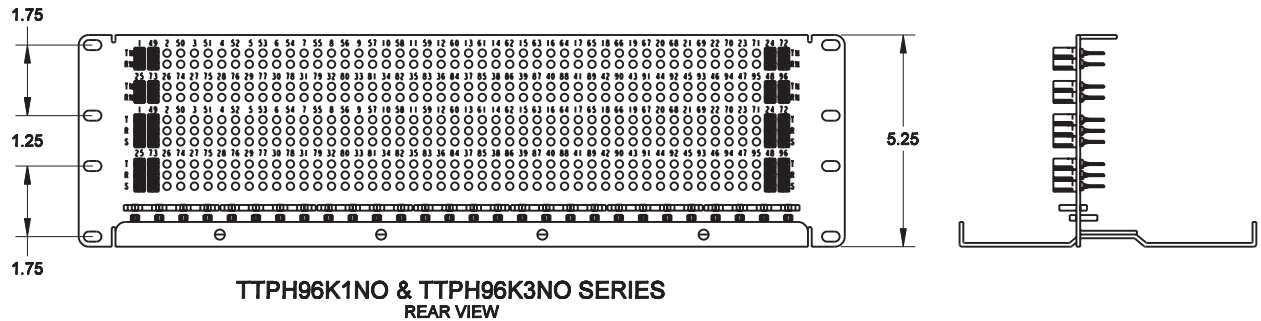
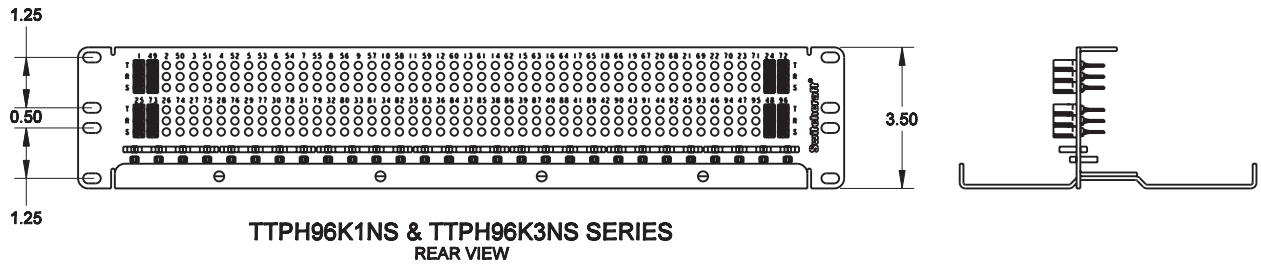
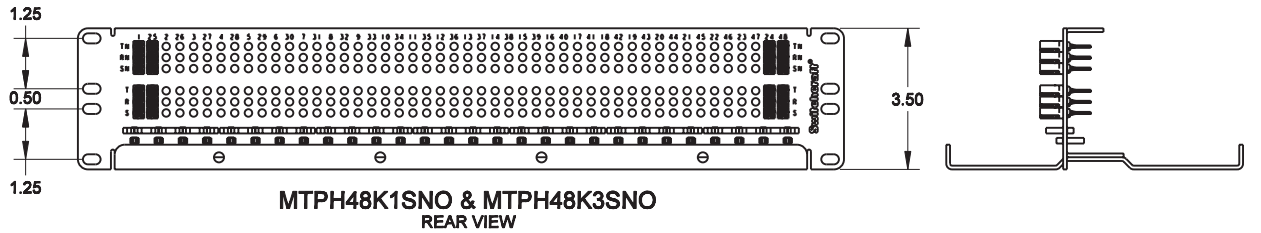

DIMENSIONS ARE FOR REFERENCE ONLY

Inch
(mm)

PATCHBAYS

8 Front Access Series

Features and Benefits

- Easy slide-out tray slides forward for easy re-termination from the front of the rack
- Available with either 48 MT style or 96 TT style jacks in a 1RU space
- Attractive, corrosion resistant nickel-plated, steel frame jacks
- Gold-plated switching contacts reduce contact resistance, improves reliability
- Extra wide designation strips for easy channel identification
- Rugged, attractive black epoxy-finished steel chassis
- Configurations available include normals strapped and normals brought out

Specifications

Materials

Jacks

- Frame: Nickel-plated steel
- Bushing: Nickel-plated brass
- Tip, Ring and Shunt Springs: Nickel silver with welded contacts
- Assembly Screws: Nickel-plated steel
- Welded Contacts: Gold alloy

Panel

- Frame: C.R.S. black epoxy painted
- Designation Strips: Black polycarbonate 94V-0
- Designation Strip Covers: Clear polycarbonate
- Jack Inserts: Thermoplastic 94V-0

Mechanical

- Life: 30,000 cycles
- Insertion Force: 7 lbs. maximum
- Withdrawal Force: 1 lb. minimum
- Operating: -20°C to +65°C



The Front Access Series offers the end user the ease of re-terminating patchpoints from the front of the rack as opposed to the back. A slide out tray allows the user to slide out the punchdown terminals and reconfigure the unit. An easy release mechanism on either side of the unit allows it to be pushed back into place and easy to grip locking nuts tighten the unit in place.

Electrical

- Jack Contact Resistance: 30 milliohms initial maximum; 50 milliohms after life
- Jack Insulation Resistance: 10,000 megohms maximum
- Dielectric Withstanding Voltage: 500V at 60 Hz AC
- Working Voltage: 100 milliamps or less; maximum 56.5 VDC

Ordering Information

Part Number	Type of Jack	No. of Jacks	Description
TTPFA96K1NS	TT	96	1.75" High, normals strapped
TTPFA96K1NO	TT	96	1.75" High, normals brought out
MTPFA48K1NS	MT	48	1.75" High, normals strapped
MTPFA48K1NO	MT	48	1.75" High, normals brought out

Switel

PATCHBAYS

Front Access Series



DIMENSIONS ARE FOR REFERENCE ONLY

Inch
(mm)

Switchcraft
 www.switchcraft.com

5555 North Elston Avenue / Chicago, IL 60630
 Phone: 773-792-2700 / Fax: 773-792-2129

PATCHBAYS

10 EZ Norm Patchbay Series



Center Strip Removes For Normalling Access



Easily Normal The Jacks By Rotating To "Full", "Non," Or "Half" Positions

The EZ Norm offers a simplified method for setting up and changing normals to a Bantam/TT patchbay. Simply remove the middle designation strip, and rotate the center cam, using a standard screwdriver. An audible "click" can be heard as you rotate from full normals to no normals to half normals. An opaque marking strip is included to conceal the normal position, if needed.

Specifications

Materials

Jacks

Housing & Cover: 94V-0 rated thermoplastic
Sleeve Collar: Nickel plated copper alloy
Tip, Ring, Shunt, & Sleeve Springs: Nickel Silver with welded contacts
Welded Contacts: Gold
Cam Switching Springs: Silver plated copper alloy
Cam Switching Contacts: Silver plated copper alloy

Mechanical

Jack Mechanical Life: 30,000 cycles
Cam Contact Mechanical Life: 30,000 cycles
Insertion - Withdrawal Forces: 1 - 4 lbs.
Moisture resistance: MIL-STD 202 Method 106
Thermal shock: MIL-STD 202 Method 107
Salt spray: MIL-STD Method 101 (48 hrs.)
Vibration: MIL-STD 202 Method 213

Electrical

Jack Spring Contact Resistance: 30 milliohm Maximum
Cam Switch Contact Resistance: 30 milliohm Maximum
Insulation Resistance: 10,000 Megaohms
Dielectric Withstanding Voltage: 500 VAC (rms) at 60 Hz
Insertion Loss: -0.5dB up to 10 MHz

EZ Norm Patchbay Options

- 1RU can be terminated to EDAC or Cannon DL, solder terminals, or wire-wrap terminals
- 1.5RU can be terminated to EDAC/Cannon DL, solder terminals, wire-wrap terminals, plus 3 pin connectors, or our own PPT Professional Punchdown Terminal
- 2RU Same as above
- All units will be offered with or w/o docking connector
- Unwired units will be offered with either cable tie bar or cable tray

Switel

EZ Norm Patchbay Series 11

Racks

The EZ Norm comes in 3 different rack heights, 1RU, 1.5RU, and 2 RU.

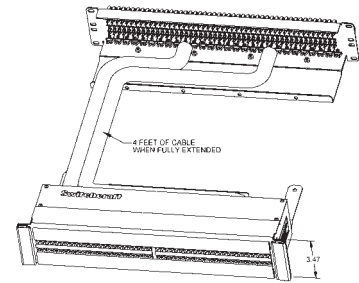
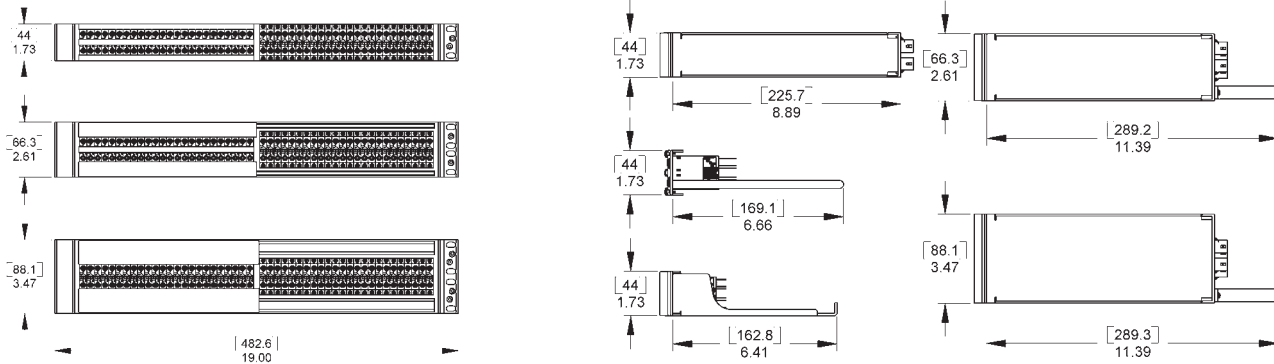

Harness Assembly

The EZ Norm is also offered as a harness assembly, with a standard harness of 4 ft. Custom lengths are available, call Switchcraft® for details.

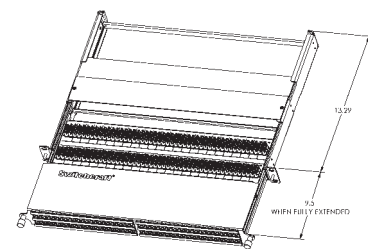
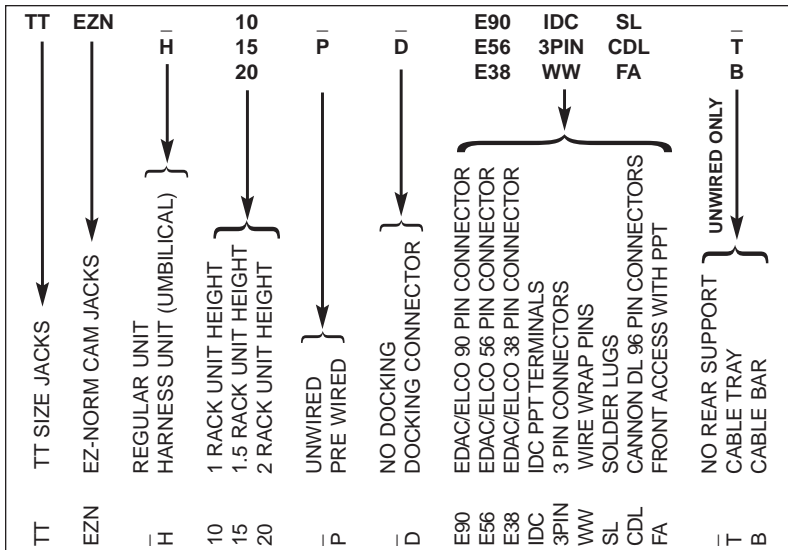

Front Access

The Front Access option offers a slide-out tray, allowing the end user to re-terminate the patchbay from the front of the rack.

DIMENSIONS ARE FOR REFERENCE ONLY

Inch
(mm)

PATCHBAYS

12 RS 422 Data Patchbay Series



Our standard RS data jackfield series offer a multiple combination of ports, rack heights, and back panel terminations which will easily fit into any television broadcast or video production where custom data patching is required. Custom ports and rack height combinations can be supplied. Contact the factory for details.

Ordering Information

Part Number*	No. of Jacks	Front Panel Layout	Back Plane	Rack Height
RS422H4N081	2 x 8	Horizontal	9 Pin D-Sub	1
RS422V4N081	2 x 8	Vertical	9 Pin D-Sub	1
RS422H4N161	2 x 16	Horizontal	9 Pin D-Sub	1
RS422H4N162	2 x 16	Horizontal	9 Pin D-Sub	2
RS422V4N161	2 x 16	Vertical	9 Pin D-Sub	1
RS422V4N162	2 x 16	Vertical	9 Pin D-Sub	2
RS422H4N242	2 x 24	Horizontal	9 Pin D-Sub	2
RS422V4N242	2 x 24	Vertical	9 Pin D-Sub	2
RS422V4N322	2 x 32	Vertical	9 Pin D-Sub	2

*Add "N" for non-normalled version

Features and Benefits

- Unit Features either 8,16, 24, or 32 TT style jacks on the front Panels, to a 9 pin D-Sub.
- All versions utilize low capacitance internal wiring for maximum performance of transferring data
- All standard units are available 1 or 2 rack units high (1.5 RU available by request)
- Rugged, attractive black epoxy finished steel frame chassis

Specifications

Electrical

Internal Wiring:

24 AWG Solid TC, foils shield

Nom Capacitance: 11.5 pF/ft between conductors

21.3 pF/ft between one conductor and conductor connected to the shield

Nom. Impedance: 110 Ohms

Switche

RS 422 Data Patchbay Series



RS422V4N32
32 Vertical Paired Jacks
Front and Back Views



RS422H4N24
24 Horizontal Paired Jacks
Front and Back Views

DIMENSIONS ARE FOR REFERENCE ONLY

Inch
(mm)

Switchcraft®

w w w . s w i t c h c r a f t . c o m

5555 North Elston Avenue / Chicago, IL 60630
Phone: 773-792-2700 / Fax: 773-792-2129

14 MTP48K Wired Series

Features and Benefits

- Unit features 48 MT style jacks in either 1RU (1.75" H) or 2RU (3.5" H) spaces
- All versions utilize AES/EBU wiring for complete digital compatibility
- Attractive, corrosion resistant nickel-plated, steel frame jacks
- Gold-plated switching contacts reduce contact resistance, improve reliability
- Rugged, attractive black epoxy-finished steel chassis
- Extra wide designation strips for easy channel identification
- 1RU version configurations include normals strapped and normals brought out
- 2RU version configurations include normals strapped, normals brought out, and sleeve normals brought out

Specifications

Materials

Jacks

- Frame: Nickel-plated steel
- Bushing: Nickel-plated brass
- Tip, Ring and Shunt Springs: Nickel silver with welded contacts
- Assembly Screws: Zinc-plated steel
- Welded Contacts: Gold alloy

Panel

- Front Channel: Black anodized aluminum
- Frame: C.R.S. black epoxy painted
- Designation Strips: Black polycarbonate 94V-0
- Designation Strip Covers: Clear polycarbonate
- Jack Inserts: Thermoplastic polyester



The MTP Series was developed with the AES/EBU digital standard in mind. All versions are made with 110 Ohm cabling inside as a standard. Available in a wide variety of configurations.

Mechanical

- Life: 30,000 cycles
- Insertion Force: 7 lbs. maximum
- Withdrawal Force: 1 lb. minimum
- Environmental: 0°C to +50°C

Electrical

- Contact Resistance: 30 milliohms maximum initial

- Insulation Resistance: 10,000 megohms maximum
- Dielectric Withstanding Voltage: 500 VAC at 60 Hz
- Working Voltage: 140 VDC maximum
- Current Rating: 100 milliamps

Ordering Information

Part Number	Type of Jack	No. of Jacks	Description
MTP48K1NS	MT	48	1.75" High, normals strapped
MTP48K3NS	MT	48	3.5" High, normals strapped
MTP48K1NO	MT	48	1.75" High, normals brought out
MTP48K3NO	MT	48	3.5" High, normals brought out
MTP48K3SNO	MT	48	3.5" High, sleeve normals out

PATCHBAYS

MTP48K Wired Series 15



NORMALS OUT



NORMALS AT JACKS



FULL SLEEVE NORMALS OUT

DIMENSIONS ARE FOR REFERENCE ONLY $\frac{\text{Inch}}{\text{(mm)}}$

16 TTPW96K Wired Series

Features and Benefits

- Unit features 96 TT style jacks in 2RU (3.5"H) space
- Utilizes AES/EBU wiring for complete digital compatibility
- Attractive, corrosion resistant nickel-plated, steel frame jacks
- Gold-plated switching contacts reduce contact resistance, improve reliability
- Rugged, attractive black epoxy-finished steel chassis
- Extra wide designation strips for easy channel identification

Specifications

Materials

Jacks

- Frame: Nickel-plated steel
- Bushing: Nickel-plated brass
- Tip, Ring and Shunt Springs: Nickel silver with welded contacts
- Assembly Screws: Zinc-plated steel
- Welded Contacts: Gold alloy

Panel

- Front Channel: Black anodized aluminum
- Frame: C.R.S. black epoxy painted
- Designation Strips: Black polycarbonate 94V-0
- Designation Strip Covers: Clear polycarbonate
- Jack Inserts: Thermoplastic polyester

Mechanical

- Life: 30,000 cycles
- Insertion Force: 7 lbs. maximum
- Withdrawal Force: 1 lb. minimum
- Environmental: 0°C to +50°C

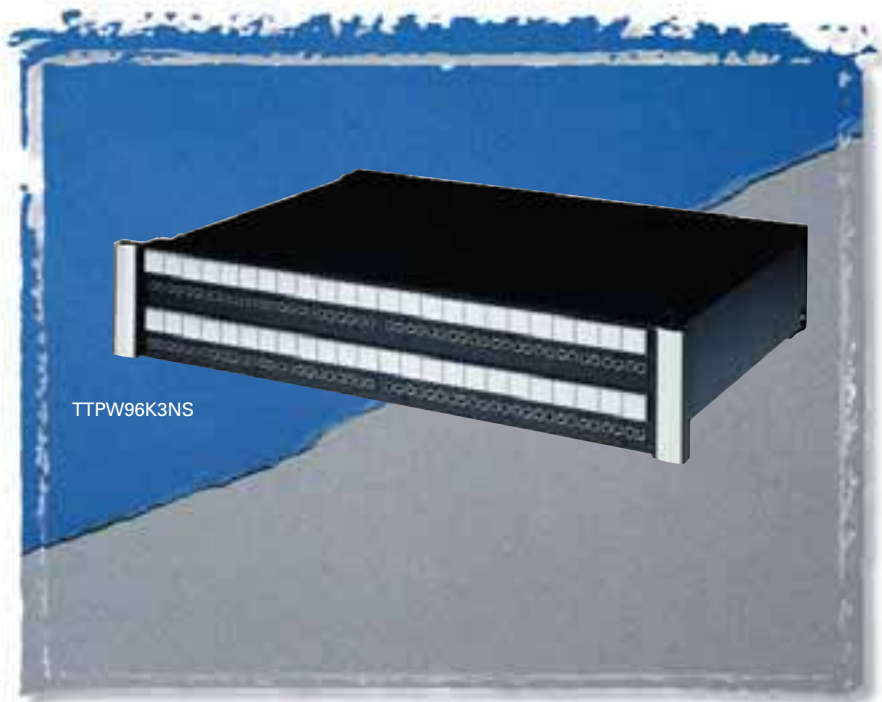

The TTPW96K Series was developed with the AES/EBU digital standard in mind. As a standard, the TTPW96K utilizes 110 Ohm cabling inside.

Electrical

- Contact Resistance: 30 milliohms maximum initial
- Insulation Resistance: 10,000 megohms maximum
- Dielectric Withstanding Voltage: 500 VAC at 60 Hz
- Working Voltage: 140 VDC maximum
- Current Rating: 100 milliamps

Ordering Information

Part Number	Type of Jack	No. of Jacks	Description
TTPW96K1NN	TT	96	1.75" High, non-normals
TTPW96K1HN	TT	96	1.75" High, half normals
TTPW96K1NS	TT	96	1.75" High, normals strapped
TTPW96K3NN	TT	96	3.5" High, non-normals
TTPW96K3HN	TT	96	3.5" High, half normals
TTPW96K3NS	TT	96	3.5" High, normals strapped

PATCHBAYS

TTPW96K Wired Series 17

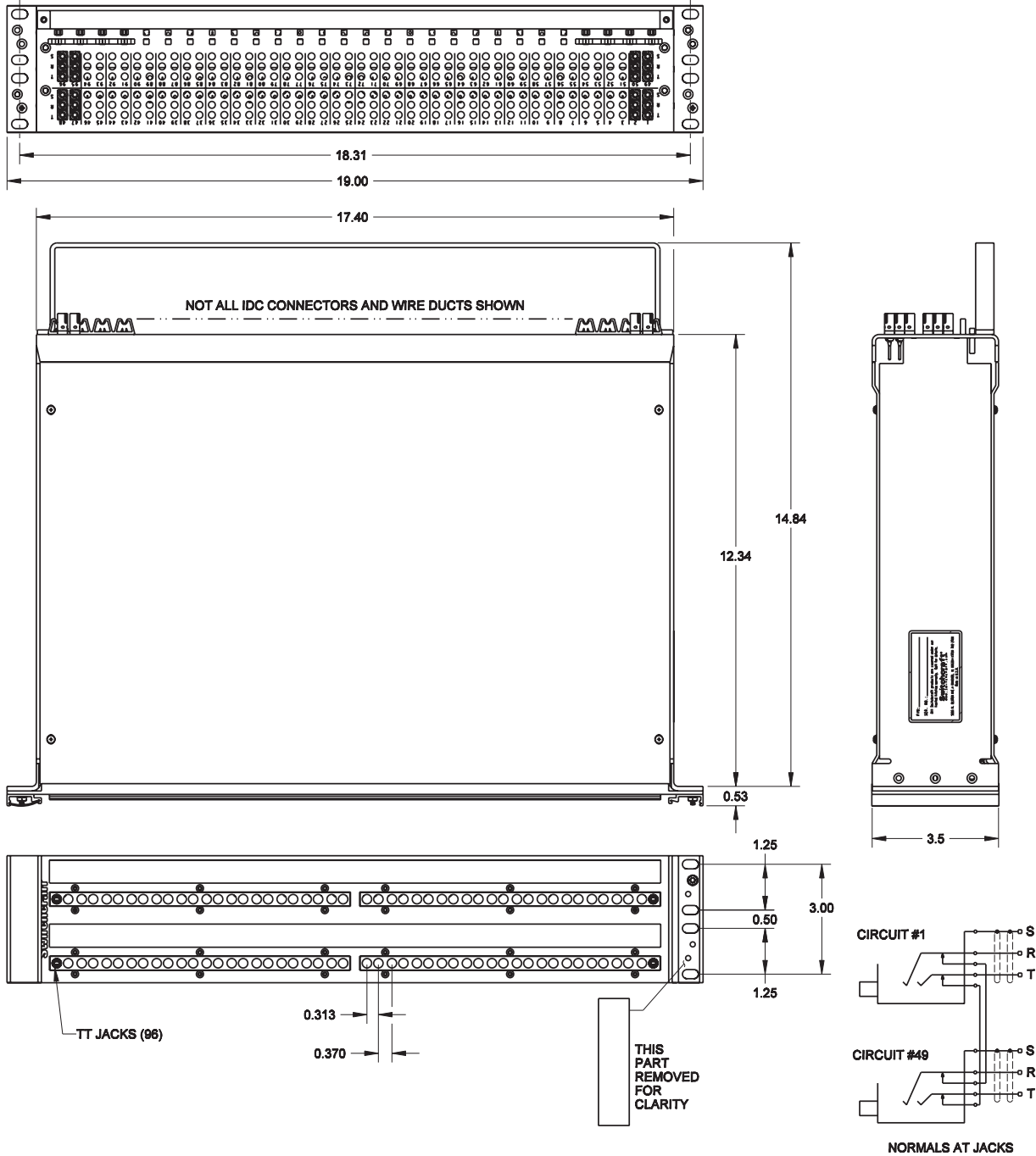

DIMENSIONS ARE FOR REFERENCE ONLY

Inch
(mm)

Switchcraft
www.switchcraft.com

5555 North Elston Avenue / Chicago, IL 60630
Phone: 773-792-2700 / Fax: 773-792-2129

PATCHBAYS

18 MTPBP/TTPBP Backpanel Series

Features and Benefits

- Allows for custom patchbay configurations or central patching points
- PPTs have IDCs on both sides for easy installation
- Rugged, attractive black epoxy-finished steel chassis
- Cable trays allow for mounting and securing terminated cable

Specifications

Panel thickness: .093"
 Mounting hole diameter: .187"
 Mounting hole spacing (48 IDCs/row): .340" (Horizontal) x .275" (Vertical)
 Mounting hole spacing (52 IDCs/row): .320" (Horizontal) x .275" (Vertical)
 Wire size: #22, 24, 26 AWG
 Stranded or Solid (IDC termination)

Materials

Housing: Thermoplastic (UL 94V-0)
 Contacts: High strength copper alloy
 Backpanels: Black Epoxy coated C.R.S.
 Cable Tray: Black Epoxy coated C.R.S.



The Backpanel Series offers the end user the flexibility of configuring their own patchbay, or to use as a central patchpoint location. The backpanels utilize the PPT punchdown and come with a rugged cable tray.

Ordering Information

Part Number	Sets of PPT Terminals	Height	Description
MTP48K3BPNS	48	3.5"	T, R, S
MTP48K3PBNO	48	3.5"	T, R, S, TN, RN
MTP52K3BPNO	52	3.5"	T, R, S, TN, RN
MTP24K7	24 x 2	7.0"	+, -, S
TTP96K3BPNS	96	3.5"	T, R, S
TTP96K5BPNS	96 x 2	5.25"	T, R, S, TN, RN



DIMENSIONS ARE FOR REFERENCE ONLY

Inch
(mm)

Switchcraft
www.switchcraft.com

5555 North Elston Avenue / Chicago, IL 60630
Phone: 773-792-2700 / Fax: 773-792-2129



PATCHBAYS

20 TT96 EDAC Series

Features and Benefits

- Attractive, corrosion-resistant, nickel-plated jacks
- Steel frame jacks for superior jack life
- Extra wide labeling strips provide maximum space and two vertical strips, one at each side
- Rugged, attractive black anodized aluminum face will not break
- Two configurations available:
 - Normals brought out
 - Normaled at jacks
- Gold switching contacts for long-term reliability
- Jacks paired for easy identification of left and right channels
- Connectorized by EDAC® connectors for ease of termination by customer

Specifications

Materials

Jacks

Frame: Nickel-plated steel
 Bushing: Nickel-plated brass
 Tip, Ring and Shunt Springs: Nickel silver with welded contacts
 Assembly Screws: Zinc-plated steel
 Welded Contacts: Gold alloy

Panel

Front Channel: Black anodized aluminum
 Frame & Cover: C.R.S. black epoxy painted
 Designation Strips: Black polycarbonate 94V-0
 Designation Strip Covers: Clear polycarbonate
 Jack Inserts: Polyester

EDAC Connector

Housing: Thermoplastic, UL94V-0
 Contacts: Gold plated phosphor bronze

Mechanical

Life: 30,000 cycles
 Insertion Force: 7 lbs. maximum
 Withdrawal Force: 1 lb. minimum
 Operating: -20°C to +65°C



The TT96EDAC Series offers the convenience of EDAC® connectors on the back of the panel for easy installation. Available in normals strapped and normals brought out, both wired to the SAC code of wiring. We also offer custom wiring configurations. Contact the factory for details.

Electrical

Contact Resistance: 30 milliohms maximum initial
 Insulation Resistance: 10,000 megohms
 Dielectric Withstanding Voltage: 500VAC at 60 Hz
 Working Voltage: 140VDC
 Current Rating: 100 milliamps

EDAC Mating Plugs

Part Number	Description
516-090-000-301	90 Pin male w/ screw
516-090-000-302	90 Pin male w/ nut
516-120-000-101	120 Pin male w/ screw
516-120-000-102	120 Pin male w/ nut
516-290-500	Terminal solder-style
516-290-590	Terminal crimp-style

Ordering Information

Part Number	Type of Jack	No. of Jacks	Description
TT96EDACNO	TT	96	Normals Brought Out (120 pin EDAC)
TT96EDACNS	TT	96	Normals Strapped (90 pin EDAC)

Switel

PATCHBAYS

TT96 EDAC Series



Standard Audio Configuration Wiring (S.A.C.)
90 Pin Plug Connector
(Normals at jacks)

90 PIN CONNECTOR PIN-OUT			
JACK No.	TIP	RING	SLEEVE
1	A	H	R
JACKS #2 THRU #6 PATTERN CONTINUES TO F, N, W			
7	X	AE	AM
JACKS #8 THRU #12 PATTERN CONTINUES TO AC, AL, AT			
13	BJ	BS	BY
JACKS #14 THRU #18 PATTERN CONTINUES TO BP, BX, CD			
19	CF	CN	CW
JACKS #20 THRU #24 PATTERN CONTINUES TO CM, CU, DV			

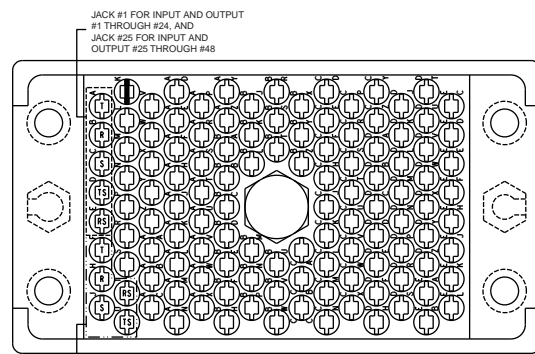

Standard Audio Configuration Wiring (S.A.C.)
120 Pin Plug Connector
(Normals brought out)

120 PIN CONNECTOR PIN-OUT					
JACK No.	TIP	RING	SLEEVE	TIP SHUNT	RING SHUNT
1	A	B	C	D	E
JACKS #2 THRU #6 PATTERN CONTINUES TO AN, AM, AL, AK, AJ					
7	AH	AF	AE	AD	AP
JACKS #8 THRU #12 PATTERN CONTINUES TO BN, BP, BW, BU					
13	BT	BS	BR	BX	BY
JACKS #14 THRU #18 PATTERN CONTINUES TO CX, DH, DF, DE, DD					
19	DC	DB	DA	CZ	CY
JACKS #20 THRU #24 PATTERN CONTINUES TO EF, EH, EJ, EK, EL					

DIMENSIONS ARE FOR REFERENCE ONLY

Inch
(mm)

PATCHBAYS

22 TTP96K Patchkit Series

Features and Benefits

- Kit features 96 TT jacks in one rack space (1.75" high) or two rack spaces (3.5" high)
- Jack blocks can be removed from the front for easy soldering
- Dust tray limits dirt, dust and contamination of jack terminals
- Wire management straps are adjustable and reusable
- Attractive, corrosion resistant nickel-plated jacks
- Steel frame jack for superior jack life
- Extra wide labeling strips provide maximum space
- Rugged, attractive black anodized aluminum face will not break or rust
- Three jack configurations available for the exact switching arrangement you need: full normal, half normal, and non-normal (open circuit)
- Fanned solder terminals for easier solder connections
- Gold switching contacts for long-term reliability in normal-through connections

Specifications

Materials

Jacks

Frame: Nickel-plated steel
 Bushing: Nickel-plated brass
 Tip, Ring and Shunt Springs:
 Nickel silver with welded contacts

Assembly Screws: Nickel-plated steel

Welded Contacts: Gold alloy

Panel

Front Channel: Black anodized aluminum
 Frame: C.R.S. black epoxy painted
 Designation Strips: Black polycarbonate 94V-0
 Designation Strip Covers: Clear polycarbonate
 Jack Inserts: Thermoplastic polyester



The TTP96K Patchkit Series offers the end user a rugged cable tray to support rear cabling. Heavy duty construction takes weight off the back of the jacks for increased reliability. Available in 1.75" or 3.5" height versions.

Mechanical

Life: 30,000 cycles
 Insertion Force: 7 lbs. maximum
 Withdrawal Force: 1 lb. minimum
 Environmental: 0°C to +50°C

Electrical

Contact Resistance: 30 milliohms maximum initial
 Insulation Resistance:
 10,000 megohms maximum
 Dielectric Withstanding Voltage:
 500VAC at 60 Hz
 Working Voltage: 140VDC maximum
 Current Rating: 100 milliamps

Ordering Information

Part Number	Type of Jack	No. of Jacks	Description
TTP96K1FN	TT	96	1.75" High, full normals
TTP96K1HN	TT	96	1.75" High, half normal
TTP96K1NN	TT	96	1.75" High, no normals
TTP96K3FN	TT	96	3.5" High, full normals
TTP96K3HN	TT	96	3.5" High, half normals
TTP96K3NN	TT	96	3.5" High, no normals

Switel



FULL NORMAL
TTP96K1FN
TTP96K3FN



HALF NORMAL
TTP96K1HN
TTP96K3HN



OPEN CIRCUIT
TTP96K1NN
TTP96K3NN

DIMENSIONS ARE FOR REFERENCE ONLY

Inch
(mm)

PATCHBAYS

24 MT48K/MT52K Patchkit Series

Features and Benefits

- Kit features 48 1/4" longframe jacks in one rack space (1" high) or in two rack spaces (3" high) or 52 1/4" longframe jacks in one rack space (1" high)
- Allows user to add cable and termination panel
- Removable jack panel from the front allows easy soldering of wire connections
- Jacks have gold switching contacts
- Fanned solder terminals for easier soldering
- Offset ground lugs allow easy bussing of ground with one wire
- Jacks have a nickel-plated frame and assembly screws
- Wire management straps are reusable and adjustable



The MT48/52K Patchkit Series offers the end user a rugged cable tray to support rear cabling. Heavy duty construction takes weight off the back of the jacks for increased reliability. Available in 1.75" or 3.5" height versions.

Specifications

Materials

Jacks

Frame: Stamped nickel-plated steel

Bushing: Nickel-plated brass

Tip, Ring and Shunt Springs:

Nickel silver with welded contacts

Assembly Screws: Nickel-plated steel

Welded Contacts: Gold alloy

Panel

Front Panel: Thermoplastic

Frame: C.R.S. black epoxy paint

Designation Strips: Black polycarbonate 94V-0

Designation Strip Covers: Clear polycarbonate

Mechanical

Life: 30,000 cycles

Insertion Force: 7 lbs. maximum

Withdrawal Force: 1 lb. minimum

Operating: 0°C to +50°C

Electrical

Contact Resistance: 30 milliohms maximum initial

Insulation Resistance: 10,000 megohms maximum

Dielectric Withstanding Voltage: 500VAC at 60 Hz

Working Voltage: 140VDC maximum

Current Rating: 100 milliamps

Ordering Information

Part Number	Type of Jack	No. of Jacks	Height	Description
MT48K1NS	MT	48	1.75"	Normals strapped
MT48K1FN	MT	48	1.75"	Full normals
MT48K1HN	MT	48	1.75"	Half normals
MT48K1NN	MT	48	1.75"	No normals
MT52K1NS	MT	52	1.75"	Normals strapped
MT52K1FN	MT	52	1.75"	Full normals
MT52K1HN	MT	52	1.75"	Half normals
MT52K1NN	MT	52	1.75"	No normals
MT48K3FN	MT	48	3.5"	Full normals
MT48K3HN	MT	48	3.5"	Half normals
MT48K3NN	MT	48	3.5"	No normals
MT52K3FN	MT	52	3.5"	Full normals
MT52K3HN	MT	52	3.5"	Half normals
MT52K3NN	MT	52	3.5"	No normals

Switel

MT48K/MT52K Patchkit Series 25

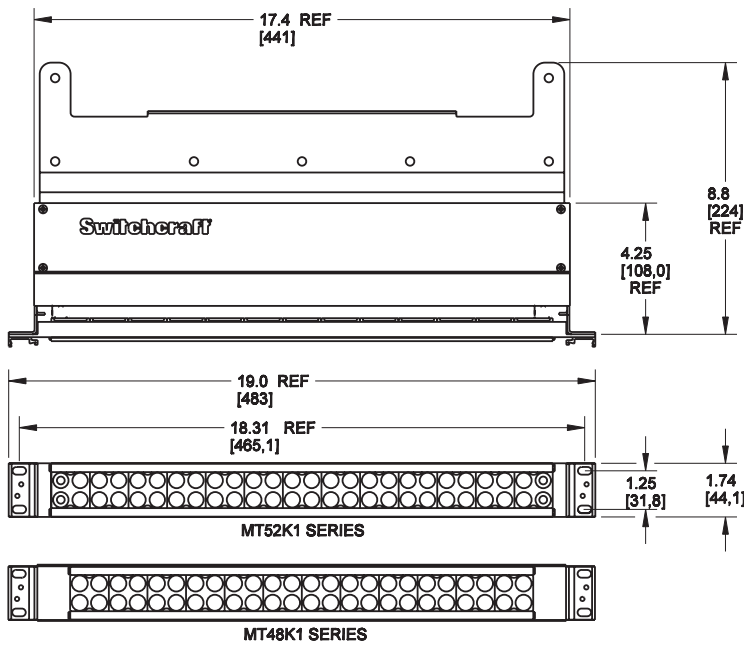
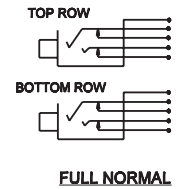
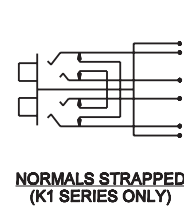
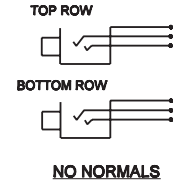
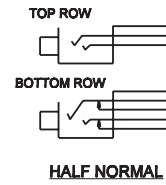
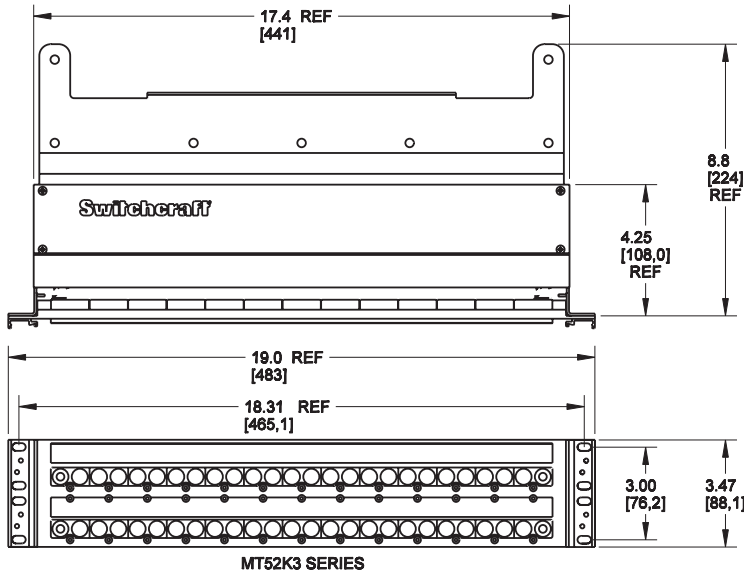

DIMENSIONS ARE FOR REFERENCE ONLY

Inch
(mm)

Switchcraft
www.switchcraft.com

5555 North Elston Avenue / Chicago, IL 60630
Phone: 773-792-2700 / Fax: 773-792-2129

PATCHBAYS

26 MT48/MT52 Patchbay Series

Features and Benefits

- Units feature either 48 or 52 MT Jax®
- Steel frame jacks for superior jack life
- Attractive, corrosion resistant nickel-plated jacks
- Gold switching contacts for long-term reliability in normal-through connections
- Offset ground terminal for ease in making common ground buss connections
- Fanned solder terminals for easier solder connections
- Cable tie bar takes the weight of cables off the jacks
- Four jack configurations available for the exact switching arrangement: full normal, half normal, non-normal, and normals strapped

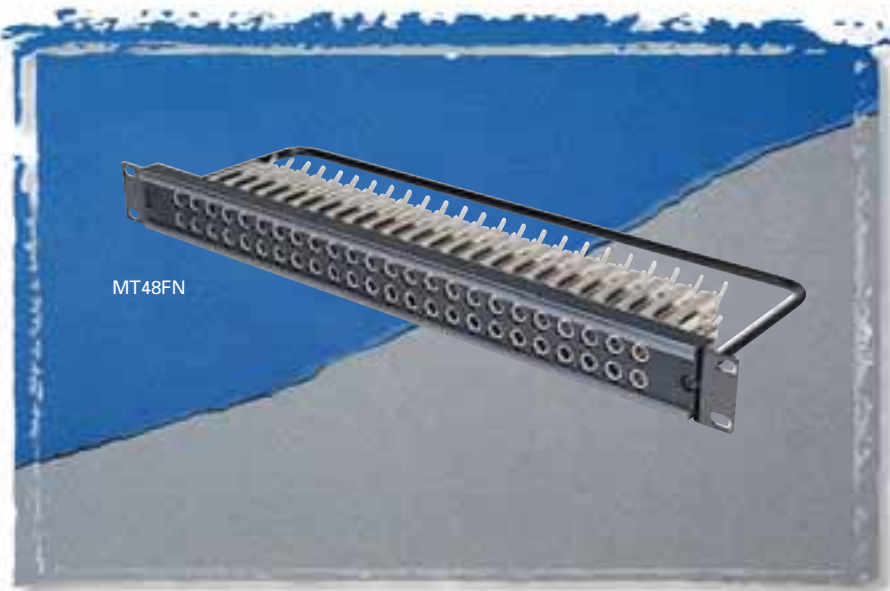

The MT48/52 Series patchbays offer a rugged cable tie bar to support rear cabling. Also available is the normals strapped configuration which has the shunts or normals tied together, top to bottom jacks.

Specifications

Materials

Jacks

- Frame: Steel, nickel-plated
- Bushing: Brass, nickel-plated
- Springs: Nickel silver, solder lugs
- Ground Terminal: Nickel silver, solder lugs
- Switching Contacts: Welded, gold alloy
- Insulation: Phenolic spacers, rigid PVC tubing through stack
- Screws: Steel, nickel-plated

Panel

- Jack Panel: Thermoplastic
- Cable Support Bracket: 5/16" diameter black epoxy painted steel rod
- Screws (designation strip): Steel, black zinc-plated
- Screws (mounting jack): Steel, nickel plated
- Kwik-change® Designation Strip: Extruded aluminum, black anodized
- Marking Strip: White plastic, matte finish
- Marking Strip Cover: Clear, extruded plastic

Mechanical

- Life: 30,000 cycles
- Insertion Force: 7 lbs. maximum
- Withdrawal Force: 1 lb. minimum
- Operating: 0°C to +50°C

Electrical

- Contact Resistance: 30 milliohms maximum initial
- Insulation Resistance: 10,000 megohms maximum
- Dielectric Withstanding Voltage: 500VAC at 60 Hz
- Working Voltage: 140VDC maximum
- Current Rating: 100 milliamps

Ordering Information

Part Number	Type of Jack	No. of Jacks	Description
MT48FN	MT	48	Full normals
MT48HN	MT	48	Half normals
MT48NN	MT	48	No normals
MT48NS	MT	48	Normals strapped
MT52FN	MT	52	Full normals
MT52HN	MT	52	Half normals
MT52NN	MT	52	No normals
MT52NS	MT	52	Normals strapped

Switche

MT48/MT52 Patchbay Series



YMT332BN

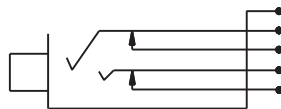

YMT334BN



YMT389N

JACK SCHEMATICS
"N" SUFFIX DENOTES WELDED GOLD CONTACTS
AND NICKEL-PLATED FRAME

DIMENSIONS ARE FOR REFERENCE ONLY $\frac{\text{Inch}}{\text{(mm)}}$

PATCHBAYS

28 TTP96AS Patchbay Series

Features and Benefits

- Unit features 96 TT jacks
- Attractive, corrosion resistant nickel-plated jacks
- Steel frame jack for superior jack life
- Extra wide labeling strips provide maximum space
- Rugged cable tie bar takes the weight of cables off the jacks
- Rugged, attractive black anodized aluminum face will not break
- Three jack configurations available for the exact switching arrangement you need: full normal, half normal, and open circuit panel
- Fanned solder terminals for easier solder connections
- Offset ground terminal for ease in making common ground buss connections
- Gold switching contacts for long-term reliability in normal-through connections

Specifications

Materials

Jacks

Frame: Steel, nickel-plated
 Bushing: Nickel-plated copper alloy
 Springs: Copper alloy solder lugs
 Ground Terminal: Steel, tin electrodeposited
 Switching Contacts: Welded, gold alloy inlay over palladium base
 Insulation: Rigid plastic spacers, rigid PVC tubing through stack
 Screws: Steel, plated

Panel

Frame: Black anodized aluminum
 Inserts: Polyester, glass filled, 94V-0
 Cable Support Bar: Cold rolled steel, nickel-plated
 Designation Strips: Thermoplastic, 94V-0



The TTP96AS Series of patchbays offer a rugged cable tie bar to support rear cabling.

Designation Strip Covers: Clear thermoplastic, SE-1
 Marking Strip: Rigid vinylite
 Jack Mounting Screws: Steel, plated
 Screws: Steel, black plated

Mechanical

Life: 30,000 cycles
 Insertion Force: 7 lbs. maximum
 Withdrawal Force: 1 lb. minimum
 Environmental: 0°C to +50°C

Electrical

Contact Resistance: 30 milliohms maximum initial
 Insulation Resistance: 10,000 megohms maximum
 Dielectric Withstanding Voltage: 500VAC at 60 Hz
 Working Voltage: 140VDC maximum
 Current Rating: 100 milliamps

Ordering Information

Part Number	Type of Jack	No. of Jacks	Description
TTP96ASFN	TT	96	Full normals
TTP96ASHN	TT	96	Half normals
TTP96ASNN	TT	96	No normals

Switel

PATCHBAYS

TTP96AS Patchbay Series

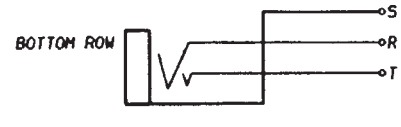
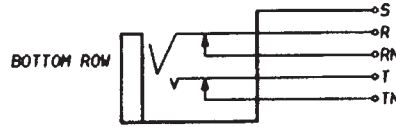
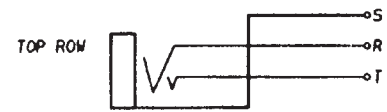
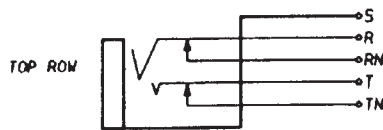
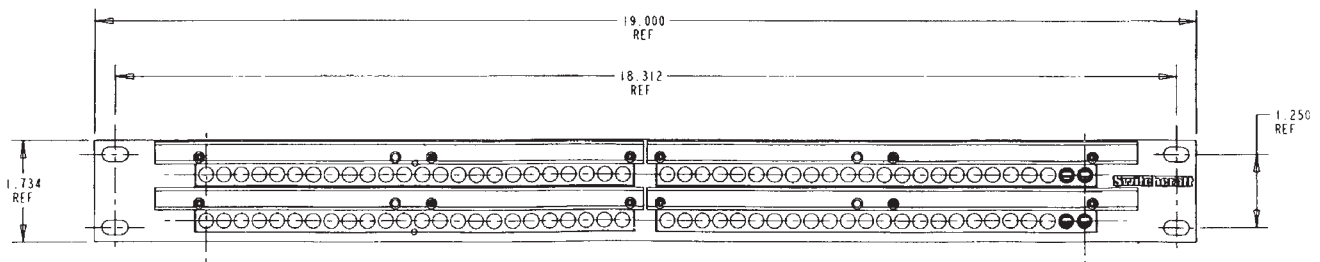
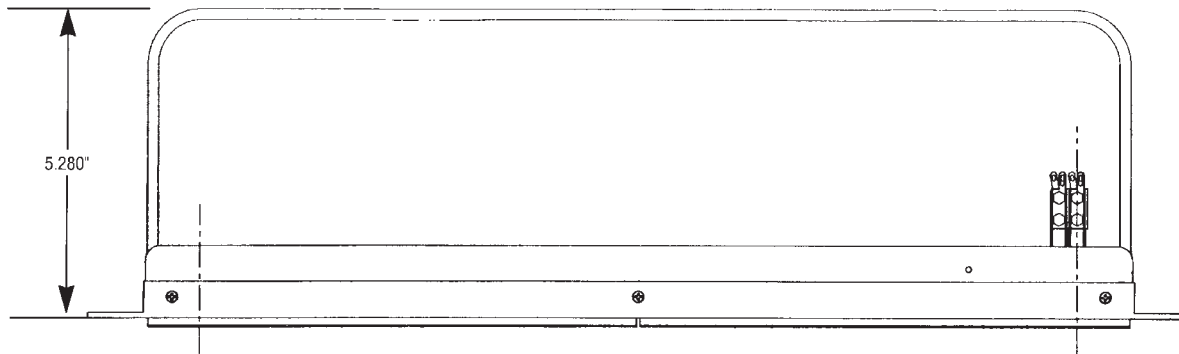

TTP96ASFN

TTP96ASHN

TTP96ASNN

DIMENSIONS ARE FOR REFERENCE ONLY

Inch
(mm)

PATCHBAYS

30 HPC Patchbay Series

Features and Benefits

- Available in 1RU or 2RU versions
- Available with or without connectors
- HPC Series connectors are compatible with Neutrik Speakon® connectors
- Cable tie bar takes weight of the cables off the terminations
- Rugged aluminum channel
- Silk-screen designation area makes it easy to re-label channels

Panel Materials

Housing: Thermoplastic UL 94V-0 rated
 Contacts: Silver-plated over copper alloy
 Frame: Aluminum, black anodized
 Cable Tie Bar: Steel, black epoxy

HP Connector Specifications

Mechanical

Shock: Per Mil-Std 202, Method 213B, Cond. K
 Vibration: Mil-Std 202, Method 201A
 Life: 1,000 rotational cycles
 Cable Range (cord mount): 10AWG, 0.560" cable OD maximum

Electrical

Voltage Rating: 1,500 AC RMS, per Mil-Std 202, Method 301
 Current Rating (Faston® terminals): 50A RMS w/10AWG wire, normal ambient, per UL 1977
 Current Rating (PC terminals): 30A per UL 1977
 Contact Resistance: 1mΩ, 1.5mΩ after 1,000 insertion/withdrawals
 Insulation Resistance: .2TΩ

Environmental

Salt Spray: Mil-Std 202, Method 101D, Cond.B
 Thermal Shock: Mil-Std 202, Method 107G
 Temperature Limits: -55°C to +85°C
 Moisture Resistance: Mil-Std 202, Method 106E
 Life @ Ambient Temperature: Mil-Std 202, Method 108A
 Touchproof: IEC 65 and 1010-1
 IP Rating: IEC 529, IP 25



The HPC Patchbay features a 19" rack unit loaded with HPC Series connectors. Available with either 0.250" Faston® terminals or 0.187" Faston® terminals. One rack unit height versions come with 12 HPC connectors, two rack unit height versions come with 24 HPC connectors. All versions have a rugged cable tie bar, which takes the weight of the cabling away from the connections.

Materials

Housings: Thermoplastic UL 94V-0 rated
 Seal Rings: Thermoplastic rubber
 Contacts: Silver-plated over copper alloy

Ordering Information

Part Number	Height	Description
HPCPK112F	1.75"	12 connectors, 0.250" Fastons
HPCPK112F1	1.75"	12 connectors, 0.187" Fastons
HPCPK1B	1.75"	Blank panel
HPCPK324F	3.50"	24 connectors, 0.250" Fastons
HPCPK324F1	3.50"	24 connectors, 0.187" Fastons
HPCPK3B	3.50"	Blank panel

Switchtel

PATCHBAYS

HPC Patchbay Series 31



DIMENSIONS ARE FOR REFERENCE ONLY

Inch
(mm)

Switchcraft
www.switchcraft.com

5555 North Elston Avenue / Chicago, IL 60630
Phone: 773-792-2700 / Fax: 773-792-2129

PATCHBAYS

32 Q-G® Patchbay Series

Features and Benefits

- Available in 1RU or 2RU versions
- Available with or without the connectors
- E Series connectors are silver-plated, 3 pins/contacts with black finish
- Cable tie bar takes the weight of the cables off the solder terminations
- Rugged aluminum channel increases durability
- Silk-screen designation area makes it easy to re-label channels

Specifications

Materials

Connectors

- Housing: Die-cast, black velvet finish
- Inserts: Glass-filled thermoplastic
- Pin/Contacts: Copper alloy, silver-plated
- Latch Release: Steel, nickel-plated
- Insert Locking Cam: Die-cast zinc

Frame

- Aluminum, black anodized

Cable Tie Bar

- Steel, black epoxy



The QG® Patchbay features a 19" rack unit loaded with E Series QG® connectors. These XLR's have the same panel cut-out, male or female, silver-plated pins or contacts, and a black finish. All connectors have solder cup terminals for easy soldering and the inserts are removable from the back, allowing for easy changes. The one rack unit height version comes with 16 male, or 16 female, or 8 male and 8 female connectors. The two rack unit version comes with 16 male and 16 female connectors. We also offer the unit without connectors, but with the panel cut-outs already punched out.

All versions have a rugged cable tie bar, which takes the weight of the cabling away from the solder connections.

Ordering Information

Part Number	Height	Description
QGPK116FB	1.75"	16 female
QGPK116MB	1.75"	16 male
QGPK18M8FB	1.75"	8 male, 8 female
QGPK332MFB	3.5"	16 female(top), 16 male (bottom)
QGPK1B	1.75"	Blank panel
QGPK3B	3.5"	Blank panel

Switchtel

PATCHBAYS

Q-G® Patchbay Series 33



DIMENSIONS ARE FOR REFERENCE ONLY Inch
(mm)

PATCHBAYS

34 VPP Video Patchbay Series

Features and Benefits

- HD Series rated from DC to 3.0 GHz
- SD Series has a bandwidth from DC to 1.75GHz
- Black thermoplastic modules insulate jacks from chassis
- Jacks feature rugged heavy duty housings

Video Jack Specifications

Electrical

Rated Bandwidth: 3.0 GHz (HD),
1.75 GHz (SD)
Characteristic Impedance:
75 ohms
Return Loss: Better than -15 dB
Insertion Loss: Better than -.5 dB
Contact Resistance: Less than 20 milliohms
Termination Resistance:
75 W, ±1%
Center Conductor: Accepts .090 pin diameter

Mechanical

Mechanical Shock: Per MIL-STD-202, Method 213, Test condition I
Vibration: Per MIL-STD-202, Method 201
Life Cycle: 30,000

Materials

Housing: Zinc alloy, nickel plated
Center Contacts: Copper alloy, gold plated
Switching Springs: Copper alloy, gold plated
Grounding Contacts:
HD Series - Copper alloy, gold plated
SD Series - Copper alloy, nickel plated
Insulators: Thermoplastic, UL 94V-0 rated

Environmental

Operating Temperature:
- 40°C to 65°C
Storage Temperature:
- 55°C to 85°C
Thermal Shock:
Per MIL-STD-202, Method 107
Moisture and Humidity:
Per MIL-STD-202, Method 106



The VPP Series video patchbays offer a wide variety of options for video patching. The HD Series meets SMPTE 292M specifications for high definition video signaling, covering a bandwidth range from DC to 3.0GHz. The SD Series is perfect for serial digital, with a bandwidth from DC to 1.75GHz. Both come in either terminated or non-terminated, 24 or 26 jacks, 1.75" or 3.5" heights.

Ordering Information

Part Number	Type of Jack	No. of Jacks	Height	Description
VPP24K1HD*75T	HD	24	1.75"	Terminated
VPP24K1HD*NT	HD	24	1.75"	Non-term
VPP24K1SD*75T	SD	24	1.75"	Terminated
VPP24K1SD*NT	SD	24	1.75"	Non-term
VPP26K1HD*75T	HD	26	1.75"	Terminated
VPP26K1HD*NT	HD	26	1.75"	Non-term
VPP26K1SD*75T	SD	26	1.75"	Terminated
VPP26K1SD*NT	SD	26	1.75"	Non-term
VPP24K3HD*75T	HD	24	3.5"	Terminated
VPP24K3HD*NT	HD	24	3.5"	Non-term
VPP24K3SD*75T	SD	24	3.5"	Terminated
VPP24K3SD*NT	SD	24	3.5"	Non-term
VPP26K3HD*75T	HD	26	3.5"	Terminated
VPP26K3HD*NT	HD	26	3.5"	Non-term
VPP26K3SD*75T	SD	26	3.5"	Terminated
VPP26K3SD*NT	SD	26	3.5"	Non-term

* Add "N" for non-normalled version

See Page 36 for Individual Jacks Ordering Information

Switel

VPP Video Patchbay Series 35



NON-NORMALLED
TERMINATED



NORMALLED
TERMINATED



NORMALLED
NON-TERMINATED



NON-NORMALLED
NON-TERMINATED

DIMENSIONS ARE FOR REFERENCE ONLY

Inch
(mm)

Switchcraft®

www.switchcraft.com

5555 North Elston Avenue / Chicago, IL 60630
Phone: 773-792-2700 / Fax: 773-792-2129

PATCHBAYS

36 VPP Video Patchbay Series

Ordering - Individual Jacks

Part Number	Type	Description
VJHD*75TX	HD	Terminated
VJHD*NTX	HD	Non-terminated
VJSD*75TX	SD	Terminated
VJSD*NTX	SD	Non-terminated

* Add "N" for non-normalled version

SMITH CHART (TYPICAL)



RETURN LOSS (TYPICAL)



INSERTION LOSS (TYPICAL)



MVP Midsize Video Patchbay Series

Features and Benefits

- Midsize video jacks rated from DC to 3 GHz
- 32 midsize jacks mounted either 1RU, 1.5RU or 2RU panel
- Available in terminated or non-terminated configurations

Specifications

Materials

Frame: Aluminum, black anodized
 Designation Strips: Vinylite, white
 Designation Strip Covers: Lexan, transparent
 Jack Inserts: Thermoplastic, UL 94V-0 rated

Midsize Video Jack Specifications

Electrical

Rated Bandwidth: 3.0 GHz
 Characteristic Impedance: 75 ohms
 Return Loss: See Typical Return Loss Chart
 Insertion Loss: See Typical Insertion Loss Chart
 Contact Resistance: Less than 20 milliohms
 Termination Resistance: 75 W, ±1%
 Center Conductor: Accepts .048 pin diameter

Mechanical

Mechanical Shock: Per MIL-STD-202, Method 213, Test condition I
 Vibration: Per MIL-STD-202, Method 201
 Life Cycle: 30,000

Materials

Housing: Zinc alloy, nickel plated
 Center Contacts: Copper alloy, gold plated

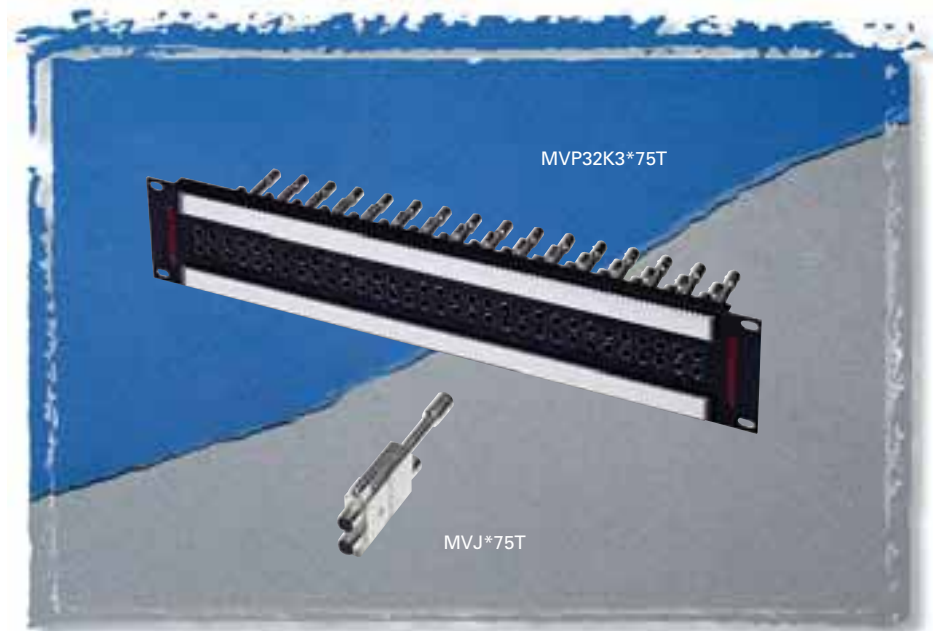

The MVP Series video patchbays offer outstanding performance and high density. Patchbays consist of 32 jacks in either 1RU or 2RU heights, jacks come either terminated or non-terminated. These jacks are rated from DC to 3 GHz, and are rated at 30,000 lifecycles. The 1.5RU and 2RU come with cable tie bars.

Environmental

Switching Springs: Copper alloy, gold plated
 Grounding Contacts: Copper alloy, gold plated
 BNC Insulators: Teflon
 Actuators: Thermoplastic, UL94V-0 rated

Operating Temperature: -40°C to 65°C
 Storage Temperature: -55°C to 85°C
 Thermal Shock: Per MIL-STD-202, Method 107
 Moisture and Humidity: Per MIL-STD-202, Method 106

Ordering Information

Part Number	Type of Jack	Height	Description
MVP32K1*75T	Midsize	1.75"	Terminated
MVP32K1*NT	Midsize	1.75"	Non-terminated
MVP32K2*75T	Midsize	2.62"	Terminated
MVP32K2*NT	Midsize	2.62"	Non-terminated
MVP32K3*75T	Midsize	3.5"	Terminated
MVP32K3*NT	Midsize	3.5"	Non-terminated

* Add "N" for non-normalled version

See Page 39 for Individual Midsize Jacks Ordering Information

PATCHBAYS

38 MVP Midsize Video Patchbay Series



DIMENSIONS ARE FOR REFERENCE ONLY Inch
(mm)

MVP Midsize Video Patchbay Series

Ordering - Individual Midsize Jacks

Part Number	Type	Description
MVJ*75T	HD	Terminated
MVJ*NT	HD	Non-terminated

* Add "N" for non-normalled version

SMITH CHART (TYPICAL)



RETURN LOSS (TYPICAL)



INSERTION LOSS (TYPICAL)



DIMENSIONS ARE FOR REFERENCE ONLY

Inch
(mm)

PATCHBAYS

40 VAP Video/Audio Patchbay Series

Features and Benefits

- Combines 13 video jacks and 26 long-frame audio jacks into one patchbay
- Available with either HD Series or SD Series video jacks
- All audio jacks are nickel-plated with steel frames and gold-plated switching contacts
- Audio modules consist of 4 YMT334BN jacks, video modules consist of 2 dual video jacks

Video Jack Specifications

Electrical

Rated Bandwidth: 2.4 GHz (HD),
1.75 GHz (SD)
Characteristic Impedance: 75 ohms
Return Loss: Better than -15 dB
Insertion Loss: Better than -.5 dB
Contact Resistance: Less than 20 milliohms
Termination Resistance: 75 W, ±1%
Center Conductor: Accepts .090 pin diameter

Mechanical

Mechanical Shock: Per MIL-STD-202, Method 213, Test condition I
Vibration: Per MIL-STD-202, Method 201
Life Cycle: 30,000

Materials

Housing: Zinc alloy, nickel plated
Center Contacts: Copper alloy, gold plated
Switching Springs: Copper alloy, gold plated
Grounding Contacts:
HD Series - Copper alloy, gold plated
SD Series - Copper alloy, nickel plated
Insulators: Thermoplastic, UL 94V-0 rated



The VAP Series combines audio and video in one convenient patchbay. Standard versions consist of 13 video jacks and 26 long-frame audio jacks into one unit. Options include HD Series video jacks which are rated from DC to 2.4GHz or SD Series rated from DC to 1.5GHz. Both come in either terminated or non-terminated jacks. The MT Style audio jacks all have nickel-plated steel frames and gold-plated switching contacts. Flared terminals make soldering easier. All audio jacks are T,R,S, TN, and RN. Individual modules are useful for custom configurations.

Environmental

Operating Temperature: - 40°C to 65°C
Storage Temperature: - 55°C to 85°C

Thermal Shock: Per MIL-STD-202, Method 107
Moisture and Humidity: Per MIL-STD-202, Method 106

Ordering Information

Part Number	Type of Jack	Height	Description
VAPK1HD*75T	HD	1.75"	Terminated
VAPK1HD*NT	HD	1.75"	Non-terminated
VAPK1SD*75T	SD	1.75"	Terminated
VAPK1SD*NT	SD	1.75"	Non-terminated
VAPK3HD*75T	HD	3.5"	Terminated
VAPK3HD*NT	HD	3.5"	Non-terminated
VAPK3SD*75T	SD	3.5"	Terminated
VAPK3SD*NT	SD	3.5"	Non-terminated

Modules

VMAFN	MT Style	4- YMT334BN jacks
VMVHD*75T	HD	2- HD terminated jacks
VMVHD*NT	HD	2- HD non-terminated jacks
VMVSD*75T	SD	2- SD terminated jacks
VMVSD*NT	SD	2-SD non-terminated jacks

* Add "N" for non-normalled version

See Page 36 For Video Jack Ordering Information and Page 69 For Audio Jack Ordering Information

Switel

VAP Video/Audio Patchbay Series 41



VIDEO JACK

YMT JACK

DIMENSIONS ARE FOR REFERENCE ONLY Inch
(mm)

PATCHBAYS

42 MVEZN Audio/Midsize Patchbay Series

Features and Benefits

- Combines 16 midsize video jacks and 24 dual EZ Norm bantam jacks.
- Video jacks are rated from DC to 3.0 GHZ.
- Rugged, attractive anodized aluminum frame for increased reliability.
- All audio jacks utilize EZ Norm technology for easy normal reconfiguration. A simple twist of the normal cam changes the normal function from full, to half, to no normals.
- Cable tie bar removes weight off the rear terminations.
- Large designation strips for easy patch point identification.



Video Jack Specifications

See page 39 for details

Audio Jack Specifications

See page 10 for details

Part Number: MVEZNP175T

The MVEZN Series combines our popular MVJ midsize video jacks with our latest bantam jack, the EZ Norm. This patchbay has 16 video jacks and 24 dual EZ Norm bantam jacks. Perfect for application where a full video and audio patchbay are unnecessary. The video jacks are rated up to 3.0GHz, and the audio jacks meet 30,000 cycles, both in insertion/withdrawals and with the normal cam.



MBPK Video/Audio Patchbay Series 43

Features and Benefits

- Combines 16 midsize video jacks and 48 TT bantam audio jacks.
- Video jacks are rated from DC to 3.0 GHz.
- All audio jacks are nickel-plated with steel frames and gold-plated cross-bar switching contacts.
- Rugged, attractive anodized aluminum frame for increased reliability.
- Large designation strips for easy patch point identification.
- Audio jacks rated at 30,000 cycles.

Video Jack Specifications

See page 39 for details

Audio Jack Specifications

See page 69 for details

Materials

Frame: Aluminum, black anodized



The MBPK Series combines our popular MVJ midsize video jacks with our standard nickel-plated, steel frame audio jacks. This patchbay combines 16 midsize video jacks with 48 TT bantam audio jacks. Perfect for applications where a full video and audio patchbay are unnecessary. The video jacks are rated up to 3.0GHz, and the audio jacks meet 30,000 cycles. The audio jacks have T, R, S, TN, and RN terminals, and feature gold-plated contacts and flared solder terminals.



DIMENSIONS ARE FOR REFERENCE ONLY

Inch
(mm)

Switchcraft
www.switchcraft.com

5555 North Elston Avenue / Chicago, IL 60630
Phone: 773-792-2700 / Fax: 773-792-2129

PATCHCORDS/MOLDED CABLES

44 Audio and Video Patchcords

Features and Benefits - Audio

- 110 ohm impedance-matched digital patchcords meet AES/EBU interface standards for digital patching
- Available with a variety of plug terminations, plug finishes, cord lengths and cable colors, the patchcords offer design flexibility
- Premium quality cable insures high reliability and greater flexibility



Specifications

Standard plug terminations are single 3-conductor 1/4" and TT® Nickel-plated plugs (standard), brass and gold-plated (optional) Cable jacket material is PVC. Black is standard with other colors available

Features and Benefits - Video

- Designed and built to highest quality standards for efficient video signal transmission
- Cable type is RG59 (75W)
- Rugged nickel-plated handles with knurled area for positive finger grip
- Available in standard size or midsize styles

Specifications

Materials

Housing: Nickel-plated, copper alloy
 Contact Pin: Gold-plated, copper alloy
 Boot: Thermoplastic, in black and colors

A wide variety of audio patchcords and molded cable assemblies are available. Some of the more popular versions are the 18Q and 20Q Series for professional 1/4" patching, the TT* and TTD Series for TT or bantam AES/EBU digital patching. The VP and VMP Series offer exceptional performance for video signal patching.



Ordering Information

Video Patchcords

Part Number	Type	Part Number	Type
VP3**	Standard	VMP2**	Midsize
VP4**	Standard	VMP3**	Midsize
VP5**	Standard	VMP4**	Midsize
VP6**	Standard	VMP5**	Midsize
VP7**	Standard	VMP6**	Midsize
VP8**	Standard	VMP7**	Midsize
VP9**	Standard	VMP8**	Midsize
VP10**	Standard	VMP9**	Midsize
VSPP	Standard	VMP10**	Midsize
VMP1**	Midsize	VMPP	Midsize

When ordering, add the following for cable color: BK-Black, BL-Blue, R-Red, O-Orange, Y-Yellow, GN-Green, P-Purple, GY-Gray

PATCHCORDS/MOLDED CABLES

Audio and Video Patchcords

Ordering Information

Part Number	Type	Plug	Finger	Description
Audio Patchcords				
18QD18	1/4" Mil-Type	Brass		2 foot, black nylon jacket
18QF18	1/4" Mil-Type	Brass		3 foot, black nylon jacket
18QH18	1/4" Mil-Type	Brass		4 foot, black nylon jacket
20QD20N*	1/4" Mil-Type	Nickel		2 foot, nylon jacket
20QF20N*	1/4" Mil-Type	Nickel		3 foot, nylon jacket
20QH20N*	1/4" Mil-Type	Nickel		4 foot, nylon jacket

When ordering, add the following for cable color: 0-Black, 2-Red, 5-Green, 6-Blue

TT122	TT or Bantam	Brass		1 foot, molded gray jacket
TT124	TT or Bantam	Brass		2 foot, molded gray jacket
TT126	TT or Bantam	Brass		3 foot, molded gray jacket
TT127	TT or Bantam	Brass		4 foot, molded gray jacket
TT128	TT or Bantam	Brass		5 foot, molded gray jacket

AES/EBU 110 Ohm Digital Single Plug Patchcords

TT1*	TT or Bantam	Nickel		1 foot, molded
TT2*	TT or Bantam	Nickel		2 foot, molded
TT3*	TT or Bantam	Nickel		3 foot, molded
TT4*	TT or Bantam	Nickel		4 foot, molded
TT5*	TT or Bantam	Nickel		5 foot, molded
TT6*	TT or Bantam	Nickel		6 foot, molded
TT7*	TT or Bantam	Nickel		7 foot, molded
TT8*	TT or Bantam	Nickel		8 foot, molded
TT9*	TT or Bantam	Nickel		9 foot, molded
TT10*	TT or Bantam	Nickel		10 foot, molded

AES/EBU 110 Ohm Digital, or RS422 Dual Plug Patchcords

TTD1*	TT or Bantam	Nickel		1 foot, molded
TTD2*	TT or Bantam	Nickel		2 foot, molded
TTD3*	TT or Bantam	Nickel		3 foot, molded
TTD4*	TT or Bantam	Nickel		4 foot, molded
TTD5*	TT or Bantam	Nickel		5 foot, molded
TTD6*	TT or Bantam	Nickel		6 foot, molded
TTD7*	TT or Bantam	Nickel		7 foot, molded
TTD8*	TT or Bantam	Nickel		8 foot, molded
TTD9*	TT or Bantam	Nickel		8 foot, molded
TTD10*	TT or Bantam	Nickel		10 foot, molded

When ordering, add the following for cable color: BK-Black, BL-Blue, R-Red, O-Orange, Y-Yellow, GN-Green, P-Purple, GY-Gray

Ordering Information

Part No.	Description
Molded MIDI Cables	
MD3	3 foot, 5 pin DIN, molded black
MD6	6 foot, 5 pin DIN, molded black
MD10	10 foot, 5 pin DIN, molded black
MD15	15 foot, 5 pin DIN, molded black

Uses 4 cond., 24 awg, PVC outer jacket, braided shielded cable

1/4" Cables

05AD05	2 foot, mono, male to male
05AK05	6 foot, mono, male to male
05AN05	10 foot, mono, male to male
05AU05	25 foot, mono, male to male
05AN15	10 foot, mono, male to RA male
05AN80	10 foot, mono, male to female
05AU80	25 foot, mono, male to female
10BF10	3 foot, stereo, male to male
10BK10	6 foot, stereo, male to male
10BN10	10 foot, stereo, male to male
15AK15	6 foot, mono, RA male to RA male

RCA

25AF25	3 foot, male to male
25AK25	6 foot, male to male
25AN25	10 foot, male to male
25AK82	6 foot, male to female
30AK30	6 foot, RA male to RA male
30AN30	10 foot, RA male to RA male
30AR30	15 foot, RA male to RA male

1/4" to RCA

05AK25	6 foot, 1/4" male to RCA male
05AN25	10 foot, 1/4" male to RCA male

Uses either single or 2 cond, 22awg, PVC outer jacket, braided shielded cable

DIMENSIONS ARE FOR REFERENCE ONLY $\frac{\text{Inch}}{(\text{mm})}$

CONNECTORS

46 Q-G® Audio Connector Series A, AA, AAA Cord Style Series

Switchcraft offers a wide range of cord style XLR connectors.

The A Series features a dual pressure plate strain relief mechanism to securely fasten the connector to the cable. The A Series is also available with FAS-DISCONNECT detent.

The AA Series features a 1-piece strain relief mechanism that clamps onto the outer jacket of the cable.

The AAA Series features a twist-on handle with a built-in strain relief mechanism and a pre-loaded insert. The new R Series offers the same strain relief system as the AAA Series.

Specifications

Electrical

Contact Resistance: 50 milliohm maximum, per pole

Current Rating @ 125VAC:

3 pole - 15A, 4 pole - 10A,

5 & 6 pole - 7.5A, 7 pole - 5A

Insulation Resistance: 1,000 MW, minimum

Dielectric Withstanding Voltage: 1,000 V (rms)

Capacitance: ≤3pF between pins and ≤6 pF between pins and shell, maximum

Mechanical

Insertion/Withdrawal Forces:

10 lbs. maximum, 8 lbs. nominal/

7 lbs. maximum, 5 lbs. nominal

Materials

Shell: Die-Cast zinc with nickel finish or black chrome

Handle: Die cast with nickel finish or black chrome. Also black thermoplastic handle available

O Ring: TPR (Thermoplastic rubber).

Insert Insulation: Molded thermoplastic

Socket Contacts: Silver plated copper alloy tarnish resistant; bifurcated on 3 and 4 contact types. Gold is available.

Pin Contacts: Silver plated copper alloy.

See Page 56 for Mechanical Drawings



Resists tarnishing, and provides excellent electrical conductivity.

Gold is available.

Latch lock: High strength die cast zinc

Multi-finger cable clamp and rubber

gasket: TPR (Thermoplastic plastic & rubber)

Flex Relief: TPR (Thermoplastic rubber)

Ordering Information

Part Number	Style	Finish	Pins/Contacts	Notes
A*F, A*M	Cord	Nickel	Silver	Standard Cable Clamp
A*FB, A*MB	Cord	Black	Silver	Standard Cable Clamp
A*FBAU, A*MBAU	Cord	Black	Gold	Standard Cable Clamp
A*FL, A*ML	Cord	Nickel	Silver	Standard cable clamp, large flex relief
AA*F, AA*M	Cord	Nickel	Silver	One piece cable clamp
AA*FB, AA*MB	Cord	Black	Silver	One piece cable clamp
AA*FBAU, AA*MBAU	Cord	Black	Gold	One piece cable clamp
AA*FL, AA*ML	Cord	Nickel	Silver	One piece cable clamp, large flex relief
AAA*FZ, AAA*MZ	Cord	Nickel	Silver	Twist-on metal handle
AAA*FBZ, AAA*MBZ	Cord	Black	Silver	Twist-on metal handle
AAA*FBAUZ, AAA*MBAUZ	Cord	Black	Gold	Twist-on metal handle
AAA*FPZ, AAA*MPZ	Cord	Nickel	Silver	Twist-on plastic handle
AAA*FPBZ, AAA*MPBZ	Cord	Black	Silver	Twist-on plastic handle
AAA*FPBAUZ, AAA*MPBAUZ	Cord	Black	Gold	Twist-on plastic handle

* Available 3 - 7 pins or contacts

Switchcraft

CONNECTORS

Q-G® Audio Connector Series B, C, D, E Panel Style Series

47



Switchcraft also offers a wide range of panel mount connectors.

The B Series features a round housing with a threaded collar for mounting. The female version requires a spanner wrench to tighten the connector to the chassis. Both male and female are available with black finish.

The C Series is another round housing panel mount, which has 0.140" mounting holes requiring #5-40 screws to mount.

The D Series, our most popular version, is a rectangle housing panel mount. The standard Rawall finish resists scratching, while the optional satin finish offers a smooth finish for mounting on a brushed finished chassis.

The E Series offers a panel mount with quick release inserts. A small screwdriver is used to remove the inserts, allowing for easy gender changes. The male and female E Series fit into the same panel cut-outs.

The E Series is also available with PC terminals. Contact the factory for details.

Ordering Information

Part Number	Style	Finish	Pins/ Contacts	Notes
B*F, B*M	Panel	Nickel	Silver	Threaded Collar
B*FB, B*MB	Panel	Black	Silver	Threaded Collar
C*F, C*M	Panel	Nickel	Silver	Uses #5-40 mounting screws
C*FB, C*MB	Panel	Black	Silver	Uses #5-40 mounting screws
D*F, D*M	Panel	Nickel	Silver	Uses #5-40 mounting screws
D*FB, D*MB	Panel	Black	Silver	Rectangle housing
D*FBAU, D*MBAU	Panel	Black	Gold	Rectangle housing
D*FS, D*MS	Panel	Nickel	Silver	Rectangle housing, smooth finish
E3FSC, E3MSC	Panel	Nickel	Silver	Male/Female same panel cut-out
E3FSCB, E3MSCB	Panel	Black	Silver	Male/Female same panel cut-out
E3FSCBAU, E3MSCBAU	Panel	Black	Gold	Male/Female same panel cut-out

* Available 3 - 7 pins or contacts

See Page 57 for Mechanical Drawings

CONNECTORS

48

Q-G® Audio Connector Series J, K, P, R, T Wallplate, Gooseneck, Panel & Cord Style Series

The J and K Series are wallplates using the D Series receptacles pre-mounted. Available in single or dual connector versions.

The PD Series is a plastic panel mount series, using 94V-0 rated material. Both male and female mount into the same panel cut-out and are available in solder cup, straight PC, and right angle PC terminals.

Switchcraft also offers gooseneck connectors and cord plugs with on-off switches. The P Series are gooseneck connectors available in male or female, with optional black finishes. The male has external 5/8-27 threads, the female has internal 5/8-27 threads.

The new R Series incorporates the same strain relief system as the AAA Series. The insert can be offset at 45° to accommodate a wide variety of applications.

The T Series is similar to the A Series female cord plug, but offers a DPDT (2-C) locking on-off switch. The slide switch is rated at 500mA, 125V.



Ordering Information

Part Number	Style	Finish	Pins/ Contacts	Notes
J3FS	Wallplate	Nickel	Silver	Single D3F
K3FS	Wallplate	Nickel	Silver	Dual D3F's
P*F, P*M	Gooseneck	Nickel	Silver	Female ext. threads, male int.threads
P*FB, P*MB	Gooseneck	Black	Silver	Female ext. threads, male int.threads
PD3FSC1, PD3MSC1	Panel	Black	Silver	Plastic Housing
PD3FSC1AU, PD3MSC1AU	Panel	Black	Gold	Plastic Housing
R*FZ, R*MZ	Cord	Nickel	Silver	Right Angle
R*FBZ, R*MBZ	Cord	Black	Silver	Right Angle
R*FBAUZ, R*MBAUZ	Cord	Black	Gold	Right Angle
T3F	Cord	Nickel	Silver	On-off switch

* Available 3 - 7 pins or contacts

See Pages 58 and 59 for Mechanical Drawings

Switchcraft

CONNECTORS

Tini-Q-G® Connector Series Tini-Q-G® Cord & Panel Style Series



The Tini-QG Series is a miniature version of the standard QG Series. These “mini-XLR’s” come in a wide variety of configurations. The standard TA Series cord plugs are available in 3-6 pins or contacts. The L versions, with their larger strain reliefs, are available in 3-8 pins or contacts. The TB and TY Series are panel mount connectors. The TB Series is a male connector, featuring a round panel cut-out and 3-8 pins. The TY Series is a female connector, featuring a rectangular housing and 3-5 contacts. The TA and TB Series are available with a black finish. Gold-plated contacts are available on all series. Contact the factory for details.

Materials

Housing: Plugs and Male Receptacles — Copper alloy, nickel-plated;
Female Receptacles — Die-cast zinc, nickel-plated
Black Tini-Q-G® Housing: Copper alloy, black chrome-plated
Pin and Socket Contacts: Copper alloy, silver-plated
Flex Relief: Molded black thermoplastic elastomer
Latch Button: Molded black thermoplastic

Release Lever and Mounting Washer: Steel, nickel-plated
Standoff/Ground Terminal and Cable Clamp: Steel, electroplated
Inserts and Insulating Spacer: Molded, high strength thermoplastic
Latch (Female): Copper alloy, nickel-plated
Mounting Nut: Copper alloy, nickel-plated

Ordering Information

Part Number	Style	Finish	Pins/Contacts	Notes
TA*F, TA*M	Cord	Nickel	Silver	Available in 3 - 6 pins or contacts
TA*FL, TA*ML	Cord	Nickel	Silver	Accommodates large cable, available in 3 - 8 pins or contacts
TA*FB, TA*MB	Cord	Black	Silver	Available in 3 - 6 pins or contacts
TB*M	Panel	Nickel	Silver	Male, round flange, threaded, available in 3 - 8 pins or contacts
TB*MB	Panel	Black	Silver	Male, round flange, threaded, available in 3 - 8 pins or contacts
TY*F	Panel	Nickel	Silver	Female, rectangle flange, available in 3 - 5 pins or contacts

See Page 59 for Mechanical Drawings

Specifications

Electrical

Contact Resistance: .010 ohms maximum after life (and after salt spray)
Current Rating (Carry Only): 5A, 125 VAC (4A, 125 VAC on 5 circuit) based on 30°C maximum
Insulation Resistance: 510,000 megohms minimum @ 500 VDC (initial); 10,000 megohms minimum (after humidity test)
Dielectric Strength: 1,000V (rms)

Mechanical

Life: 5,000 operations minimum
Solderability Standard: Meets EIA RS-186-9E
Mechanical Shock: Meets Mil-Std-202, method 213B
Vibration: Meets Mil-Std-202, method 201A
Wire Size: #22 wire gauge solid; #24 wire gauge stranded

Environmental

Thermal Range: -55°C to +85°C
Humidity: Meets Mil-Std-202, method 106D
Thermal Shock: Meets Mil-Std-202, method 107D
Salt Spray: Meets Mil-Std-202, method 101

CONNECTORS

50 HPC Connector Series HPC Panel Style Series

The HPC Series is a complete line of high power loudspeaker connectors that are completely compatible with the Neutrik® Speakon® 4 pole connector series. Included in the series are round and rectangular panel mounts, straight cord plugs, right angle cord plugs, and in-line cord plug, plus a barrel adapter.

The HPC panel mounts come with two different flange depths, either 0.100" or 0.200" depths. The 0.200" depth allows for easy rear mounting of the connector and maintains proper mating with the cord plug. Also, the panel mounts have two different Faston® terminal sizes, 0.187" and 0.250" wide. Both are rated at 50A, per UL 1977. The PC mount versions have either straight, right angle, or right angle with a mounting post. They are rated at 30A per UL 1977. The right angle PC mount version with the post allows for snap-in placement onto the PC board during wave soldering.

The HPC cord plugs are offered in straight, right angle, and an in-line version. All have 0.250" Faston® terminals, rated at 50A per UL 1977, which makes it easy to swap out plugs. The unique feature of the cord plugs is their "push to lock" design. They do not require a 1/4 turn to engage the contacts – simply push the connector in like an XLR. This feature eliminates the need to remember to turn the connector to make contact with the contacts. To disengage, simply push the latch lever forward and pull the connector out. The straight cord plug uses a twist on handle, while the in-line and right angle cord plugs use a snap-in handle. The in-line connector mates with both straight and right angle cord plugs.

For those who find it more convenient, we also offer a barrel adapter which mates with either straight or right angle cord plugs.



Ordering Information

Part Number	Style	Notes
HPCP41F	Panel	Rectangle, 0.100" flange depth, 0.250" faston terms
HPCP42F	Panel	Rectangle, 0.200" flange depth, 0.250" faston terms
HPCP41F1	Panel	Rectangle, 0.100" flange depth, 0.187" faston terms
HPCP42F1	Panel	Rectangle, 0.200" flange depth, 0.187" faston terms
HPCP410PC	Panel	Rectangle, 0.100" flange depth, straight PC terms
HPCP420PC	Panel	Rectangle, 0.200" flange depth, straight PC terms
HPCP410RA	Panel	Rectangle, 0.100" flange depth, right angle PC terms
HPCP420RA	Panel	Rectangle, 0.200" flange depth, right angle PC terms
HPCPR41F	Panel	Round, 0.100" flange depth, 0.250" faston terms
HPCPR42F	Panel	Round, 0.200" flange depth, 0.250" faston terms
HPCPR41F1	Panel	Round, 0.100" flange depth, 0.187" faston terms
HPCPR42F1	Panel	Round, 0.200" flange depth, 0.187" faston terms
HPCPR410PC	Panel	Round, 0.100" flange depth, straight PC terms
HPCPR420PC	Panel	Round, 0.200" flange depth, straight PC terms

See Pages 61 and 62 for Mechanical Drawings

CONNECTORS

HPC Connector Series HPC Cord, & Adapter Style Series



Specifications

Mechanical (Panel and Cord Mounts)

Shock: Per Mil-Std 202,
Method 213B, Cond. K
Vibration: Mil-Std 202,
Method 201A
Life: 1,000 rotational cycles
Cable Range (cord mount):
10AWG, 0.560" cable OD
maximum

Electrical (Panel and Cord Mounts)

Voltage Rating: 1,500 AC RMS,
per Mil-Std 202, Method 301
Current Rating (Faston® terminals): 50A RMS w/10AWG
wire, normal ambient, per
UL 1977
Current Rating (PC terminals):
30A per UL 1977
Contact Resistance: 1mΩ, 1.5mΩ
after 1,000 insertion/withdrawals
Insulation Resistance: > 2T Ω

Environmental (Panel and Cord Mounts)

Salt Spray: Mil-Std 202, Method
101D, Cond. B
Thermal Shock: Mil-Std 202,
Method 107G
Temperature Limits:
-55°C to +85°C
Moisture Resistance: Mil-Std.
202, Method 106E
Life @ Ambient Temperature:
Mil-Std 202, Method 108A
Touchproof: IEC 65 and 1010-1
IP Rating: IEC 529, IP 25

Materials (Panel and Cord Mounts)

Housings:
Thermoplastic UL 94V-0 rated
Seal Rings: Thermoplastic rubber
Contacts: Silver-plated over
copper alloy

Ordering Information

Part Number	Style	Notes
HPCC4F	Cord	Straight with 0.250" faston terms
HPC14F	Cord	Inline with 0.250" faston terms
HPCC4RAF	Cord	Right angle with 0.250" faston terms

See Page 62 for Mechanical Drawings

CONNECTORS

52 EH Series Receptacles

The EH Series consist of different styles of popular connectors in our E Series housing. This allows the end user to punch one single hole size and populate wall plates, gang assemblies with different types of connectors. Connector styles include BNC feed-throughs, RCA feed-throughs, USB feed-throughs, IEEE 1394 Firewire feed-throughs, BNC to solder cup, and RCA to BNC.

Features

- Utilizes same panel cut-out as E Series QG connectors
- Rugged metal shells
- Available with a wide variety of popular feed-through connectors



Ordering Information

Part Number	Description
EHBNC2	BNC to BNC
EHBNCSC	BNC to solder cup
EHRCA2	RCA to RCA
EHRCABNC	RCA to BNC
EHUSB2	USB to USB
EH13942	IEEE1394 to IEEE1394
EHCAT62	Cat6 to Cat6

Note: For black finish add 'B' suffix
See Page 55 for Mechanical Drawings

Switel

CONNECTORS

MIDI and 2500 Series 53

The 5-pin DIN connector has been adopted by the audio industry as the standard MIDI (Musical Instrument Digital Interface) connector. Switchcraft offers a wide variety of DIN and mini-DIN connectors, however, only the 5-pin DIN versions are shown in this catalog. The more popular versions used in the audio industry include straight metal, straight plastic, and right angle cord plugs, as well as metal chassis and plastic right angle PC mount versions.

The 2500 Series microphone connectors are still used in many retro-style microphones. Cable mount versions can accommodate cable OD's up to 0.281".

Specifications

Materials

- Shell: Die-cast zinc alloy, nickel plated
- Receptacle Mounting Flange: Steel
- Receptacle Body: Plastic
- Insert Material: Plastic
- Socket Contacts: Tin-plated
- Pin Contacts: Tin-plated
- Switching Contacts: Silver-plated
- Cable Relief Bushing: Soft plastic



Ordering Information

Part Number	Style	Notes
05BL5M	Cord	Male, straight, metal handle
05GM5M	Cord	Male, straight, plastic handle
05DL5M	Cord	Male, right angle, metal handle
57GB5F	Panel	Female
57PC5F	Panel	Female, right angle, PC mount
57PC5FS	Panel	Female, right angle, PC mount, shielded
2501F	Cord	Female, single contact, locking collar
2501M	Cord	Male, single contact, ext. threads
2501MP	Panel	Male, single contact, ext. threads

See Page 60 for Mechanical Drawings



5555 North Elston Avenue / Chicago, IL 60630
Phone: 773-792-2700 / Fax: 773-792-2129

CONNECTORS

54

HP75BNC Series True 75 Ohm BNC Series

The HP75BNC Series is a true 75 Ohm impedance BNC connector series. All connectors meet stringent guidelines for top performance. The HP75BNC Series is available in a wide variety of cable types. All use standard crimping tools.

Features and Benefits

- True 75 Ohm impedance
- Rugged nickel-plated, machined housings
- Gold-plated center pins enhance performance

Specifications

Electrical

Contact Resistance: 75 Ohms
Voltage Rating: 500 Volts RMS
Return Loss: Less than -25 db at 3 GHz
Insulation Resistance:
5000 Megohms minimum

Mechanical

Lifecycles: 500 minimum
Center Contact Retention:
6 lbs. minimum
Coupling Mechanism:
100 lbs. minimum
Force to Engage:
2.5 lbs. maximum

Environmental

Thermal Range: -65°C to 165°C
Moisture Resistance: Mil Std 202
Corrosion: Mil Std 202
Flammability: UL 94-V0
Vibration: Mil Std 202
Solvent Resistance: Mil Std 202

Finish

Body/Bayonet: Nickel-plated, copper alloy
Center Conductor: 50 mi gold-plated copper alloy



Ordering Information

Part Number	Crimp Info	Cable Type
HP75BNC1	Pin .041 Hex Ferrule .255	Belden 8241, 8279, 82241 Gepco VJ59U Comm/Scope 5563
HP75BNC2	Pin .041 Hex Ferrule .324 Hex	Belden 8281, 8281B, 9141, 88281, 9231, 8141, 9118, 9248 Gepco VP618PE, VP618PVC, VP6000 Comm/Scope 7501, 7506
HP75BNC7	Pin .041 Hex Ferrule .278 Hex	Belden 1694A, 1695A, 87120, 89120, 9066, 9114, 9659 Gepco VSD2001, VSD2001TS Comm/Scope 5729 ,5765, 2227K, 2227V, 2229V, 2275V, 2276V, 2279V
HP75BNC9	Pin .041 Hex Ferrule .255 Hex	Belden 1505A, 1506A, 8212, 8241F, 9167, 9259, Gepco VPM2000, VPM2000TS, VPM2000TK Comm/Scope 2000, 5553, 5565, 5572
HP75BNC12	Pin .041 Hex Ferrule .178 Hex	Belden 1855A, 1865A Gepco VDM230, VDM250, RGB230/250 Series Comm/Scope 7537, 7538

See Next Page for
Mechanical Drawings

Switel

CONNECTORS

Connector Dimension Drawings True 75 Ohm BNC Series, EH Series

HP75BNC Series

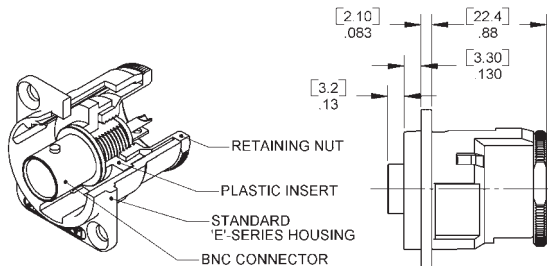

DIMENSIONS ARE FOR REFERENCE ONLY

Inch
(mm)

CONNECTORS

Connector Dimension Drawings Q-G® Audio - A, AA, AAA Series

A*F



A*M

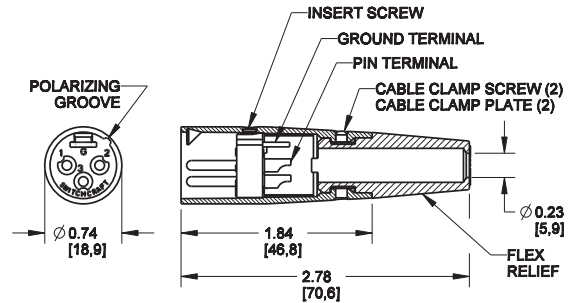

AA*F



AA*M

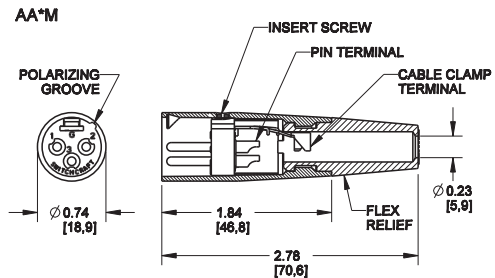

AAA*FZ



AAA*MZ



CONNECTORS

Connector Dimension Drawings Q-G® Audio - B, C, D, E Series

B*F



B*M



C*F



C*M



D*F



D*M



E3FSC and E3MSC



DIMENSIONS ARE FOR REFERENCE ONLY

Inch
(mm)

CONNECTORS

Connector Dimension Drawings Q-G® Audio - J, K, P, R Series

J3FS



K3FS



PD3FSC1AU



PD3MSC1AU



R*MZ



R*FZ



CONNECTORS

Connector Dimension Drawings Q-G® Audio - T Series

T3F



TA*M



TA*F



TB*M



TY*F

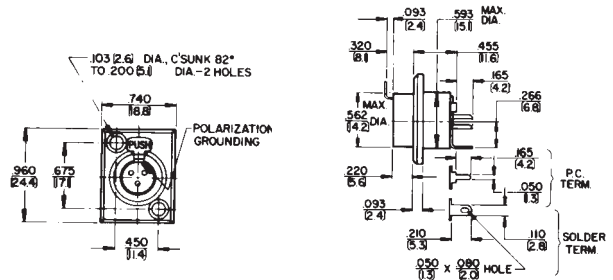

DIMENSIONS ARE FOR REFERENCE ONLY Inch
(mm)

CONNECTORS

60

Connector Dimension Drawings MIDI, Q-G® Audio - P Series

05BL5M



05GM5M



57GB5F



57PC5F



P*F



P*M

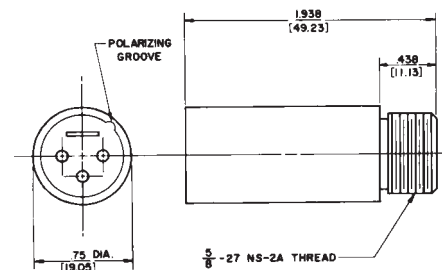

Switche

CONNECTORS

Connector Dimension Drawings HPC Panel Style Series

HPC



FOR ALL TERMINALS SHOWN,
ROUND COUNTERPARTS EXIST

[F] TERMINALS



[F1] TERMINALS



[PC] TERMINALS



STRAIGHT 'PC' TERMINALS
COMPONENT SIDE



[RA] + [RAP] TERMINALS

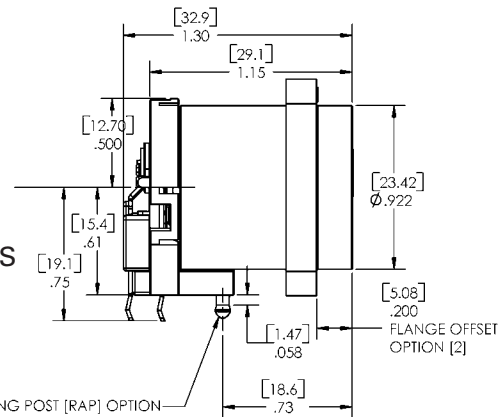

MOUNTING POST [RAP] OPTION

DIMENSIONS ARE FOR REFERENCE ONLY

Inch
(mm)

CONNECTORS

62 Connector Dimension Drawings HPC Panel Style Series

HPC

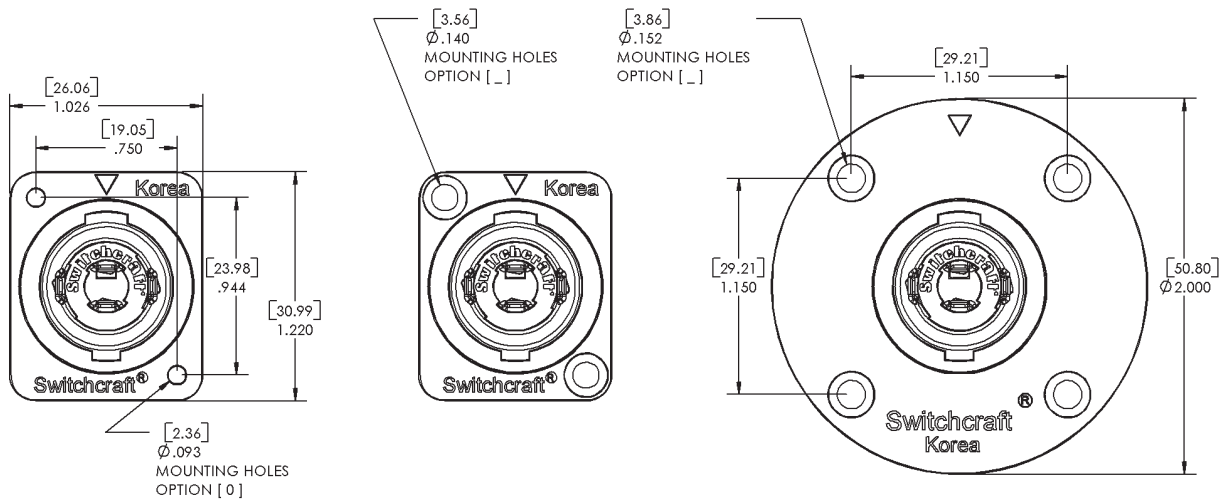
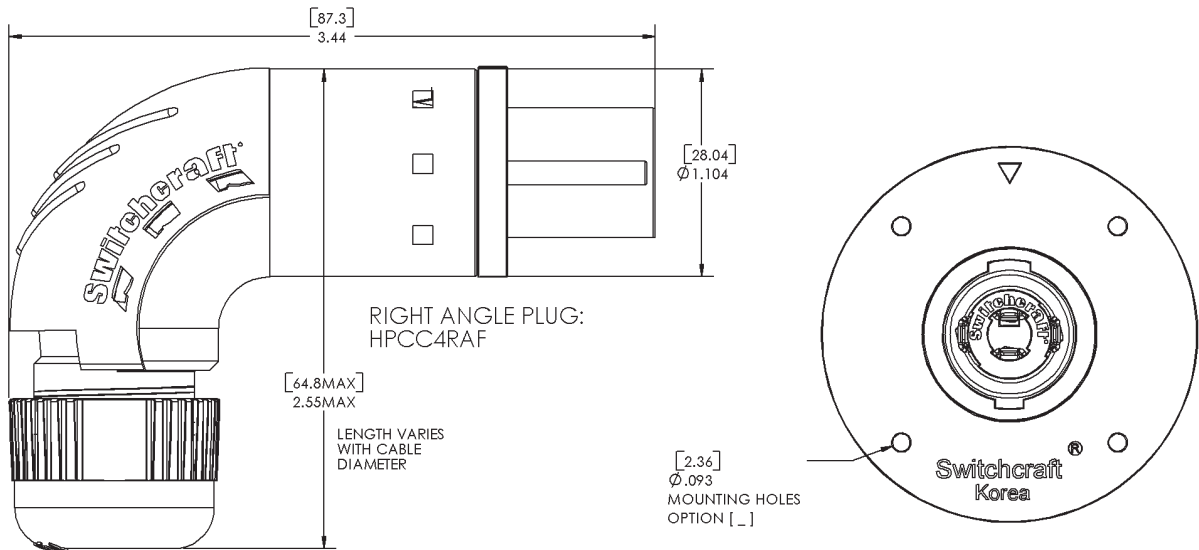

AUDIO ADAPTERS

XLR to XLR, RCA, 1/4," TQ-G Adapter Series

A wide variety of audio adapters are available from Switchcraft. Ranges include XLR to XLR, XLR to RCA, XLR to 1/4", along with a multitude of specialty adapters. Our DMX adapters allow users to adapt from 5 pin DMX controls to the more prevalent 3 pin XLR.

Ordering Information

Part Number	Description
XLR to XLR	
389	3 Pin female to 3 pin female
390	3 Pin male to 3 pin male
S3FM	3 Pin male to 3 pin female
S3F5M	3 Pin female to 5 pin male
S5F3M	5 Pin female to 3 pin male
XLR to RCA	
321	3 Pin female XLR to male RCA
322	3 Pin female XLR to female RCA
323	3 Pin male XLR to male RCA
324	3 Pin male XLR to female RCA
XLR to 1/4"	
383A	3 Pin female XLR to female 1/4", 3 cond.
384A	3 Pin male XLR to female 1/4", 3 cond.
386A	3 Pin female XLR to male 1/4", 3 cond.
387A	3 Pin male XLR to male 1/4", 3 cond.
XLR to TQ-G	
TA01	3 Pin XLR female to 3 pin TQG female
TA02	4 Pin XLR female to 4 pin TQG female
TA04	3 Pin XLR male to 3 pin TQG female
TA05	4 Pin XLR male to 4 pin TQG female



DIMENSIONS ARE FOR REFERENCE ONLY

$\frac{\text{Inch}}{\text{(mm)}}$

Switchcraft
www.switchcraft.com

5555 North Elston Avenue / Chicago, IL 60630
Phone: 773-792-2700 / Fax: 773-792-2129



AUDIO ADAPTERS

64 1/4" to 1/4", RCA; RCA to RCA; & Miscellaneous Adapter Series



Ordering Information

Part Number	Description
1/4" to 1/4"	
361A	Mono female to female
362A	Stereo female to female
363	Mono male to male
340	2 Mono jacks parallel to mono plug
352A	Stereo jack to mono plug
1/4" to RCA	
330P	2 RCA jacks to mono plug, 4" cable
336A	Female 1/4" to male RCA
345A	Female RCA to male 1/4"
RCA to RCA	
330F1	2 Female RCA parallel to 1 male RCA
330F2	1 Male and 1 female parallel to 1 male
349A	Female to female
Miscellaneous	
332A	Old MC1M type to 1/4" female
365	Tini-Jax (.141") to RCA male
370A	Female RCA to Tini-Plug (.141")
374	1/4" female to Tini-Plug (.141")
376	Tini-Jax (.141") to Micro-Plug (.097")
377	Micro-Jax (.097") to Tini-Plug (.141")
44	Female 2500 Series to 1/4" plug

JACKS & PLUGS

Jack Series

65

Littel Phone, Hi-D, Right Angle PC Mount 1/4", 1/4" Extension Jack Series

Switchcraft offers an extensive variety of 1/4" commercial jacks. Littel phone jacks offer open frame designs, Hi-D jacks offer an enclosed, 94V-0 rated thermoplastic housing, our RA jacks are designed for right angle PC board layouts, and our Extension jacks allow the end user to extend cable lengths. All offer a wide range of options to fit a multitude of needs. For mating plugs, look to page 83 for all of the various options.

Specifications

Mechanical

Life: 10,000 insertion/withdrawal cycles, minimum

Electrical

Contact Resistance: .030 ohms maximum (initial), .050 ohms maximum (after humidity, durability exposure) Per Mil-Std-202E

Insulation Resistance: 10,000 MW minimum (initial), 1,000 MW minimum (after humidity)

Dielectric Withstanding Voltage: 500V, 60 Hz (rms) AC

Contact Rating: 1A, 25 VDC

Environmental

Thermal Range: -55°C to +85°C (non-operating); -20°C to +65°C (operating)

Thermal Shock: Per Mil-Std-202, method 107

Humidity: Per Mil-Std-202, method 106

Salt Spray: Per Mil-Std 202, method 101

Materials

Mounting Bushing: Copper alloy, nickel-plated

(RN & RA Series: Thermoplastic)

Insulation: Rigid plastic

Springs: Special copper alloy.

Integral contacts are standard in the isolated switching circuits

Sleeve Terminal: Copper alloy

Hardware: Supplied with one Number P10001 copper alloy nickel-plated hex nut, and one Number S1022 steel nickel-plated washer



See next page for ordering information

JACKS & PLUGS

66 Jack Series

Ordering Information

Part No.	Conductors	Typical Description	Mating Plug	Notes
Littel Phone Jacks				
11	2	single open	280	
12A	2	single closed	280	
12B	3	double open	297	
14B	3	double closed	297	
Hi-D Jacks				
111	2	single open	280	
112B	3	double open	297	
113BPC1M	3	tip closed, ring open (common to sleeve)	297 or 482NC	PC terms, accepts Littel and Mil-type plugs
114B	3	double closed	297	
114BPC	3	double closed	297	PC terms
114BPCS	3	double closed	297	Springlock PC terms
114BPC1M	3	double closed	297 or 482NC	PC terms, accepts Littel and Mil-type plugs, metric thread
Z15J	2	single open	187B	15A rated
Right Angle PC Mount 1/4" Jacks				
RA49B11	2	single open	280	
RN112APC	2	single closed	280	
RA49C14B	3	double closed	297	
1/4" Extension Jacks				
80	2	single open	280	Screw terms, black handle
88	2	single open	280	Solder terms, black handle
120	2	single open	280	Screw terms, shielded handle
121	2	single open	280	Solder terms, shielded handle
131	3	double open	297	Solder terms, shielded handle
133	3	double open	298	Solder terms, shielded handle, locking
830	3	double open	297	Screw terms, black handle
128	2	single open	280	Solder terms, shielded handle
1238	3	double open	297	Solder terms, shielded handle

See Pages 72–74 for Mechanical Drawings

Switel

JACKS & PLUGS

Jack Series

67

Thick Panel/Guitar, Locking 1/4", Tini, Tini-Extension, Micro, 3.5mm

The TP or Thick Panel jacks are typically used in applications such as loud-speaker enclosures and solid-body guitars. Only premium materials are used in the manufacture of these jacks. Locking 1/4" jacks allow the end user to lock the mating plug, providing positive detent to the connection. Also offered is a wide range of 1/8" jacks and true 3.5mm jacks.

Specifications - Thick Panel Series & Locking Jacks

Electrical

Insulation Resistance: 2 x 10⁶ MW
at 500 VDC per Mil-Std-202,
method 302 (initial)
Dielectric Withstanding Voltage:
1,000 VAC (ms)
Life: 10,000 cycles minimum

Environmental

Thermal Range: -55°C to +85°C
(non operating); -20°C to +65°C
(operating)
Thermal Shock: Per Mil-Std-202,
method 107
Humidity: Per Mil-Std-202, method
106
Salt Spray: Per Mil-Std-202, method
101

Materials

Shell - Locking Jacks: Die-cast
zinc, with satin nickel-plating;
Black chrome over nickel-plating
on special order
Insert and Latch: Thermoplastic,
UL94V-0
Latch Release: Nickel-plated
die-cast zinc
Contact Springs: Tin-plated
copper alloy
Mounting Bushing - Thick Panel
Jacks: Nickel-plated copper alloy
with knurled flange
Insulating Spacer: Rigid plastic

(continued on next page)



Switchcraft
www.switchcraft.com

5555 North Elston Avenue / Chicago, IL 60630
Phone: 773-792-2700 / Fax: 773-792-2129

JACKS & PLUGS

68 Jack Series

(continued from previous page)

Insulator/Spring Mount:

Thermo-plastic

Springs: Copper alloy

Terminals: Tip: Copper alloy; Ring:
(Number 152B only) Copper

alloy; Sleeve: Steel, tin-plated

Hardware - Thick Panel Jacks:

Supplied with one, Number

P10531 nickel-plated copper

alloy hex nut; and one, Number

P1476 nickel-plated copper

alloy flat washer

Specifications - 35RAPC Series

Electrical

Contact Resistance: 20 milliohms
maximum

Insulation Resistance: 100

milliohms minimum at 250 VDC

Dielectric Withstanding Voltage:
250 VAC

Life: 5,000 cycles, minimum

Insertion Force: 0.88 pounds -
3.5 pounds

Withdrawal Force: 0.88 pounds -
2.64 pounds

Materials

Coil Spring: Steel Wire

Bushing: Nickel-plated copper alloy

Terminal: Silver-plated copper alloy

Tip Spring: Silver-plated copper alloy

Shunt Terminal: Plated copper alloy

Cover: Thermoplastic, transparent
UL 94V-2

Body: Thermoplastic, UL 94V-1
black color

Specifications - 35PM Series & Tini Jack Series

Electrical

Contact Resistance: .075 ohms
maximum

Insulation Resistance: 5,000 MW
minimum

Dielectric Withstanding Voltage:
250 VAC maximum

Life: 5,000 insertion/withdrawal
cycles, minimum

Contact Rating: .25A, 48 VDC

Materials

Mounting Bushing: Nickel-plated
copper alloy

Insulating Spacers: Rigid plastic

Springs: Copper alloy

Sleeve Terminal: Tin-plated
copper alloy

Hardware: Supplied with one,

Number P11501 nickel-plated
brass locknut; and one, Number
S17901 nickel-plated steel
flat washer

Ordering Information

Part No.	Conductors	Description	Typical Mating Plug	Notes
Thick Panel/Guitar Jacks (1/4")				
151	2	single open	280	Nickel finish
152	3	double open	297	Brass finish
152B	3	double open	297	Nickel finish
153	2	single open	280	Gold-plated springs, electro-polish brass finish, 9/16-12 UNC wood thread
154	3	double open	297	Gold-plated, no cable clamp
155	3	double open	297	Black satin chrome finish, no cable clamp
Locking 1/4" Jacks				
E111L	2	single open	280	
E112BL	3	double open	297	
Tini-Jacks (.141")				
41	2	single open	750	
42A	2	single closed	750	
142A	2	single closed	750	
PC142A	2	single closed	750	PC terms
Tini-Extension Jacks (.141")				
125	2	single open	750	
3.5mm Jacks				
35RAPC2AV	2	single closed		Threaded bushing, PC terms
35RAPC2BH3	3	double open	35HDNN	Threaded bushing, PC terms
35RAPC3BH3	3	tip closed, ring open	35HDNN	Threaded bushing, PC terms
35RAPC4BH3	3	double closed	35HDNN	Threaded bushing, PC terms
35RAPC7J	3	top jack dual open	35HDNN	Dual vertical jack bottom jack dual closed
35RAPC7JS	3	top jack dual open	35HDNN	Dual vertical jack, shielded bottom jack dual closed
35PM1	2	single open	750	
35PM2A	2	single closed	750	

See Pages 75-79 for Mechanical Drawings

Switel

JACKS & PLUGS

Jack Series

Phono, Phono Extension, TT or Bantam, MT 1/4" Jack Series

Phono jacks, more commonly called RCA jacks offer low cost, two conductor connections. TT or bantam jacks are the same type used in our audio patchbays. Typically used in high end studio applications. MT or 1/4" jacks are just a bigger version of the TT jacks. Same high quality, just in a larger package.

Specifications - Phono Jacks

Materials

Frame and Shell: Steel, plated
 Center Terminal: Plated copper alloy (3517PC); Plated copper alloy (3514PC)
 Insulator: Thermoplastic (3514PC) Ceramic and glass filled thermoplastic (3517PC)

For 3515PC Only:

Contact and Saddle: Spring type copper alloy, copper alloy pre-tinned
 Shell: Steel or copper alloy, plated
 Insulator Bushing: Ceramic
 Insulator Spacer: Glass-filled thermoplastic

Specifications - TT and MT Jacks

Mechanical

Life: Commercial – 30,000 insertion/withdrawal cycles, minimum; Military – 30,000 insertion/withdrawal cycles, minimum
 Mechanical Shock: Military – Per Mil-Std-202, method 213, Test Condition H (75g)
 Vibration: Military – Per Mil-Std-202, method 213, (10-55 Hz)

Electrical

Contact Resistance: Commercial – .030 ohms maximum (initial), .050 ohms maximum (after humidity, durability, exposure); Military – .010 ohms maximum (initial), .020 ohms maximum (after life), .10 ohms maximum (after salt spray)
 Insulation Resistance: Commercial – 10,000 MΩ minimum (initial), 1,000 MΩ minimum (after humidity); Military – 10,000 MΩ minimum (initial), 1,000 MΩ minimum (after humidity, durability exposure)
 Dielectric Withstanding Voltage: 500V, 60 Hz (rms) AC

(continued on next page)



JACKS & PLUGS

70 Jack Series

(continued from previous page)

Environmental

Thermal Range: Commercial –
55°C to +85°C (non-operating), -
20°C to +65°C (operating);
Military –
-55°C to +85°C (non operating), -
40°C to +65°C
(operating)
Thermal Shocks: Commercial –
Per Mil-Std-202, method 107;
Military – Per Mil-Std-202,
method 107
Humidity: Commercial –

Per Mil-Std-202, method 106;
Military — 0% to 95% operating
and non-operating
Salt Spray: Commercial –
Per Mil-Std-202, method 101;
Military – Per Mil-Std-202,
method 101 (48 hours)
Moisture Resistance: Military –
Per Mil-Std-202, method 106
(240 hours)

Materials

Frame: Steel, nickel plated
Springs: Copper alloy
Contacts: Welded, crossbar, gold
plated

Ordering Information

Part No.	Conductors	Typical Description	Mating Plug	Notes
Phono Jacks				
3501FP	2	single open	3502A	Front mounting
3501FR	2	single open	3502A	Rear mounting
3514PC	2	single open	3502A	Right angle, PC mount
3517PC	2	single open	3502A	Right angle, PC mount
BPJR**	2	single open	3502A	Rear mounting, colored insulators
BPJR**AU	2	single open	3502A	Same as above, with gold-plating
BPJF**	2	single open	3502A	Front mounting, colored insulators
BPJF**AU	2	single open	3502A	Same as above, with gold-plating
BPJJ**	2	single open	3502A	Feed through mount
BPJJ**AU	2	single open	3502A	Same as above, with gold-plating
Phone Extension Jacks				
3503	2	single open	3502A	
TT or Bantam Jacks				
TT34B	3	double closed	TT253NC	
TT34BNY	3	double closed	TT253NC	Nickel-plated frame, fanned terminals
WTT34B	3	double closed	TT253NC	Wire-wrap terminals
MT 1/4" Jacks				
MT334B	3	double closed	482NC	
WMT334B	3	double closed	482NC	Wire-wrap terminals
YMT334BN	3	double closed	482NC	Nickel-plated frame, fanned terminals

** To designate color of insulator, use: 01- Black, 02 - Red, 03 - White, 04 - Yellow, 05 - Blue, 06 - Green

See Pages 80-82 for Mechanical Drawings

Switel

JACKS & PLUGS

Power/Jacks Plugs Series 700, S700, 800 Cord & Panel Style Series

71

Low power AC to DC power jacks and plugs are used throughout the audio industry, to power a wide variety of products. Switchcraft offers both cord plug and panel mount versions, including locking and non-locking versions.

Specifications - Plugs

Electrical:

Current (Carry): 5 amps

Materials

Plug Sleeve and Pin: Nickel-plated copper alloy
 Lock Ring: Nickel-plated copper alloy
 Lock Ring Thread Size: 5/16" - 32 UNEF 2B
 Finger Insulator: Molded plastic
 Insulating Washers: Rigid plastic
 Sleeve Terminal: Copper alloy, electro-tinned
 Handle: Molded plastic
 Handle Thread Size: 5/16" - 24 UNF 2B

Specifications - Jacks

Mechanical

Life: 10,000 insertion/withdrawal cycles minimum
 Insertion/Withdrawal Forces:
 3 pound insertion (maximum),
 4 ounce minimum withdrawal

Electrical

Contact Resistance: .01 ohms maximum (initial), .02 ohms maximum (after humidity, durability exposure), .1 ohms maximum (after salt spray)
 Insulation Resistance: 10,000 MW minimum (initial), 1,000 MW minimum (after humidity, durability exposure)
 Dielectric Withstanding Voltage: 500 VAC maximum
 Contact Rating: 5A, 12 VDC resistive



Materials

Housing: Molded plastic
 Mounting Bushing and Hex Nut: Plated copper alloy
 Pin, Spring and Terminals: Plated copper alloy
 Insulators: Rigid plastic
 Hardware: Supplied with one

Number P2439 nickel-plated brass hex nut, and one Number P2441 nickel-plated steel flat washer

Ordering Information

Part Number	Style	Notes
712A	Panel	0.100" center pin
722A	Panel	0.080" center pin
732A	Panel	0.050" center pin
760	Cord	0.100" center hole, black handle
765	Cord	0.100" center hole, red handle
S760	Cord	0.080" center hole, black handle
S765	Cord	0.080" center hole, red handle
860	Cord	0.050" center hole, black handle
865	Cord	0.050" center hole, red handle
760K	Cord	0.100" center hole, black handle, locking
S760K	Cord	0.080" center hole, black handle, locking

See Next Page for Mechanical Drawings

JACKS & PLUGS

72 Jack Series Dimension Drawings Littel Phone, Hi-D, 1/4" Extension, 700 Panel Jack Series

11, 12A, 12B, 14B



11 Series



12A Series



12B Series



14B Series

712A



Z15J



80



Switel

JACKS & PLUGS

Jack Series Dimension Drawings Littel Phone, Hi-D, 1/4" Extension Jack Series

Solder Lug Terminals for Hi-D Jax - 111, 112B, 114B



Spring Lock PC Terminals for Hi-D Jax - 114BPCS



PC Terminals for Hi-D Jax - 113BPC1M, 114BPC1M



DIMENSIONS ARE FOR REFERENCE ONLY $\frac{\text{Inch}}{(\text{mm})}$

JACKS & PLUGS

74

Jack Series Dimension Drawings Right Angle PC Mount 1/4" Jack Series

RA49B11

RA49C14B



RN112APC



Switel

JACKS & PLUGS

Jack Series Dimension Drawings Thick Panel/Guitar, Locking 1/4", Tini, Tini Extension Jack Series

151, 153



E111L, E112BL



41, 42A



125



DIMENSIONS ARE FOR REFERENCE ONLY

Inch
(mm)

JACKS & PLUGS

76 Jack Series Dimension Drawings Micro, 3.5mm Jack Series

142, PC142A

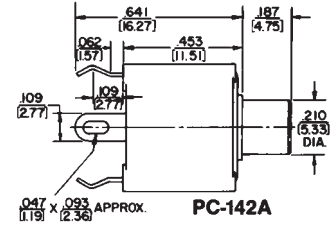
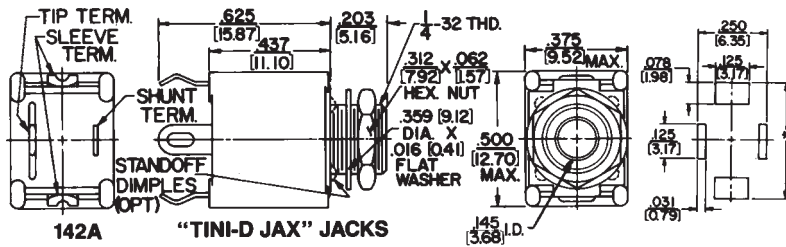

- * .406 FOR .062 THK. BOARD (10.31) (1.57)
- * .422 FOR .078 THK. BOARD (10.72) (1.98)
- * .437 FOR .093 THK. BOARD (11.10) (2.36)

RECOMMENDED PC BOARD LAYOUTS

35RAPC2AV

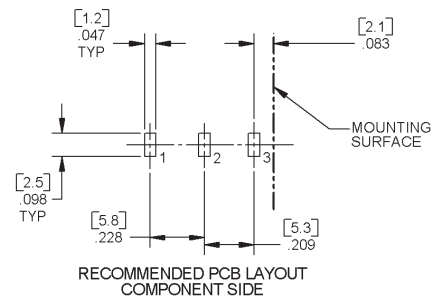
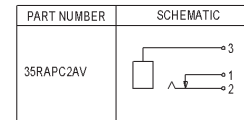
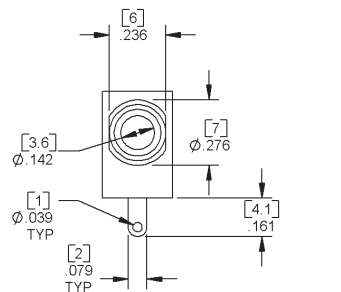
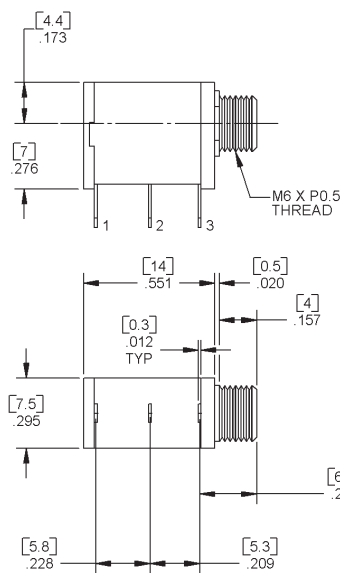

JACKS & PLUGS

Jack Series Dimension Drawings 3.5mm Jack Series

35RAPC2BH3, 35RAPC3BH3, 35RAPC4BH3



DIMENSIONS ARE FOR REFERENCE ONLY

Inch
(mm)

JACKS & PLUGS

78

Jack Series Dimension Drawings 3.5mm Jack Series

35RAPC7J, 35RAPC7JS

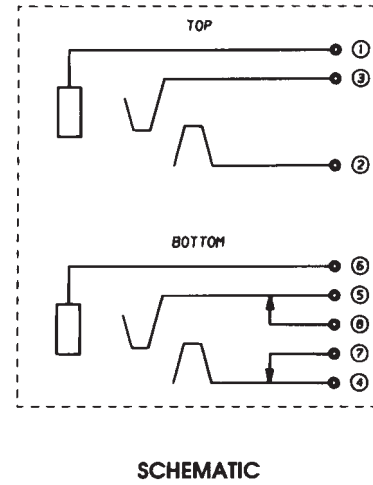
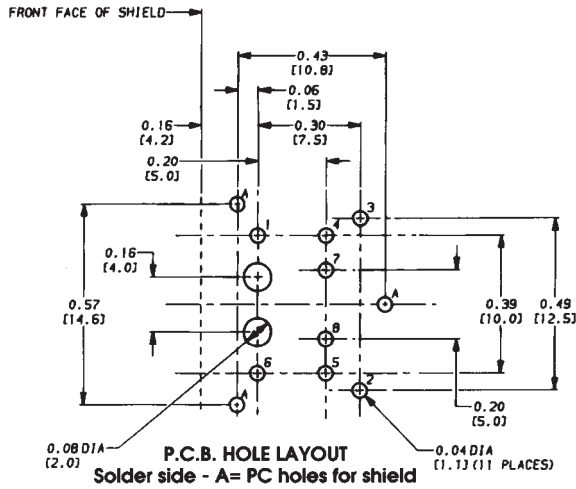
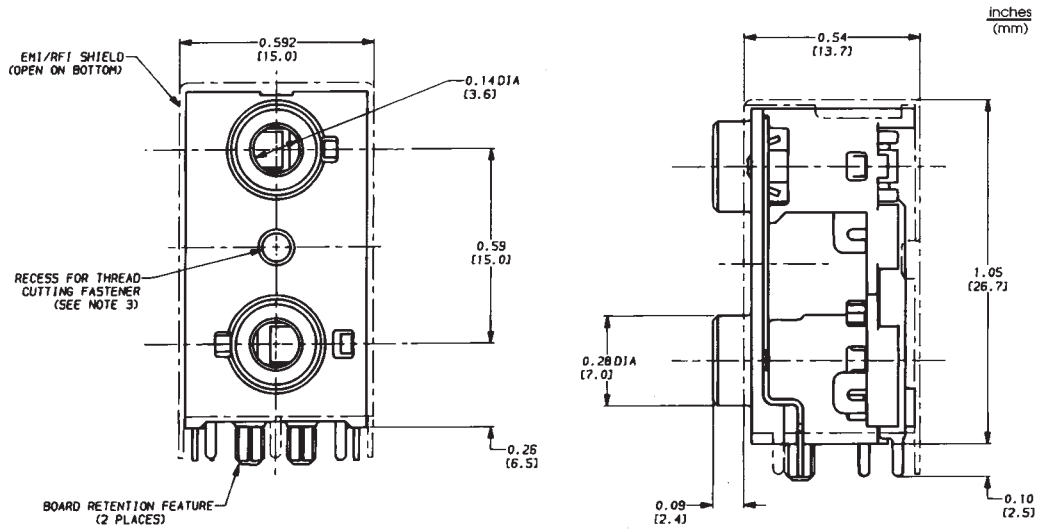

JACKS & PLUGS

Jack Series Dimension Drawings 3.5mm Jack Series

35PM1



35PM2A



DIMENSIONS ARE FOR REFERENCE ONLY $\frac{\text{Inch}}{\text{(mm)}}$

JACKS & PLUGS

Jack Series Dimension Drawings Phono and Phono Extension Jack Series

3501FP



BPJJ Series



3501FR



BPJF Series



3503 Extension



BPJR Series



3514PC, 3517PC



JACKS & PLUGS

Jack Series Dimension Drawings TT or Bantam Jack Series

TT34B, TT34BN, WTT34B



DIMENSIONS ARE FOR REFERENCE ONLY

Inch
(mm)

JACKS & PLUGS

82

Jack Series Dimension Drawings MT 1/4" Jack Series

MT334B, WMT334B, YMT334BN



Switel

JACKS & PLUGS

Plug Series **83**

Littel 1/4", Right Angle 1/4", Silent, Super Heavy Duty Plug Series

Switchcraft Littel Plugs all feature one-piece tip rods for added strength and durability. All are offered in a wide variety of configurations, including straight, right angle, shielded, screw or solder terminals. The Heavy Duty Speaker plugs have larger cable clamps and are rated at 15A. The Silent plugs have a unique circuit-closing device which stops hums, pops, and squeals when the plug is removed or inserted from the jack. Miti plugs feature heavy duty brass construction, rugged cable clamps, and spring flex reliefs. All plugs meet EIA standards for tip configuration, which ensures you they mate properly with the jack.



Specifications

Electrical

- Contact Resistance (typical Depends on Mating Jack):
< 0.020 ohms
- Dielectric Withstand Voltage: 500 VAC (minimum)
- Insulation Resistance @ 500 VDC: 2,000 megohms (minimum)
- Insulation Resistance (after Mil-Std-202 Salt Spray): 1,000 megohms (minimum)
- Working Voltage: 250 VAC, 140 VDC
- Insert/Withdrawal Force:
Depends on Mating Jack
- Soldering Requirement:
ANSI/J-Std-001
- Temperature Range: -40°C to +85°C
- U.L. Component Recognition File No: E118169
- Life: Depends on Mating Jack

Materials

- Tip: Nickel-plated copper alloy
- Sleeve: Nickel-plated copper alloy
- Handle: Nickel-plated copper alloy
- Tip Terminal: Copper alloy, electrotin-plated
- Cable Clamp: Copper alloy, electro-tinplated

See Next Page for Ordering Information

DIMENSIONS ARE FOR REFERENCE ONLY $\frac{\text{Inch}}{\text{(mm)}}$

Switchcraft
www.switchcraft.com

5555 North Elston Avenue / Chicago, IL 60630
Phone: 773-792-2700 / Fax: 773-792-2129

JACKS & PLUGS

84 Plug Series

Ordering Information

Part No.	Typical Conductors	Terminals	Mating Jack	Handle	Notes
1/4" Littel Plug Series					
240	2	Screw	11	Black	
245	2	Screw	11	Red	
250	2	Solder	11	Black	
260	2	Screw	11	Black	
270	2	Screw	11	Black	
280	2	Solder	11	Shielded	
281	2	Solder	11	Shielded	Unassembled
580	2	Solder	11	Shielded	Diecast handle
285	2	Solder	11	Shielded	Unassembled
285L	2	Solder	11	Shielded	Larger cable clamp
267	3	Solder	12B	Black	
290	3	Screw	12B	Shielded	
297	3	Solder	12B	Shielded	
299	3	Solder	12B	Shielded	Diecast handle
Heavy Duty Speaker Plugs					
184	2	Solder	11 or Z15J	Shielded	Accepts Cable OD up to .375"
188	2	Solder	11 or Z15J	Shielded	Accepts Cable OD up to .450"
187	2	Solder	11 or Z15J	Shielded	Accepts Cable OD up to .330"
187B	2	Solder	11 or Z15J	Shielded	Black Handle, accepts Cable OD up to .330"
Right Angle 1/4" Plugs					
226	2	Solder	11	Shielded	
228	2	Solder	11	Shielded	Flat handle
236	3	Solder	12B	Shielded	
238	3	Solder	12B		Flat handle
Silent Plug					
172	2	Screw	11	Shielded	
181	2	Solder	11	Shielded	
Miti Plugs					
174S	2	Solder	11 or Z15J	Shielded	Brass finish, spring flex relief

See Pages 88-89 for Mechanical Drawings

Switel

JACKS & PLUGS

Plug Series

85

Tini, Micro, 3.5mm Stereo, Right Angle 3.5mm Stereo, Phono, Right Angle Phono Plugs Series

Switchcraft offers a wide variety of Tini, Micro, 3.5mm, and RCA or Phono plugs. Tini plugs are 2 conductor plugs with plug finger diameters of .141" or 3.57mm. Micro plugs are 2 conductor plugs with plug finger diameters of .097" or 2.47mm. Our 35HD Series are true 3.5mm plugs, available in both straight and right angle versions; and available only in 3 conductor. The RCA or Phono plugs come with either hollow pins or solid pins. The 3502 offers hollow pins and standard size handle, the 3502L offers the same pin, but with a larger handle, accommodating cables up to .290". The 3502A and 3502RA Series offer solid pins and the larger cable clamps and handles. The 3558 Series offers a low cost alternative, with hollow pins and plastic handles.



Specifications

Mechanical

Life rating: 5,000 insertion/
withdrawals
Insertion/Withdrawal Force: 1 lb
(depending on mating jack)

Electrical

Insulation Resistance:
> 100 megohms
Dielectric Withstanding Voltage:
250 VAC

Environmental

Thermal Range: -55°C to +85°C
(non operating); -20°C to 65°C
(operating)
Thermal Shock: Mil-Std 202,
method 107
Humidity: Mil-Std 202,
method 106
Salt Spray: Mil-Std 202,
method 101
(continued on next page)



JACKS & PLUGS

86 Plug Series

Materials

Tip, Rod and Body (also integral coupling collar on lock micro-plug):
Nickel-plated copper alloy
Insulation: Molded thermoplastic
Sleeve Termination and Cable Clamp: Tinned copper alloy

Handle: Nickel-plated copper alloy, or anodized aluminum, or thermoplastic. See factory for details.

Ordering Information

Part No.	Conductors	Terminals	Typical Mating Jack	Handle	Notes
Tini-Plug (.141")					
740	2	Screw	41	Black	
750	2	Solder	41	Black	
755	2	Solder	41	Red	
780	2	Solder	41	Shielded	
Micro-Plugs (.097")					
850	2	Solder	TR2A	Black	
855	2	Solder	TR2A	Red	
851	2	Solder	TR2A	Black	Locking version
880	2	Solder	TR2A	Shielded	
881	2	Solder	TR2A	Shielded	Locking version
3.5mm Stereo Plugs					
35HDNN	3	Solder		Shielded	
35HDBAU	3	Solder		Black Shielded	Gold-plated finger
35HDNAU	3	Solder		Shielded	Gold-plated finger
3.5mm Right Angle Stereo Plugs					
35HDRANN	3	Solder		Shielded	
35HDRABAU	3	Solder		Black Shielded	Gold-plated finger
35HDRAAU	3	Solder		Shielded	Gold-plated finger
Phono Plugs					
3502	2	Solder	3501FP	Shielded	Hollow Pin
3502A	2	Solder	3501FP	Shielded	Large cable clamp, solid pin
3502AAU	2	Solder	3501FP	Shielded	Gold-plated finger
3502ABAU	2	Solder	3501FP	Black shielded	Gold-plated finger
3502L	2	Solder	3501FP	Shielded	Hollow pin, large cable clamp
35581	2	Solder	3501FP	Red	Plastic handle
35582	3	Solder	3501FP	Black	Plastic handle
35585	3	Solder	3501FP	White	Plastic handle
Right Angle Phono Plugs					
3502RA	2	Solder	3501FP	Shielded	
3502RABAU	2	Solder	3501FP	Black Shielded	Gold-plated finger
3502RAAU	2	Solder	3501FP	Shielded	Gold-plated finger

See Pages 90-92 for Mechanical Drawings

Switel

JACKS & PLUGS

Plug Series

87

TT or Bantam, Mil-Style 1/4" Plugs Series

Switchcraft leads the industry when developing innovative TT and MT Style plugs. Our "N" version plugs offer nickel-plated plug fingers to reduce tarnishing and corrosion. Our "NC" version plugs not only offer nickel-plated plug fingers, but also large, easy to use solder cups and terminals, plus easy to use cable clamps that really secure your cable to the plugs.

Specifications

Materials

Tip Rod, Body and Screws:
Copper alloy, natural finish
Terminals (NC Version): Tinned copper alloy
Insulation: Thermoplastic, per Mil-P-22985, Type II, Class 1
Handles: Thermoplastic, Type 6, per Mil-M-20693, Type II
Shielded (NC Version): Machined from copper alloy, nickel-plated



See Page 93 for Mechanical Drawings

Ordering Information

Part No.	Conductors	Terminals	Handle	Notes
TT or Bantam Plugs				
TT253	3	Screw	Black	
TT253N	3	Screw	Black	Nickel-plated finger
TT253NC	3	Solder	Black	Nickel-plated finger
TT254	3	Screw	Red	
TT254N	3	Screw	Red	Nickel-plated finger
TT254NC	3	Solder	Red	Nickel-plated finger
Mil-Style 1/4 Plugs				
480	3	Screw	Black	0.206" OD
482	3	Screw	Red	
482N	3	Screw	Red	Nickel-plated finger
482NC	3	Solder	Red Shielded	Nickel-plated finger
482NCP	3	Solder	Red	Nickel-plated finger
483	3	Screw	Black	
483N	3	Screw	Black	Nickel-plated finger
483NC	3	Screw	Black Shielded	Nickel-plated finger
483NCP	3	Solder	Black	Nickel-plated finger
484	3	Screw	Red	0.206" OD
485NC	3	Solder	Shielded	Nickel-plated finger

JACKS & PLUGS

88

Plug Series Dimension Drawings Littel Plug 1/4" Series

260



No. 260 typical — shown with screw-type terminals and plastic handle.

280 Typical

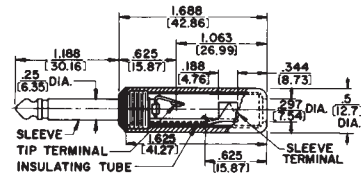

No. 280 typical — shown with solder lug terminals, cord clamp and shielded handle.

188



187BL



No. 187BL (Typical)

Switchcraft

JACKS & PLUGS

Plug Series Dimension Drawings Littel Right Angle 1/4", Silent, Super Heavy Duty Plug Series

228 Right Angle 1/4" Plugs



236 Right Angle 1/4" Plugs



172



181 Silent Plug



174S Super Heavy Duty Plug



DIMENSIONS ARE FOR REFERENCE ONLY
Inch (mm)

JACKS & PLUGS

90

Plug Series Drawings Tini, Micro Plug Series

740, 750 Tini-Plugs



740 Screw Terminals Series



750 Clamp-Lug Terminals

850, 851 Micro Plugs



850 (typical) Series



851 (typical) Series

Switel

JACKS & PLUGS

Plug Series Drawings 35HD 3.5mm Stereo Plug Series

35HDNN, 35HDBAU, 35HDNAU



35HDRANN, 35HDRABAU, 35HDRAAU



DIMENSIONS ARE FOR REFERENCE ONLY $\frac{\text{Inch}}{\text{(mm)}}$

JACKS & PLUGS

92

Plug Series Drawings Phono and Phone Right Angle Plug Series

3502, 3502A, 35581 Phono Plug

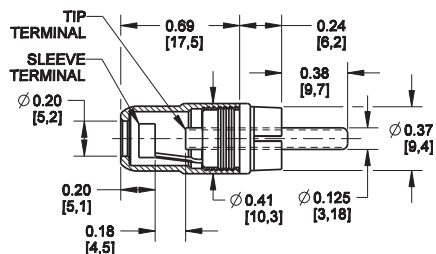

3502 Series

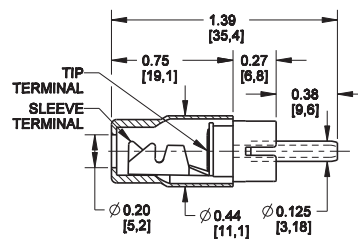

35581 Series

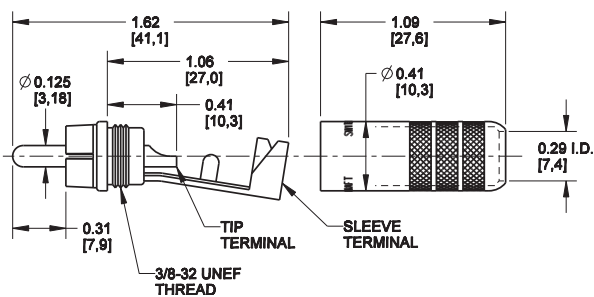

3502A Series

3502RA Plug

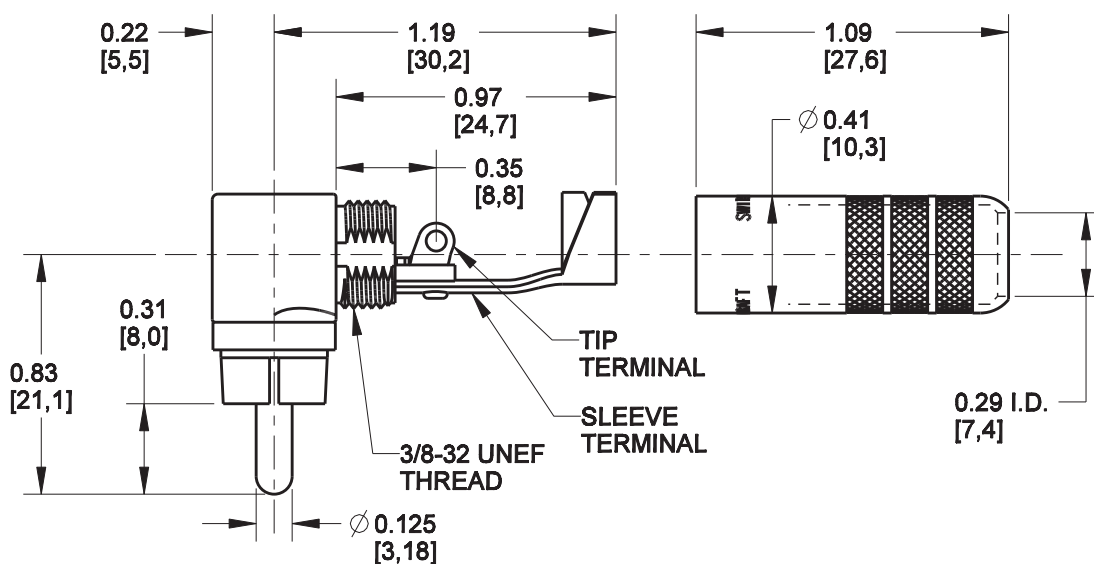

JACKS & PLUGS

Plug Series Drawings TT or Bantam, Mil-Style 1/4" Plug Series

TT253, TT253NC Plug



TT253 Series



TT253NC Series

480, 482, 482NC, 484 Mil-Style 1/4" Plug



480 Series



482NC Series



482 Series



484 Series

DIMENSIONS ARE FOR REFERENCE ONLY $\frac{\text{Inch}}{\text{(mm)}}$

SWITCHES

94 Switch Series Guitar and Knobs, and Broadcast Switch Series

The 12000 Series switches are premium grade switches used primarily in guitars as pick-up switches. The largest names in the industry rely on our switches for quality and durability. Our 84000 Series and PL Series switches are used in broadcast studios, theater lighting, anywhere large illuminated switches are needed.

Specifications - 12000 Series

Electrical

- Contact Ratings: Fine silver contacts rated at 3A, 300W maximum AC non-inductive load standard. Other contacts available
- Leakage Resistance: 1,000 MW or greater
- Dielectric Strength: 250 VDC

Materials

- Frame: Copper alloy, plated (3,000, 13,000); Steel, plated (12,000)
- Bushing and Shaft: Copper alloy, plated
- Springs: Copper alloy
- Knob: Black molded thermoplastic
- Mounting Hardware: Knurled copper alloy locknut T10711, supplied. P10531 hex locknut, special order
- Insulation: Rigid plastic spacers with plastic tubing through stack. Rigid plastic and/or thermoplastic lifters. Thermoplastic cam on actuator end



Note: Knobs must be ordered separately.

Specifications - 8400 Series

Electrical

- Temperature Range: -22°F to 158°F (-30°C to +70°C)
- Dielectric Strength: 1 kV DC
- Leakage Resistance: 1,000 MW or greater

Materials

- Mounting/Retaining Clips and Covers: Steel, plated
- Contact Ratings: Gold crossbar rated at 1A, 200W Maximum AC non-inductive loads (continued on next page)



Switel

(continued from previous page)

Springs: Copper alloy, plated
Lamp Terminals: Copper alloy, plated
Lamp Socket: Zinc, plated
Terminals: Copper alloy, plated,
straight solder lugs
Housing, Escutcheon, Knob,
Actuator and Switching Stacks
Insulation: Molded plastic

Specifications - PL Series

PUSH-LITE Switches Series and
PL Indicators

Contacts

Welded crossbar Gold Alloy,
rated at 2 amps., 200 watts
max., AC non-inductive load.

Electrical

6,000 Minimum Life (Gold
Alloy Contacts) per UL 1054.

Materials

Push-Lite Switch Assemblies:
Housing, Lifters, Switch Modules,
Barriers and Pushbuttons:
Molded Plastics
Contacts Springs: Phosphor
Bronze, Silver Plated
Lamp Terminals: Brass, Silver plated
Lamp Socket, Light Divider and
Yoke Assembly: Nickel Silver
Mounting Bracket and Retaining
Clips: Steel with iridescent
iridite over Cadmium Plating

Series PL Pushbuttons:

Housing, Color Filter Inserts and
Display Screens: High impact
thermoplastic

PL Indicators:

Housing: Molded glass filled
Plastics
Mounting Bracket: Steel, irides-
cent over cadmium Plating.
Lamp Retainer and Terminals:
Nickel Silver.
Display Screen (Pushbutton):
Molded Plastics.

Ordering Information

Part Number	Circuitry	Description
Guitar Switches		
12010	SPST(NC)/SPST(NC)	Straight, nickel finish, riveted silver contacts
12011	SPST(NC)/SPST(NC)	Straight, bright brass finish, riveted silver contacts
12012	SPDT(non-shorting)/SPST(NC)	Right angle, nickel finish, welded silver contacts
12013	SPST(NC)/SPST(NC)	Right angle, nickel finish, welded silver contacts
12014	SPST(NC)/SPST(NC)	Right angle, black finish, welded silver contacts
12015	DPDT(NC)/DPDT(NC)	Right angle, nickel finish, welded silver contacts
12016	SPST(NC)/SPST(NC)	Right angle, bright brass finish, riveted silver contacts
12017	SPST(NC)/SPST(NC)	Right angle, nickel finish, welded gold contacts
Knobs		
T12742		Black
T12745		White
T127410		Ivory
P2912		Amber
Broadcast Switches		
84206L	DPDT	2 Position, locking
84306L	SPDT(non-shorting) both sides	3 Position, locking
84312L	DPDT both sides	3 Position, locking
84324L	DPDT both sides	3 Position, locking
K131		Filter kit, 3 of ea. (amb, blu, grn, red, wht, and yel)
PL106205	DPDT	Momentary, single lamp
PL206205	DPDT	Momentary, twin lamp
PL106705	DPDT	Push-lock/Push-release, single lamp
PL206705	DPDT	Push-lock/Push-release, twin lamp

See Next Page for Mechanical Drawings

SWITCHES

96 Switch Series Drawings Guitar and Knobs, and Broadcast Switch Series

12000 Series RA Lev-R® Switches



84000 Series Lever-Lite® Switches



12000 Series Straight Lev-R® Switches



PL Series Push-Lite® Switches



Switches

DIMENSIONS ARE FOR REFERENCE ONLY $\frac{\text{Inch}}{(\text{mm})}$

Switchcraft[®]
w w w . s w i t c h c r a f t . c o m

5555 North Elston Avenue / Chicago, IL 60630
Phone: 773-792-2700 / Fax: 773-792-2129

INDEX

05AD05.....45	172.....84	340.....64	42A.....68
05AK05.....45	174S.....84	345A.....64	44.....64
05AK25.....45	181.....84	349A.....64	480.....87
05AN05.....45	184.....84	3501FP.....70	482.....87
05AN15.....45	187.....84	3501FR.....70	482N.....87
05AN25.....45	187B.....84	3502.....86	482NC.....87
05AN80.....45	188.....84	3502A.....86	482NCP.....87
05AU05.....45	18QD18.....45	3502AAU.....86	483.....87
05AU80.....45	18QF18.....45	3502ABAU.....86	483N.....87
05BL5M.....53	18QH18.....45	3502L.....86	483NC.....87
05DL5M.....53	20QD20N.....45	3502RA.....86	483NCP.....87
05GM5M.....53	20QF20N.....45	3502RAAU.....86	484.....87
10BF10.....45	20QH20N.....45	3502RABAU.....86	485NC.....87
10BK10.....45	226.....84	3503.....70	516-090-000-301.....20
10BN10.....45	228.....84	3514PC.....70	516-090-000-302.....20
11.....66	236.....84	3517PC.....70	516-120-000-101.....20
111.....66	238.....84	352A.....64	516-120-000-102.....20
112B.....66	240.....84	35581.....86	516-290-500.....20
113BPC1M.....66	245.....84	35582.....86	516-290-590.....20
114B.....66	250.....84	35585.....86	57GB5F.....53
114BPC.....66	2501F.....53	35HDBAU.....86	57PC5F.....53
114BPC1M.....66	2501M.....53	35HDNAU.....86	57PC5FS.....53
114BPCS.....66	2501MP.....53	35HDNN.....86	580.....84
120.....66	25AF25.....45	35HDRAAU.....86	712A.....71
12010.....95	25AK25.....45	35HDRABAU.....86	722A.....71
12011.....95	25AK82.....45	35HDRANN.....86	732A.....71
12012.....95	25AN25.....45	35PM1.....68	740.....86
12013.....95	260.....84	35PM2A.....68	750.....86
12014.....95	267.....84	35RAPC2AV.....68	755.....86
12015.....95	270.....84	35RAPC2BH3.....68	760.....71
12016.....95	280.....84	35RAPC3BH3.....68	760K.....71
12017.....95	281.....84	35RAPC4BH3.....68	765.....71
121.....66	285.....84	35RAPC7J.....68	780.....86
1238.....66	285L.....84	35RAPC7JS.....68	80.....66
125.....68	290.....84	361A.....64	830.....66
128.....66	297.....84	362A.....64	84206L.....95
12A.....66	299.....84	363.....64	84306L.....95
12B.....66	30AK30.....45	365.....64	84312L.....95
131.....66	30AN30.....45	370A.....64	84324L.....95
133.....66	30AR30.....45	374.....64	850.....86
142A.....68	321.....63	376.....64	851.....86
14B.....66	322.....63	377.....64	855.....86
151.....68	323.....63	383A.....63	860.....71
152.....68	324.....63	384A.....63	865.....71
152B.....68	330F1.....64	386A.....63	88.....66
153.....68	330F2.....64	387A.....63	880.....86
154.....68	330P.....64	389.....63	881.....86
155.....68	332A.....64	390.....63	A*F.....46
15AK15.....45	336A.....64	41.....68	A*FB.....46

A*FBAU.....46	E112BL.....68	MD15.....45	MVP32K3*75T.....37
A*FL.....46	E3FSC.....47	MD3.....45	MVP32K3*NT.....37
A*M.....46	E3FSCB.....47	MD6.....45	P*F.....48
A*MB.....46	E3FSCBAU.....47	MT334B.....70	P*FB.....48
A*MBAU.....46	E3MSC.....47	MT48FN.....26	P*M.....48
A*ML.....46	E3MSCB.....47	MT48HN.....26	P*MB.....48
AA*F.....46	E3MSCBAU.....47	MT48K1FN.....24	P2912.....95
AA*FB.....46	EH13942.....52	MT48K1HN.....24	PC142A.....68
AA*FBAU.....46	EBHNC2.....52	MT48K1NN.....24	PD3FSC1.....48
AA*FL.....46	EBHNCSC.....52	MT48K1NS.....24	PD3FSC1AU.....48
AA*M.....46	EHCAT62.....52	MT48K3FN.....24	PD3MSC1.....48
AA*MB.....46	EHRCA2.....52	MT48K3HN.....24	PD3MSC1AU.....48
AA*MBAU.....46	EHRCABNC.....52	MT48K3NN.....24	PL106205.....95
AA*ML.....46	EHUSB2.....52	MT48NN.....26	PL106705.....95
AAA*FBAUZ.....46	HP75BNC1.....54	MT48NS.....26	PL206205.....95
AAA*FBZ.....46	HP75BNC12.....54	MT52FN.....26	PL206705.....95
AAA*FPBAUZ.....46	HP75BNC2.....54	MT52HN.....26	PT1LA.....4
AAA*FPBZ.....46	HP75BNC7.....54	MT52K1FN.....24	PT2B.....4
AAA*FPZ.....46	HP75BNC9.....54	MT52K1HN.....24	QGPK116FB.....32
AAA*FZ.....46	HPCC4F.....51	MT52K1NN.....24	QGPK116MB.....32
AAA*MBAUZ.....46	HPC4RAF.....51	MT52K1NS.....24	QGPK18M8FB.....32
AAA*MBZ.....46	HPCI4F.....51	MT52K3FN.....24	QGPK1B.....32
AAA*MPBAUZ.....46	HPCP410PC.....50	MT52K3HN.....24	QGPK332MFB.....32
AAA*MPBZ.....46	HPCP410RA.....50	MT52K3NN.....24	QGPK3B.....32
AAA*MPZ.....46	HPCP41F.....50	MT52NN.....26	R*FBAUZ.....48
AAA*MZ.....46	HPCP41F1.....50	MT52NS.....26	R*FBZ.....48
B*F.....47	HPCP420PC.....50	MTP24K7.....18	R*FZ.....48
B*FB.....47	HPCP420RA.....50	MTP48K1NO.....14	R*MBAUZ.....48
B*M.....47	HPCP42F.....50	MTP48K1NS.....14	R*MBZ.....48
B*MB.....47	HPCP42F1.....50	MTP48K3BPNS.....18	R*MZ.....48
BPJF**.....70	HPCPK112F.....30	MTP48K3NO.....14	RA49B11.....66
BPJF**AU.....70	HPCPK112F1.....30	MTP48K3NS.....14	RA49C14B.....66
BPJJ**.....70	HPCPK1B.....30	MTP48K3PBNO.....18	RN112APC.....66
BPJJ**AU.....70	HPCPK324F.....30	MTP48K3SNO.....14	RS422H48N081.....12
BPJR**.....70	HPCPK324F1.....30	MTP52K3BPNO.....18	RS422H4N161.....12
BPJR**AU.....70	HPCPK3B.....30	MTPFA48K1NO.....8	RS422H4N162.....12
C*F.....47	HPCPR410PC.....50	MTPFA48K1NS.....8	RS422H4N242.....12
C*FB.....47	HPCPR41F.....50	MTPH48K1NO.....5	RS422V4N081.....12
C*M.....47	HPCPR41F1.....50	MTPH48K1NS.....5	RS422V4N161.....12
C*MB.....47	HPCPR420PC.....50	MTPH48K3NO.....5	RS422V4N162.....12
D*F.....47	HPCPR42F.....50	MTPH48K3NS.....5	RS422V4N242.....12
D*FB.....47	HPCPR42F1.....50	MTPH48K3SNO.....5	RS422V4N322.....12
D*FBAU.....47	J3FS.....48	MVEZNP175T.....42	S3F5M.....63
D*FS.....47	K131.....95	MVJ*75T.....39	S3FM.....63
D*M.....47	K3FS.....48	MVJ*NT.....39	S5F3M.....63
D*MB.....47	K459.....4	MVP32K1*75T.....37	S760.....71
D*MBAU.....47	K460.....4	MVP32K1*NT.....37	S760K.....71
D*MS.....47	MBPK175T.....43	MVP32K2*75T.....37	S765.....71
E111L.....68	MD10.....45	MVP32K2*NT.....37	T127410.....95

INDEX

T12742	95	TTD8	45	VPP24K3HD*75T	34
T12745	95	TTD9	45	VPP24K3HD*NT	34
T3F	48	TTEZN***0	10	VPP24K3SD*75T	34
TA*F	49	TTP96ASFN	28	VPP24K3SD*NT	34
TA*FB	49	TTP96ASHN	28	VPP26K1HD*75T	34
TA*FL	49	TTP96ASNN	28	VPP26K1HD*NT	34
TA*M	49	TTP96K1FN	22	VPP26K1SD*75T	34
TA*MB	49	TTP96K1HN	22	VPP26K1SD*NT	34
TA*ML	49	TTP96K1NN	22	VPP26K3HD*75T	34
TA01	63	TTP96K3BPNS	18	VPP26K3HD*NT	34
TA02	63	TTP96K3FN	22	VPP26K3SD*75T	34
TA04	63	TTP96K3HNN	22	VPP26K3SD*NT	34
TA05	63	TTP96K3NN	22	VSPP	44
TB*M	49	TTP96K5BPNS	18	WMT334B	70
TB*MB	49	TTPFA96K1NO	8	WTT34B	70
TT1	45	TTPFA96K1NS	8	YMT334BN	70
TT10	45	TTPH96K1NO	5	Z15J	66
TT122	45	TTPH96K1NS	5		
TT124	45	TTPH96K3NO	5		
TT126	45	TTPH96K3NS	5		
TT127	45	TTPW96K1HN	16		
TT128	45	TTPW96K1NN	16		
TT2	45	TTPW96K1NS	16		
TT253	87	TTPW96K3HNN	16		
TT253N	87	TTPW96K3NN	16		
TT253NC	87	TTPW96K3NS	16		
TT254	87	TY*F	49		
TT254N	87	VAPK1HD*75T	40		
TT254NC	87	VAPK1HD*NT	40		
TT3	45	VAPK1SD*75T	40		
TT34B	70	VAPK1SD*NT	40		
TT34BN	81	VAPK3HD*75T	40		
TT34BNY	70	VAPK3HD*NT	40		
TT4	45	VAPK3SD*75T	40		
TT5	45	VAPK3SD*NT	40		
TT6	45	VJHD*75TX	36		
TT7	45	VJHD*NTX	36		
TT8	45	VJSD*75TX	36		
TT9	45	VJSD*NTX	36		
TT96EDACNO	20	VMAFN	40		
TT96EDACNS	20	VMPP	44		
TTD1	45	VMVHD*75T	40		
TTD10	45	VMVHD*NT	40		
TTD2	45	VMVSD*75T	40		
TTD3	45	VMVSD*NT	40		
TTD4	45	VPP24K1HD*75T	34		
TTD5	45	VPP24K1HD*NT	34		
TTD6	45	VPP24K1SD*75T	34		
TTD7	45	VPP24K1SD*NT	34		

Switel



Компания «ЭлектроПласт» предлагает заключение долгосрочных отношений при поставках импортных электронных компонентов на взаимовыгодных условиях!

Наши преимущества:

- Оперативные поставки широкого спектра электронных компонентов отечественного и импортного производства напрямую от производителей и с крупнейших мировых складов;
- Поставка более 17-ти миллионов наименований электронных компонентов;
- Поставка сложных, дефицитных, либо снятых с производства позиций;
- Оперативные сроки поставки под заказ (от 5 рабочих дней);
- Экспресс доставка в любую точку России;
- Техническая поддержка проекта, помощь в подборе аналогов, поставка прототипов;
- Система менеджмента качества сертифицирована по Международному стандарту ISO 9001;
- Лицензия ФСБ на осуществление работ с использованием сведений, составляющих государственную тайну;
- Поставка специализированных компонентов (Xilinx, Altera, Analog Devices, Intersil, Interpoint, Microsemi, Aeroflex, Peregrine, Syfer, Eurofarad, Texas Instrument, Miteq, Cobham, E2V, MA-COM, Hittite, Mini-Circuits, General Dynamics и др.);

Помимо этого, одним из направлений компании «ЭлектроПласт» является направление «Источники питания». Мы предлагаем Вам помощь Конструкторского отдела:

- Подбор оптимального решения, техническое обоснование при выборе компонента;
- Подбор аналогов;
- Консультации по применению компонента;
- Поставка образцов и прототипов;
- Техническая поддержка проекта;
- Защита от снятия компонента с производства.



Как с нами связаться

Телефон: 8 (812) 309 58 32 (многоканальный)

Факс: 8 (812) 320-02-42

Электронная почта: org@eplast1.ru

Адрес: 198099, г. Санкт-Петербург, ул. Калинина, дом 2, корпус 4, литера А.