

200mW, 4 PIN DIP Phototransistor Photocoupler

FEATURES

- Current transfer ratio
(CTR: MIN.80% at $I_F=5\text{mA}$, $V_{CE}=5\text{V}$)
- High isolation voltage between input and output
($V_{iso}=5000\text{V rms}$)
- Creepage distance $> 7.62\text{mm}$
- UL Recognized File # E478892
- Compliant to RoHS directive 2011/65/EU and in accordance to WEEE 2002/96/EC
- Halogen-free according to IEC 61249-2-21

APPLICATIONS

- Programmable controllers
- System appliances, measuring instruments
- Telecommunication equipments
- Home appliances, such as fan heaters, etc
- Signal transmission between circuits of different potentials and impedances

MECHANICAL DATA

- Case: DIP-4 , DIP-4M , SOP-4
- Molding compound: UL flammability classification rating 94V-0
- Moisture sensitivity level: level 1, per J-STD-020
- Packing code with suffix "G" means green compound (halogen-free)
- Terminal: Matte tin plated leads, solderable per J-STD-002
- Meet JESD 201 class 1A whisker test
- Polarity: Indicated by cathode band

KEY PARAMETERS		
PARAMETER	VALUE	UNIT
CTR	80-600	%
V_{CEO}	80	V
P_{tot}	200	mW
I_C	50	mA
V_{iso}	5000	Vrms
Package	DIP-4 DIP-4M SOP-4	
Configuration	Single Dice	

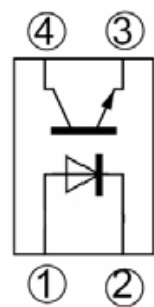
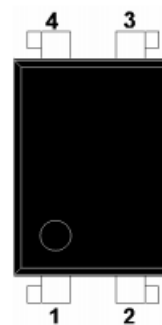
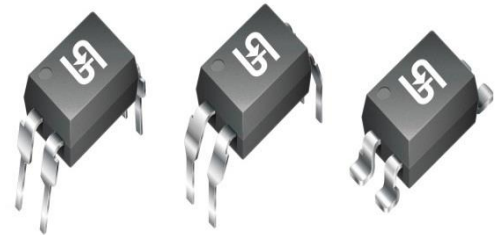

ABSOLUTE MAXIMUM RATINGS ($T_A = 25^\circ\text{C}$ unless otherwise noted)				
PARAMETER		SYMBOL	PART NUMBER	UNIT
Input	Forward current	I_F	50	mA
	Reverse voltage	V_R	6	V
	Power dissipation	P	70	mW
Output	Collector-emitter voltage	V_{CEO}	80	V
	Emitter-collector voltage	V_{ECO}	6	V
	Collector current	I_C	50	mA
	Collector power dissipation	P_C	150	mW
Total power dissipation		P_{tot}	200	mW
Isolation voltage		V_{iso}	5000	Vrms
Rated impulse isolation voltage		V_{IOTM}	6000	V
Rated repetitive peak isolation voltage		V_{IORM}	630	V
Operating temperature		T_{opr}	-40 to +100	$^\circ\text{C}$
Storage temperature		T_{stg}	-55 to +125	$^\circ\text{C}$
Soldering temperature		T_{sol}	260	$^\circ\text{C}$

ELECTRICAL SPECIFICATIONS ($T_A = 25^\circ\text{C}$ unless otherwise noted)							
PARAMETER		CONDITIONS	SYMBOL	MIN	TYP	MAX	UNIT
Input	Forward voltage	$I_F=20\text{mA}$	V_F		1.2	1.4	V
	Reverse current	$V_R=4\text{V}$	I_R			10	μA
	Terminal capacitance	$V=0, f=1\text{kHz}$	C_t		30	250	pF
Output	Collector dark current	$V_{CE}=20\text{V}, I_F=0$	I_{CEO}			10^{-7}	A
	Collector-emitter breakdown voltage	$I_C=0.1\text{mA}, I_F=0$	BV_{CEO}	80			V
	Emitter-collector breakdown voltage	$I_E=10\mu\text{A}, I_F=0$	BV_{ECO}	6			V
Transfer Characteristics	Collector current		I_C	2.5		30	mA
	Current transfer ration(Note 1)	$I_F=5\text{mA}, V_{CE}=5\text{V}$	CTR	80		600	%
	Collector-emitter saturation voltage	$I_F=20\text{mA}, I_C=1\text{mA}$	$V_{CE(sat)}$		0.1	0.2	V
	Isolation resistance	DC500V, 40 to 60%RH	R_{ISO}	5×10^{10}	10^{11}		Ω
	Floating capacitance	$V=0, f=1\text{MHz}$	C_f		0.6	1.0	pF
	Cut-off frequency	$V_{CE}=5\text{V}, I_C=2\text{mA}, R_L=100\Omega, -3\text{dB}$	f_c		80		KHz
	Response time	Rise time	$V_{CE}=2\text{V}, I_C=2\text{mA}, R_L=100\Omega$	t_r		4	18
Fall time			t_f		3	18	μs

Notes:

1. Classification table of current transfer ratio is shown below

RANK TABLE OF CURRENT TRANSFER RATIO, CTR

RANK MARK	MIN (%)	MAX (%)
A	80	160
B	130	260
C	200	400
D	300	600

ORDERING INFORMATION				
PART NO. (Note 1&2)	PACKING CODE	PACKING CODE SUFFIX	PACKAGE	PACKING
TPC817x	C9	G	DIP-4	100 / TUBE
TPC817Mx	C9		DIP-4M (Leads with 0.4" spacing)	100 / TUBE
TPC817S1x	RA		SOP-4	2K / 13" Reel

Notes:

1. "x" defines CTR rank from "A" to "D"
2. Whole series with green compound

EXAMPLE				
EXAMPLE P/N	PART NO.	PACKING CODE	PACKING CODE SUFFIX	DESCRIPTION
TPC817A C9G	TPC817A	C9	G	Green compound

CHARACTERISTICS CURVES

($T_A = 25^\circ\text{C}$ unless otherwise noted)

Fig. 1 Forward Current vs. Ambient Temperature

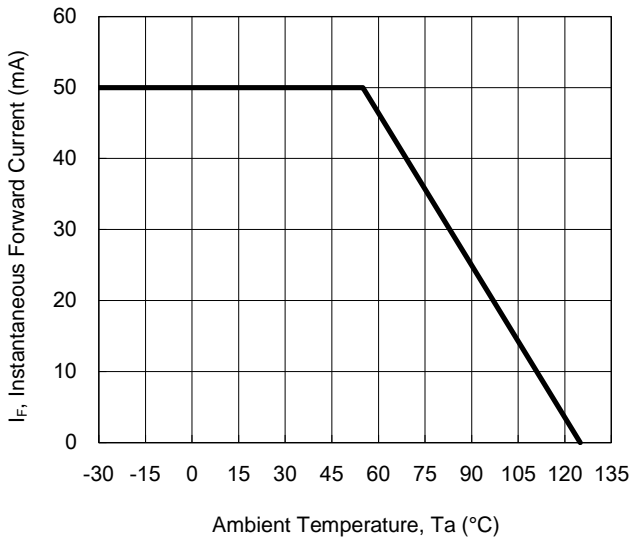

Fig.2 Collector Power Dissipation vs. Ambient Temperature

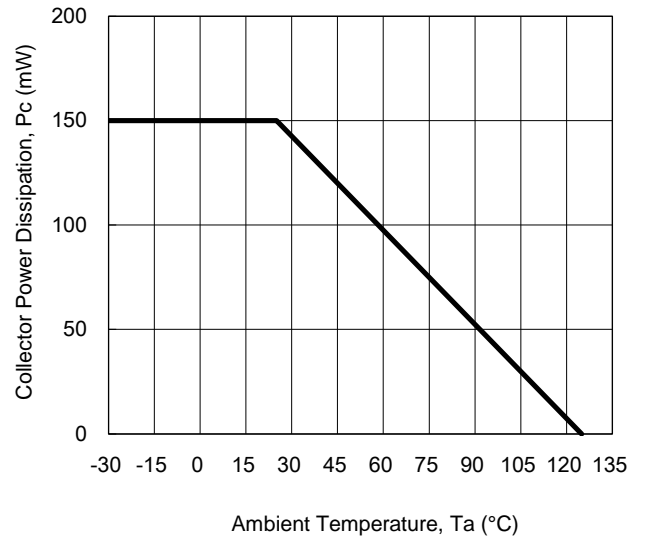

Fig.3 Collector-Emitter Saturation Voltage vs Forward Current

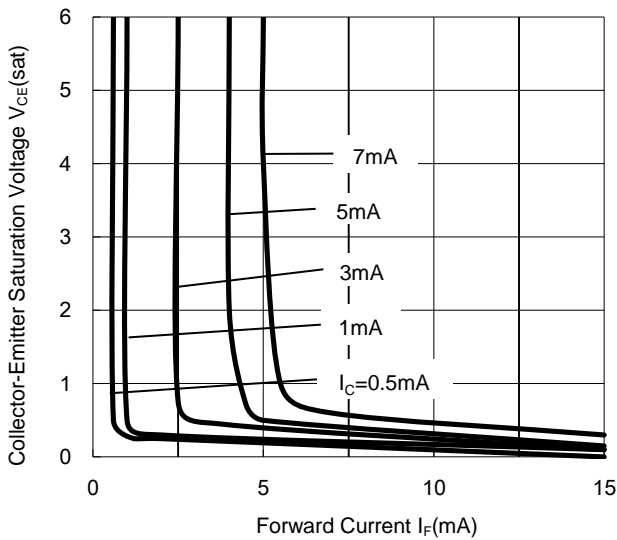

Fig.4 Forward Current vs. Forward Voltage



CHARACTERISTICS CURVES

($T_A = 25^\circ\text{C}$ unless otherwise noted)

Fig. 5 Current Transfer Ratio vs. Forward Current

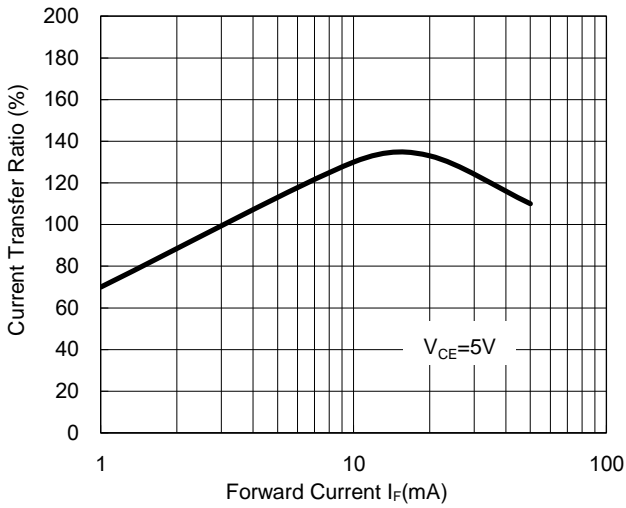

Fig.6 Collector Current vs. Collector-Emitter Voltage

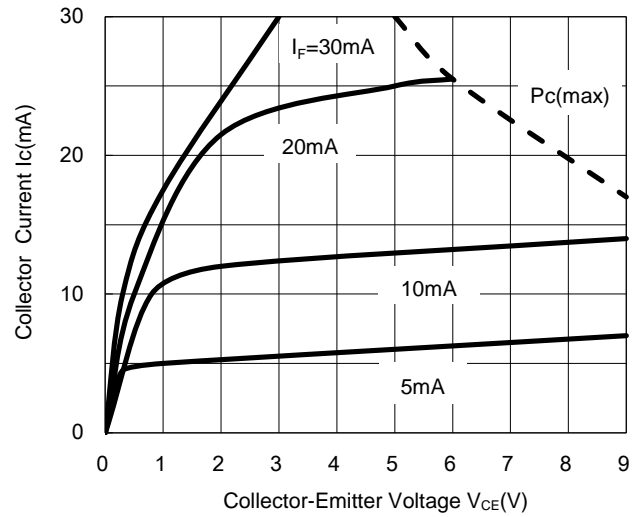

Fig.7 Relative Current Transfer Ratio vs. Ambient Temperature



Fig.8 Collector-emitter Saturation Voltage vs. Ambient Temperature



CHARACTERISTICS CURVES

($T_A = 25^\circ\text{C}$ unless otherwise noted)

Fig. 9 Collector Dark Current vs. Ambient Temperature

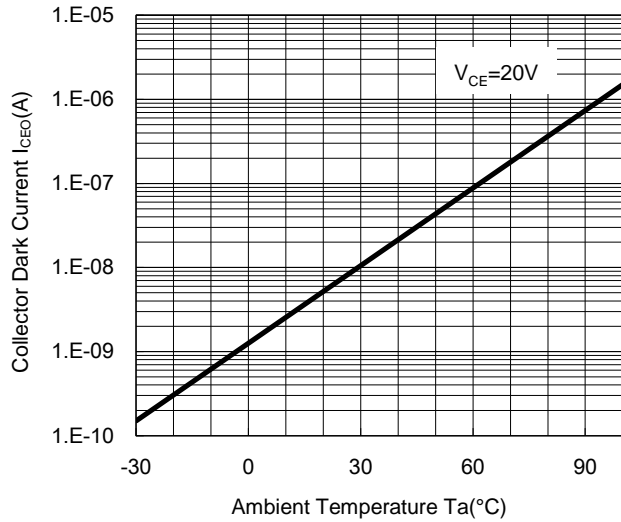
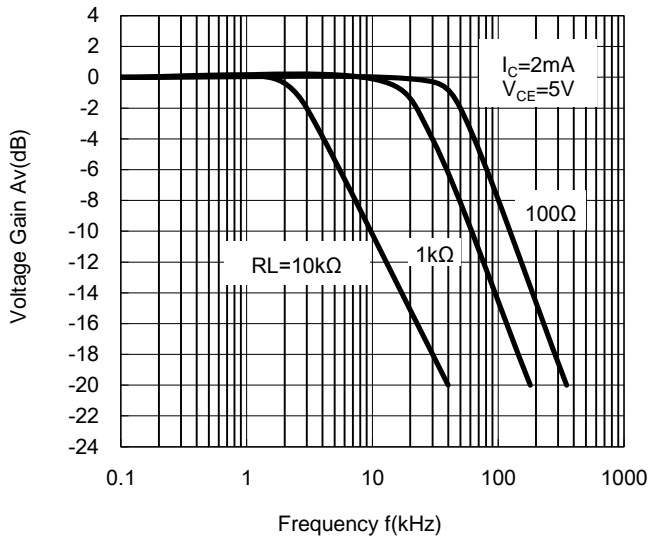

Fig.10 Response Time vs. Load Resistance



Fig.11 Frequency Response



TEST CIRCUIT RESPONSE TIME

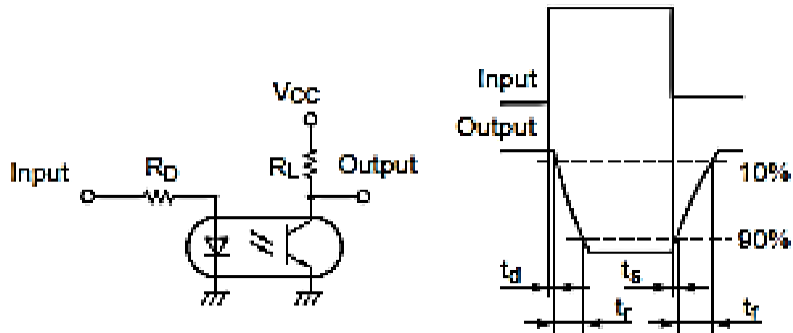

TEST CIRCUIT FOR FREQUENCY RESPONSE

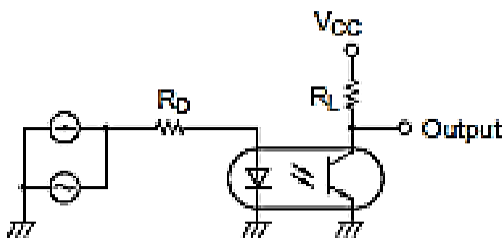

PACKAGE OUTLINE DIMENSION

DIP-4



DIM.	Unit(mm)	
	Min	Max
A	6.40	6.60
B	4.50	4.70
C	7.90	8.30
D	3.28	3.68
E	2°	8°
F	1.25 typ.	
H	2.70	2.90
J	0.23	0.26
K	8.86	9.31
L	0.50 typ.	
M	2.44	2.64
N	0.40 typ.	

DIP-4M (Leads with 0.4" spacing)



DIM.	Unit(mm)	
	Min	Max
A	6.40	6.60
B	4.50	4.70
C	7.90	8.30
D	3.28	3.68
F	1.25 typ.	
G	0.40 typ.	
J	0.23	0.26
K	9.86	10.46
L	0.50 typ.	
M	2.44	2.64
N	2.40	2.90

PACKAGE OUTLINE DIMENSION



DIM.	Unit(mm)	
	Min	Max
A	6.40	6.60
B	4.50	4.70
C	7.90	8.30
D	3.28	3.68
F	1.25 typ.	
G	0.40 typ.	
H	0.00	0.20
J	0.90	1.20
K	9.80	10.30
L	1.25 typ.	
M	2.49	2.69

MARKING



Notes :

- 817: Product type
- B: CTR rank mark
- YWW: Date code

Notice

Specifications of the products displayed herein are subject to change without notice. TSC or anyone on its behalf, assumes no responsibility or liability for any errors or inaccuracies.

Information contained herein is intended to provide a product description only. No license, express or implied, to any intellectual property rights is granted by this document. Except as provided in TSC's terms and conditions of sale for such products, TSC assumes no liability whatsoever, and disclaims any express or implied warranty, relating to sale and/or use of TSC products including liability or warranties relating to fitness for a particular purpose, merchantability, or infringement of any patent, copyright, or other intellectual property right.

The products shown herein are not designed for use in medical, life-saving, or life-sustaining applications. Customers using or selling these products for use in such applications do so at their own risk and agree to fully indemnify TSC for any damages resulting from such improper use or sale.



Компания «ЭлектроПласт» предлагает заключение долгосрочных отношений при поставках импортных электронных компонентов на взаимовыгодных условиях!

Наши преимущества:

- Оперативные поставки широкого спектра электронных компонентов отечественного и импортного производства напрямую от производителей и с крупнейших мировых складов;
- Поставка более 17-ти миллионов наименований электронных компонентов;
- Поставка сложных, дефицитных, либо снятых с производства позиций;
- Оперативные сроки поставки под заказ (от 5 рабочих дней);
- Экспресс доставка в любую точку России;
- Техническая поддержка проекта, помощь в подборе аналогов, поставка прототипов;
- Система менеджмента качества сертифицирована по Международному стандарту ISO 9001;
- Лицензия ФСБ на осуществление работ с использованием сведений, составляющих государственную тайну;
- Поставка специализированных компонентов (Xilinx, Altera, Analog Devices, Intersil, Interpoint, Microsemi, Aeroflex, Peregrine, Syfer, Eurofarad, Texas Instrument, Miteq, Cobham, E2V, MA-COM, Hittite, Mini-Circuits, General Dynamics и др.);

Помимо этого, одним из направлений компании «ЭлектроПласт» является направление «Источники питания». Мы предлагаем Вам помощь Конструкторского отдела:

- Подбор оптимального решения, техническое обоснование при выборе компонента;
- Подбор аналогов;
- Консультации по применению компонента;
- Поставка образцов и прототипов;
- Техническая поддержка проекта;
- Защита от снятия компонента с производства.



Как с нами связаться

Телефон: 8 (812) 309 58 32 (многоканальный)

Факс: 8 (812) 320-02-42

Электронная почта: org@eplast1.ru

Адрес: 198099, г. Санкт-Петербург, ул. Калинина, дом 2, корпус 4, литера А.