

5.5nV/ $\sqrt{\text{Hz}}$ Low Noise, 500 μA low Power, Rail-to-Rail Output CMOS Operational Amplifier

FEATURES

- Equivalent Input Noise Voltage
 - f=10Hz 11nV/ $\sqrt{\text{Hz}}$
 - f=1kHz 5.5nV/ $\sqrt{\text{Hz}}$
- Supply Current 500 μA typ.
- Gain Bandwidth Product 4.4MHz
- Slew Rate 1.1V/ μs
- Supply Voltage
 - Single Supply 1.8V to 5.5V
 - Dual Supply $\pm 0.9\text{V}$ to $\pm 2.75\text{V}$
- Rail-to-Rail Output ($R_L=10\text{k}\Omega$) 50mV from rail
- Ground Sense
- Common-Mode
 - Input Voltage Range $V_{SS}-0.1\text{V}$ to $V_{DD}-0.9\text{V}$
- Input Offset Voltage 2mV max.
- Input Offset Voltage Drift 1.5 $\mu\text{V}/^\circ\text{C}$ typ.
- RF-Noise Immunity
- Package SC-88A

APPLICATIONS

- Low-noise microphone amplifier
- Photodiode preamplifier
- Shock Sensor application
- Acceleration sensor application
- Security equipment
- Wireless LAN
- Radio systems

DESCRIPTION

The NJU77806 is a single low noise rail-to-rail output CMOS operational amplifier offer a low input voltage noise density of 5.5nV/ $\sqrt{\text{Hz}}$ at 1kHz while consuming only 500 μA of supply current, and have wide gain bandwidth of 4.4MHz and slew rate of 1.1V/ μs . These characteristics makes NJU77806 ideal when excellent performance is required in low noise and low power applications.

The very low noise of 5.5nV/ $\sqrt{\text{Hz}}$ at 1kHz and low 1/f noise of 11nV/ $\sqrt{\text{Hz}}$ at 10Hz while consuming only 500 μA of supply current, give the NJU77806 the wide dynamic range necessary for preamps in microphones, audio amplifiers, active filters and sensor amplifiers.

NJU77806 guaranteed from 1.8V to 5V specifications. In addition to low noise and low supply current, the NJU77806 operate on supplies as low as 1.8V. These features makes NJU77806 ideal for battery powered applications.

The NJU77806 is high RF-immunity to reduce malfunctions caused by RF noises from mobile phones and others.

The NJU77806 is available in space saving 5-pin SC-88A. The small package saves space on PC boards, and enables the design of small portable electronic devices.

TYPICAL CHARACTERISTIC

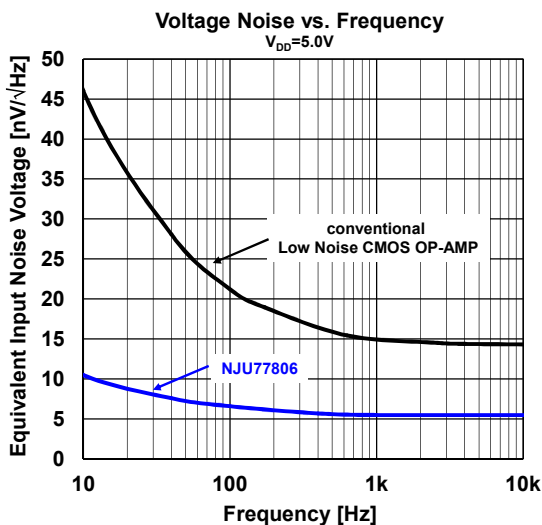

PIN CONFIGURATION

Pin Function	<p>(Top View)</p>
Package	<p>SC-88A</p>
Product Name	NJU77806F3

■ ABSOLUTE MAXIMUM RATINGS

PARAMETER	SYMBOL	RATING	UNIT
Supply Voltage	V_{DD}	7	V
Input Voltage	V_{ICM}	$V_{SS} - 0.3$ to $V_{DD} + 0.3$	V
Differential Input Voltage ⁽¹⁾	V_{ID}	± 7 ⁽²⁾	V
Power Dissipation ⁽³⁾ SC-88A	P_D	(2-layer) 280	mW
Operating Temperature Range	T_{opr}	-40 to +105	°C
Storage Temperature Range	T_{stg}	-55 to +125	°C

(1) Differential voltage is the voltage difference between +INPUT and -INPUT.

(2) For supply voltage less than +7V, the absolute maximum rating is equal to the supply voltage.

(3) Power dissipation is the power that can be consumed by the IC at $T_a=25^\circ\text{C}$, and is the typical measured value based on JEDEC condition.

When using the IC over $T_a=25^\circ\text{C}$ subtract the value $[\text{mW}/^\circ\text{C}] = P_D / (T_{stg}(\text{MAX}) - 25)$ per temperature.

2-layer: EIA/JEDEC STANDARD Test board (76.2x114.3x1.6mm, 2layers, FR-4) mounting

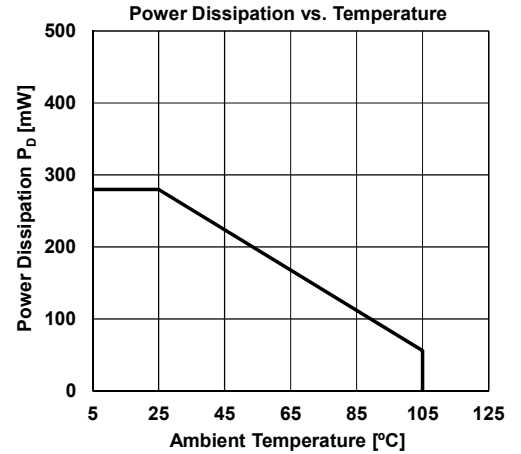

■ RECOMMENDED OPERATING CONDITIONS ($T_a=25^\circ\text{C}$)

PARAMETER	SYMBOL	TEST CONDITION	MIN.	TYP.	MAX.	UNIT
Supply Voltage	V_{DD}		1.8	-	5.5	V

■ ELECTRICAL CHARACTERISTICS

($V_{DD}=1.8$ to $5.0V$, $V_{SS}=0V$, $V_{ICM}=V_{DD}/2$, $T_a=25^{\circ}C$, unless otherwise noted.)

PARAMETER	SYMBOL	TEST CONDITION	MIN.	TYP.	MAX.	UNIT
DC CHARACTERISTICS						
Supply Current	I_{DD}	No Signal	-	500	650	μA
Input Offset Voltage	V_{IO}		-	0.7	2	mV
Input Offset Voltage Drift	$\Delta V_{IO}/\Delta T$	$T_a = -40^{\circ}C$ to $105^{\circ}C$	-	1.5	-	$\mu V/^{\circ}C$
Input Bias Current	I_B		-	1	-	pA
Input Offset Current	I_{IO}		-	1	-	pA
Input capacitance	C_{IN}		-	17	-	pF
Voltage Gain	A_V	$R_L=10k\Omega$ to $V_{DD}/2$	70	100	-	dB
Common-Mode Rejection Ratio	CMR	$V_{ICM}=-0.1V$ to $V_{DD}-0.9V$	70	100	-	dB
Supply Voltage Rejection Ratio	SVR	$V_{DD}=1.8V$ to $5.5V$	70	100	-	dB
Common-Mode Input Voltage Range	V_{ICM}	CMR ≥ 70 dB	-0.1	-	$V_{DD}-0.9$	V
High-Level Output Voltage	V_{OH}	$R_L=10k\Omega$ to $V_{DD}/2$ $I_{source}=1.5mA$	$V_{DD}-0.1$ $V_{DD}-0.15$	$V_{DD}-0.05$ $V_{DD}-0.1$	-	V
Low-Level Output Voltage	V_{OL}	$R_L=10k\Omega$ to $V_{DD}/2$ $I_{sink}=1.5mA$	-	0.05 0.1	0.1 0.15	
AC CHARACTERISTICS						
Slew Rate	SR	$G_V=14$ dB	-	1.1	-	V/ μs
Gain Bandwidth Product	GBP	$G_V=40$ dB, $f=100$ kHz	-	4.4	-	MHz
Unity Gain Frequency	f_T	$G_V=40$ dB	-	2.4	-	MHz
Equivalent Input Noise Voltage	V_{NI}	$f=1$ kHz $f=10$ Hz	-	5.5 11	-	nV/ \sqrt{Hz}
	$V_{NI(PP)}$	$f=0.1$ Hz to 10 Hz	-	0.25	-	μV_{pp}
Total Harmonic Distortion + Noise	THD+N	$G_V=20$ dB, $f=1$ kHz, LPF=80kHz $V_{DD}=5.0V$, $V_O=4V_{pp}$	-	0.005	-	%
		$V_{DD}=1.8V$, $V_O=1.5V_{pp}$	-	0.01	-	

Note

The closed gain should be 14dB(5V/V) or higher to prevent the oscillation. Unity gain follower application may cause the oscillation. When the closed gain is lower than 14dB, please use a compensation capacitor (CF: about 20pF), parallel with the feedback resistor R_F to avoid oscillation. Details are shown on Input Capacitance of Application note.

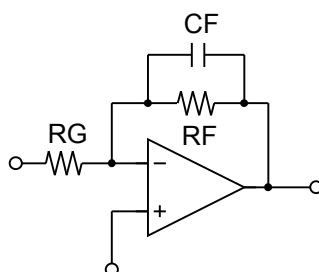

■ TYPICAL CHARACTERISTICS

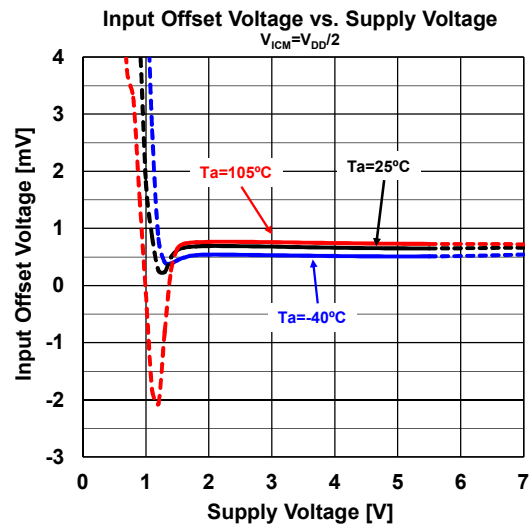
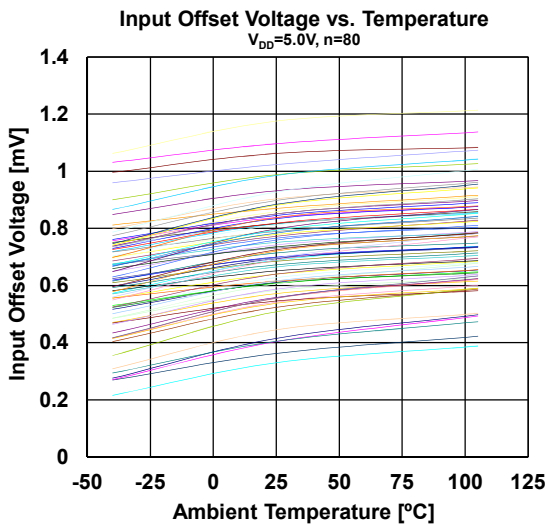
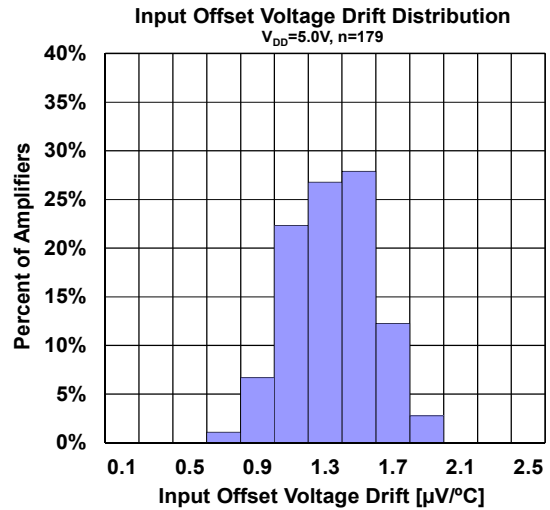
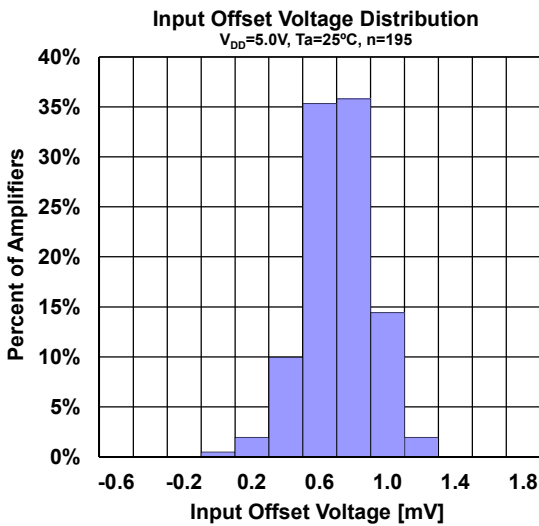
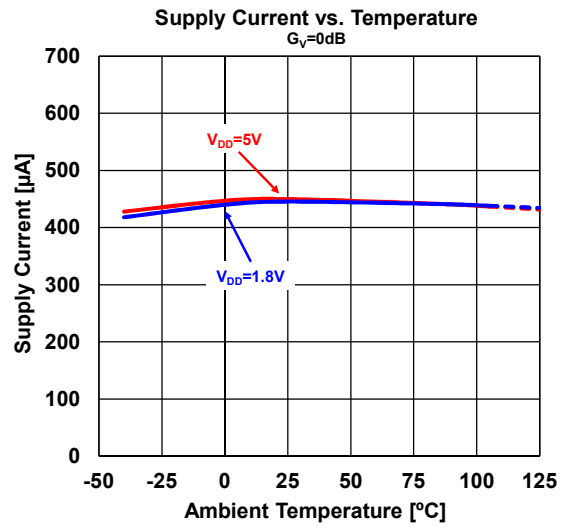
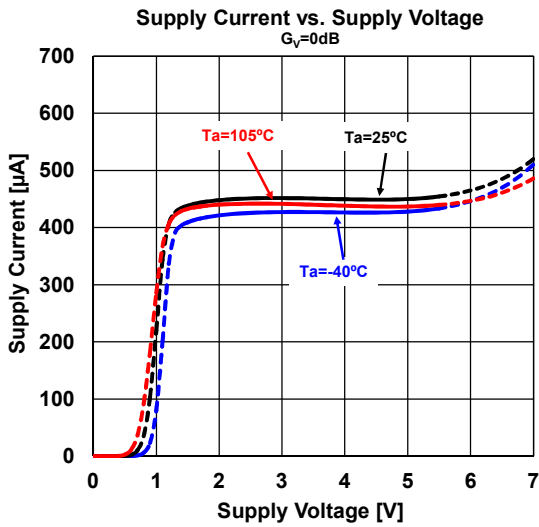

■ TYPICAL CHARACTERISTICS

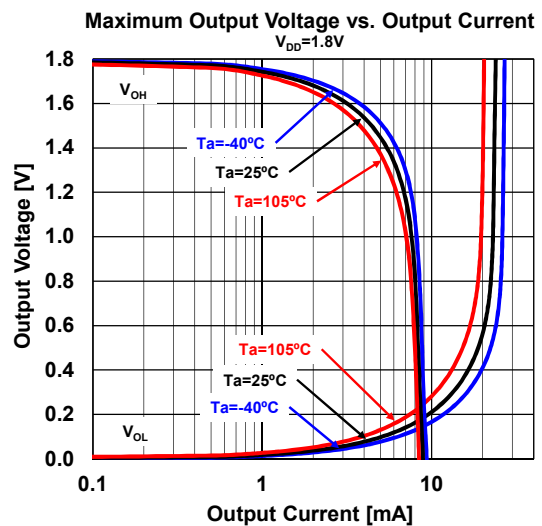
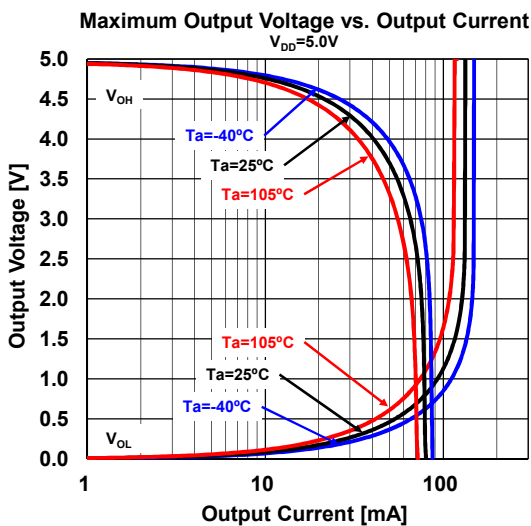
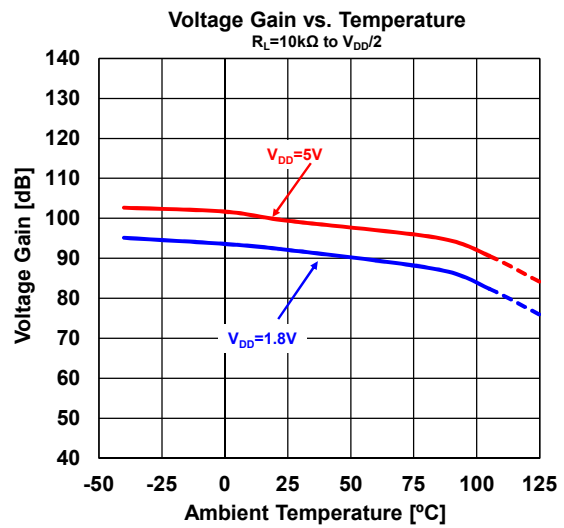
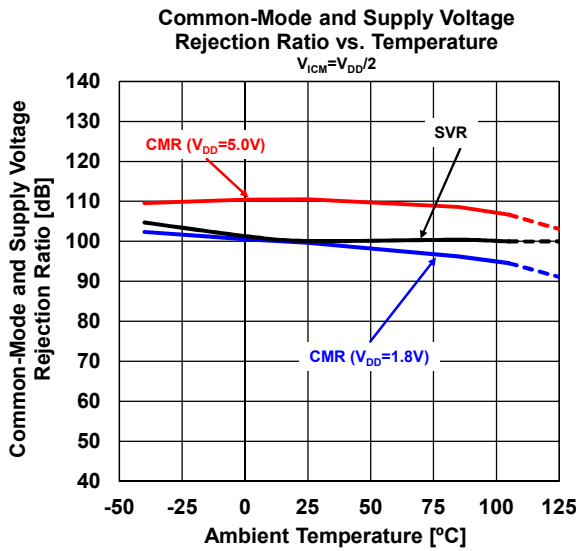
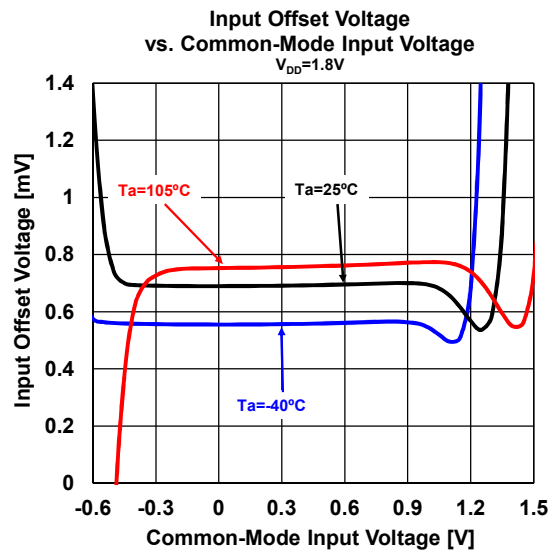
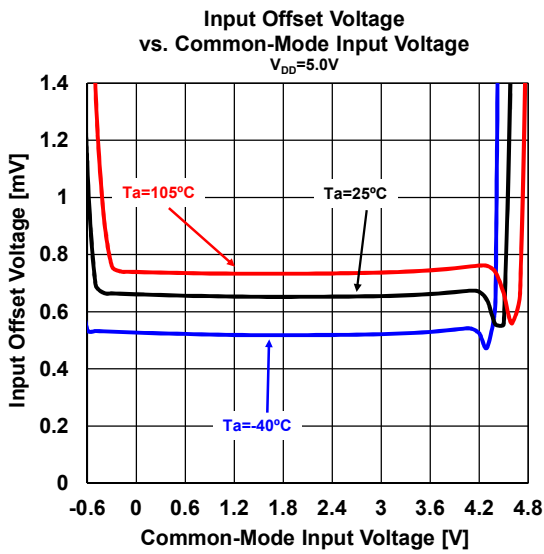

■ TYPICAL CHARACTERISTICS

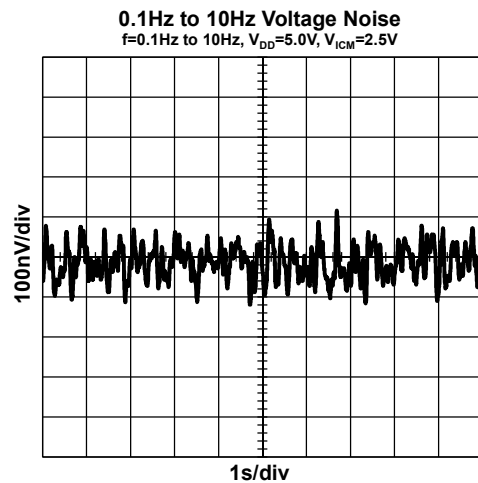
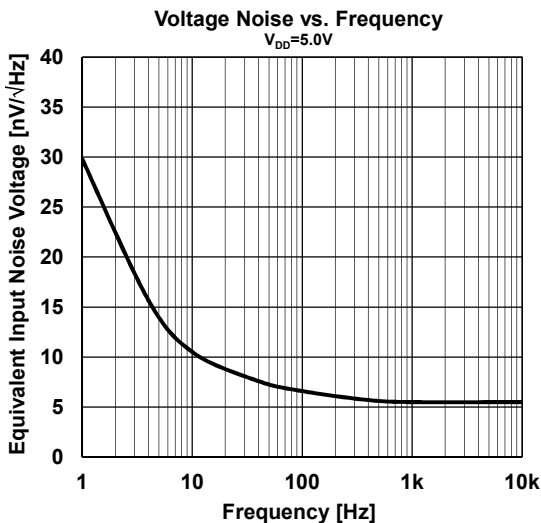
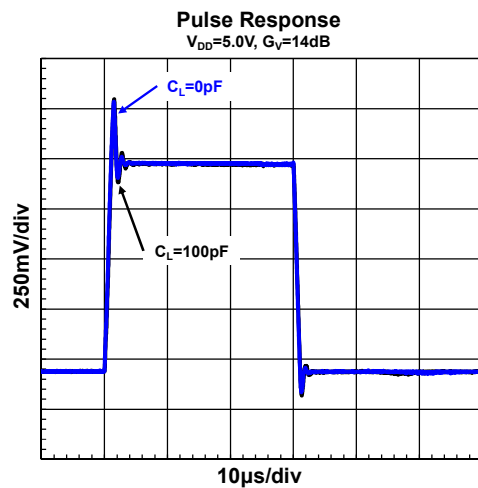
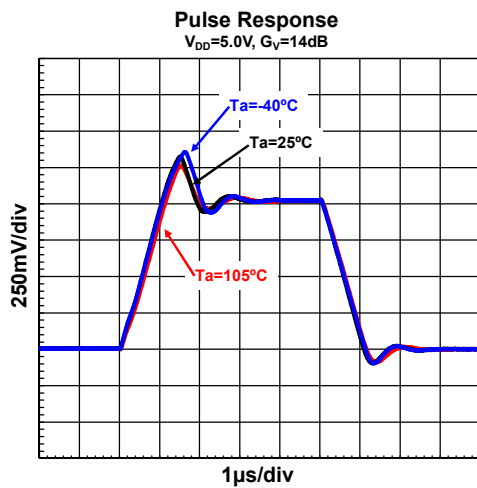
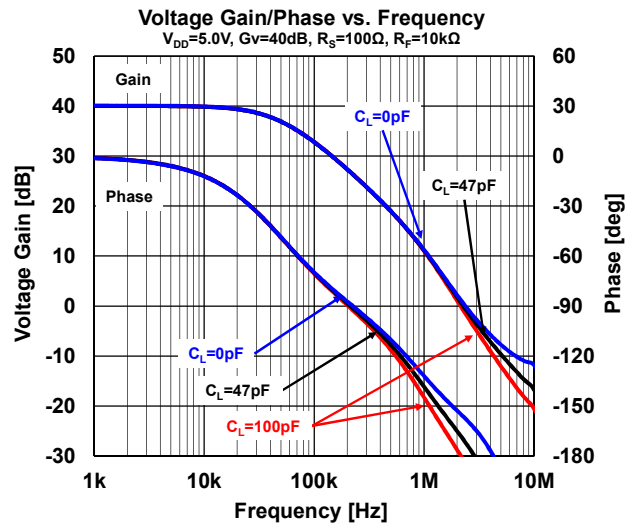
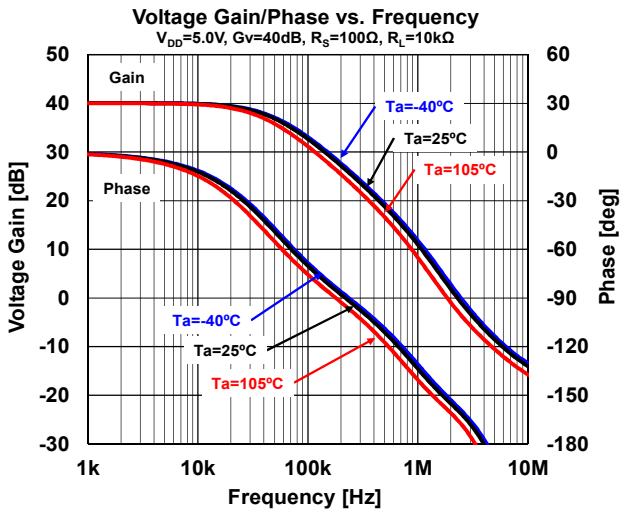

■ TYPICAL CHARACTERISTICS

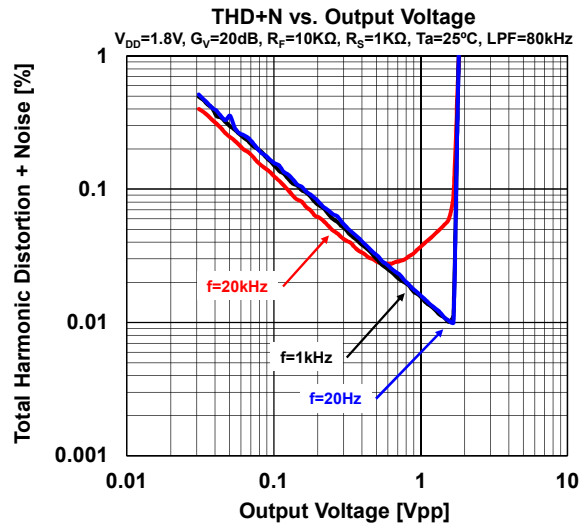
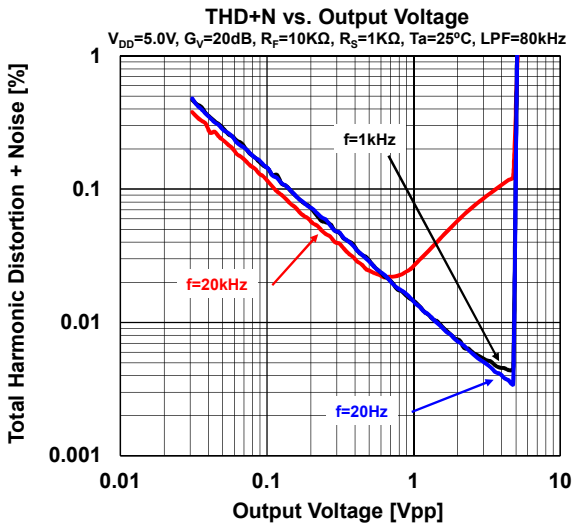

■ APPLICATION NOTE

■ Transimpedance amplifier

NJU77806 is CMOS input operational amplifier, and have high input impedance. And also very low power and low noise makes NJU77806 ideal for transimpedance amplifier requiring low supply current applications.

A typical transimpedance amplifier is shown in Figure1. The output voltage of amplifier is given by the equation $V_{OUT} = -I_{IN} \cdot R_F$. Since the output voltage swing of amplifier is limited, R_F should be selected such that all possible values of I_{IN} can be detected.

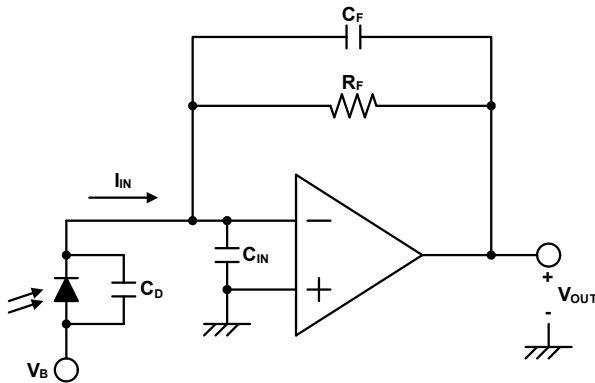

Figure1. Transimpedance amplifier

The following parameters are used to design a transimpedance amplifier: the photodiode capacitance, C_D ; the amplifier input capacitance, C_{IN} . These capacitance and R_F generate a phase lag which causes gain-peaking and can destabilized circuit. The essential component for obtaining a maximally flat response is feedback capacitor. C_F . A feedback capacitance C_F is usually added in parallel with R_F to maintain circuit stability and to control the frequency response. To maximally flat, 2nd order response, R_F and C_F should be chosen by using below equation.

$$C_F = \sqrt{\frac{C_{IN} + C_D}{GBP \times 2\pi \times R_F}}$$

■ Audio preamplifier with band pass filtering

With $11nV/\sqrt{Hz}$ at 10Hz low input voltage noise and $500\mu A$ low supply current, the NJU77806 is ideal for audio applications. In addition, low supply voltage operation, wide gain bandwidth and low harmonic distortion can be used to design a preamplifier in microphone and portable battery powered audio applications.

Two amplifier circuits are shown in Figure2 and Figure3. Figure2 is an inverting amplifier, with a $10k\Omega$ feedback resistor, R_2 , and $1k\Omega$ input resistor, R_1 , and hence provides a gain of -10. Figure3 is a non-inverting amplifier, using the same values of R_1 and R_2 , and provides a gain of 11. In either of these circuits, the coupling capacitor C_1 and feedback

resistor R_1 decides the lower frequency at which the circuit starts providing gain, while the feedback capacitor C_2 and feedback resistor R_2 decides the frequency which the gain starts dropping off.

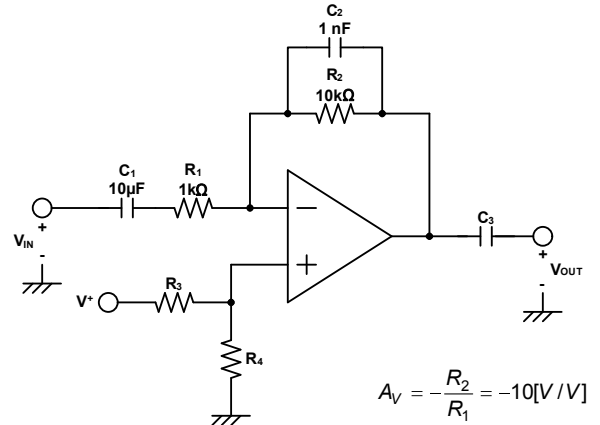

$$A_V = -\frac{R_2}{R_1} = -10[V/V]$$

Figure2. Inverting audio amplifier

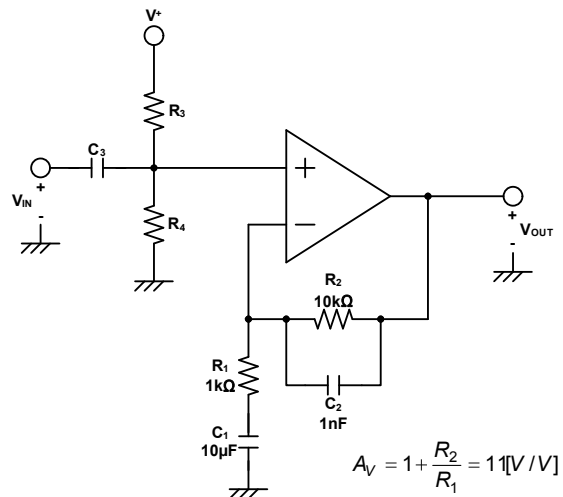

$$A_V = 1 + \frac{R_2}{R_1} = 11[V/V]$$

Figure3. Non inverting audio amplifier

■ APPLICATION NOTE

■ Input Capacitance

The NJU77806 has a very low input bias current and low voltage noise while consuming only 500µA of supply current, however, to obtain this performance a large CMOS input stage is used, which adds to the input capacitance of 17pF. At high frequency the input capacitance interacts with the input and the feedback impedances to create a pole, which results in lower phase margin and gain peaking. This can be controlled by being selective in the use of feedback resistors, as well as by using a feedback capacitance.

Figure4 is an inverting amplifier. As shown in Figure5, as the values of R_F and R_S are increased, gain peaking are increased, which in turn decreases the bandwidth of the amplifier. Whenever possible, it is best to choose smaller feedback resistors.

Next, adding a capacitor to the feedback path will decrease the peaking. Figure6 shows the frequency response with different values of C_F . Adding the capacitance of 20pF removes the peak. The value of C_F should be chosen by used feedback resistors, R_F and input capacitance, C_{IN} .

The NJU77806 recommend to operate gain of 14dB(5V/V)., However by using these techniques as shown Figure7, it is enable to improve the stability less than the gain of 14dB.

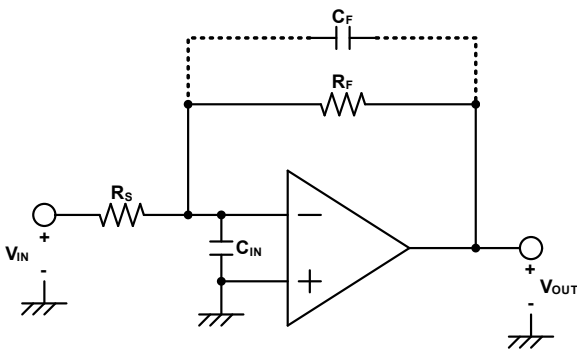

Figure4. Inverting amplifier

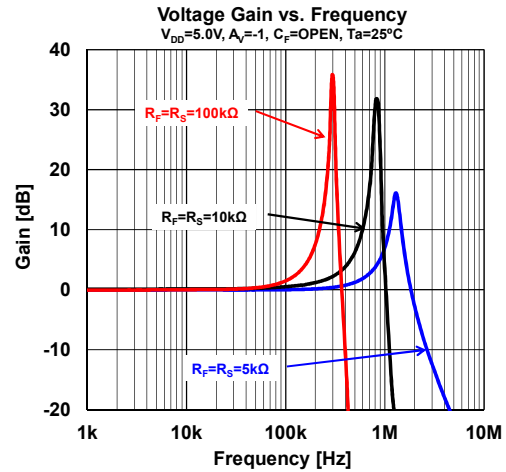

Figure5. Frequency response for difference value of R_F and R_S .

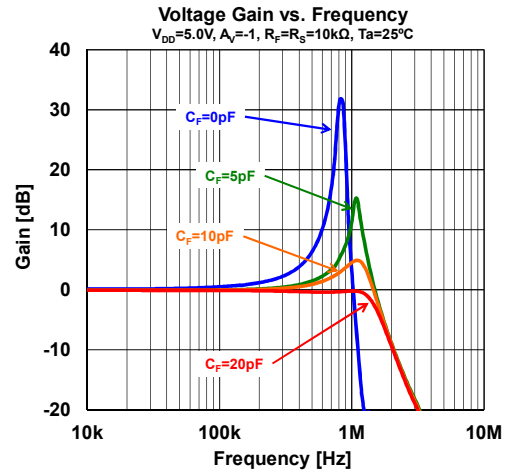

Figure6. Frequency response for difference value of C_F .

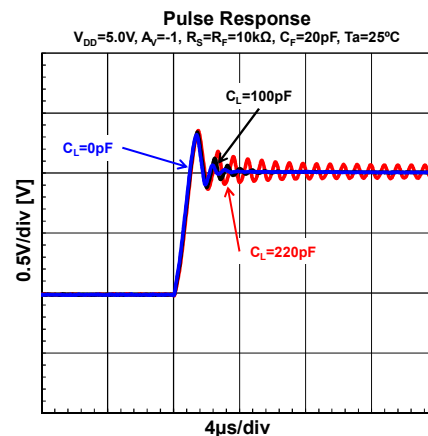

Figure7. Frequency response for difference value of C_L .

■ APPLICATION NOTE

■ Capacitive load

The unity gain follower is the most sensitive configuration to capacitive loading. The combination of capacitive load placed directly on the output of an amplifier along with the output impedance of the amplifier creates a phase lag which in turn reduces the phase margin of the amplifier. If phase margin is significantly reduced, the response will be either underdamped or the amplifier will oscillate.

Since NJU77806 has large CMOS input stage to obtain the low input voltage noise, it can directly drive capacitive loads of up to 33pF without oscillating at unity gain follower. So NJU77806 recommend a gain of 5 (14dB).

To use unity gain follower or drive heavier capacitive loads, an isolation resistor, R_{ISO} as shown Figure8, should be used. This resistor and capacitive load, C_L form a pole and hence delay the phase lag or increase the phase margin of the overall system. The larger the value of R_{ISO} , the more stable the output voltage will be. However, larger values of R_{ISO} result in reduced output swing and reduced output current drive.

The typical isolation resistor is 330Ω. Figure9 shows the pulse response with 330Ω R_{ISO} , and Figure10 shows R_{ISO} values at unity gain follower without oscillating.

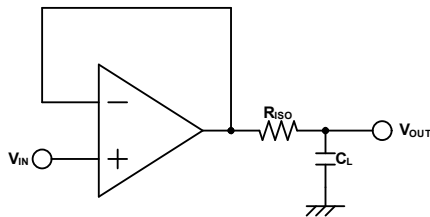

Figure8. Isolating capacitive load

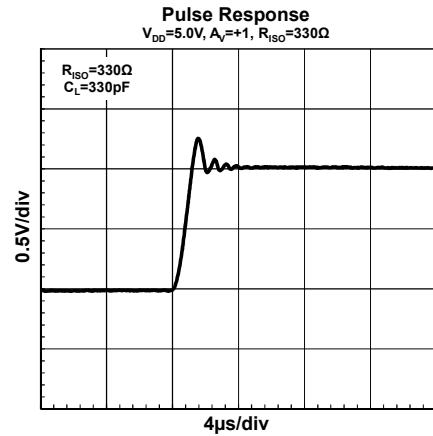

Figure9. Frequency response with 330Ω R_{ISO}

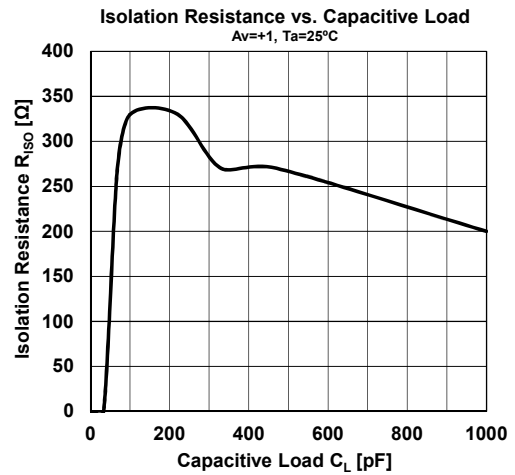
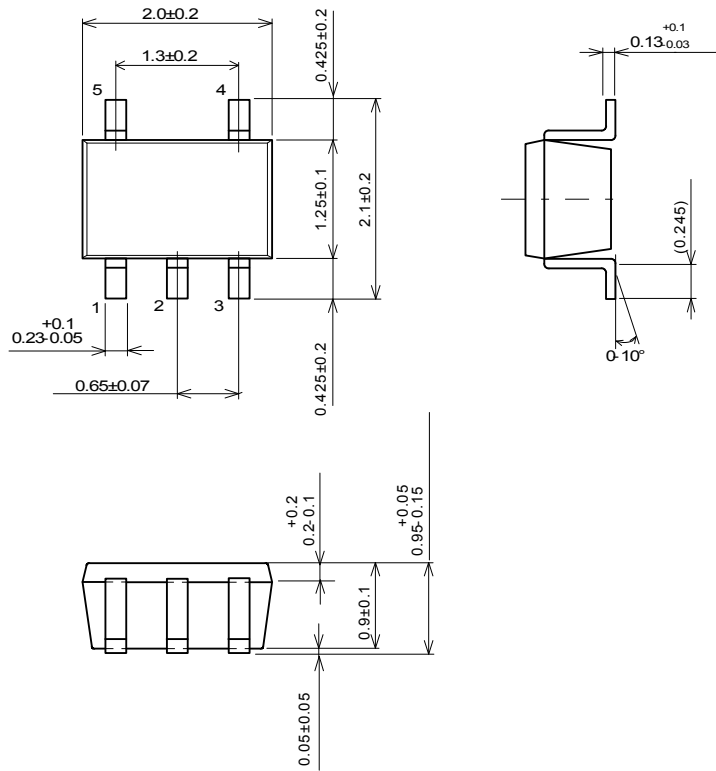

Figure10. Isolation resistance to improve stability

■ PACKAGE DIMENSIONS



Unit: mm

SC88A Package

[CAUTION]
 The specifications on this databook are only given for information, without any guarantee as regards either mistakes or omissions. The application circuits in this databook are described only to show representative usages of the product and not intended for the guarantee or permission of any right including the industrial rights.

Mouser Electronics

Authorized Distributor

Click to View Pricing, Inventory, Delivery & Lifecycle Information:

[NJR:](#)

[NJU77806F3-TE1](#)



Компания «ЭлектроПласт» предлагает заключение долгосрочных отношений при поставках импортных электронных компонентов на взаимовыгодных условиях!

Наши преимущества:

- Оперативные поставки широкого спектра электронных компонентов отечественного и импортного производства напрямую от производителей и с крупнейших мировых складов;
- Поставка более 17-ти миллионов наименований электронных компонентов;
- Поставка сложных, дефицитных, либо снятых с производства позиций;
- Оперативные сроки поставки под заказ (от 5 рабочих дней);
- Экспресс доставка в любую точку России;
- Техническая поддержка проекта, помощь в подборе аналогов, поставка прототипов;
- Система менеджмента качества сертифицирована по Международному стандарту ISO 9001;
- Лицензия ФСБ на осуществление работ с использованием сведений, составляющих государственную тайну;
- Поставка специализированных компонентов (Xilinx, Altera, Analog Devices, Intersil, Interpoint, Microsemi, Aeroflex, Peregrine, Syfer, Eurofarad, Texas Instrument, Miteq, Cobham, E2V, MA-COM, Hittite, Mini-Circuits, General Dynamics и др.);

Помимо этого, одним из направлений компании «ЭлектроПласт» является направление «Источники питания». Мы предлагаем Вам помощь Конструкторского отдела:

- Подбор оптимального решения, техническое обоснование при выборе компонента;
- Подбор аналогов;
- Консультации по применению компонента;
- Поставка образцов и прототипов;
- Техническая поддержка проекта;
- Защита от снятия компонента с производства.



Как с нами связаться

Телефон: 8 (812) 309 58 32 (многоканальный)

Факс: 8 (812) 320-02-42

Электронная почта: org@eplast1.ru

Адрес: 198099, г. Санкт-Петербург, ул. Калинина, дом 2, корпус 4, литера А.