

General Specifications

B Electrical Capacity (Resistive Load)

Power Level (silver): 6A @ 125V AC & 3A @ 250V AC
4A @ 30V DC for On-None-On; 3A @ 30V DC for all other circuits

Logic Level (gold): 0.4VA maximum @ 28V AC/DC maximum
(Applicable Range 0.1mA ~ 0.1A @ 20mV ~ 28V)

Logic/Power Level (gold over silver): Combines silver & gold ratings
Note: Find additional explanation of dual rating & operating range in Supplement section.

Other Ratings

Contact Resistance: 10 milliohms maximum for silver; 20 milliohms maximum for gold

Insulation Resistance: 1,000 megohms minimum @ 500V DC

Dielectric Strength: 1,000V AC minimum between contacts for 1 minute minimum;
1,500V AC minimum between contacts and case for 1 minute minimum

Mechanical Life: 50,000 operations minimum

Electrical Life: 25,000 operations minimum for silver; 50,000 operations minimum for gold;
50,000 operations minimum for silver at 3A @ 125V AC

Angle of Throw: 25°

Materials & Finishes

Actuator Clip & Mounting Frame: Stainless Steel

Body Frame: Stainless steel

Case: Diallyl phthalate resin (UL94V-0)

Movable Contactor: Phosphor bronze with silver or gold plating

Movable Contacts: Silver alloy (code W); copper with gold plating (code G); or silver alloy with gold plating (code A)

Stationary Contacts: Silver with silver plating (code W); copper or brass with gold plating (code G);
or silver with gold plating (code A)

Terminals: Copper or brass with silver plating; or copper or brass with gold plating

Environmental Data

Operating Temp Range: -30°C through +85°C (-22°F through +185°F)

Humidity: 90 ~ 95% humidity for 96 hours @ 40°C (104°F)

Vibration: 10 ~ 55Hz with peak-to-peak amplitude of 1.5mm traversing the frequency range & returning
in 1 minute; 3 right angled directions for 2 hours

Shock: 50G (490m/s²) acceleration (tested in 6 right angled directions, with 5 shocks in each direction)

Processing

Soldering: Wave Soldering (PC version) for Gold: See Profile A in Supplement section.

Manual Soldering for Gold: See Profile A in Supplement section.

Wave Soldering (PC version) for Silver: See Profile B in Supplement section.

Manual Soldering for Silver: See Profile B in Supplement section.

Note: Actuator must be in OFF (center) position while soldering.

Cleaning: These devices are not process sealed. Hand clean locally using alcohol based solution.

Standards & Certifications

Flammability Standards: UL94V-0 for case

UL: File No. E44145 - Recognized only when ordered with marking on switch.

Add "/U" before first dash in part number to order UL recognized switch.

All models recognized at 6A @ 125V AC, 3A @ 250V AC or 0.4VA maximum @ 28V DC maximum.

CSA: File No. 023535_0_000 - Certified only when ordered with marking on switch.

Add "/C" before first dash in part number to order CSA certified switch.

All models certified at 6A @ 125V AC or 3A @ 250V AC or 0.4VA maximum @ 28V maximum.

Distinctive Characteristics

Three methods of panel mounting: flat frame for flush with face or subpanel, snap-in, and PCB.

High insulating barriers increase isolation of circuits in multipole devices and provide added protection to contact points.

The molded diallyl phthalate case has a UL 94V-0 flammability rating.

Epoxy sealed terminals prevent entry of solder flux and other contaminants.

Prominent external insulating barriers increase insulation resistance and dielectric strength.

Bias guard prevents misalignment of contacts; interlocking of actuator block with rocker and internal guide does not allow transmission of diagonal force on rocker to reach contact mechanism.

Clinching of the frame to the case well above the base and terminals provides 1,500V dielectric strength.



Actual Size



- Toggle
- B** Rockers
- Pushbuttons
- Illuminated PB
- Programmable
- Keylocks
- Rotaries
- Slides
- Tactiles
- Tilt
- Touch
- Indicators
- Accessories
- Supplement

TYPICAL SWITCH



DESCRIPTION FOR TYPICAL ORDERING EXAMPLE

M2012TJW01-FC-1A



ORDERING EXAMPLE



IMPORTANT:



Switches are supplied without UL & CSA marking unless specified. **UL & CSA recognized only when ordered with marking on the switch.** Specific models, ratings, & ordering instructions are noted on General Specifications page.

DESCRIPTION FOR TYPICAL ORDERING EXAMPLE

M2012TJW01-FC-3A-CF



Toggles

Rockers **B**

Pushbuttons

Programmable Illuminated PB

Keylocks

Rotaries

Slides

Tactiles

Tilt

Touch

Indicators

Accessories

Supplement

POLES & CIRCUITS

		Rocker Position () = Momentary			Connected Terminals			Throw & Schematics
Pole	Model	Down	Center	Up	Down	Center	Up	
SP	M2012 M2013 M2015 M2018 M2019	ON ON ON (ON) ON	NONE OFF NONE OFF OFF	ON ON (ON) (ON) (ON)	2-3	OPEN	2-1	SPDT
DP	M2022 M2023 M2025 M2028 M2029	ON ON ON (ON) ON	NONE OFF NONE OFF OFF	ON ON (ON) (ON) (ON)	2-3 5-6	OPEN	2-1 5-4	DPDT

For 3 Throw (3-On)

		Connected Terminals & Schematic			External Connection
Pole	Model	Down	Center	Up	
SP	M2024 M2026 M2027	ON (ON) ON	ON ON ON	ON (ON) (ON)	<p>The SP3T model utilizes a double pole base.</p> <p>External connection must be made during field installation.</p>

MOUNTING FRAME

TJ

Snap-in Frame



Panel Cutout for Single Pole without Bezel



Panel Cutout for Double Pole without Bezel



Panel Thickness without Bezel: .039" ~ .126" (1.0mm ~ 3.2mm)

Panel Thickness with Bezel: .039" ~ .098" (1.0mm ~ 2.5mm)

CONTACT MATERIALS & RATINGS

W

Silver over Silver

Power Level

6A @ 125V AC & 3A @ 250V AC

G

Gold over Brass or Copper

Logic Level

0.4VA maximum @ 28V AC/DC maximum

Note: See Supplement section to find complete explanation of operating range.

A

Gold over Silver

Power Level
or Logic Level

6A @ 125V AC
or 0.4VA maximum @ 28V AC/DC maximum

Note: This dual rated option is suitable when two or more identical switches are used in logic and in power circuits within the same application. See Supplement section to find complete explanation of dual rating and operating range.

TERMINALS

01 Solder Lug



02 .062" (1.57mm) Wide Quick Connect



03 .250" (6.35mm) Straight PC



Single Pole



Double Pole

05 .425" (10.8mm) Wirewrap or Extended PC

06 .750" (19.05mm) Wirewrap or Extended PC

07 .964" (24.5mm) Wirewrap or Extended PC

08 1.062" (27.0mm) Wirewrap or Extended PC



If using as extended PC terminal, refer to the above footprints.

Dimension A = terminal lengths as shown beside the terminal codes at the left.

ROCKERS & PADDLES

F AT4150
.450" (11.43mm)
Wide Rocker

Material: Polyamide
Finish: Matte

Colors Available:
A, B, C, E, F, G, H



G AT4151
.450" (11.43mm)
Wide Paddle

Material: Polyamide
Finish: Matte

Colors Available:
A, B, C, E, F, G, H



S AT466 .453" (11.5mm)
False Illuminated Rocker

	Rocker	False Illuminator
Material:	Polycarbonate	Acrylonitrile Butadiene Styrene
Finish:	Glossy	
Colors:	Black	White and Red



When a bezel is selected with AT466, glossy polycarbonate AT207 is supplied.

Cap Colors Available:

A

Black

B

White

C

Red

E

Yellow

F

Green

G

Blue

H

Gray

OPTIONAL SNAP-IN BEZELS & BEZEL COLORS

1 AT2107 Bezel

Material: Polyamide

Finish: Matte



A Black

B White

E Yellow

F Green

G Blue

H Gray

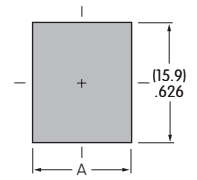

	Single Pole	Double Pole
A	(12.5)mm .492"	(13.1)mm .516"

2 AT208 Bezel for AT070 LED

Material: Polycarbonate

Finish: Glossy

Contact factory for matte finish.



A Black

LED colors & specifications on next page.

	Single Pole	Double Pole
A	(12.5)mm .492"	(13.1)mm .516"
B	(6.25)mm .246"	(6.55)mm .258"

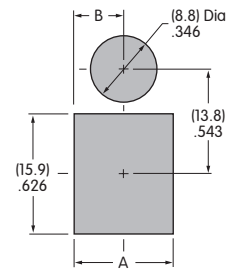

3 AT212 Bezel for AT617 LED

Material: Polycarbonate

Finish: Semi-glossy



A Black

LED colors & specifications on next page.

	Single Pole	Double Pole
A	(18.4)mm .724"	(18.7)mm .736"

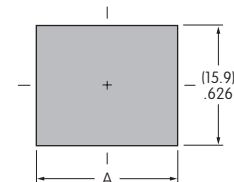

4 AT213 Bezel for AT618 LED

Material: Polycarbonate

Finish: Semi-glossy



A Black

LED colors & specifications on next page.

	Single Pole	Double Pole
A	(18.4)mm .724"	(18.7)mm .736"

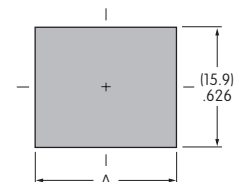

Bezel Assembly

1. Pry out tab on bezel to a 45° angle.



2. Insert switch frame under tab and snap on bezel.



3. Push tab back into place.



4. Snap assembled bezel and switch into panel.

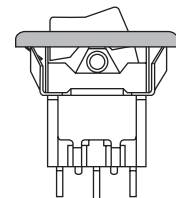

LED COLORS & SPECIFICATIONS

Bezel Orientation on Switch

AT070 LED
For Bezel AT208
with 1 LED



AT617 LED
For Bezel AT212
with 2 Round LEDs



AT618 LED
For Bezel AT213
with 2 Rectangular LEDs



Note: Lead lengths may differ from manufacturing lot to lot. The longer lead is the anode (+).

	Color	AT070		AT617			AT618		
		C	F	C	E	F	C	E	F
		Red	Green	Red	Yellow	Green	Red	Yellow	Green
Forward Peak Current	I_{FM}	25mA	50mA	30mA	30mA	25mA	10mA	30mA	30mA
Typical Forward Current	I_F	20mA	30mA	20mA	20mA	20mA	8mA	24mA	24mA
Forward Voltage	V_F	2.8V	2.1V	2.0V	2.1V	2.2V	1.9V	2.0V	2.1V
Reverse Peak Voltage	V_{RM}	4V	5V	5V	5V	5V	5V	5V	5V
Current Reduction Rate Above 25°C	ΔI_F	0.33 mA/°C	0.40 mA/°C	0.40 mA/°C	0.40 mA/°C	0.33 mA/°C	0.13 mA/°C	0.40 mA/°C	0.40 mA/°C
Ambient Temperature Range (when used with a bezel)		-10° ~ +70°C		-15° ~ +70°C			-15° ~ +70°C		

The electrical specifications shown are determined at a basic temperature of 25°C.
LED circuit is independent of switch operation. LED is colored in OFF state.

If the source voltage is greater than the rated voltage of the LED, a ballast resistor must be connected in series with the lamp.
The ballast resistor calculation and more lamp detail are shown in the Supplement section.

LEGENDS

NKK Switches can provide custom legends for caps. Contact factory for more information.

Suggested Printable Area for Cap

Recommended Print Method:

Pad Print

Epoxy based ink is recommended.



AT4150



Shaded areas are printable areas.

TYPICAL SWITCH DIMENSIONS

Snap-in Frame • Solder Lug

Single Pole



M2012TJW01-FC



Snap-in Frame • Solder Lug

Double Pole

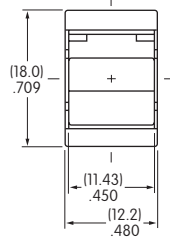

M2022TJW01-FC

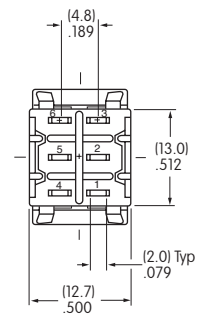
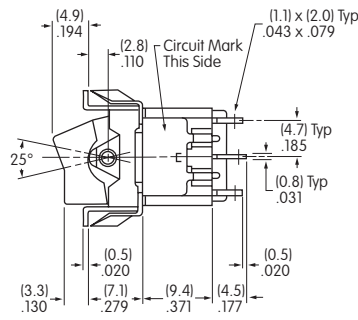

Snap-in Frame • Solder Lug

Single Pole



M2012TJW01-GC

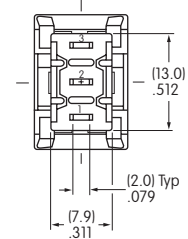
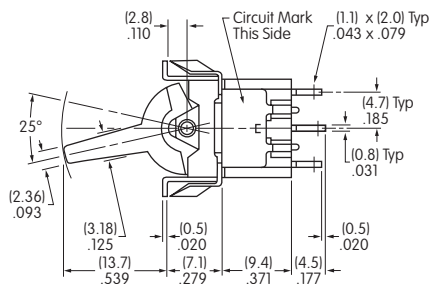

Snap-in Frame • Solder Lug

Double Pole



M2022TJW01-GC

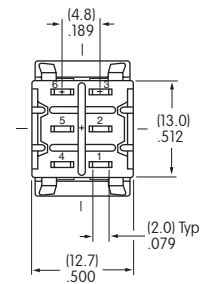
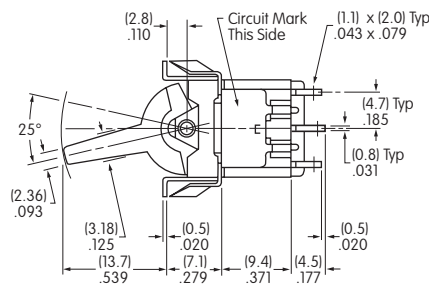

TYPICAL SWITCH DIMENSIONS

Single & Double Pole

Snap-in Frame • AT2107 Bezel • Solder Lug



M2012JW01-FC-1A

Double Pole

Snap-in Frame • AT208 Bezel • Solder Lug



M2022JW01-FC-2A-C

Single Pole

Snap-in Frame • AT212 Bezel • Solder Lug



M2012JW01-FC-3A-CF

Double Pole

Snap-in Frame • AT213 Bezel • Solder Lug



M2022JW01-FC-4A-CF



Компания «ЭлектроПласт» предлагает заключение долгосрочных отношений при поставках импортных электронных компонентов на взаимовыгодных условиях!

Наши преимущества:

- Оперативные поставки широкого спектра электронных компонентов отечественного и импортного производства напрямую от производителей и с крупнейших мировых складов;
- Поставка более 17-ти миллионов наименований электронных компонентов;
- Поставка сложных, дефицитных, либо снятых с производства позиций;
- Оперативные сроки поставки под заказ (от 5 рабочих дней);
- Экспресс доставка в любую точку России;
- Техническая поддержка проекта, помощь в подборе аналогов, поставка прототипов;
- Система менеджмента качества сертифицирована по Международному стандарту ISO 9001;
- Лицензия ФСБ на осуществление работ с использованием сведений, составляющих государственную тайну;
- Поставка специализированных компонентов (Xilinx, Altera, Analog Devices, Intersil, Interpoint, Microsemi, Aeroflex, Peregrine, Syfer, Eurofarad, Texas Instrument, Miteq, Cobham, E2V, MA-COM, Hittite, Mini-Circuits, General Dynamics и др.);

Помимо этого, одним из направлений компании «ЭлектроПласт» является направление «Источники питания». Мы предлагаем Вам помощь Конструкторского отдела:

- Подбор оптимального решения, техническое обоснование при выборе компонента;
- Подбор аналогов;
- Консультации по применению компонента;
- Поставка образцов и прототипов;
- Техническая поддержка проекта;
- Защита от снятия компонента с производства.



Как с нами связаться

Телефон: 8 (812) 309 58 32 (многоканальный)

Факс: 8 (812) 320-02-42

Электронная почта: org@eplast1.ru

Адрес: 198099, г. Санкт-Петербург, ул. Калинина, дом 2, корпус 4, литера А.