

Plug-In Outlet Center[®] Units

Wiremold[®] Plug-In Outlet Center Units bring power safely and conveniently to wherever you need it. These units are ideal for use in a wide variety of settings, including relay racks and cabinets, laboratories, workshops, classrooms and offices.

Plug-In Outlet Center Units include rack mount, Cabinet-MATE, compact, 90 degree, deluxe control, industrial, and international units. Most units are available in both 15 and 20 Amp configurations.

Wiremold also offers extensive custom capabilities for Plug-In Outlet Center Units. Contact the factory for more information.

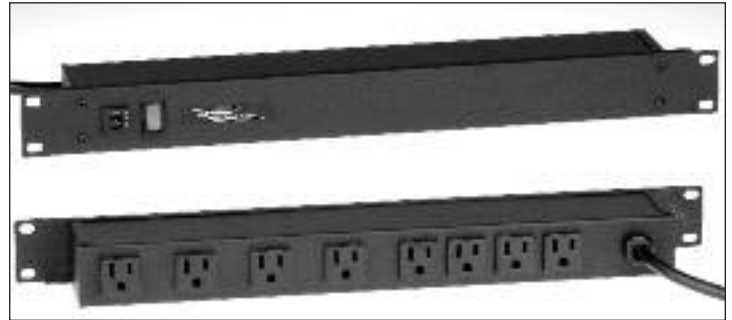

J08B0B (Front & Back)



UL207BC



J06B0B20X-AM (Front)











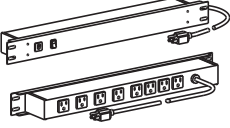

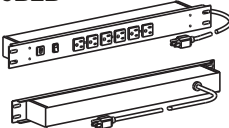

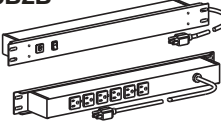
P6

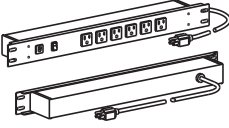

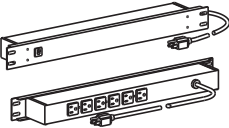

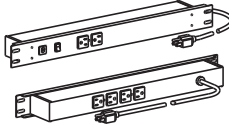



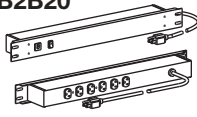

FEATURES & BENEFITS

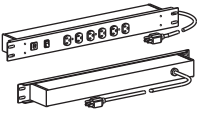
- **User-ready outlets.** Plug-In Outlet Center units provide power distribution in a portable, plug-in unit.
- **Rugged construction.** Durable 2" x 1 3/4" [44mm x 51mm] or 3 1/2" x 2" [89mm x 44mm] aluminum housing. Some Plug-In Outlet Center units are available with an impact-resistant plastic housing.
- **Space saving.** Rack mount units fit standard 19" [482mm] relay racks. Compact 1U design takes up minimum space. 23" [584mm] units available, consult factory.
- **Low profile.** CabinetMATE units offer a narrow 1 1/2" x 1 3/16" [38mm x 20mm] aluminum housing.
- **Aesthetically pleasing.** Rack mount units have a black matte finish and a black cord. CabinetMATE, compact and industrial units have a gray finish and a black cord. Deluxe control and 20A units have a putty white finish and a black cord. Most units with a putty white finish have a putty white cord. Special Use units have a white finish and a white cord.
- **Flexible mounting.** Each unit features one of four different mounting types. Each mounting method has been designed to optimize the performance of the product. Complete mounting hardware and installation instructions are included with every unit.
- **Cord properly rated to load requirements.** 15A units have a 14/3 SJT cord and a NEMA 5-15P plug. 20A units have a 12/3 SJT cord and a NEMA 5-20P or NEMA L5-20P plug.
- **Lighted switch.** Most units have lighted on/off switch(es) to control power to the unit.
- **Resettable circuit breaker.** Provides overload protection.
- **Two-Year product warranty.**
- **UL and cUL Listed or Recognized.** Units are UL and cUL Listed to UL1363 standards. Rack mount units are UL and cUL Recognized to UL1363 standards.

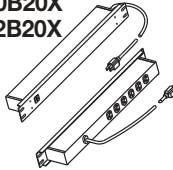
15A Rack Mount Plug-In Outlet Centers Ordering Information

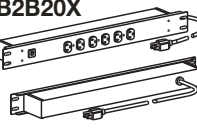
Catalog No./Item	Description/Specifications	Catalog No./Item	Description/Specifications
J08B0B J08B2B 	Rack Mount Plug-In Outlet Center – Eight rear outlets, lighted switch. Receptacles rotated 90° and 4 outlets spaced to accommodate transformers. 6' [1.8m] (J08B0B) or 15' [4.6m] (J08B2B) cord. Receptacle center-to-center 1 1/2" [38mm] and 2" [51mm]. 	J60B0B J60B2B 	Rack Mount Plug-In Outlet Center – Six front outlets, lighted switch. 6' [1.8m] (J60B0B) or 15' [4.6m] (J60B2B) cord. Receptacle center-to-center 1 1/2" [38mm]. 
J06B0B J06B2B 	Rack Mount Plug-In Outlet Center – Six rear outlets, lighted switch. 6' [1.8m] (J06B0B) or 15' [4.6m] (J06B2B) cord. Receptacle center-to-center 1 1/2" [38mm]. 	J60B0B-90 J60B2B-90 	Rack Mount Plug-In Outlet Center – Six front outlets, lighted switch. Receptacles rotated 90°. 6' [1.8m] (J60B0B-90) or 15' [4.6m] (J60B2B-90) cord. Receptacle center-to-center 1 1/2" [38mm]. 
J06B0BX J06B2BX 	Rack Mount Plug-In Outlet Center – Six rear outlets. 6' [1.8m] (J06B0BX) or 15' [4.6m] (J06B2B) cord. Receptacle center-to-center 1 1/2" [38mm]. 	J24B0B J24B2B 	Rack Mount Plug-In Outlet Center – Two front, four rear outlets. Lighted switch. 6' [1.8m] (J24B0B) or 15' [4.6m] (J24B2B) cord. Receptacle center-to-center 1 1/2" [38mm]. 

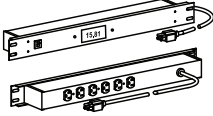
20A Rack Mount Plug-In Outlet Centers Ordering Information

Catalog No./Item	Description/Specifications	Catalog No./Item	Description/Specifications
J06B0B20 J06B2B20 	Rack Mount Plug-In Outlet Center – Six 20A rear outlets, on/off switch. 6' [1.8m] (J06B0B20) or 15' [4.6m] (J06B2B20) cord. Receptacle center-to-center 1 1/2" [38mm]. 	J60B0B20 J60B2B20 	Rack Mount Plug-In Outlet Center – Six 20A front outlets, on/off switch. 6' [1.8m] (J60B0B20) or 15' [4.6m] (J60B2B20) cord. Receptacle center-to-center 1 1/2" [38mm]. 
J06B0B20X J06B2B20X 	Rack Mount Plug-In Outlet Center – Six 20A rear outlets. 6' [1.8m] (J06B0B20X) or 15' [4.6m] (J06B2B20X) cord. Receptacle center-to-center 1 1/2" [38mm]. 	J60B0B20X J60B2B20X 	Rack Mount Plug-In Outlet Center – Six 20A front outlets. 6' [1.8m] (J60B0B20X) or 15' [4.6m] (J60B2B20X) cord. Receptacle center-to-center 1 1/2" [38mm]. 
J06B0B20X-AM 	Rack Mount Plug-In Outlet Center with Digital Ammeter – Digital LCD readout of current draw. Six 20A rear outlets. 6' [1.8m] cord. Receptacle center-to-center 1 1/2" [38mm]. 		

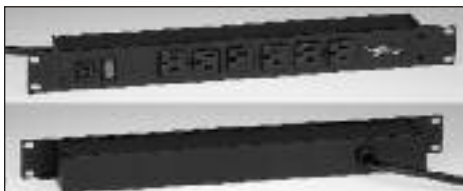

J06B0B (Front & Back)







J24B0B (Front & Back)





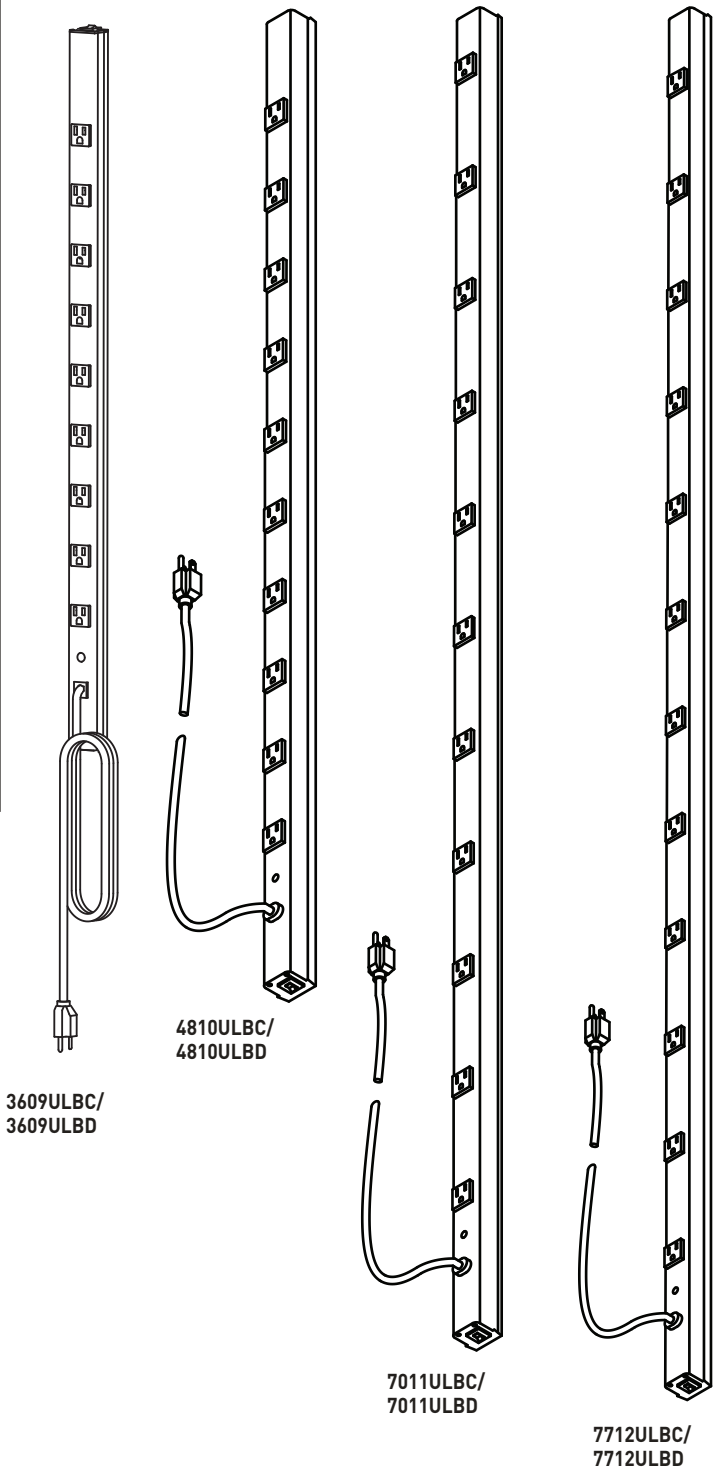

J06B0B20X (Front & Back)

15A CabinetMATE Plug-In Outlet Centers Ordering Information

Catalog No./Item	Description/Specifications
3609ULBC 3609ULBD	CabinetMATE Plug-In Outlet Center – Nine outlets. 6' [1.8m] (3609ULBC) or 15' [4.6m] (3609ULBD) cord. Length 36" [914mm]. Receptacle center-to-center 3" [76mm]. <div style="text-align: right;">  </div>
4810ULBC 4810ULBD	CabinetMATE Plug-In Outlet Center – Ten outlets. 6' [1.8m] (4810ULBC) or 15' [4.6m] (4810ULBD) cord. Length 48" [1.2m]. Receptacle center-to-center 4" [102mm]. <div style="text-align: right;">  </div>
7011ULBC 7011ULBD	CabinetMATE Plug-In Outlet Center – Eleven outlets. 6' [1.8m] (7011ULBC) or 15' [4.6m] (7011ULBD) cord. Length 70" [1.8m]. Receptacle center-to-center 6" [152mm]. <div style="text-align: right;">  </div>
7712ULBC 7712ULBD	CabinetMATE Plug-In Outlet Center – Twelve outlets. 6' [1.8m] (7712ULBC) or 15' [4.6m] (7712ULBD) cord. Length 77" [2m]. Receptacle center-to-center 6" [152mm]. <div style="text-align: right;">  </div>



20A CabinetMATE Plug-In Outlet Centers Ordering Information

Catalog No./Item	Description/Specifications
2008ULBC20R 2008ULBD20R 2008ULBC20R-TL * 2008ULBD20R-TL *	CabinetMATE Plug-In Outlet Center – Eight 20A outlets with t-slots. 6' [1.8m] (2008ULBC20R, 2008ULBC20R-TL) or 15' [4.6m] (2008ULBD20R, 2008ULBD20R-TL) cord. Length 20" [508mm]. Receptacle center-to-center 1 1/4" [32mm]. Units available with straight blade or NEMA L5-20P locking plug. <div style="text-align: right;">  </div>
4810ULBC20R 4810ULBD20R 4810ULBC20R-TL * 4810ULBD20R-TL *	CabinetMATE Plug-In Outlet Center – Ten 20A outlets with t-slots. 6' [1.8m] (4810ULBC20R, 4810ULBC20R-TL) or 15' [4.6m] (4810ULBD20R, 4810ULBD20R-TL) cord. Length 48" [1.2m]. Receptacle center-to-center 4" [102mm]. Units available with straight blade or NEMA L5-20P locking plug. <div style="text-align: right;">  </div>
7011ULBC20R 7011ULBD20R 7011ULBC20R-TL * 7011ULBD20R-TL *	CabinetMATE Plug-In Outlet Center – Eleven 20A outlets with t-slots. 6' [1.8m] (7011ULBC20R, 7011ULBC20R-TL) or 15' [4.6m] (7011ULBD20R, 7011ULBD20R-TL) cord. Length 70" [1.6m]. Receptacle center-to-center 6" [152mm]. Units available with straight blade or NEMA L5-20P locking plug. <div style="text-align: right;">  </div>
7712ULBC20R 7712ULBD20R 7712ULBC20R-TL * 7712ULBD20R-TL *	CabinetMATE Plug-In Outlet Center – Twelve 20A outlets with t-slots. 6' [1.8m] (7712ULBC20R, 7712ULBC20R-TL) or 15' [4.6m] (7712ULBD20R, 7712ULBD20R-TL) cord. Length 77" [2m]. Receptacle center-to-center 6" [152mm]. Units available with straight blade or NEMA L5-20P locking plug. <div style="text-align: right;">  </div>

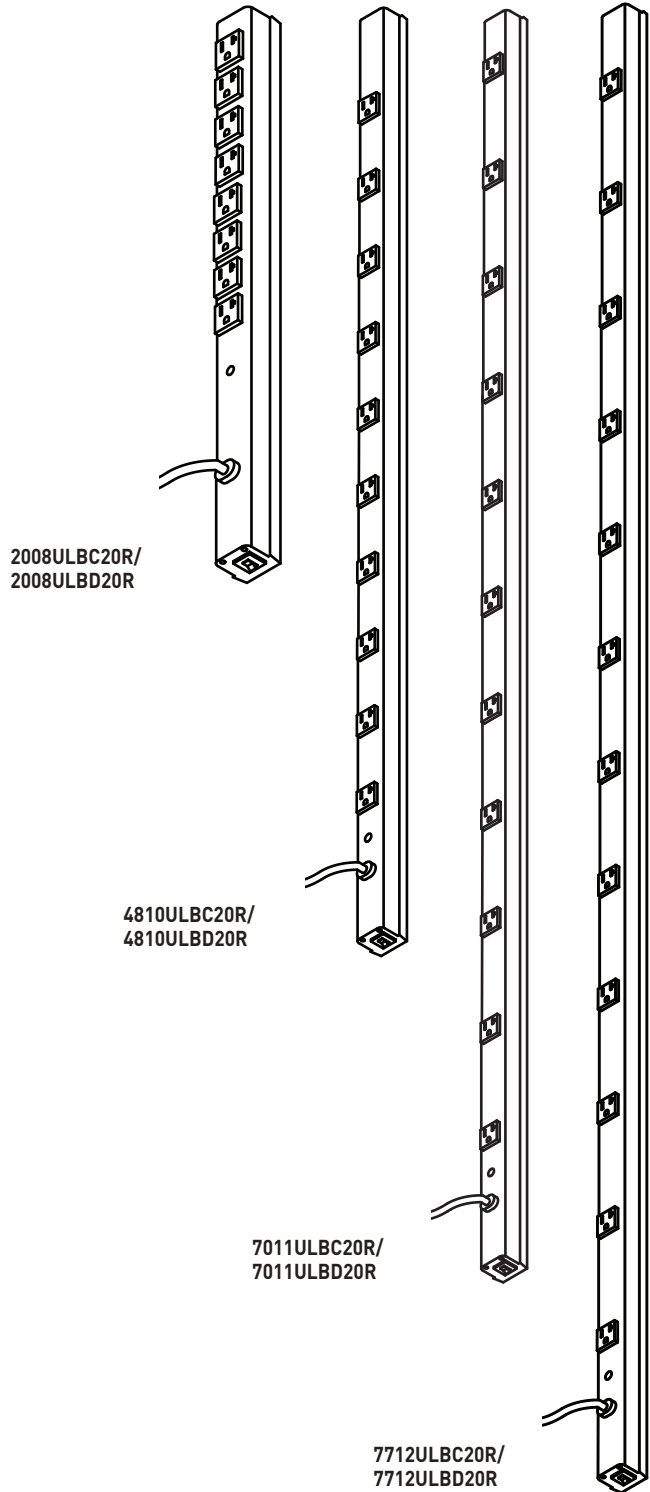









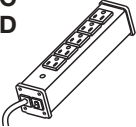

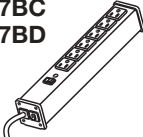

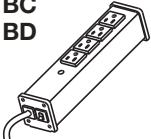

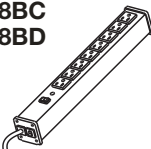

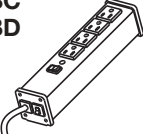

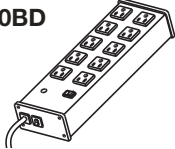

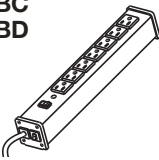

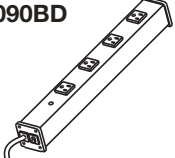

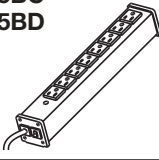
* Use "TL" suffix with Catalog Number for locking plug.

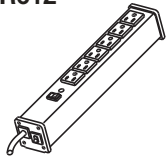

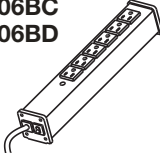

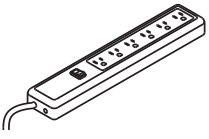



20A NEMA L5-20P Locking Plug

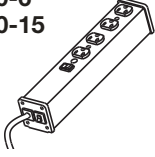

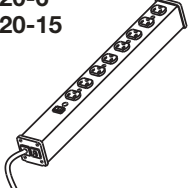

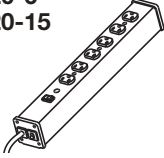









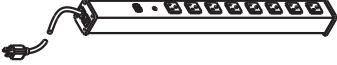

Compact Plug-In Outlet Centers Ordering Information

Catalog No./Item	Description/Specifications	Catalog No./Item	Description/Specifications
UL100BC UL100BD	 Compact Plug-In Outlet Center – Five outlets, 6' [1.8m] (UL100BC) or 15' [4.6m] (UL100BD) cord. Length 9 1/4" [235mm]. Receptacle center-to-center 1 1/4" [32mm]. 	UL207BC UL207BD	 Compact Plug-In Outlet Center – Six outlets, lighted switch. 6' [1.8m] (UL207BC) or 15' [4.6m] (UL207BD) cord. Length 12 1/4" [311mm]. Receptacle center-to-center 1 1/4" [32mm]. 
UL101BC UL101BD	 Compact Plug-In Outlet Center – Four outlets, 6' [1.8m] (UL101BC) or 15' [4.6m] (UL101BD) cord. Length 9 1/4" [235mm]. Receptacle center-to-center 1 1/4" [32mm]. 	UL218BC UL218BD	 Compact Plug-In Outlet Center – Eight outlets, lighted switch. 6' [1.8m] (UL218BC) or 15' [4.6m] (UL218BD) cord. Length 15" [381mm]. Receptacle center-to-center 1 1/4" [32mm]. 
UL104BC UL104BD	 Compact Plug-In Outlet Center – Four outlets, lighted switch. 6' [1.8m] (UL104BC) or 15' [4.6m] (UL104BD) cord. Length 9 1/4" [235mm]. Receptacle center-to-center 1 1/4" [32mm]. 	UL210BC UL210BD	 Compact Plug-In Outlet Center – Ten outlets, lighted switch. Putty white finish. 6' [1.8m] (UL210BC) or 15' [4.6m] (UL210BD) cord. Length 13" [330mm]. Width 3 1/2" [89mm]. Receptacle center-to-center 1 15/16" [49mm]. 
UL204BC UL204BD	 Compact Plug-In Outlet Center – Seven outlets, lighted switch. 6' [1.8m] (UL204BC) or 15' [4.6m] (UL204BD) cord. Length 13" [330mm]. Receptacle center-to-center 1 1/4" [32mm]. 	UL1090BC UL1090BD	 Compact Plug-In Outlet Center – Four outlets. Receptacles rotated 90° and spaced to accommodate transformers. 6' [1.8m] (UL1090BC) or 15' [4.6m] (UL1090BD) cord. Length 16" [406mm]. Receptacle center-to-center 3" [76mm]. 
UL205BC UL205BD	 Compact Plug-In Outlet Center – Eight outlets, 6' [1.8m] (UL205BC) or 15' [4.6m] (UL205BD) cord. Length 13" [330mm]. Receptacle center-to-center 1 1/4" [32mm]. 	R610/R612	 Compact Plug-In Outlet Center – Six outlets, lighted switch. Putty white finish, 6' [1.8m] (R610) or 15' [4.6m] (R612) cord. Length 12 1/4" [311mm]. Receptacle center-to-center 1 1/4" [32mm]. 
UL206BC UL206BD	 Compact Plug-In Outlet Center – Six outlets. 6' [1.8m] (UL206BC) or 15' [4.6m] (UL206BD) cord. Length 12 1/4" [311mm]. Receptacle center-to-center 1 1/4" [32mm]. 	P6/P6-15	 Compact Plug-In Outlet Center – Six outlets, lighted switch. Putty white finish, plastic housing. 6' [1.8m] or 15' [4.6m] cord. Length 12" [305mm]. Receptacle center-to-center 1 1/4" [32mm]. 



20A Plug-In Outlet Centers Ordering Information

Catalog No./Item	Description/Specifications	Catalog No./Item	Description/Specifications
ULB420-6 ULB420-15 	20A Plug-In Outlet Center – Four 20A, 120V, 60Hz 2500 watt outlets. Lighted switch, putty white finish. 6' [1.8m] (ULB420-6) or 15' [4.6m] (ULB420-15) cord. Length 10 3/4" [273mm]. Receptacle center-to-center 1 1/2" [38mm]. 	ULB820-6 ULB820-15 	20A Plug-In Outlet Center – Eight 20A, 120V, 60Hz 2500 watt outlets. Lighted switch, putty white finish. 6' [1.8m] (ULB820-6) or 15' [4.6m] (ULB820-15) cord. Length 17 1/4" [438mm]. Receptacle center-to-center 1 1/2" [38mm]. 
ULB620-6 ULB620-15 	20A Plug-In Outlet Center – Six 20A, 120V, 60Hz 2500 watt outlets. Lighted switch, putty white finish. 6' [1.8m] (ULB620-6) or 15' [4.6m] (ULB620-15) cord. Length 13 1/4" [337mm]. Receptacle center-to-center 1 1/2" [38mm]. 		

Industrial Plug-In Outlet Centers Ordering Information

Catalog No./Item	Description/Specifications	Catalog No./Item	Description/Specifications
UL309BC UL309BD 	Industrial Plug-In Outlet Center – Nine outlets, lighted switch, 6' [1.8m] (UL309BC) or 15' [4.6m] (UL309BD) cord. Length 36" [915mm]. Receptacle center-to-center 3" [76mm]. 	UL403BC UL403BD 	Industrial Plug-In Outlet Center – Eight outlets, 6' [1.8m] (UL403BC) or 15' [4.6m] (UL403BD) cord. Length 48" [1220mm]. Receptacle center-to-center 5 1/4" [133mm]. 
UL300BC UL300BD 	Industrial Plug-In Outlet Center – Eight outlets, lighted switch. 6' [1.8m] (UL300BC) or 15' [4.6m] (UL300BD) cord. Length 24" [609mm]. Receptacle center-to-center 2" [51mm]. 	UL404BC UL404BD 	Industrial Plug-In Outlet Center – Sixteen outlets, 6' [1.8m] (UL404BC) or 15' [4.6m] (UL404BD) cord. Length 48" [1220mm]. Receptacle center-to-center 2 1/2" [64mm]. 
UL401BC UL401BD 	Industrial Plug-In Outlet Center – Eight outlets, lighted switch. 6' [1.8m] (UL401BC) or 15' [4.6m] (UL401BD) cord. Length 48" [1220mm]. Receptacle center-to-center 5 1/4" [133mm]. 	UL2062BC UL2062BD 	Industrial Plug-In Outlet Center – Twelve outlets, 6' [1.8m] (UL2062BC) or 15' [4.6m] (UL2062BD) cord. Length 72" [1830mm]. Receptacle center-to-center 5 1/4" [133mm]. 
UL402BC UL402BD 	Industrial Plug-In Outlet Center – Sixteen outlets, lighted switch. 6' [1.8m] (UL402BC) or 15' [4.6m] (UL4032BD) cord. Length 48" [1220mm]. Receptacle center-to-center 2 1/2" [64mm]. 	UL2063BC UL2063BD 	Industrial Plug-In Outlet Center – Twenty-four outlets, 6' [1.8m] (UL2063BC) or 15' [4.6m] (UL2063BD) cord. Length 72" [1830mm]. Receptacle center-to-center 2 1/2" [64mm]. 

Industrial Plug-In Outlet Centers Ordering Information

Catalog No./Item	Description/Specifications	Catalog No./Item	Description/Specifications
UL2064BC UL2064BD	Industrial Plug-In Outlet Center – Twelve outlets, lighted switch. 6' [1.8m] (UL2064BC) or 15' [4.6m] (UL2064BD) cord. Length 72" [1830mm]. Receptacle center-to- center 5 1/4" [133mm].	UL2065BC UL2065BD	Industrial Plug-In Outlet Center – Twenty-four outlets, lighted switch. 6' [1.8m] (UL2065BC) or 15' [4.6m] (UL2065BD) cord. Length 72" [1830mm]. Receptacle center-to- center 2 1/2" [64mm].
			

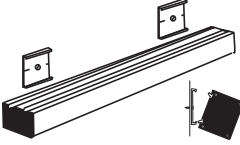
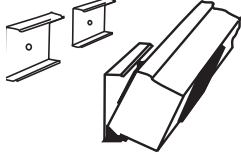
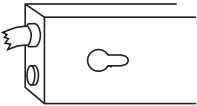
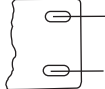

Mounting Types

Catalog No./Item	Description/Specifications	Catalog No./Item	Description/Specifications
Snap-on/Slide-off	Mounting Bracket – Mount unit in any position. Includes two aluminum mounting clips that snap onto mounting rails on the back of the unit. Screws also included. Used for all units with 2" [51mm] housing. NOTE: For UL units.	Spring Clip Mounting	Spring Clip Mounting Bracket – Mount unit in any position. Includes two spring steel mounting clips that snap onto the unit. Screws also included. Used for all units with 1 1/2" [38mm] narrow aluminum housing. NOTE: For CabinetMate units.
Keyhole Mounting	Keyhole Mounting Bracket – Mount unit in almost any position. Screws not included. Available on all plastic units and units with 3 1/2" [89mm] aluminum housing.	Rack Mounting	Rack Mounting Bracket – Fits standard 19" [482mm] rack. Screws not included.
			
			

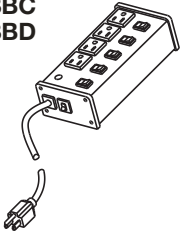
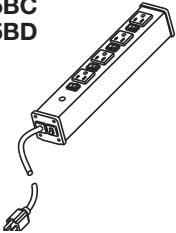
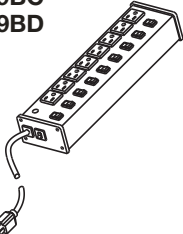

Deluxe Control Plug-In Outlet Centers Ordering Information

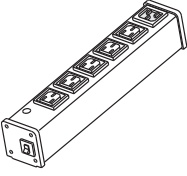
Catalog No./Item	Description/Specifications	Catalog No./Item	Description/Specifications
UL208BC UL208BD	Deluxe Control Plug-In Outlet Center – Four individually switched outlets. Lighted on/off switch. Putty white finish. 6' [1.8m] (UL208BC) or 15' [4.6m] (UL208BD) cord. Length 7 1/2" [191mm]. Width 3 1/2" [89mm]. Receptacle center-to-center 1 15/16" [33mm].	UL215BC UL215BD	Deluxe Control Plug-In Outlet Center – Four individually switched outlets. Lighted on/off switch. Gray finish. 6' [1.8m] (UL215BC) or 15' [4.6m] (UL215BD) cord. Length 13" [330mm]. Width 2" [51mm]. Receptacle center-to-center 2 1/8" [54mm].
			
UL209BC UL209BD	Deluxe Control Plug-In Outlet Center – Eight individually switched outlets. Lighted on/off switch. Putty white finish. 6' [1.8m] (UL209BC) or 15' [4.6m] (UL209BD) cord. Length 13" [330mm]. Width 3 1/2" [89mm]. Receptacle center-to-center 1 15/16" [33mm].		
			





International Plug-In Outlet Center Ordering Information

Catalog No./Item	Description/Specifications
IEC5	<p>International Plug-In Outlet Center – Five 250V, IEC 320 outlets. Gray finish. 10A single pole circuit breaker. Power cord not included. Length 11" [279mm]. Receptacle center-to-center 1 1/2" [38mm]. TÜV and UL1950 Information Technology Listed.</p>  

Steel Cord-Ended Plugmold Ordering Information

Catalog No./Item	Description/Specifications
V20-C2 G20-C2	<p>Steel Cord-Ended Plugmold – Six outlets, ivory or gray finish. 6' [1.8m] cord. Length 40" [1m]. Receptacle center-to-center 6" [152mm].</p>  

Nonmetallic Cord-Ended Plugmold Ordering Information

Catalog No./Item	Description/Specifications
NM20-C3	<p>Nonmetallic Cord-Ended Plugmold – Six (3 duplex) outlets, ivory finish. 6' [1.8m] cord. Length 36" [915mm]. Receptacle center-to-center 12" [305mm].</p>  
NM20-C4	<p>Nonmetallic Cord-Ended Plugmold – Eight (4 duplex) outlets, ivory finish. 6' [1.8m] cord. Length 48" [1.2m]. Receptacle center-to-center 12" [305mm].</p>  

Questions? Call Technical Support today at 1-800-SENTREX.



60 Woodlawn Street
West Hartford, CT 06110
Phone: 1.877.BY.LEGRAND (295-3472)
www.legrand.us/wiremold
570 Applewood Crescent
Vaughan, Ontario L4K 4B4
Phone: 905.738.9195





Компания «ЭлектроПласт» предлагает заключение долгосрочных отношений при поставках импортных электронных компонентов на взаимовыгодных условиях!

Наши преимущества:

- Оперативные поставки широкого спектра электронных компонентов отечественного и импортного производства напрямую от производителей и с крупнейших мировых складов;
- Поставка более 17-ти миллионов наименований электронных компонентов;
- Поставка сложных, дефицитных, либо снятых с производства позиций;
- Оперативные сроки поставки под заказ (от 5 рабочих дней);
- Экспресс доставка в любую точку России;
- Техническая поддержка проекта, помощь в подборе аналогов, поставка прототипов;
- Система менеджмента качества сертифицирована по Международному стандарту ISO 9001;
- Лицензия ФСБ на осуществление работ с использованием сведений, составляющих государственную тайну;
- Поставка специализированных компонентов (Xilinx, Altera, Analog Devices, Intersil, Interpoint, Microsemi, Aeroflex, Peregrine, Syfer, Eurofarad, Texas Instrument, Miteq, Cobham, E2V, MA-COM, Hittite, Mini-Circuits, General Dynamics и др.);

Помимо этого, одним из направлений компании «ЭлектроПласт» является направление «Источники питания». Мы предлагаем Вам помощь Конструкторского отдела:

- Подбор оптимального решения, техническое обоснование при выборе компонента;
- Подбор аналогов;
- Консультации по применению компонента;
- Поставка образцов и прототипов;
- Техническая поддержка проекта;
- Защита от снятия компонента с производства.



Как с нами связаться

Телефон: 8 (812) 309 58 32 (многоканальный)

Факс: 8 (812) 320-02-42

Электронная почта: org@eplast1.ru

Адрес: 198099, г. Санкт-Петербург, ул. Калинина, дом 2, корпус 4, литера А.