

Optocoupler, Phototransistor Output, High Temperature



17918-23



FEATURES

- Temperature range - 55 °C to + 110 °C
- Rated impulse voltage (transient overvoltage)
 $V_{IOTM} = 6 \text{ kV}_{peak}$
- Isolation test voltage (partial discharge test voltage)
 $V_{pd} = 1.6 \text{ kV}$
- Rated isolation voltage (RMS includes DC)
 $V_{IOWM} = 600 \text{ V}_{RMS}$
- Rated recurring peak voltage (repetitive) $V_{IORM} = 850 \text{ V}_{peak}$
- Material categorization: For definitions of compliance please see www.vishay.com/doc?99912



RoHS
COMPLIANT

DESCRIPTION

The VO615A consists of a phototransistor optically coupled to a gallium arsenide infrared-emitting diode in a 4 pin plastic dual inline package.

AGENCY APPROVALS

(All parts are certified under base model VO615A)

- BSI: EN 60065:2002, EN 60950-1:2006
- DIN EN 60747-5-5 (VDE 0884), available with option 1
- FIMKO: FI25155
- UL 1577 file no. E52744
- cUL 1577 tested to CSA 22.2 bulletin 5A
- CQC file no. 09001038077; 09001038080

APPLICATIONS

Circuits for safe protective separation against electrical shock according to safety class II (reinforced isolation):

- Application class I to IV at mains voltage $\leq 300 \text{ V}$
- Application class I to IV at mains voltage $\leq 600 \text{ V}$ according to table 1 of IEC 60664-1, suitable for:
 - Switch-mode power supplies
 - Line receiver
 - Computer peripheral interface
 - Microprocessor system interface

| ORDERING INFORMATION | | | | | | | | | | | | | | | |
|--|--------------|---------------|---------------|---------------|---------------|---------------|---------------|----------------|---------------|---------------|---------------|--|--|--|--|
| <div style="display: flex; justify-content: space-around; border: 1px solid black; padding: 5px;"> VO615A-#X0##T </div> | | | | | | | | | | | | | | | |
| PART NUMBER | | | | | | CTR BIN | | PACKAGE OPTION | | | TAPE AND REEL | | | | |
| AGENCY CERTIFIED/ PACKAGE | CTR (%) | | | | | | | | | | | | | | |
| | 5 mA | | 10 mA | | | | 5 mA | | | | | | | | |
| BSI, FIMKO, UL, cUL, CQC (option 1) | 50 to 600 | 40 to 80 | 63 to 125 | 100 to 200 | 160 to 320 | 50 to 150 | 100 to 300 | 80 to 160 | 130 to 260 | 200 to 400 | | | | | |
| DIP-4 | VO615A | VO615A-1 | VO615A-2 | VO615A-3 | VO615A-4 | VO615A-5 | VO615A-6 | VO615A-7 | VO615A-8 | VO615A-9 | | | | | |
| DIP-4, 400 mil, option 6 | VO615A-X006 | VO615A-1X006 | VO615A-2X006 | VO615A-3X006 | VO615A-4X006 | VO615A-5X006 | VO615A-6X006 | VO615A-7X006 | VO615A-8X006 | VO615A-9X006 | | | | | |
| SMD-4, option 7 | VO615A-X007T | VO615A-1X007T | VO615A-2X007T | VO615A-3X007T | VO615A-4X007T | VO615A-5X007T | VO615A-6X007T | VO615A-7X007T | VO615A-8X007T | VO615A-9X007T | | | | | |
| SMD-4, option 8 | - | - | - | VO615A-3X008T | - | - | - | - | - | - | | | | | |
| SMD-4, option 9 | VO615A-X009T | VO615A-1X009T | VO615A-2X009T | VO615A-3X009T | VO615A-4X009T | VO615A-5X009T | VO615A-6X009T | VO615A-7X009T | - | - | | | | | |
| VDE, BSI, FIMKO, UL, cUL, CQC | 50 to 600 | 40 to 80 | 63 to 125 | 100 to 200 | 160 to 320 | 50 to 150 | 100 to 300 | 80 to 160 | 130 to 260 | 200 to 400 | | | | | |
| DIP-4 | VO615A-X001 | VO615A-1X001 | VO615A-2X001 | VO615A-3X001 | VO615A-4X001 | - | VO615A-6X001 | VO615A-7X001 | VO615A-8X001 | - | | | | | |
| DIP-4, 400 mil, option 6 | - | - | VO615A-2X016 | VO615A-3X016 | VO615A-4X016 | VO615A-5X016 | - | - | VO615A-8X016 | VO615A-9X016 | | | | | |
| SMD-4, option 7 | VO615A-X017T | VO615A-1X017T | - | VO615A-3X017T | VO615A-4X017T | - | VO615A-6X017T | VO615A-7X017T | VO615A-8X017T | VO615A-9X017T | | | | | |
| SMD-4, option 8 | - | - | - | VO615A-3X018T | VO615A-4X018T | - | - | - | VO615A-8X018T | - | | | | | |
| SMD-4, option 9 | - | VO615A-1X019T | VO615A-2X019T | VO615A-3X019T | VO615A-4X019T | - | - | - | - | - | | | | | |

Note

- Additional options may be possible, please contact sales office.

| ABSOLUTE MAXIMUM RATINGS ($T_{amb} = 25\text{ }^{\circ}\text{C}$, unless otherwise specified) | | | | |
|--|--------------------------------------|------------|---------------|--------------------|
| PARAMETER | TEST CONDITION | SYMBOL | VALUE | UNIT |
| INPUT | | | | |
| Reverse voltage | | V_R | 6 | V |
| Forward current | | I_F | 60 | mA |
| Forward surge current | $t_p \leq 10\text{ }\mu\text{s}$ | I_{FSM} | 1.5 | A |
| LED power dissipation | at $25\text{ }^{\circ}\text{C}$ | P_{diss} | 70 | mW |
| OUTPUT | | | | |
| Collector emitter voltage | | V_{CEO} | 70 | V |
| Emitter collector voltage | | V_{ECO} | 7 | V |
| Collector current | | I_C | 50 | mA |
| Collector peak current | $t_p/T = 0.5, t_p \leq 10\text{ ms}$ | I_{CM} | 100 | mA |
| Output power dissipation | at $25\text{ }^{\circ}\text{C}$ | P_{diss} | 70 | mW |
| COUPLER | | | | |
| Isolation test voltage (RMS) | $t = 1\text{ s}$ | V_{ISO} | 5000 | V_{RMS} |
| Operating ambient temperature range | | T_{amb} | - 55 to + 110 | $^{\circ}\text{C}$ |
| Storage temperature range | | T_{stg} | - 55 to + 125 | $^{\circ}\text{C}$ |
| Soldering temperature ⁽¹⁾ | 2 mm from case, $\leq 10\text{ s}$ | T_{sld} | 260 | $^{\circ}\text{C}$ |

Notes

- Stresses in excess of the absolute maximum ratings can cause permanent damage to the device. Functional operation of the device is not implied at these or any other conditions in excess of those given in the operational sections of this document. Exposure to absolute maximum ratings for extended periods of the time can adversely affect reliability.
- ⁽¹⁾ Refer to reflow profile for soldering conditions for surface mounted devices (SMD), and wave profile for soldering conditions for through hole devices (DIP), please go to "Assembly Instructions" (www.vishay.com/doc?80054).



Fig. 1 - Permissible Power Dissipation vs. Ambient Temperature

| ELECTRICAL CHARACTERISTICS ($T_{amb} = 25\text{ }^{\circ}\text{C}$, unless otherwise specified) | | | | | | |
|--|--|-------------|------|------|------|---------------|
| PARAMETER | TEST CONDITION | SYMBOL | MIN. | TYP. | MAX. | UNIT |
| INPUT | | | | | | |
| Forward voltage | $I_F = 50\text{ mA}$ | V_F | | 1.43 | 1.6 | V |
| Reverse current | $V_R = 6\text{ V}$ | I_R | | | 100 | μA |
| Junction capacitance | $V_R = 0, f = 1\text{ MHz}$ | C_j | | 50 | | pF |
| OUTPUT | | | | | | |
| Collector emitter voltage | $I_C = 1\text{ mA}$ | V_{CEO} | 70 | | | V |
| Emitter collector voltage | $I_E = 100\text{ }\mu\text{A}$ | V_{ECO} | 7 | | | V |
| Collector emitter cut-off current | $V_{CE} = 20\text{ V}, I_F = 0$ | I_{CEO} | | 10 | 100 | nA |
| COUPLER | | | | | | |
| Collector emitter saturation voltage | $I_F = 10\text{ mA}, I_C = 1\text{ mA}$ | V_{CEsat} | | | 0.3 | V |
| Cut-off frequency | $V_{CE} = 5\text{ V}, I_F = 10\text{ mA}, R_L = 100\text{ }\Omega$ | f_c | | 110 | | kHz |
| Coupling capacitance | $f = 1\text{ MHz}$ | C_k | | 0.6 | | pF |

Note

- Minimum and maximum values are testing requirements. Typical values are characteristics of the device and are the result of engineering evaluation. Typical values are for information only and are not part of the testing requirements.

| CURRENT TRANSFER RATIO ($T_{amb} = 25\text{ }^{\circ}\text{C}$, unless otherwise specified) | | | | | | | |
|---|---|----------|--------|------|------|------|------|
| PARAMETER | TEST CONDITION | PART | SYMBOL | MIN. | TYP. | MAX. | UNIT |
| I_C/I_F | $V_{CE} = 5\text{ V}, I_F = 1\text{ mA}$ | VO615A-1 | CTR | 13 | 30 | | % |
| | | VO615A-2 | CTR | 22 | 45 | | % |
| | | VO615A-3 | CTR | 34 | 70 | | % |
| | | VO615A-4 | CTR | 56 | 90 | | % |
| | $V_{CE} = 5\text{ V}, I_F = 5\text{ mA}$ | VO615A | CTR | 50 | | 600 | % |
| | | VO615A-5 | CTR | 50 | | 150 | % |
| | | VO615A-6 | CTR | 100 | | 300 | % |
| | | VO615A-7 | CTR | 80 | | 160 | % |
| | | VO615A-8 | CTR | 130 | | 260 | % |
| | $V_{CE} = 5\text{ V}, I_F = 10\text{ mA}$ | VO615A-9 | CTR | 200 | | 400 | % |
| | | VO615A-1 | CTR | 40 | | 80 | % |
| | | VO615A-2 | CTR | 63 | | 125 | % |
| | | VO615A-3 | CTR | 100 | | 200 | % |
| VO615A-4 | CTR | 160 | | 320 | % | | |

| SAFETY AND INSULATION RATED PARAMETERS | | | | | | |
|---|---|------------|-----------|------|------|--------------------|
| PARAMETER | TEST CONDITION | SYMBOL | MIN. | TYP. | MAX. | UNIT |
| Partial discharge test voltage - routine test | 100 %, $t_{test} = 1\text{ s}$ | V_{pd} | 1.6 | | | kV |
| Partial discharge test voltage - lot test (sample test) | $t_{Tr} = 60\text{ s}, t_{test} = 10\text{ s}$, (see figure 2) | V_{pd} | 1.36 | | | kV |
| Insulation resistance | $V_{IO} = 500\text{ V}$ | R_{IO} | 10^{12} | | | Ω |
| | $V_{IO} = 500\text{ V}, T_{amb} = 100\text{ }^{\circ}\text{C}$ | R_{IO} | 10^{11} | | | Ω |
| | $V_{IO} = 500\text{ V}, T_{amb} = 150\text{ }^{\circ}\text{C}$ (construction test only) | R_{IO} | 10^9 | | | Ω |
| Rated impulse voltage | | V_{IOTM} | | | 6000 | V_{peak} |
| Max. working voltages | Recurring peak voltage | V_{IORM} | | | 850 | V_{peak} |
| Forward current | | I_{SI} | | | 130 | mA |
| Power dissipation | | P_{SO} | | | 265 | mW |
| Safety temperature | | T_{si} | | | 150 | $^{\circ}\text{C}$ |
| Creepage distance | | | | | 7.6 | mm |

Note

- According to DIN EN 60747-5-5 (VDE 0884), § 7.4.3.8.2 (see figure 2). This optocoupler is suitable for safe electrical isolation only within the safety ratings. Compliance with the safety ratings shall be ensured by means of suitable protective circuits.

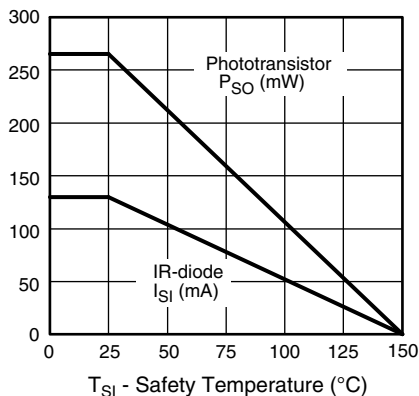

Fig. 2 - Derating Diagram

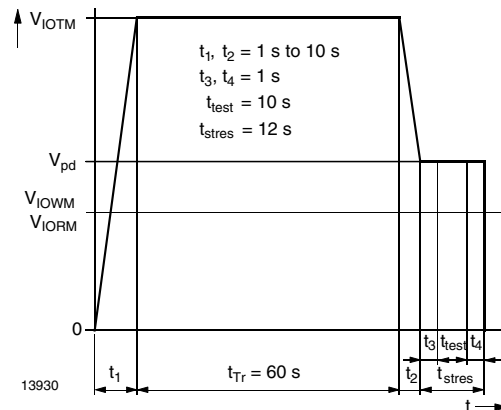

Fig. 3 - Test Pulse Diagram for Sample Test According to DIN EN 60747-5-2 (VDE 0884); IEC 60747-5-5

| SWITCHING CHARACTERISTICS ($T_{amb} = 25\text{ }^{\circ}\text{C}$, unless otherwise specified) | | | | | | |
|--|--|-----------|------|------|------|---------------|
| PARAMETER | TEST CONDITION | SYMBOL | MIN. | TYP. | MAX. | UNIT |
| Delay time | $V_S = 5\text{ V}$, $I_C = 2\text{ mA}$, $R_L = 100\ \Omega$ | t_d | | 3 | | μs |
| Rise time | $V_S = 5\text{ V}$, $I_C = 2\text{ mA}$, $R_L = 100\ \Omega$ | t_r | | 3 | | μs |
| Fall time | $V_S = 5\text{ V}$, $I_C = 2\text{ mA}$, $R_L = 100\ \Omega$ | t_f | | 4.7 | | μs |
| Storage time | $V_S = 5\text{ V}$, $I_C = 2\text{ mA}$, $R_L = 100\ \Omega$ | t_s | | 0.3 | | μs |
| Turn-on time | $V_S = 5\text{ V}$, $I_C = 2\text{ mA}$, $R_L = 100\ \Omega$ | t_{on} | | 6 | | μs |
| Turn-off time | $V_S = 5\text{ V}$, $I_C = 2\text{ mA}$, $R_L = 100\ \Omega$ | t_{off} | | 5 | | μs |
| Turn-on time | $V_S = 5\text{ V}$, $I_F = 10\text{ mA}$, $R_L = 1\text{ k}\Omega$ | t_{on} | | 3 | | μs |
| Turn-off time | $V_S = 5\text{ V}$, $I_F = 10\text{ mA}$, $R_L = 1\text{ k}\Omega$ | t_{off} | | 10 | | μs |

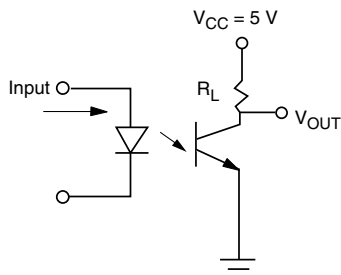

Fig. 4 - Test Circuit

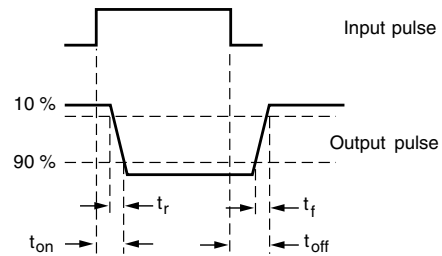

Fig. 5 - Test Circuit and Waveforms

TYPICAL CHARACTERISTICS ($T_{amb} = 25\text{ }^{\circ}\text{C}$, unless otherwise specified)

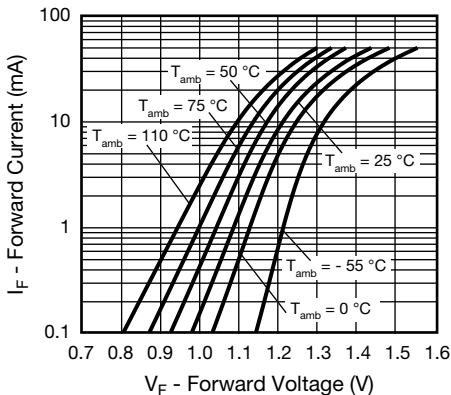

Fig. 6 - Forward Voltage vs. Forward Current

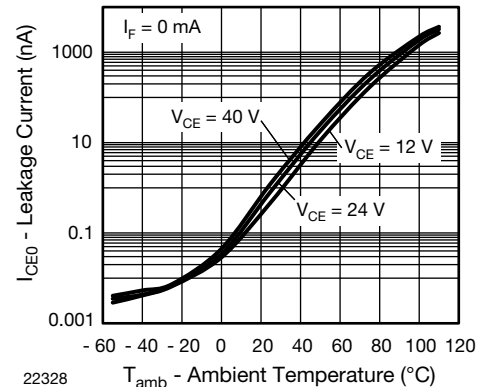

Fig. 8 - Leakage Current vs. Ambient Temperature

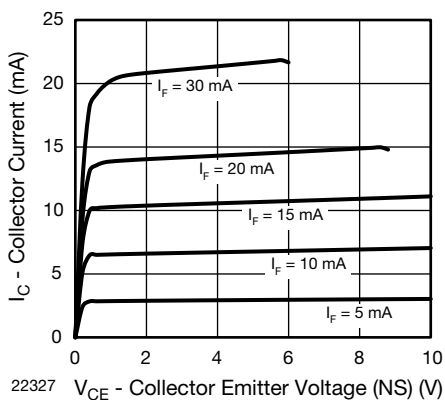

Fig. 7 - Collector Current vs. Collector Emitter Voltage (NS)

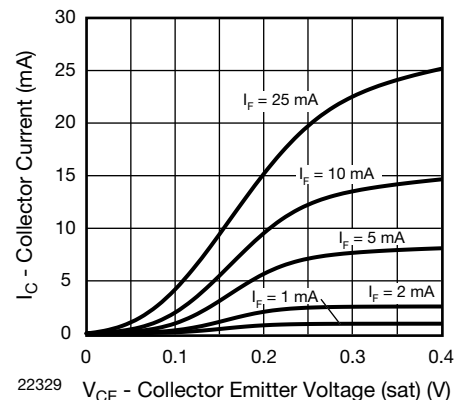

Fig. 9 - Collector Current vs. Collector Emitter Voltage (sat)

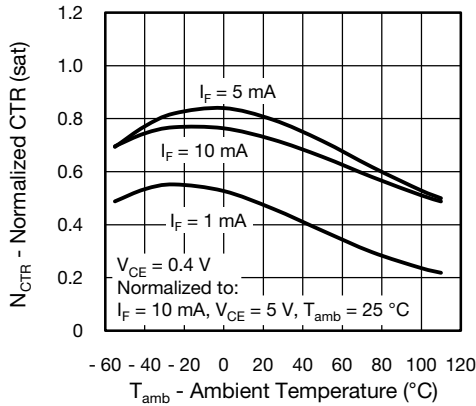

Fig. 10 - Normalized CTR (sat) vs. Ambient Temperature

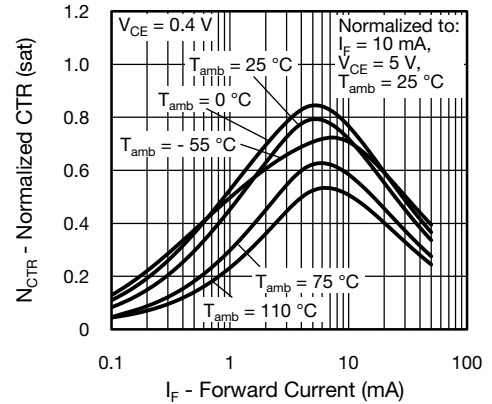

Fig. 13 - Normalized CTR (sat) vs. Forward Current



Fig. 11 - Normalized CTR (NS) vs. Ambient Temperature

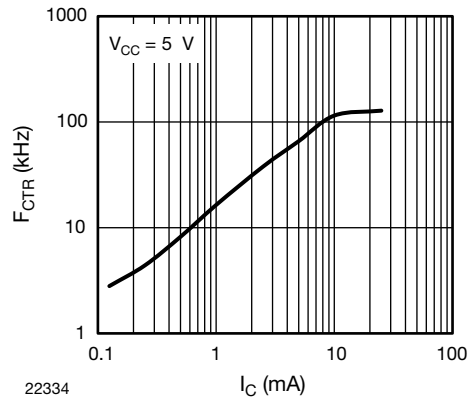

Fig. 14 - F_{CTR} vs. I_C (sat) (mA)



Fig. 12 - Normalized CTR (NS) vs. Forward Current



Fig. 15 - F_{CTR} vs. Phase Angle (kHz)

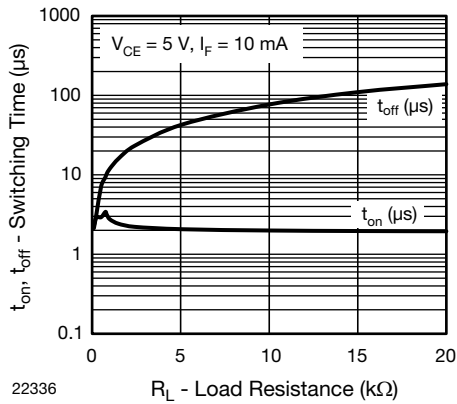
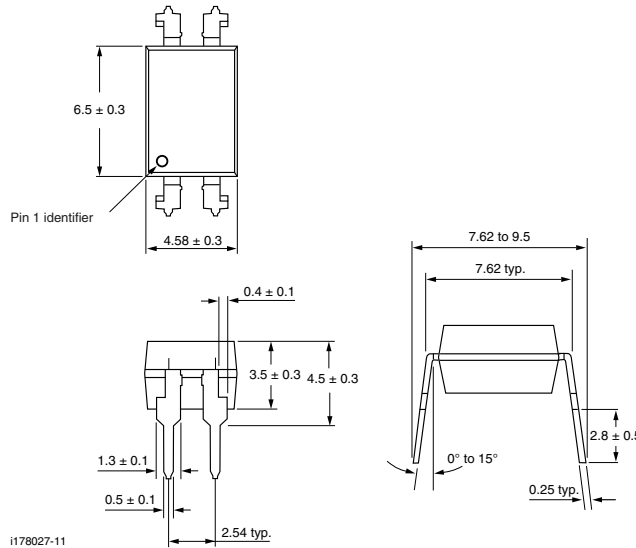
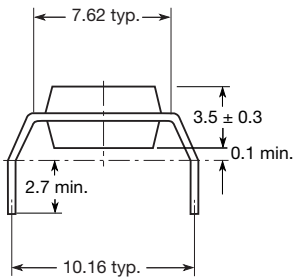

Fig. 16 - Switching Time vs. Load Resistance

PACKAGE DIMENSIONS in millimeters



Option 6



Option 7

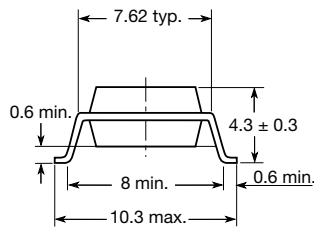

Option 8



Option 9

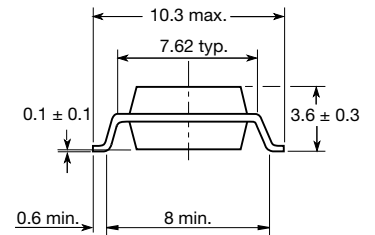

20802-36

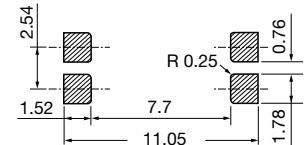
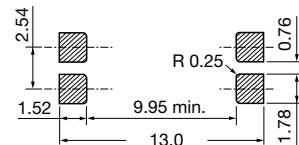
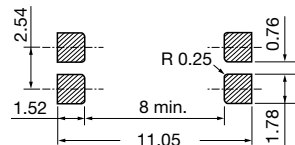

PACKAGE MARKING (Example of VO615A-3X017T)

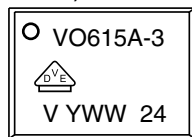

Notes

- Only options 1, 7, and 8 are reflected in the package marking.
- The VDE logo is only marked on option 1 parts.
- Tape and reel suffix (T) is not part of the package marking.

PACKING INFORMATION

| DEVICE PER TUBE | | | |
|------------------------------|------------|-----------|-----------|
| TYPE | UNITS/TUBE | TUBES/BOX | UNITS/BOX |
| DIP-4, standard and option 6 | 100 | 40 | 4000 |

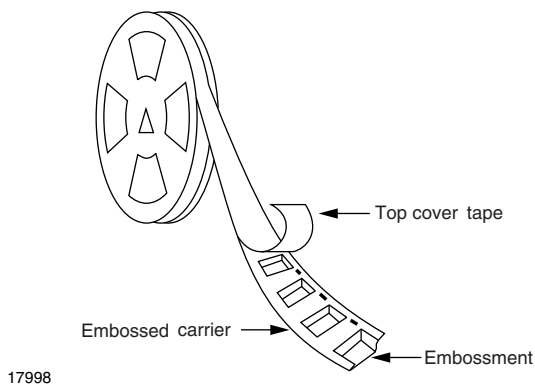

17998

Fig. 17 - Tape and Reel Shipping Medium

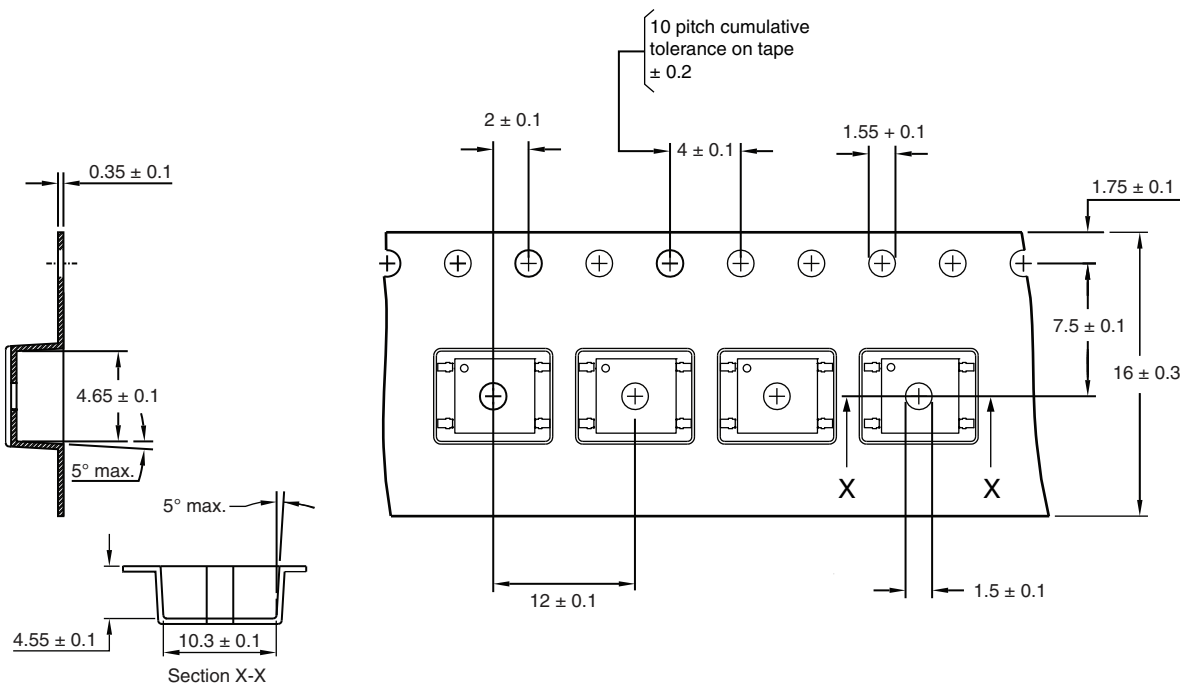

Fig. 18 - Tape and Reel Packing for Option 7 and Option 9 (1000 units per reel)

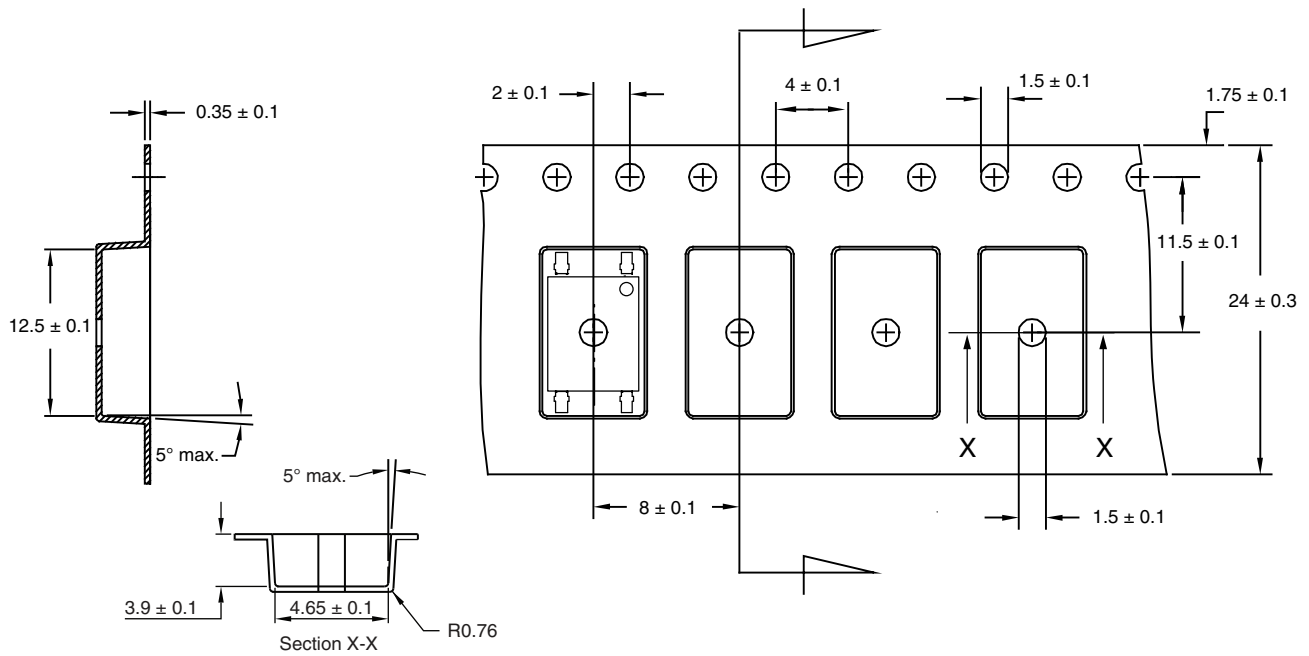

Fig. 19 - Tape and Reel Packing for Option 8
(2000 units per reel)



Disclaimer

ALL PRODUCT, PRODUCT SPECIFICATIONS AND DATA ARE SUBJECT TO CHANGE WITHOUT NOTICE TO IMPROVE RELIABILITY, FUNCTION OR DESIGN OR OTHERWISE.

Vishay Intertechnology, Inc., its affiliates, agents, and employees, and all persons acting on its or their behalf (collectively, "Vishay"), disclaim any and all liability for any errors, inaccuracies or incompleteness contained in any datasheet or in any other disclosure relating to any product.

Vishay makes no warranty, representation or guarantee regarding the suitability of the products for any particular purpose or the continuing production of any product. To the maximum extent permitted by applicable law, Vishay disclaims (i) any and all liability arising out of the application or use of any product, (ii) any and all liability, including without limitation special, consequential or incidental damages, and (iii) any and all implied warranties, including warranties of fitness for particular purpose, non-infringement and merchantability.

Statements regarding the suitability of products for certain types of applications are based on Vishay's knowledge of typical requirements that are often placed on Vishay products in generic applications. Such statements are not binding statements about the suitability of products for a particular application. It is the customer's responsibility to validate that a particular product with the properties described in the product specification is suitable for use in a particular application. Parameters provided in datasheets and/or specifications may vary in different applications and performance may vary over time. All operating parameters, including typical parameters, must be validated for each customer application by the customer's technical experts. Product specifications do not expand or otherwise modify Vishay's terms and conditions of purchase, including but not limited to the warranty expressed therein.

Except as expressly indicated in writing, Vishay products are not designed for use in medical, life-saving, or life-sustaining applications or for any other application in which the failure of the Vishay product could result in personal injury or death. Customers using or selling Vishay products not expressly indicated for use in such applications do so at their own risk. Please contact authorized Vishay personnel to obtain written terms and conditions regarding products designed for such applications.

No license, express or implied, by estoppel or otherwise, to any intellectual property rights is granted by this document or by any conduct of Vishay. Product names and markings noted herein may be trademarks of their respective owners.

Material Category Policy

Vishay Intertechnology, Inc. hereby certifies that all its products that are identified as RoHS-Compliant fulfill the definitions and restrictions defined under Directive 2011/65/EU of The European Parliament and of the Council of June 8, 2011 on the restriction of the use of certain hazardous substances in electrical and electronic equipment (EEE) - recast, unless otherwise specified as non-compliant.

Please note that some Vishay documentation may still make reference to RoHS Directive 2002/95/EC. We confirm that all the products identified as being compliant to Directive 2002/95/EC conform to Directive 2011/65/EU.

Vishay Intertechnology, Inc. hereby certifies that all its products that are identified as Halogen-Free follow Halogen-Free requirements as per JEDEC JS709A standards. Please note that some Vishay documentation may still make reference to the IEC 61249-2-21 definition. We confirm that all the products identified as being compliant to IEC 61249-2-21 conform to JEDEC JS709A standards.



Компания «ЭлектроПласт» предлагает заключение долгосрочных отношений при поставках импортных электронных компонентов на взаимовыгодных условиях!

Наши преимущества:

- Оперативные поставки широкого спектра электронных компонентов отечественного и импортного производства напрямую от производителей и с крупнейших мировых складов;
- Поставка более 17-ти миллионов наименований электронных компонентов;
- Поставка сложных, дефицитных, либо снятых с производства позиций;
- Оперативные сроки поставки под заказ (от 5 рабочих дней);
- Экспресс доставка в любую точку России;
- Техническая поддержка проекта, помощь в подборе аналогов, поставка прототипов;
- Система менеджмента качества сертифицирована по Международному стандарту ISO 9001;
- Лицензия ФСБ на осуществление работ с использованием сведений, составляющих государственную тайну;
- Поставка специализированных компонентов (Xilinx, Altera, Analog Devices, Intersil, Interpoint, Microsemi, Aeroflex, Peregrine, Syfer, Eurofarad, Texas Instrument, Miteq, Cobham, E2V, MA-COM, Hittite, Mini-Circuits, General Dynamics и др.);

Помимо этого, одним из направлений компании «ЭлектроПласт» является направление «Источники питания». Мы предлагаем Вам помощь Конструкторского отдела:

- Подбор оптимального решения, техническое обоснование при выборе компонента;
- Подбор аналогов;
- Консультации по применению компонента;
- Поставка образцов и прототипов;
- Техническая поддержка проекта;
- Защита от снятия компонента с производства.



Как с нами связаться

Телефон: 8 (812) 309 58 32 (многоканальный)

Факс: 8 (812) 320-02-42

Электронная почта: org@eplast1.ru

Адрес: 198099, г. Санкт-Петербург, ул. Калинина, дом 2, корпус 4, литера А.