

Automotive-grade N-channel 600 V, 0.8 Ω typ., 5 A MDmesh™ II Power MOSFETs in D²PAK and DPAK packages

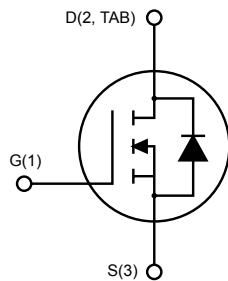
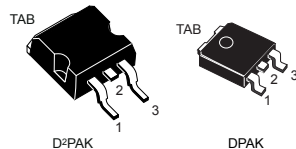

AM01475v1_noZen

Features

Order code	V _{DS}	R _{DS(on)} max.	I _D	Package
STB7ANM60N	600 V	0.9 Ω	5 A	D ² PAK
STD7ANM60N				DPAK



- AEC-Q101 qualified
- 100% avalanche tested
- Low input capacitance and gate charge
- Low gate input resistance

Applications

- Switching applications

Description

These devices are N-channel Power MOSFETs developed using the second generation of MDmesh™ technology. These revolutionary Power MOSFETs associate a vertical structure to the company's strip layout to yield one of the world's lowest on-resistance and gate charge. They are therefore suitable for the most demanding high-efficiency converters.



Product status link

[STB7ANM60N](#)
[STD7ANM60N](#)

Product summary

Order code	STB7ANM60N
Marking	7ANM60N
Package	D ² PAK
Packing	Tape and reel
Order code	STD7ANM60N
Marking	7ANM60N
Package	DPAK
Packing	Tape and reel

1 Electrical ratings

Table 1. Absolute maximum ratings

Symbol	Parameter	Value	Unit
V_{DS}	Drain-source voltage	600	V
V_{GS}	Gate-source voltage	± 25	V
I_D	Drain current (continuous) at $T_C = 25\text{ }^\circ\text{C}$	5	A
I_D	Drain current (continuous) at $T_C = 100\text{ }^\circ\text{C}$	3	A
$I_{DM}^{(1)}$	Drain current (pulsed)	20	A
P_{TOT}	Total power dissipation at $T_C = 25\text{ }^\circ\text{C}$	45	W
$dv/dt^{(2)}$	Peak diode recovery voltage slope	15	V/ns
T_j	Operating junction temperature range	-55 to 150	$^\circ\text{C}$
T_{stg}	Storage temperature range		

1. Pulse width limited by safe operating area.

2. $I_{SD} \leq 5\text{ A}$, $di/dt \leq 400\text{ A}/\mu\text{s}$, $V_{DSpeak} \leq V_{(BR)DSS}$, $V_{DD} = 80\% V_{(BR)DSS}$.

Table 2. Thermal data

Symbol	Parameter	Value		Unit
		D ² PAK	DPAK	
$R_{thj-case}$	Thermal resistance junction-case	2.78		$^\circ\text{C}/\text{W}$
$R_{thj-pcb}^{(1)}$	Thermal resistance junction-pcb	35	50	$^\circ\text{C}/\text{W}$

1. When mounted on 1inch² FR-4 board, 2 oz Cu.

Table 3. Avalanche characteristics

Symbol	Parameter	Value	Unit
I_{AS}	Avalanche current, repetitive or not-repetitive (pulse width limited by T_{jmax})	2	A
E_{AS}	Single pulse avalanche energy (starting $T_j = 25\text{ }^\circ\text{C}$, $I_D = I_{AS}$, $V_{DD} = 50\text{ V}$)	119	mJ

2 Electrical characteristics

($T_{CASE} = 25\text{ °C}$ unless otherwise specified)

Table 4. On/off states

Symbol	Parameter	Test conditions	Min.	Typ.	Max.	Unit
$V_{(BR)DSS}$	Drain-source breakdown voltage	$I_D = 1\text{ mA}$, $V_{GS} = 0\text{ V}$	600			V
I_{DSS}	Zero gate voltage drain current	$V_{GS} = 0\text{ V}$, $V_{DS} = 600\text{ V}$			1	μA
		$V_{GS} = 0\text{ V}$, $V_{DS} = 600\text{ V}$, $T_C = 125\text{ °C}$ ⁽¹⁾			100	μA
I_{GSS}	Gate body leakage current	$V_{DS} = 0\text{ V}$, $V_{GS} = \pm 20\text{ V}$			± 100	nA
$V_{GS(th)}$	Gate threshold voltage	$V_{DS} = V_{GS}$, $I_D = 250\text{ }\mu\text{A}$	2	3	4	V
$R_{DS(on)}$	Static drain-source on resistance	$V_{GS} = 10\text{ V}$, $I_D = 2.5\text{ A}$		0.8	0.9	Ω

1. Defined by design, not subject to production test.

Table 5. Dynamic

Symbol	Parameter	Test conditions	Min.	Typ.	Max.	Unit
C_{iss}	Input capacitance	$V_{DS} = 50\text{ V}$, $f = 1\text{ MHz}$, $V_{GS} = 0\text{ V}$	-	363	-	μF
C_{oss}	Output capacitance			24.6		
C_{rSS}	Reverse transfer capacitance			1.1		
$C_{oss\text{ eq.}}^{(1)}$	Equivalent capacitance time related	$V_{DS} = 0\text{ to }480\text{ V}$, $V_{GS} = 0\text{ V}$	-	130	-	μF
R_G	Intrinsic gate resistance	$f = 1\text{ MHz}$ open drain	-	5.4	-	Ω
Q_g	Total gate charge	$V_{DD} = 480\text{ V}$, $I_D = 5\text{ A}$, $V_{GS} = 0\text{ to }10\text{ V}$ (see Figure 15. Test circuit for gate charge behavior)	-	14	-	nC
Q_{gs}	Gate-source charge			2.7		
Q_{gd}	Gate-drain charge			7.7		

1. $C_{oss\text{ eq.}}$ is defined as a constant equivalent capacitance giving the same charging time as C_{oss} when V_{DS} increases from 0 to 80% V_{DSS} .

Table 6. Switching times

Symbol	Parameter	Test conditions	Min.	Typ.	Max.	Unit
$t_{d(on)}$	Turn-on delay time	$V_{DD} = 300\text{ V}$, $I_D = 2.5\text{ A}$, $R_G = 4.7\text{ }\Omega$, $V_{GS} = 10\text{ V}$ (see Figure 14. Test circuit for resistive load switching times and Figure 19. Switching time waveform)	-	7	-	ns
t_r	Rise time			10		
$t_{d(off)}$	Turn-off delay time			26		
t_f	Fall time			12		

Table 7. Source-drain diode

Symbol	Parameter	Test conditions	Min.	Typ.	Max.	Unit
I_{SD}	Source-drain current				5	A
$I_{SDM}^{(1)}$	Source-drain current (pulsed)		-		20	
$V_{SD}^{(2)}$	Forward on voltage	$I_{SD} = 5\text{ A}$, $V_{GS} = 0\text{ V}$	-		1.3	V
t_{rr}	Reverse recovery time	$I_{SD} = 5\text{ A}$, $di/dt = 100\text{ A}/\mu\text{s}$		213		ns
Q_{rr}	Reverse recovery charge	$V_{DD} = 60\text{ V}$ (see Figure 16. Test circuit for inductive load switching and diode recovery times)	-	1.5		μC
I_{RRM}	Reverse recovery current			14		A
t_{rr}	Reverse recovery time	$I_{SD} = 5\text{ A}$, $di/dt = 100\text{ A}/\mu\text{s}$		265		ns
Q_{rr}	Reverse recovery charge	$V_{DD} = 60\text{ V}$, $T_j = 150\text{ }^\circ\text{C}$ (see Figure 16. Test circuit for inductive load switching and diode recovery times)	-	1.8		μC
I_{RRM}	Reverse recovery current			14		A

1. Pulse width limited by safe operating area.
2. Pulsed: pulse duration = 300 μs , duty cycle 1.5%.

2.1 Electrical characteristics curves

Figure 1. Safe operating area for D²PAK

Figure 2. Thermal impedance for D²PAK

Figure 3. Safe operating area for DPAK

Figure 4. Thermal impedance for DPAK

Figure 5. Output characteristics

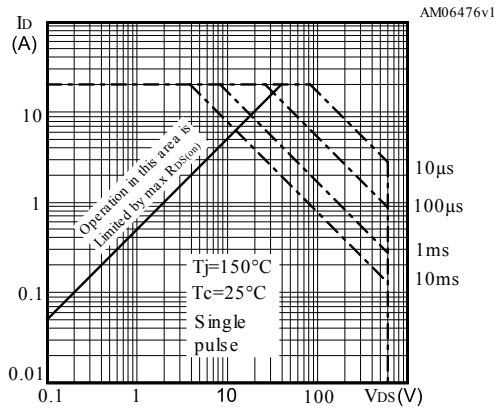
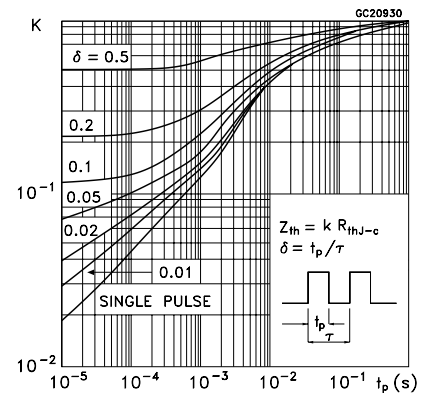
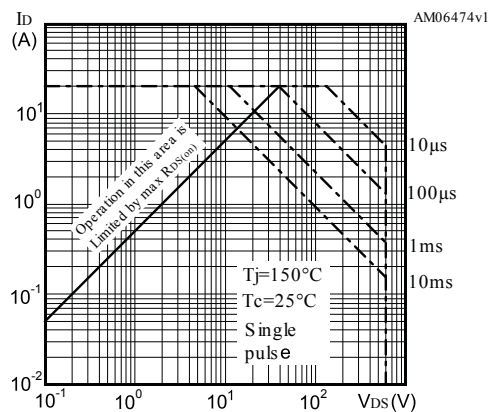
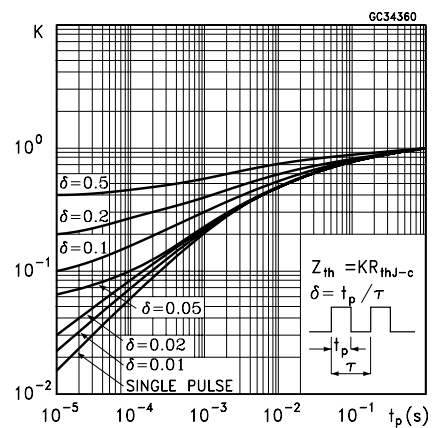
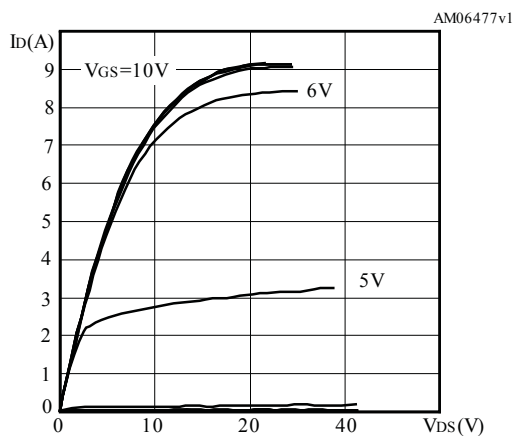
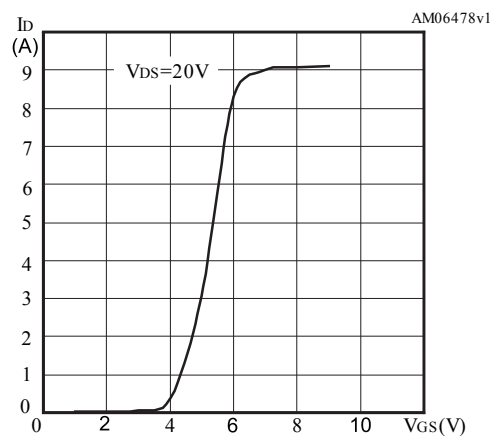
Figure 6. Transfer characteristics

Figure 7. Gate charge vs gate-source voltage

Figure 8. Static drain-source on-resistance

Figure 9. Capacitance variations

Figure 10. Output capacitance stored energy

Figure 11. Normalized gate threshold voltage vs temperature

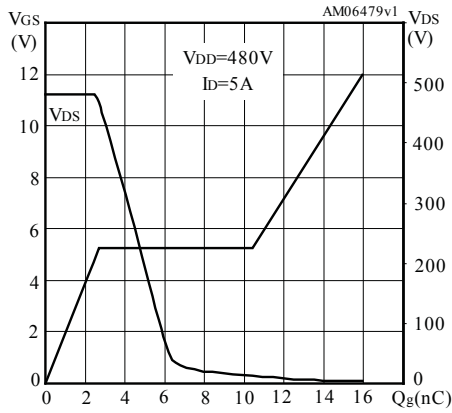
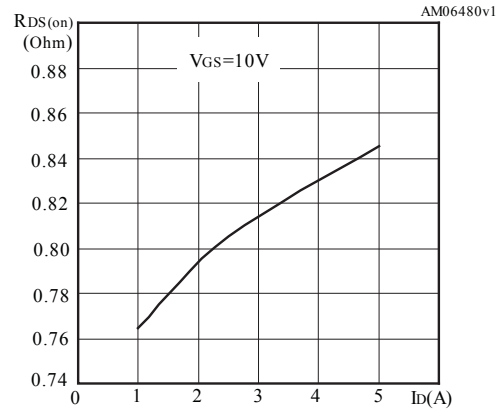
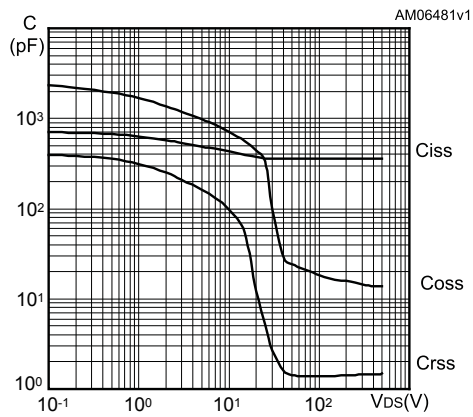
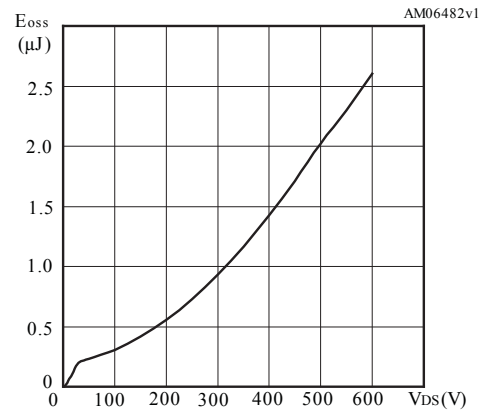
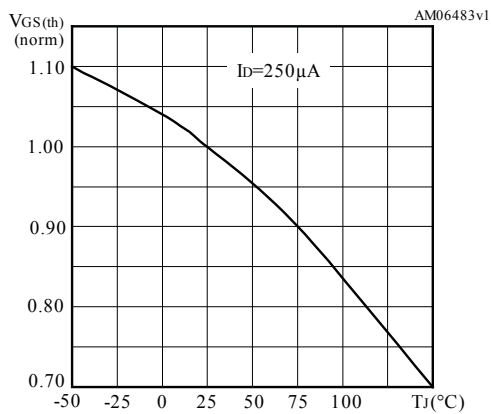
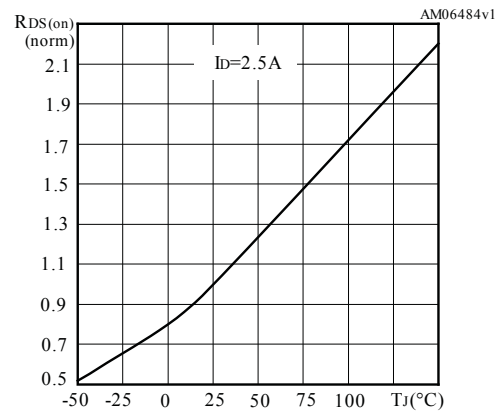
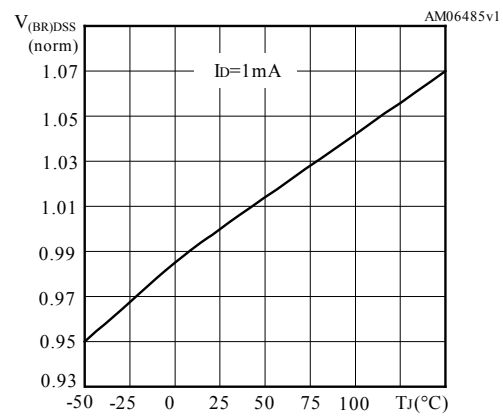
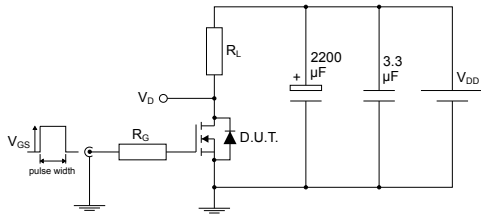
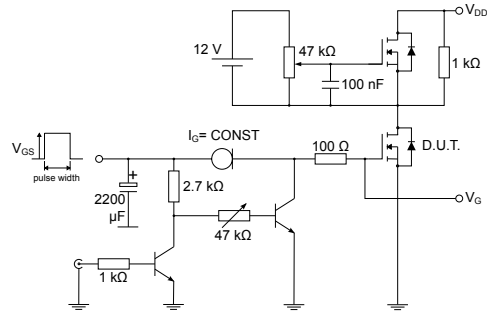
Figure 12. Normalized on-resistance vs temperature

Figure 13. Normalized $V_{(BR)DSS}$ vs temperature

3 Test circuits

Figure 14. Test circuit for resistive load switching times

AM01468v1

Figure 15. Test circuit for gate charge behavior

AM01469v1

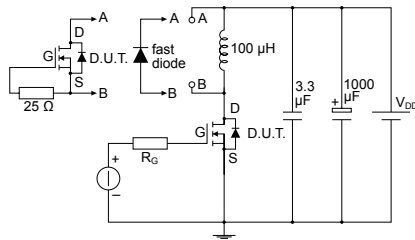
Figure 16. Test circuit for inductive load switching and diode recovery times

AM01470v1

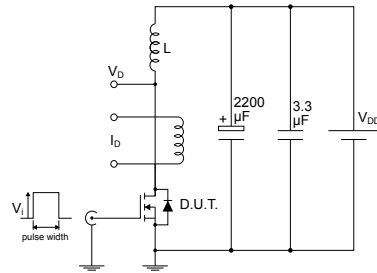
Figure 17. Unclamped inductive load test circuit

AM01471v1

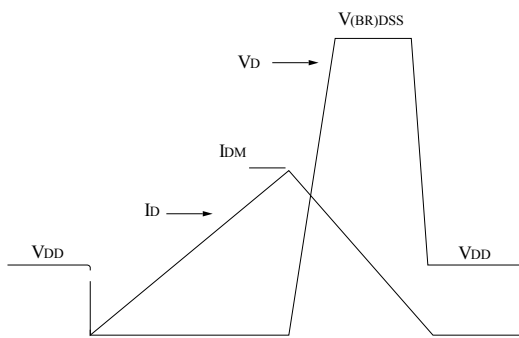
Figure 18. Unclamped inductive waveform

AM01472v1

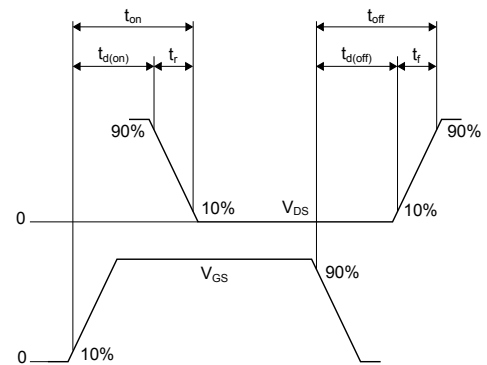
Figure 19. Switching time waveform

AM01473v1

4 Package information

In order to meet environmental requirements, ST offers these devices in different grades of **ECOPACK[®]** packages, depending on their level of environmental compliance. ECOPACK[®] specifications, grade definitions and product status are available at: www.st.com. ECOPACK[®] is an ST trademark.

4.1 D²PAK (TO-263) type A package information

Figure 20. D²PAK (TO-263) type A package outline

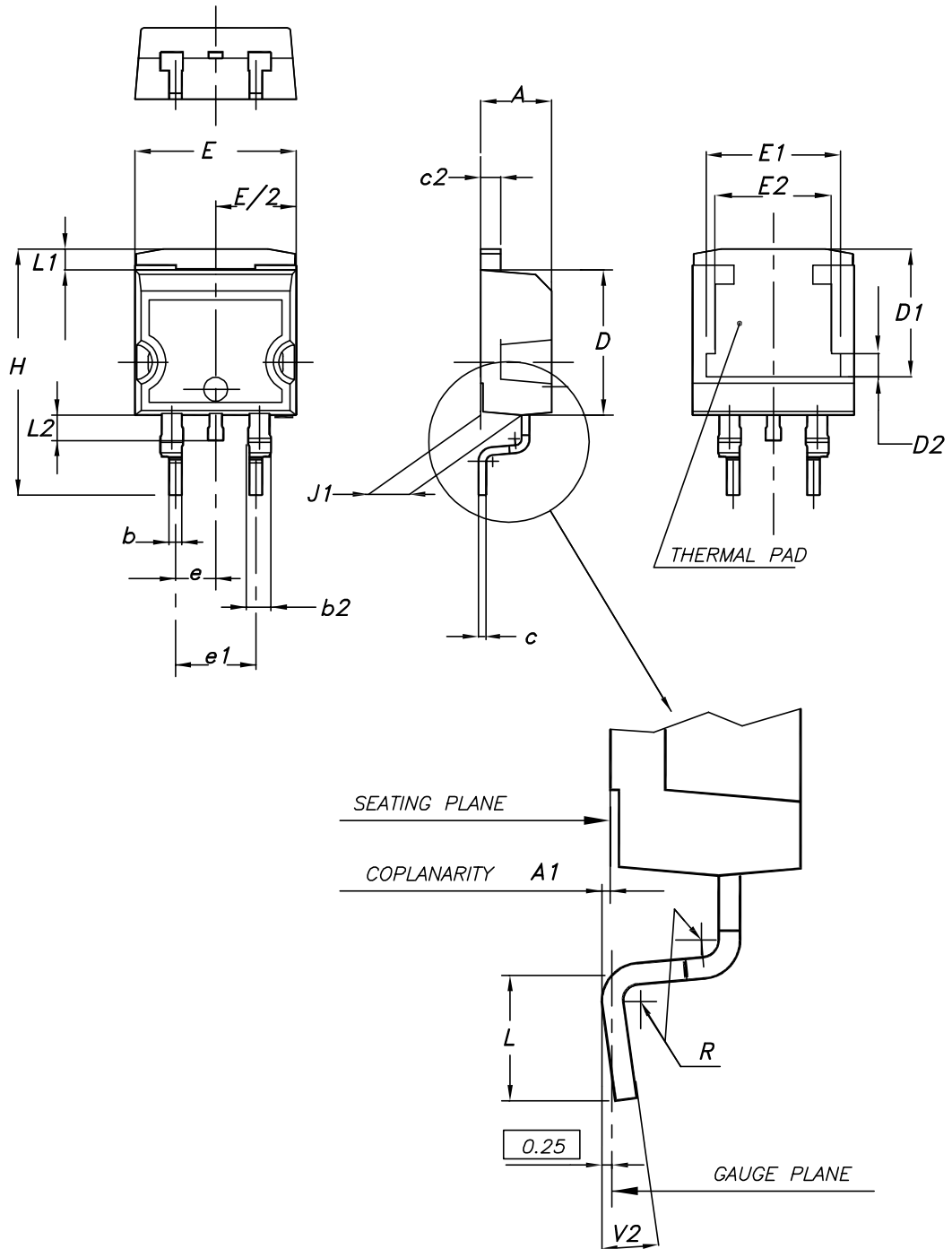

0079457_25

Table 8. D²PAK (TO-263) type A package mechanical data

Dim.	mm		
	Min.	Typ.	Max.
A	4.40		4.60
A1	0.03		0.23
b	0.70		0.93
b2	1.14		1.70
c	0.45		0.60
c2	1.23		1.36
D	8.95		9.35
D1	7.50	7.75	8.00
D2	1.10	1.30	1.50
E	10.00		10.40
E1	8.30	8.50	8.70
E2	6.85	7.05	7.25
e		2.54	
e1	4.88		5.28
H	15.00		15.85
J1	2.49		2.69
L	2.29		2.79
L1	1.27		1.40
L2	1.30		1.75
R		0.40	
V2	0°		8°

4.2 DPAK (TO-252) type A package information

Figure 21. DPAK (TO-252) type A package outline

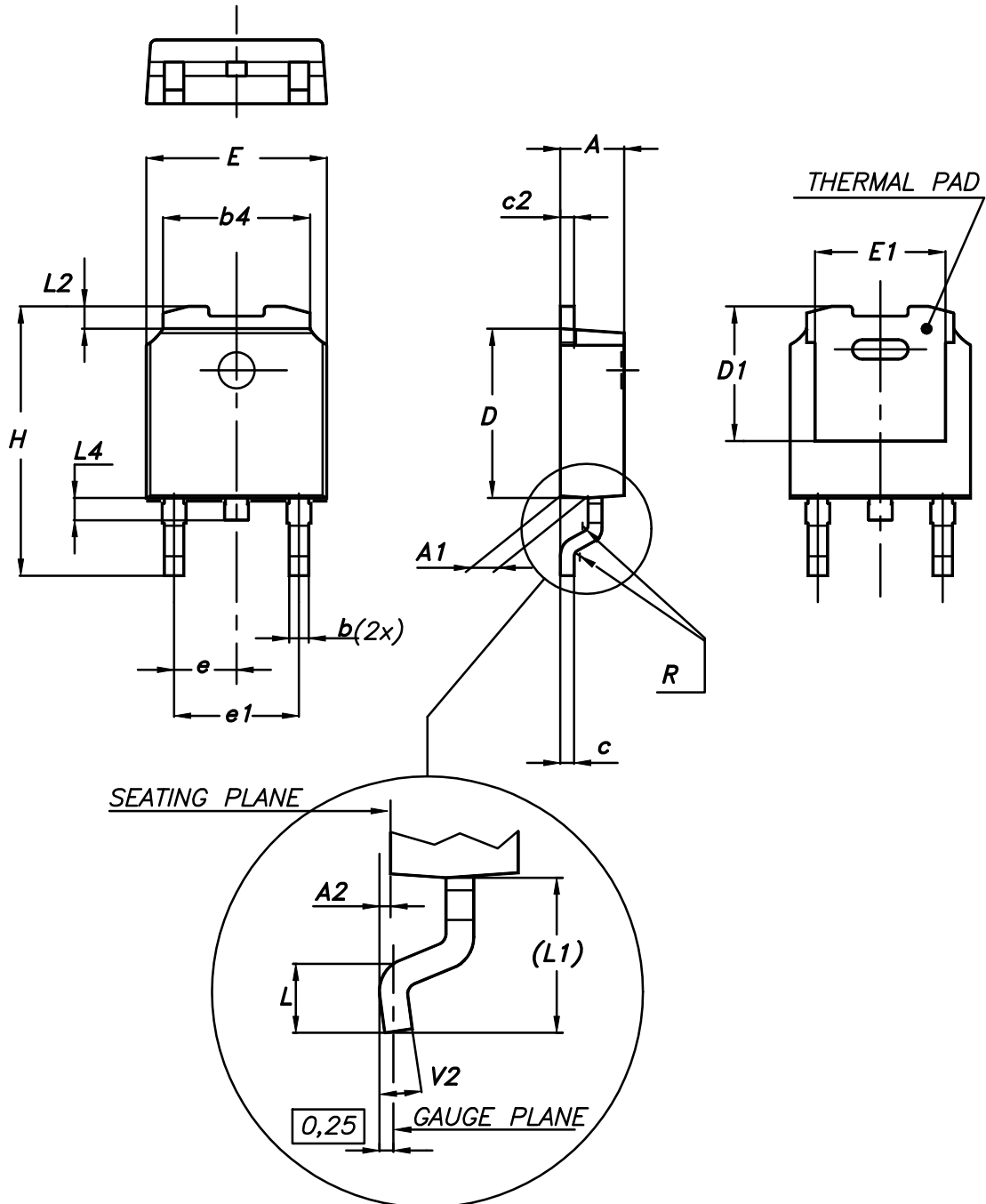

0068772_A_26

Table 9. DPAK (TO-252) type A mechanical data

Dim.	mm		
	Min.	Typ.	Max.
A	2.20		2.40
A1	0.90		1.10
A2	0.03		0.23
b	0.64		0.90
b4	5.20		5.40
c	0.45		0.60
c2	0.48		0.60
D	6.00		6.20
D1	4.95	5.10	5.25
E	6.40		6.60
E1	4.60	4.70	4.80
e	2.159	2.286	2.413
e1	4.445	4.572	4.699
H	9.35		10.10
L	1.00		1.50
(L1)	2.60	2.80	3.00
L2	0.65	0.80	0.95
L4	0.60		1.00
R		0.20	
V2	0°		8°

Figure 22. DPAK (TO-252) type A recommended footprint (dimensions are in mm)

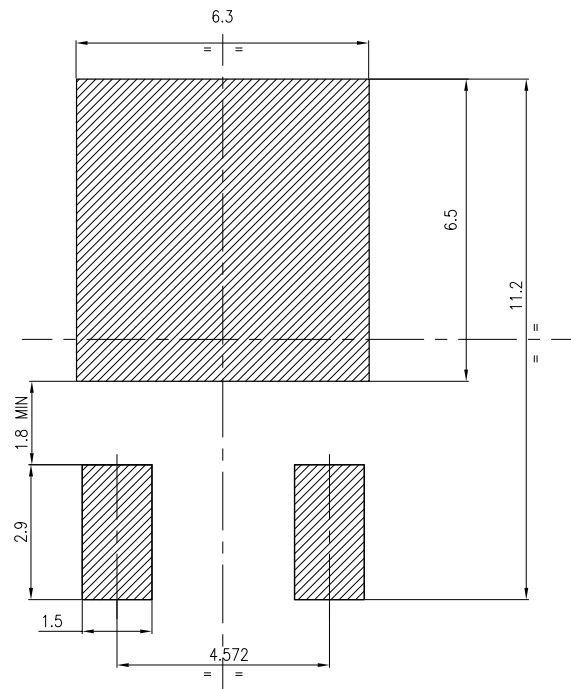

FP_0068772_26

4.3 D²PAK and DPAK packing information

Figure 23. Tape outline

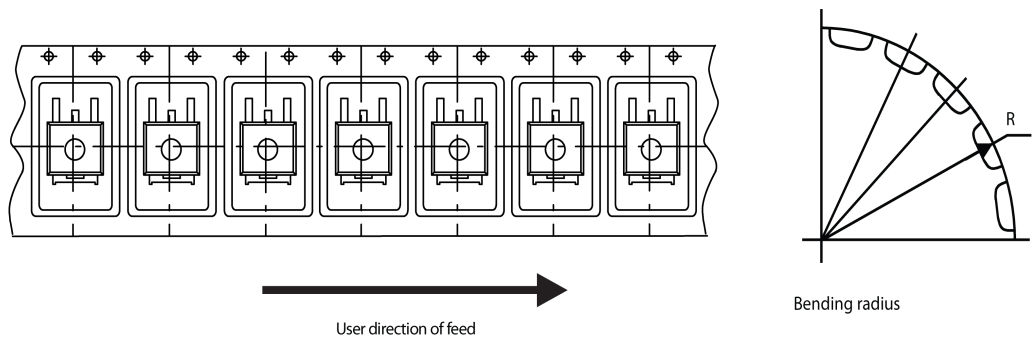
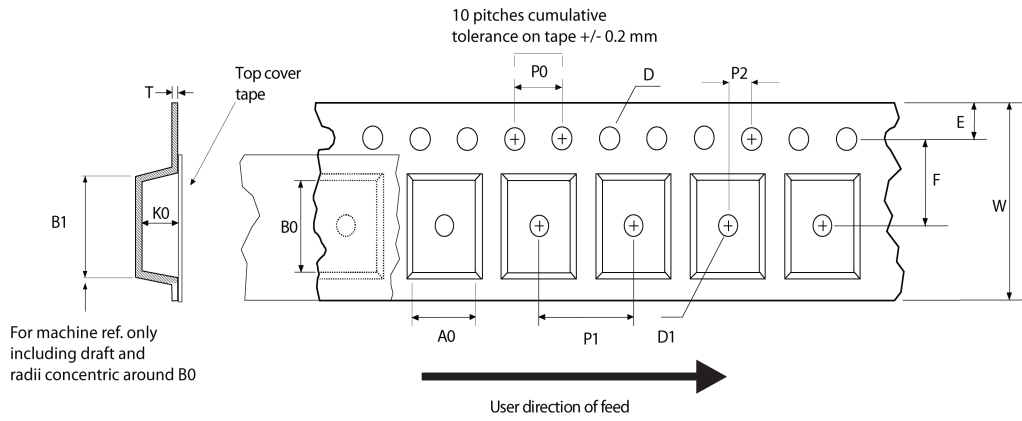

AM08852v1

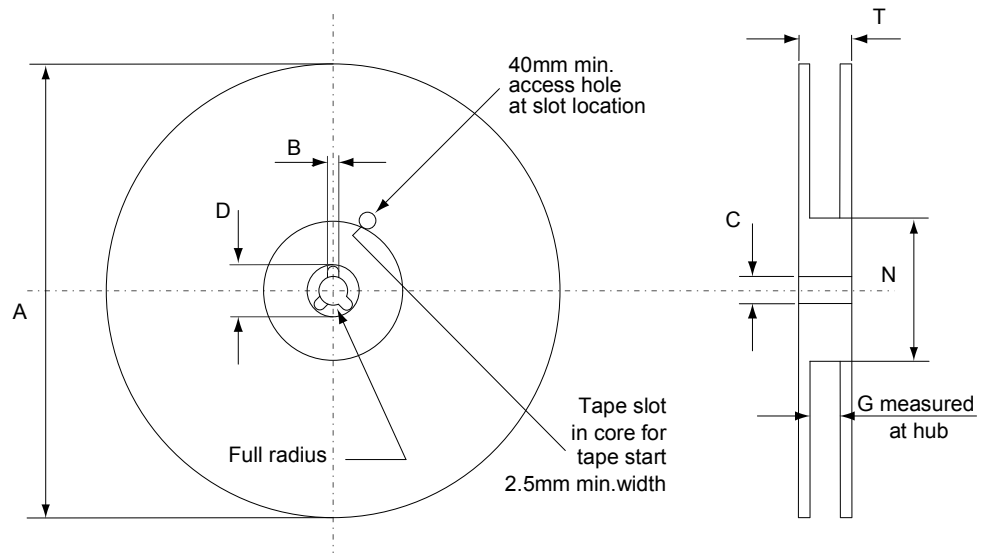
Figure 24. Reel outline

AM06038v1

Table 10. D²PAK tape and reel mechanical data

Tape			Reel		
Dim.	mm		Dim.	mm	
	Min.	Max.		Min.	Max.
A0	10.5	10.7	A		330
B0	15.7	15.9	B	1.5	
D	1.5	1.6	C	12.8	13.2
D1	1.59	1.61	D	20.2	
E	1.65	1.85	G	24.4	26.4
F	11.4	11.6	N	100	
K0	4.8	5.0	T		30.4
P0	3.9	4.1	Base quantity		
P1	11.9	12.1			
P2	1.9	2.1	Bulk quantity		
R	50				
T	0.25	0.35			
W	23.7	24.3			

Table 11. DPAK tape and reel mechanical data

Tape			Reel		
Dim.	mm		Dim.	mm	
	Min.	Max.		Min.	Max.
A0	6.8	7	A		330
B0	10.4	10.6	B	1.5	
B1		12.1	C	12.8	13.2
D	1.5	1.6	D	20.2	
D1	1.5		G	16.4	18.4
E	1.65	1.85	N	50	
F	7.4	7.6	T		22.4
K0	2.55	2.75			
P0	3.9	4.1	Base qty.		2500
P1	7.9	8.1	Bulk qty.		2500
P2	1.9	2.1			
R	40				
T	0.25	0.35			
W	15.7	16.3			

Revision history

Table 12. Document revision history

Date	Version	Changes
21-Jun-2012	1	First release.
12-Dec-2013	2	<ul style="list-style-type: none"> – Modified: title, Features and <i>Table 1</i> in cover page – Modified: <i>Figure 15, 16, 17</i> and <i>18</i> – Updated: <i>Table 10</i> and <i>Figure 23, 24</i> – Minor text changes
07-Nov-2018	3	<p>Removed maturity status indication from cover page. The document status is production data.</p> <p>Modified Table 4. On/off states.</p> <p>Updated Section 4 Package information.</p> <p>Minor text changes.</p>

Contents

1	Electrical ratings	2
2	Electrical characteristics	3
2.1	Electrical characteristics curves	5
3	Test circuits	8
4	Package information	9
4.1	D ² PAK (TO-263) type A package information	9
4.2	DPAK (TO-252) type A package information	11
4.3	D ² PAK and DPAK packing information	14
	Revision history	18

IMPORTANT NOTICE – PLEASE READ CAREFULLY

STMicroelectronics NV and its subsidiaries (“ST”) reserve the right to make changes, corrections, enhancements, modifications, and improvements to ST products and/or to this document at any time without notice. Purchasers should obtain the latest relevant information on ST products before placing orders. ST products are sold pursuant to ST’s terms and conditions of sale in place at the time of order acknowledgement.

Purchasers are solely responsible for the choice, selection, and use of ST products and ST assumes no liability for application assistance or the design of Purchasers’ products.

No license, express or implied, to any intellectual property right is granted by ST herein.

Resale of ST products with provisions different from the information set forth herein shall void any warranty granted by ST for such product.

ST and the ST logo are trademarks of ST. All other product or service names are the property of their respective owners.

Information in this document supersedes and replaces information previously supplied in any prior versions of this document.

© 2018 STMicroelectronics – All rights reserved



Компания «ЭлектроПласт» предлагает заключение долгосрочных отношений при поставках импортных электронных компонентов на взаимовыгодных условиях!

Наши преимущества:

- Оперативные поставки широкого спектра электронных компонентов отечественного и импортного производства напрямую от производителей и с крупнейших мировых складов;
- Поставка более 17-ти миллионов наименований электронных компонентов;
- Поставка сложных, дефицитных, либо снятых с производства позиций;
- Оперативные сроки поставки под заказ (от 5 рабочих дней);
- Экспресс доставка в любую точку России;
- Техническая поддержка проекта, помощь в подборе аналогов, поставка прототипов;
- Система менеджмента качества сертифицирована по Международному стандарту ISO 9001;
- Лицензия ФСБ на осуществление работ с использованием сведений, составляющих государственную тайну;
- Поставка специализированных компонентов (Xilinx, Altera, Analog Devices, Intersil, Interpoint, Microsemi, Aeroflex, Peregrine, Syfer, Eurofarad, Texas Instrument, Miteq, Cobham, E2V, MA-COM, Hittite, Mini-Circuits, General Dynamics и др.);

Помимо этого, одним из направлений компании «ЭлектроПласт» является направление «Источники питания». Мы предлагаем Вам помощь Конструкторского отдела:

- Подбор оптимального решения, техническое обоснование при выборе компонента;
- Подбор аналогов;
- Консультации по применению компонента;
- Поставка образцов и прототипов;
- Техническая поддержка проекта;
- Защита от снятия компонента с производства.



Как с нами связаться

Телефон: 8 (812) 309 58 32 (многоканальный)

Факс: 8 (812) 320-02-42

Электронная почта: org@eplast1.ru

Адрес: 198099, г. Санкт-Петербург, ул. Калинина, дом 2, корпус 4, литера А.