

ZXTP2041F

40V PNP SILICON PLANAR MEDIUM POWER TRANSISTOR

Features

- $V_{(BR)CEO} > -40V$
- High current capability $I_C = -1A$
- Low saturation voltage $V_{CE(sat)} < -500mV @ -1A$
- "Lead Free", RoHS Compliant (Note 1)

Application

- Power MOSFET gate driving
- Low loss power switching

Mechanical Data

- Case: SOT23
- Moisture Sensitivity: Level 1 per J-STD-020
- UL Flammability Rating 94V-0
- Terminals: Matte Tin Finish
- Weight: 0.008 grams (Approximate)



Top View

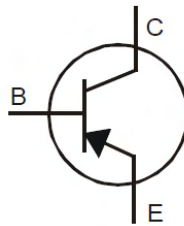

Device symbol

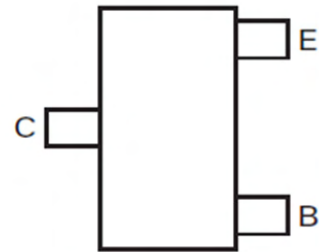

Pin-out Top

Ordering Information (Note 2)

Product	Marking	Reel size (inches)	Tape width (mm)	Quantity per reel
ZXTP2041FTA	P41	7	8	3,000

- Notes:
1. No purposefully added lead.
 2. For packaging details, go to our website at <http://www.diodes.com>.

Marking Information

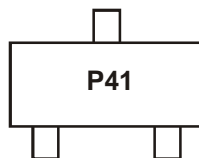

P41 = Product Type Marking Code

Maximum Ratings @ $T_A = 25^\circ\text{C}$ unless otherwise specified

Characteristic	Symbol	Value	Unit
Collector-Base Voltage	V_{CB0}	-40	V
Collector-Emitter Voltage	V_{CEO}	-40	V
Emitter-Base Voltage	V_{EBO}	-5	V
Continuous Collector Current (Note 3)	I_C	-1	A
Peak Pulse Current	I_{CM}	-2	A
Peak Base Current	I_{BM}	-1	A

Thermal Characteristics @ $T_A = 25^\circ\text{C}$ unless otherwise specified

Characteristic	Symbol	Value	Unit
Collector Power Dissipation (Note 3)	P_D	350	mW
Thermal Resistance, Junction to Ambient (Note 3)	$R_{\theta JA}$	357	$^\circ\text{C/W}$
Operating and Storage Temperature Range	T_J, T_{STG}	-55 to +150	$^\circ\text{C}$

Notes: 3. For the device mounted on 15mm x 15mm x 1.6mm FR4 PCB with high coverage of single sided 1oz copper, in still air conditions.

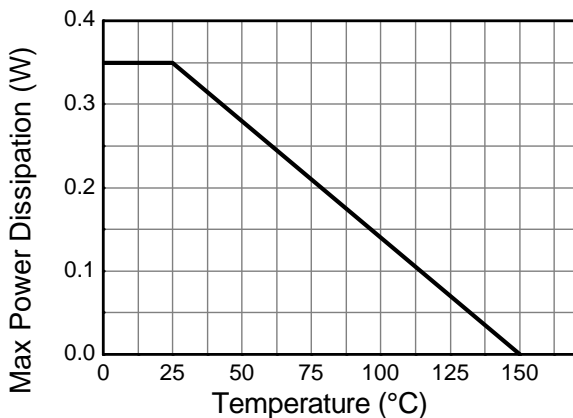

Derating Curve

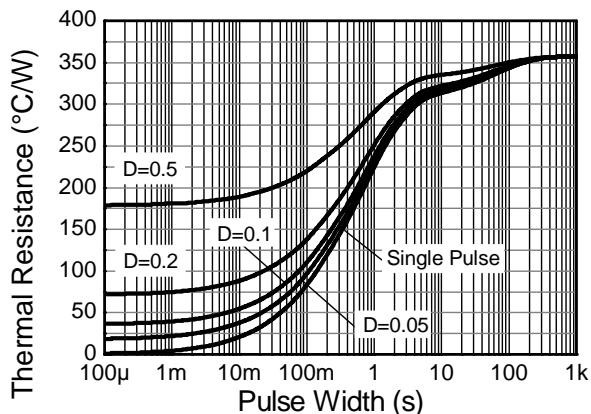

Transient Thermal Impedance

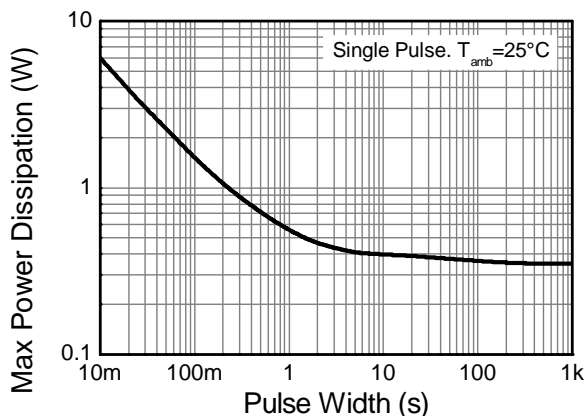

Pulse Power Dissipation

Electrical Characteristics @T_A = 25°C unless otherwise specified

Characteristic	Symbol	Min	Typ.	Max	Unit	Test Condition
Collector-Base Breakdown Voltage	V _{(BR)CBO}	-40	-	-	V	I _C = -100μA
Collector-Emitter Breakdown Voltage (Note 4)	V _{(BR)CEO}	-40	-	-	V	I _C = -10mA
Emitter-Base Breakdown Voltage	V _{(BR)EBO}	-5	-	-	V	I _E = -100μA
Collector Cutoff Current	I _{CBO}	-	-	-100	nA	V _{CB} = -30V
Emitter Cutoff Current	I _{EBO}	-	-	-100	nA	V _{EB} = -4V
Emitter Cutoff Current	I _{CES}	-	-	-100	nA	V _{CE} = -30V
DC current transfer Static ratio (Note 4)	h _{FE}	300	-	-	-	I _C = -1mA, V _{CE} = -5V
		300	-	800		I _C = -100mA, V _{CE} = -5V
		250	-	-		I _C = -500mA, V _{CE} = -5V
		160	-	-		I _C = -1A, V _{CE} = -5V
		30	-	-		I _C = -2A, V _{CE} = -5V
Collector-Emitter Saturation Voltage (Note 4)	V _{CE(sat)}	-	-	-0.20	V	I _C = -100mA, I _B = -1mA
		-	-	-0.35		I _C = -500mA, I _B = -20mA
		-	-	-0.50		I _C = -1A, I _B = -100mA
Base-Emitter Saturation Voltage (Note 4)	V _{BE(sat)}	-	-	-1.1	V	I _C = -1A, I _B = -100mA
Base-Emitter Turn-on Voltage (Note 4)	V _{BE(on)}	-	-	-1.0	V	I _C = -1A, V _{CE} = -5V
Transitional Frequency	f _T	150	300	-	MHz	I _C = -50mA, V _{CE} = -10V, f = 100MHz
Output capacitance	C _{obo}	-	-	10	pF	V _{CB} = -10V, f = 1MHz,
Switching Time	Delay Time	t _(d)	-	34.9	ns	V _{CC} = -10V, I _C = -500mA, I _{B1} = -I _{B2} = 25mA
	Rise Time	t _(r)	-	19.2		
	Storage Time	t _(s)	-	249		
	Fall Time	t _(f)	-	62		

Notes: 4. Measured under pulsed conditions. Pulse width = 300μs. Duty cycle ≤2%.

Typical Characteristics

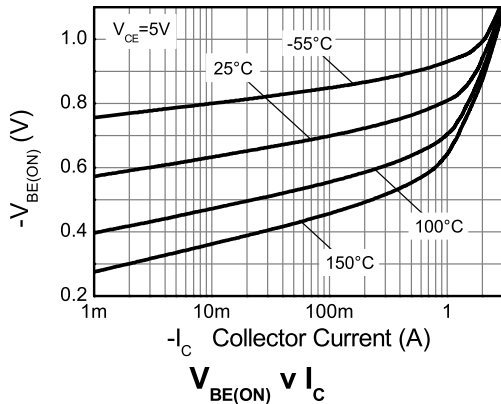
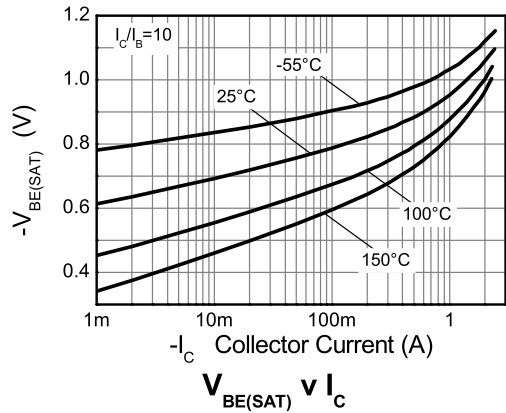
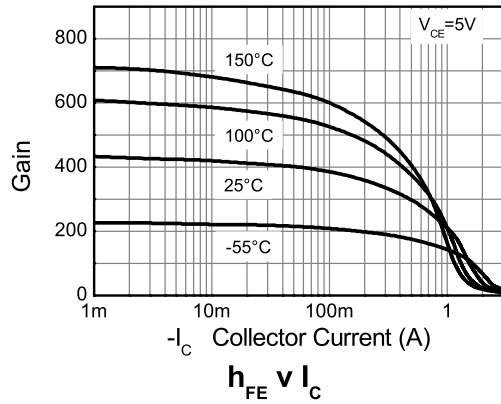
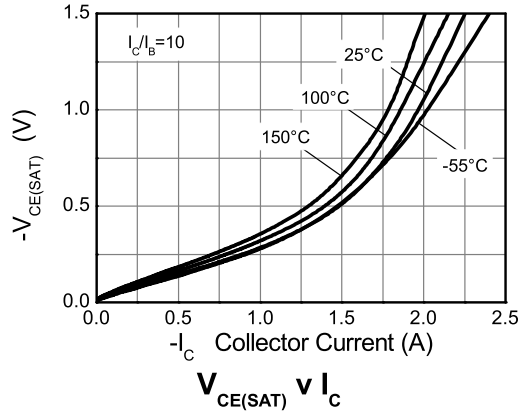
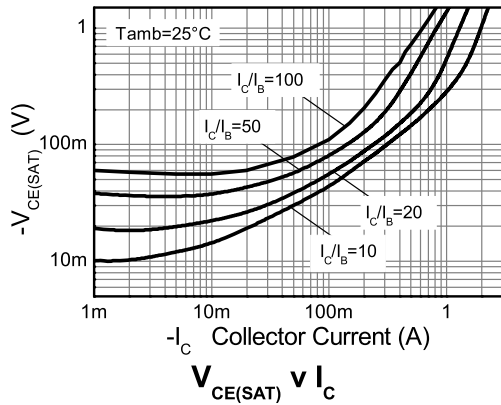

Package Outline Dimensions

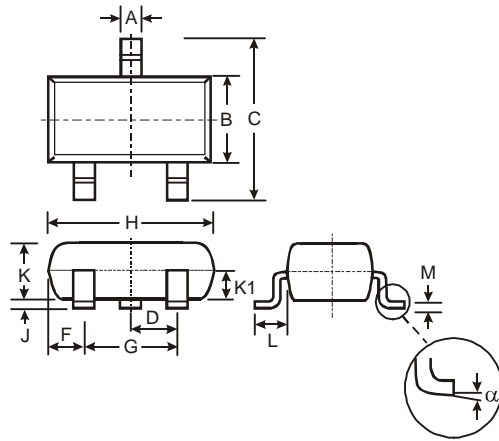

SOT23			
Dim	Min	Max	Typ
A	0.37	0.51	0.40
B	1.20	1.40	1.30
C	2.30	2.50	2.40
D	0.89	1.03	0.915
F	0.45	0.60	0.535
G	1.78	2.05	1.83
H	2.80	3.00	2.90
J	0.013	0.10	0.05
K	0.903	1.10	1.00
K1	-	-	0.400
L	0.45	0.61	0.55
M	0.085	0.18	0.11
α	0°	8°	-
All Dimensions in mm			

Suggested Pad Layout

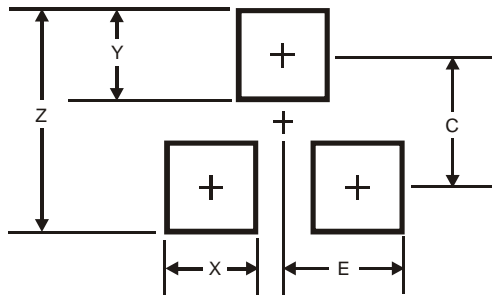

Dimensions	Value (in mm)
Z	2.9
X	0.8
Y	0.9
C	2.0
E	1.35

IMPORTANT NOTICE

DIODES INCORPORATED MAKES NO WARRANTY OF ANY KIND, EXPRESS OR IMPLIED, WITH REGARDS TO THIS DOCUMENT, INCLUDING, BUT NOT LIMITED TO, THE IMPLIED WARRANTIES OF MERCHANTABILITY AND FITNESS FOR A PARTICULAR PURPOSE (AND THEIR EQUIVALENTS UNDER THE LAWS OF ANY JURISDICTION).

Diodes Incorporated and its subsidiaries reserve the right to make modifications, enhancements, improvements, corrections or other changes without further notice to this document and any product described herein. Diodes Incorporated does not assume any liability arising out of the application or use of this document or any product described herein; neither does Diodes Incorporated convey any license under its patent or trademark rights, nor the rights of others. Any Customer or user of this document or products described herein in such applications shall assume all risks of such use and will agree to hold Diodes Incorporated and all the companies whose products are represented on Diodes Incorporated website, harmless against all damages.

Diodes Incorporated does not warrant or accept any liability whatsoever in respect of any products purchased through unauthorized sales channel. Should Customers purchase or use Diodes Incorporated products for any unintended or unauthorized application, Customers shall indemnify and hold Diodes Incorporated and its representatives harmless against all claims, damages, expenses, and attorney fees arising out of, directly or indirectly, any claim of personal injury or death associated with such unintended or unauthorized application.

Products described herein may be covered by one or more United States, international or foreign patents pending. Product names and markings noted herein may also be covered by one or more United States, international or foreign trademarks.

LIFE SUPPORT

Diodes Incorporated products are specifically not authorized for use as critical components in life support devices or systems without the express written approval of the Chief Executive Officer of Diodes Incorporated. As used herein:

A. Life support devices or systems are devices or systems which:

1. are intended to implant into the body, or
2. support or sustain life and whose failure to perform when properly used in accordance with instructions for use provided in the labeling can be reasonably expected to result in significant injury to the user.

B. A critical component is any component in a life support device or system whose failure to perform can be reasonably expected to cause the failure of the life support device or to affect its safety or effectiveness.

Customers represent that they have all necessary expertise in the safety and regulatory ramifications of their life support devices or systems, and acknowledge and agree that they are solely responsible for all legal, regulatory and safety-related requirements concerning their products and any use of Diodes Incorporated products in such safety-critical, life support devices or systems, notwithstanding any devices- or systems-related information or support that may be provided by Diodes Incorporated. Further, Customers must fully indemnify Diodes Incorporated and its representatives against any damages arising out of the use of Diodes Incorporated products in such safety-critical, life support devices or systems.

Copyright © 2010, Diodes Incorporated

www.diodes.com



Компания «ЭлектроПласт» предлагает заключение долгосрочных отношений при поставках импортных электронных компонентов на взаимовыгодных условиях!

Наши преимущества:

- Оперативные поставки широкого спектра электронных компонентов отечественного и импортного производства напрямую от производителей и с крупнейших мировых складов;
- Поставка более 17-ти миллионов наименований электронных компонентов;
- Поставка сложных, дефицитных, либо снятых с производства позиций;
- Оперативные сроки поставки под заказ (от 5 рабочих дней);
- Экспресс доставка в любую точку России;
- Техническая поддержка проекта, помощь в подборе аналогов, поставка прототипов;
- Система менеджмента качества сертифицирована по Международному стандарту ISO 9001;
- Лицензия ФСБ на осуществление работ с использованием сведений, составляющих государственную тайну;
- Поставка специализированных компонентов (Xilinx, Altera, Analog Devices, Intersil, Interpoint, Microsemi, Aeroflex, Peregrine, Syfer, Eurofarad, Texas Instrument, Miteq, Cobham, E2V, MA-COM, Hittite, Mini-Circuits, General Dynamics и др.);

Помимо этого, одним из направлений компании «ЭлектроПласт» является направление «Источники питания». Мы предлагаем Вам помощь Конструкторского отдела:

- Подбор оптимального решения, техническое обоснование при выборе компонента;
- Подбор аналогов;
- Консультации по применению компонента;
- Поставка образцов и прототипов;
- Техническая поддержка проекта;
- Защита от снятия компонента с производства.



Как с нами связаться

Телефон: 8 (812) 309 58 32 (многоканальный)

Факс: 8 (812) 320-02-42

Электронная почта: org@eplast1.ru

Адрес: 198099, г. Санкт-Петербург, ул. Калинина, дом 2, корпус 4, литера А.