

# Cree® XLamp® CXA2530 LED



## PRODUCT DESCRIPTION

The XLamp CXA2530 LED array expands Cree’s family of high-flux, multi-die arrays, offering high performance in an easy-to-use platform. With XLamp lighting-class reliability, the CXA2530’s uniform emitting surface enables both directional and non-directional lighting applications and luminaire designs. Available in 2-step and 4-step color consistency, and featuring a 19-mm optical source, the CXA2530 brings new levels of flux and efficacy to this form factor.

## FEATURES

- Available in ANSI white bins as well as 4-step and 2-step EasyWhite bins at 2700 K, 3000 K, 3500 K, 4000 K and 5000 K CCT
- 80 and 90 minimum CRI options
- Forward voltage: 37 V
- 85 °C binning and characterization
- Maximum drive current: 1500 mA
- 115° viewing angle, uniform chromaticity profile
- Top-side solder connections
- Thermocouple attach point
- NEMA SSL-3 2011 standard flux bins
- UL-recognized component (E349212)



## TABLE OF CONTENTS

|  |    |
|--|----|
| Characteristics .....  | 2  |
| Flux Characteristics, Standard Order Codes and Bins .....        | 2  |
| Flux Characteristics, Standard Order Codes and Bins, 90 CRI..... | 4  |
| Flux Characteristics, Standard Order Codes and Bins, 80 CRI..... | 5  |
| Relative Spectral Power Distribution .                           | 6  |
| Relative Luminous Flux vs. Junction Temperature .....            | 6  |
| Electrical Characteristics.....                                  | 7  |
| Relative Luminous Flux vs. Current ..                            | 7  |
| Relative Chromaticity vs. Current and Temperature .....          | 8  |
| Typical Spatial Distribution.....                                | 9  |
| Performance Groups - Brightness.....                             | 9  |
| Performance Groups - Chromaticity.10                             |    |
| Cree EasyWhite Bins Plotted on the 1931 CIE Color Space .....    | 11 |
| Cree ANSI White Bins Plotted on the 1931 CIE Color Space .....   | 12 |
| Bin and Order Code Formats .....                                 | 13 |
| Mechanical Dimensions.....                                       | 13 |
| Notes.....   | 14 |
| Packaging.....   | 15 |

**CHARACTERISTICS**

| Characteristics                                | Unit    | Minimum | Typical | Maximum |
|--|---------|---------|---------|---------|
| Effective thermal resistance, junction to case | °C/W    |         | 0.8     |         |
| Viewing angle (FWHM)                           | degrees |         | 115     |         |
| ESD classification (HBM per Mil-Std-883D)      |         |         | Class 2 |         |
| DC forward current                             | mA      |         | 800     | 1500    |
| Reverse current                                | mA      |         |         | 0.1     |
| Forward voltage (@ 800 mA, 85 °C)              | V       |         | 37      |         |
| Forward voltage (@ 800 mA, 25 °C)              | V       |         | 37.9    | 42      |
| LED junction temperature                       | °C      |         |         | 150     |
| Temperature coefficient of voltage             | mV/°C   |         | -14.6   |         |

**FLUX CHARACTERISTICS, STANDARD ORDER CODES AND BINS ( $I_f = 800 \text{ mA}$ ,  $T_j = 85 \text{ °C}$ )**

The following tables provide order codes for XLamp CXA2530 LEDs. For a complete description of the order code nomenclature, please reference Bin and Order Code Formats (page 13).

| Color     | CCT Range | Base Order Codes<br>Min. Luminous Flux<br>@ 800 mA |                   |                    | 2-Step Order Code   |                          | 4-Step Order Code   |                          |
|-----------|-----------|--|-------------------|--------------------|---------------------|--------------------------|---------------------|--------------------------|
|           |           | Group  | Flux (lm) @ 85 °C | Flux (lm) @ 25 °C* | Chromaticity Region |                          | Chromaticity Region |                          |
| EasyWhite | 5000K     | T4   | 3440              | 3879               | 50H                 | CXA2530-0000-000N00T450H | 50F                 | CXA2530-0000-000N00T450F |
|           |           | U2   | 3680              | 4150               |                     | CXA2530-0000-000N00U250H |                     | CXA2530-0000-000N00U250F |
|           | 4000K     | T2   | 3200              | 3609               | 40H                 | CXA2530-0000-000N00T240H | 40F                 | CXA2530-0000-000N00T240F |
|           |           | T4   | 3440              | 3879               |                     | CXA2530-0000-000N00T440H |                     | CXA2530-0000-000N00T440F |
|           |           | U2   | 3680              | 4150               |                     | CXA2530-0000-000N00U240H |                     | CXA2530-0000-000N00U240F |
|           | 3500K     | S4   | 2990              | 3372               | 35H                 | CXA2530-0000-000N00S435H | 35F                 | CXA2530-0000-000N00S435F |
|           |           | T2   | 3200              | 3609               |                     | CXA2530-0000-000N00T235H |                     | CXA2530-0000-000N00T235F |
|           |           | T4   | 3440              | 3879               |                     | CXA2530-0000-000N00T435H |                     | CXA2530-0000-000N00T435F |
|           | 3000K     | S4   | 2990              | 3372               | 30H                 | CXA2530-0000-000N00S430H | 30F                 | CXA2530-0000-000N00S430F |
|           |           | T2   | 3200              | 3609               |                     | CXA2530-0000-000N00T230H |                     | CXA2530-0000-000N00T230F |
|           | 2700K     | S2   | 2780              | 3135               | 27H                 | CXA2530-0000-000N00S227H | 27F                 | CXA2530-0000-000N00S227F |
|           |           | S4   | 2990              | 3372               |                     | CXA2530-0000-000N00S427H |                     | CXA2530-0000-000N00S427F |
|           |           | T2   | 3200              | 3609               |                     | CXA2530-0000-000N00T227H |                     | CXA2530-0000-000N00T227F |

**Notes:**

- Cree maintains a tolerance of  $\pm 7\%$  on flux and power measurements,  $\pm 0.005$  on chromaticity (CCx, CCy) measurements and a tolerance of  $\pm 2$  on CRI measurements.
- Minimum CRI for standard color temperatures 0E8, 27F, 27H, 0E7, 30F, 30H, 0E6, 35F, 35H is 80.
- Minimum CRI for standard color temperatures 0E5, 40F, 40H, 0E3, 50F, 50H is 70.
- Typical CRI for standard color temperatures 0E5, 40F, 40H, 0E3, 50F, 50H is 75.
- \* Flux values @ 25 °C are calculated and for reference only.

**FLUX CHARACTERISTICS, STANDARD ORDER CODES AND BINS ( $I_F = 800 \text{ mA}$ ,  $T_J = 85 \text{ }^\circ\text{C}$ ) - CONTINUED**

| Color      | CCT Range | Base Order Codes<br>Min. Luminous Flux<br>@ 800 mA |                      |                       | Chromaticity Regions | Order Code               |
|------------|-----------|--|----------------------|-----------------------|----------------------|--------------------------|
|            |           | Group  | Flux (lm)<br>@ 85 °C | Flux (lm)<br>@ 25 °C* |                      |                          |
| ANSI White | 5000K     | T4   | 3440                 | 3879                  | 3A0, 3B0, 3C0, 3D0   | CXA2530-0000-000N00T40E3 |
|            |           | U2   | 3680                 | 4150                  |                      | CXA2530-0000-000N00U20E3 |
|            | 4000K     | T2   | 3200                 | 3609                  | 5A0, 5B0, 5C0, 5D0   | CXA2530-0000-000N00T20E5 |
|            |           | T4   | 3440                 | 3879                  |                      | CXA2530-0000-000N00T40E5 |
|            |           | U2   | 3680                 | 4150                  |                      | CXA2530-0000-000N00U20E5 |
|            | 3500K     | S4   | 2990                 | 3372                  | 6A0, 6B0, 6C0, 6D0   | CXA2530-0000-000N00S40E6 |
|            |           | T2   | 3200                 | 3609                  |                      | CXA2530-0000-000N00T20E6 |
|            |           | T4   | 3440                 | 3879                  |                      | CXA2530-0000-000N00T40E6 |
|            | 3000K     | S4   | 2990                 | 3372                  | 7A0, 7B0, 7C0, 7D0   | CXA2530-0000-000N00S40E7 |
|            |           | T2   | 3200                 | 3609                  |                      | CXA2530-0000-000N00T20E7 |
|            | 2700K     | S2   | 2780                 | 3135                  | 8A0, 8B0, 8C0, 8D0   | CXA2530-0000-000N00S20E8 |
|            |           | S4   | 2990                 | 3372                  |                      | CXA2530-0000-000N00S40E8 |
|            |           | T2   | 3200                 | 3609                  |                      | CXA2530-0000-000N00T20E8 |

**Notes:**

- Cree maintains a tolerance of  $\pm 7\%$  on flux and power measurements,  $\pm 0.005$  on chromaticity (CCx, CCy) measurements and a tolerance of  $\pm 2$  on CRI measurements.
- Minimum CRI for standard color temperatures 0E8, 27F, 27H, 0E7, 30F, 30H, 0E6, 35F, 35H is 80.
- Minimum CRI for standard color temperatures 0E5, 40F, 40H, 0E3, 50F, 50H is 70.
- Typical CRI for standard color temperatures 0E5, 40F, 40H, 0E3, 50F, 50H is 75.
- \* Flux values @ 25 °C are calculated and for reference only.

**FLUX CHARACTERISTICS, STANDARD ORDER CODES AND BINS, 90 CRI ( $I_F = 800 \text{ mA}$ ,  $T_j = 85 \text{ }^\circ\text{C}$ )**

The following tables provide order codes for XLamp CXA2530 90 CRI minimum LEDs. For a complete description of the order code nomenclature, please reference Bin and Order Code Formats (page 13).

| Color     | CCT Range | Base Order Codes<br>Min. Luminous Flux<br>@ 800 mA |                   |                    | 2-Step Order Code   |                          | 4-Step Order Code   |                          |
|-----------|-----------|--|-------------------|--------------------|---------------------|--------------------------|---------------------|--------------------------|
|           |           | Group  | Flux (lm) @ 85 °C | Flux (lm) @ 25 °C* | Chromaticity Region |                          | Chromaticity Region |                          |
| EasyWhite | 3000K     | Q4   | 2260              | 2549               | 30H                 | CXA2530-0000-000N0UQ430H | 30F                 | CXA2530-0000-000N0UQ430F |
|           |           | R2   | 2420              | 2729               |                     | CXA2530-0000-000N0UR230H |                     | CXA2530-0000-000N0UR230F |
|           |           | R4   | 2600              | 2932               |                     | CXA2530-0000-000N0UR430H |                     | CXA2530-0000-000N0UR430F |
|           | 2700K     | Q2   | 2100              | 2368               | 27H                 | CXA2530-0000-000N0UQ227H | 27F                 | CXA2530-0000-000N0UQ227F |
|           |           | Q4   | 2260              | 2549               |                     | CXA2530-0000-000N0UQ427H |                     | CXA2530-0000-000N0UQ427F |

| Color      | CCT Range | Base Order Codes<br>Min. Luminous Flux<br>@ 800 mA |                   |                    | Chromaticity Regions | Order Code               |
|------------|-----------|--|-------------------|--------------------|----------------------|--------------------------|
|            |           | Group  | Flux (lm) @ 85 °C | Flux (lm) @ 25 °C* |                      |                          |
| ANSI White | 3000K     | Q4   | 2260              | 2549               | 7A0, 7B0, 7C0, 7D0   | CXA2530-0000-000N0UQ40E7 |
|            |           | R2   | 2420              | 2729               |                      | CXA2530-0000-000N0UR20E7 |
|            |           | R4   | 2600              | 2932               |                      | CXA2530-0000-000N0UR40E7 |
|            | 2700K     | Q2   | 2100              | 2368               | 8A0, 8B0, 8C0, 8D0   | CXA2530-0000-000N0UQ20E8 |
|            |           | Q4   | 2260              | 2549               |                      | CXA2530-0000-000N0UQ40E8 |

**Notes:**

- Cree maintains a tolerance of  $\pm 7\%$  on flux and power measurements,  $\pm 0.005$  on chromaticity (CCx, CCy) measurements and a tolerance of  $\pm 2$  on CRI measurements.
- Minimum CRI for high CRI color temperatures 0E8, 27F, 27H, 0E7, 30F, 30H is 90.
- \* Flux values @ 25 °C are calculated and for reference only.

**FLUX CHARACTERISTICS, STANDARD ORDER CODES AND BINS, 80 CRI ( $I_F = 800 \text{ mA}$ ,  $T_j = 85 \text{ }^\circ\text{C}$ )**

The following tables provide order codes for XLamp CXA2530 80 CRI minimum LEDs. For a complete description of the order code nomenclature, please reference Bin and Order Code Formats (page 13).

| Color     | CCT Range | Base Order Codes<br>Min. Luminous Flux<br>@ 800 mA |                   |                    | 2-Step Order Code   |                          | 4-Step Order Code   |                          |
|-----------|-----------|--|-------------------|--------------------|---------------------|--------------------------|---------------------|--------------------------|
|           |           | Group  | Flux (lm) @ 85 °C | Flux (lm) @ 25 °C* | Chromaticity Region |                          | Chromaticity Region |                          |
| EasyWhite | 5000K     | S4   | 2990              | 3372               | 50H                 | CXA2530-0000-000N0HS450H | 50F                 | CXA2530-0000-000N0HS450F |
|           |           | T2   | 3200              | 3609               |                     | CXA2530-0000-000N0HT250H |                     | CXA2530-0000-000N0HT250F |
|           |           | T4   | 3440              | 3879               |                     | CXA2530-0000-000N0HT450H |                     | CXA2530-0000-000N0HT450F |
|           | 4000K     | S4   | 2990              | 3372               | 40H                 | CXA2530-0000-000N0HS440H | 40F                 | CXA2530-0000-000N0HS440F |
|           |           | T2   | 3200              | 3609               |                     | CXA2530-0000-000N0HT240H |                     | CXA2530-0000-000N0HT240F |

| Color      | CCT Range | Base Order Codes<br>Min Luminous Flux<br>@ 800 mA |                   |                    | Chromaticity Regions | Order Code               |
|------------|-----------|---|-------------------|--------------------|----------------------|--------------------------|
|            |           | Group   | Flux (lm) @ 85 °C | Flux (lm) @ 25 °C* |                      |                          |
| ANSI White | 5000K     | S4  | 2990              | 3372               | 3A0, 3B0, 3C0, 3D0   | CXA2530-0000-000N0HS40E3 |
|            |           | T2  | 3200              | 3609               |                      | CXA2530-0000-000N0HT20E3 |
|            |           | T4  | 3440              | 3879               |                      | CXA2530-0000-000N0HT40E3 |
|            | 4000K     | S4  | 2990              | 3372               | 5A0, 5B0, 5C0, 5D0   | CXA2530-0000-000N0HS40E5 |
|            |           | T2  | 3200              | 3609               |                      | CXA2530-0000-000N0HT20E5 |

**Notes:**

- Cree maintains a tolerance of  $\pm 7\%$  on flux and power measurements,  $\pm 0.005$  on chromaticity (CCx, CCy) measurements and a tolerance of  $\pm 2$  on CRI measurements.
- Minimum CRI for high CRI color temperatures 0E5, 40F, 40H, 0E3, 50F, 50H is 80.
- \* Flux values @ 25 °C are calculated and for reference only.

**RELATIVE SPECTRAL POWER DISTRIBUTION ( $I_F = 800 \text{ mA}$ ,  $T_J = 85 \text{ }^\circ\text{C}$ )**

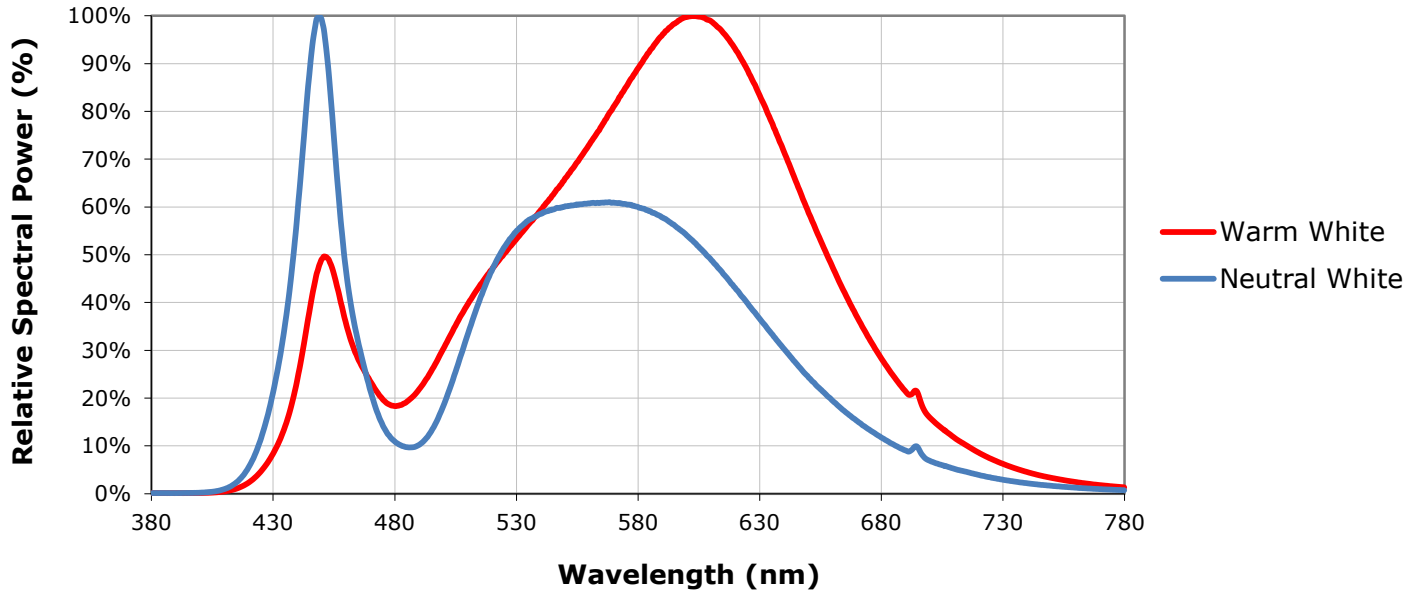

**RELATIVE LUMINOUS FLUX VS. JUNCTION TEMPERATURE ( $I_F = 800 \text{ mA}$ )**

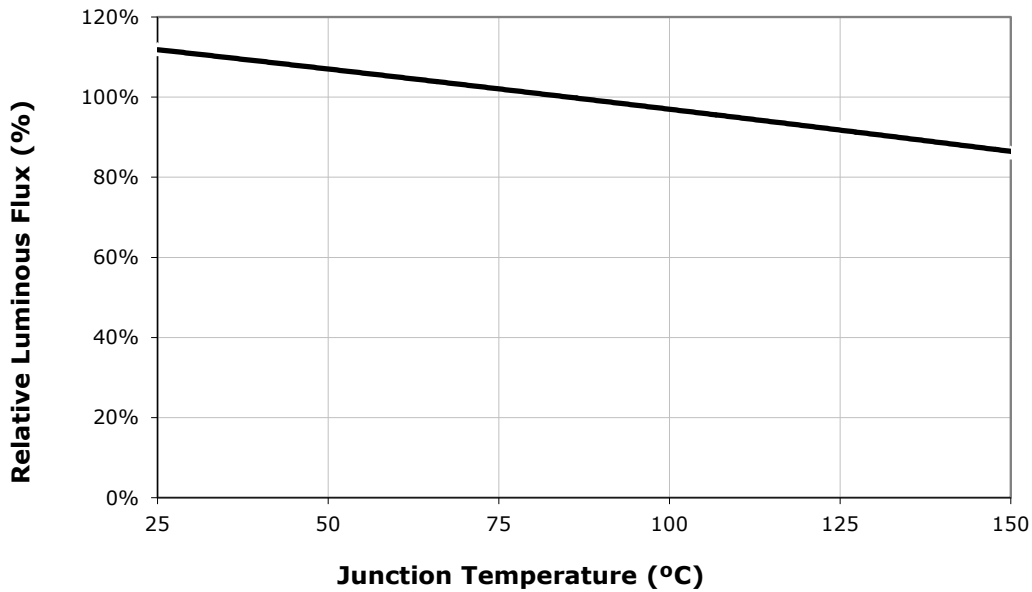

**ELECTRICAL CHARACTERISTICS ( $T_j = 85\text{ }^\circ\text{C}$ )**

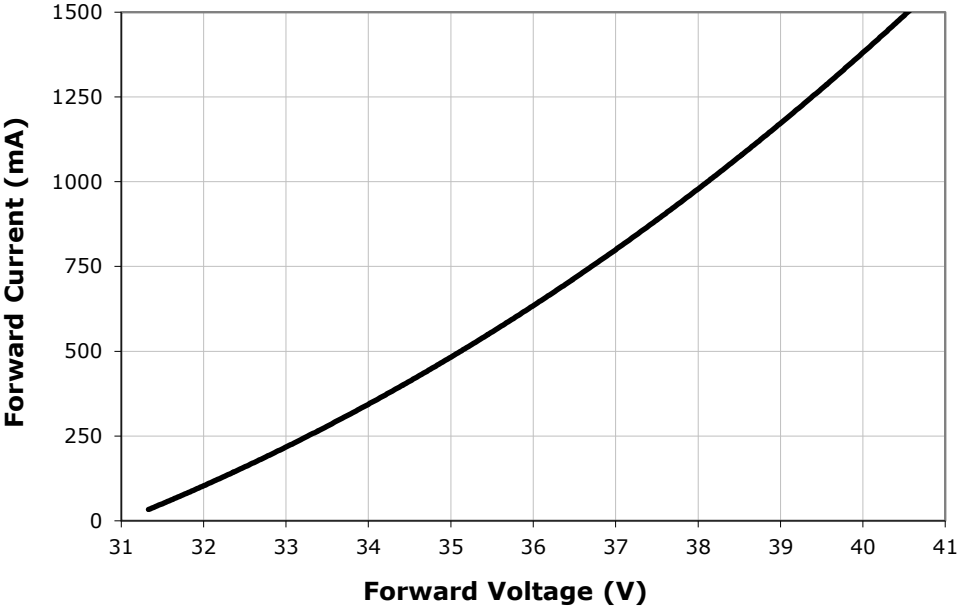

**RELATIVE LUMINOUS FLUX VS. CURRENT ( $T_j = 85\text{ }^\circ\text{C}$ )**

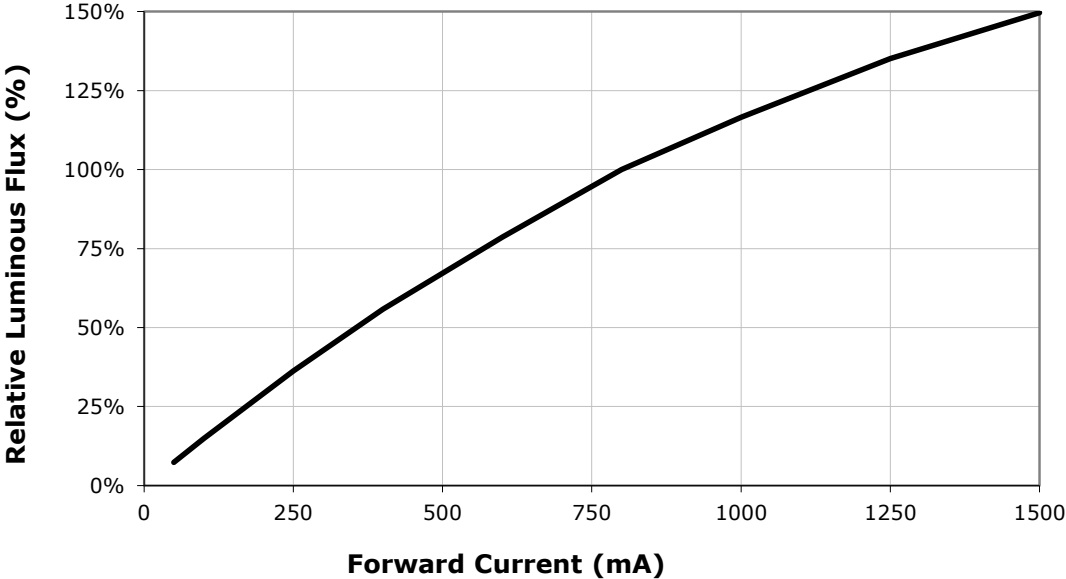

**RELATIVE CHROMATICITY VS. CURRENT AND TEMPERATURE (3000K, 80 CRI)**

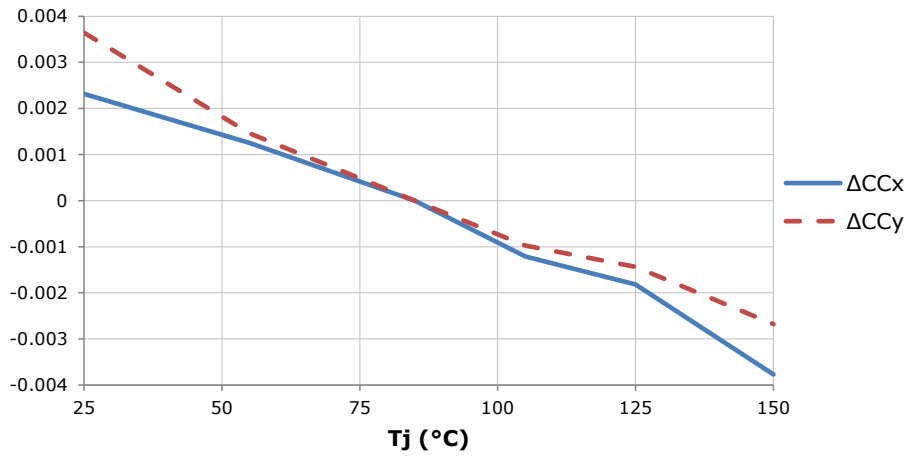
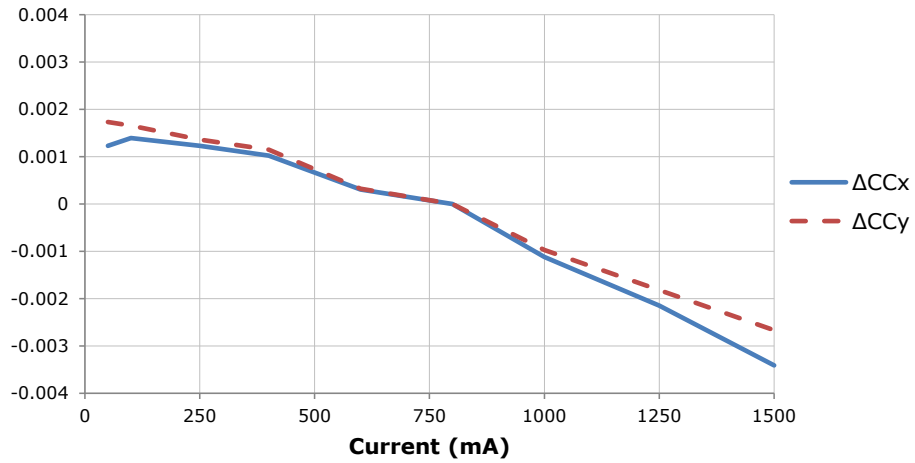



**TYPICAL SPATIAL DISTRIBUTION**

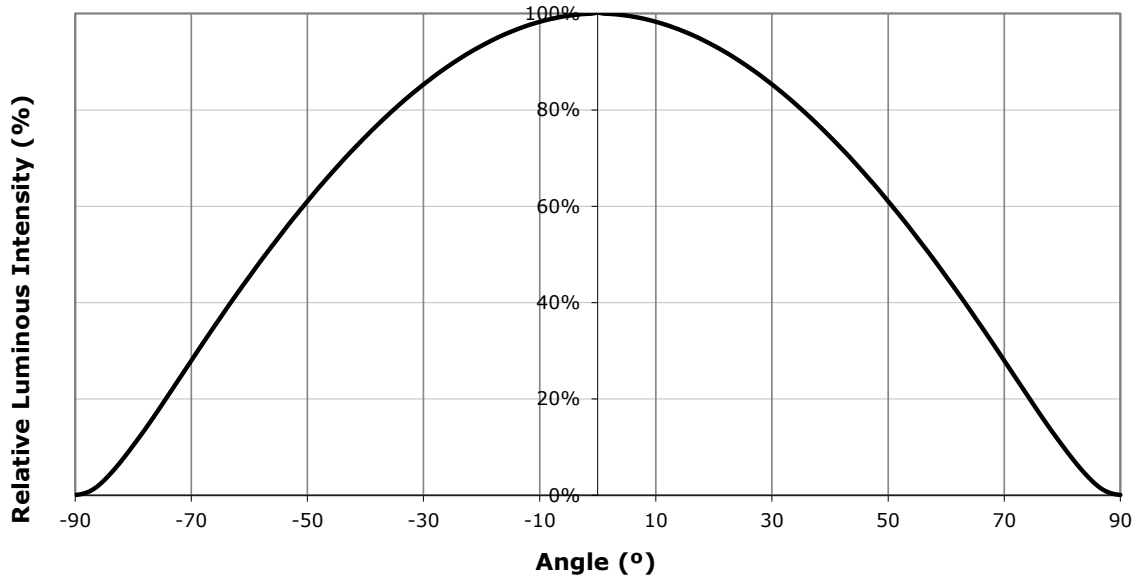

**PERFORMANCE GROUPS - BRIGHTNESS ( $I_f = 800 \text{ mA}$ ,  $T_j = 85 \text{ °C}$ )**

XLamp CXA2530 LEDs are tested for luminous flux and placed into one of the following bins.

| Group Code | Min. Luminous Flux @ 800 mA | Max. Luminous Flux @ 800 mA |
|------------|-----------------------------|-----------------------------|
| Q2         | 2100                        | 2260                        |
| Q4         | 2260                        | 2420                        |
| R2         | 2420                        | 2600                        |
| R4         | 2600                        | 2780                        |
| S2         | 2780                        | 2990                        |
| S4         | 2990                        | 3200                        |
| T2         | 3200                        | 3440                        |
| T4         | 3440                        | 3680                        |
| U2         | 3680                        | 3955                        |

**PERFORMANCE GROUPS - CHROMATICITY (T<sub>j</sub> = 85 °C)**

XLamp CXA2530 LEDs are tested for chromaticity and placed into one of the regions defined by the following bounding coordinates.

| EasyWhite Color Temperatures – 4-Step |       |        |        |
|---------------------------------------|-------|--------|--------|
| Code                                  | CCT   | x      | y      |
| 50F                                   | 5000K | 0.3407 | 0.3459 |
|                                       |       | 0.3415 | 0.3586 |
|                                       |       | 0.3499 | 0.3654 |
|                                       |       | 0.3484 | 0.3521 |
| 40F                                   | 4000K | 0.3744 | 0.3685 |
|                                       |       | 0.3782 | 0.3837 |
|                                       |       | 0.3912 | 0.3917 |
|                                       |       | 0.3863 | 0.3758 |
| 35F                                   | 3500K | 0.3981 | 0.3800 |
|                                       |       | 0.4040 | 0.3966 |
|                                       |       | 0.4186 | 0.4037 |
|                                       |       | 0.4116 | 0.3865 |
| 30F                                   | 3000K | 0.4242 | 0.3919 |
|                                       |       | 0.4322 | 0.4096 |
|                                       |       | 0.4449 | 0.4141 |
|                                       |       | 0.4359 | 0.3960 |
| 27F                                   | 2700K | 0.4475 | 0.3994 |
|                                       |       | 0.4573 | 0.4178 |
|                                       |       | 0.4695 | 0.4207 |
|                                       |       | 0.4589 | 0.4021 |

| EasyWhite Color Temperatures – 2-Step |       |        |        |
|---------------------------------------|-------|--------|--------|
| Code                                  | CCT   | x      | y      |
| 50H                                   | 5000K | 0.3429 | 0.3507 |
|                                       |       | 0.3434 | 0.3571 |
|                                       |       | 0.3475 | 0.3604 |
|                                       |       | 0.3469 | 0.3539 |
| 40H                                   | 4000K | 0.3784 | 0.3741 |
|                                       |       | 0.3804 | 0.3818 |
|                                       |       | 0.3867 | 0.3857 |
|                                       |       | 0.3844 | 0.3778 |
| 35H                                   | 3500K | 0.4030 | 0.3857 |
|                                       |       | 0.4061 | 0.3941 |
|                                       |       | 0.4132 | 0.3976 |
|                                       |       | 0.4099 | 0.3890 |
| 30H                                   | 3000K | 0.4291 | 0.3973 |
|                                       |       | 0.4333 | 0.4062 |
|                                       |       | 0.4395 | 0.4084 |
|                                       |       | 0.4351 | 0.3994 |
| 27H                                   | 2700K | 0.4528 | 0.4046 |
|                                       |       | 0.4578 | 0.4138 |
|                                       |       | 0.4638 | 0.4152 |
|                                       |       | 0.4586 | 0.4060 |

| ANSI White Bins |       |          |       |       |
|-----------------|-------|----------|-------|-------|
| Code            | CCT   | Bin Code | x     | y     |
| 0E3             | 5000K | 3A0      | .3371 | .3490 |
|                 |       |          | .3451 | .3554 |
|                 |       |          | .3440 | .3427 |
|                 |       |          | .3366 | .3369 |
|                 |       | 3B0      | .3376 | .3616 |
|                 |       |          | .3463 | .3687 |
|                 |       |          | .3451 | .3554 |
|                 |       |          | .3371 | .3490 |
|                 |       | 3C0      | .3463 | .3687 |
|                 |       |          | .3551 | .3760 |
|                 |       |          | .3533 | .3620 |
|                 |       |          | .3451 | .3554 |
|                 |       | 3D0      | .3451 | .3554 |
|                 |       |          | .3533 | .3620 |
|                 |       |          | .3515 | .3487 |
|                 |       |          | .3440 | .3427 |

| ANSI White Bins |       |          |       |       |
|-----------------|-------|----------|-------|-------|
| Code            | CCT   | Bin Code | x     | y     |
| 0E5             | 4000K | 5A0      | .3670 | .3578 |
|                 |       |          | .3702 | .3722 |
|                 |       |          | .3825 | .3798 |
|                 |       |          | .3783 | .3646 |
|                 |       | 5B0      | .3702 | .3722 |
|                 |       |          | .3736 | .3874 |
|                 |       |          | .3869 | .3958 |
|                 |       |          | .3825 | .3798 |
|                 |       | 5C0      | .3825 | .3798 |
|                 |       |          | .3869 | .3958 |
|                 |       |          | .4006 | .4044 |
|                 |       |          | .3950 | .3875 |
|                 |       | 5D0      | .3783 | .3646 |
|                 |       |          | .3825 | .3798 |
|                 |       |          | .3950 | .3875 |
|                 |       |          | .3898 | .3716 |

| ANSI White Bins |       |          |       |       |
|-----------------|-------|----------|-------|-------|
| Code            | CCT   | Bin Code | x     | y     |
| 0E6             | 3500K | 6A0      | .3889 | .3690 |
|                 |       |          | .3941 | .3848 |
|                 |       |          | .4080 | .3916 |
|                 |       |          | .4017 | .3751 |
|                 |       | 6B0      | .3941 | .3848 |
|                 |       |          | .3996 | .4015 |
|                 |       |          | .4146 | .4089 |
|                 |       |          | .4080 | .3916 |
|                 |       | 6C0      | .4080 | .3916 |
|                 |       |          | .4146 | .4089 |
|                 |       |          | .4299 | .4165 |
|                 |       |          | .4221 | .3984 |
|                 |       | 6D0      | .4017 | .3751 |
|                 |       |          | .4080 | .3916 |
|                 |       |          | .4221 | .3984 |
|                 |       |          | .4147 | .3814 |

| ANSI White Bins |       |          |       |       |
|-----------------|-------|----------|-------|-------|
| Code            | CCT   | Bin Code | x     | y     |
| 0E7             | 3000K | 7A0      | .4147 | .3814 |
|                 |       |          | .4221 | .3984 |
|                 |       |          | .4342 | .4028 |
|                 |       |          | .4259 | .3853 |
|                 |       | 7B0      | .4221 | .3984 |
|                 |       |          | .4299 | .4165 |
|                 |       |          | .4430 | .4212 |
|                 |       |          | .4342 | .4028 |
|                 |       | 7C0      | .4342 | .4028 |
|                 |       |          | .4430 | .4212 |
|                 |       |          | .4562 | .4260 |
|                 |       |          | .4465 | .4071 |
|                 |       | 7D0      | .4259 | .3853 |
|                 |       |          | .4342 | .4028 |
|                 |       |          | .4465 | .4071 |
|                 |       |          | .4373 | .3893 |

  

| ANSI White Bins |       |          |       |       |
|-----------------|-------|----------|-------|-------|
| Code            | CCT   | Bin Code | x     | y     |
| 0E8             | 2700K | 8A0      | .4373 | .3893 |
|                 |       |          | .4465 | .4071 |
|                 |       |          | .4582 | .4099 |
|                 |       |          | .4483 | .3919 |
|                 |       | 8B0      | .4465 | .4071 |
|                 |       |          | .4562 | .4260 |
|                 |       |          | .4687 | .4289 |
|                 |       |          | .4582 | .4099 |
|                 |       | 8C0      | .4582 | .4099 |
|                 |       |          | .4687 | .4289 |
|                 |       |          | .4813 | .4319 |
|                 |       |          | .4700 | .4126 |
|                 |       | 8D0      | .4483 | .3919 |
|                 |       |          | .4582 | .4099 |
|                 |       |          | .4700 | .4126 |
|                 |       |          | .4593 | .3944 |

**CREE EASYWHITE BINS PLOTTED ON THE 1931 CIE COLOR SPACE ( $T_j = 85^\circ\text{C}$ )**

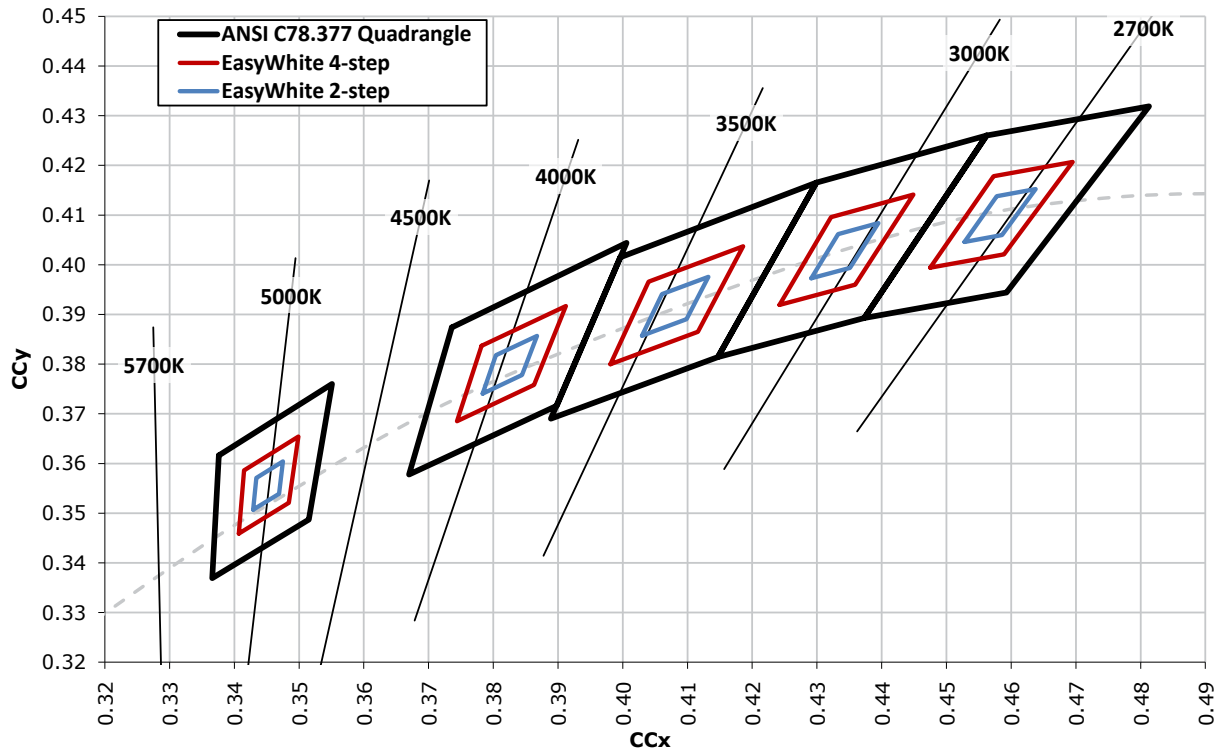

**CREE ANSI WHITE BINS PLOTTED ON THE 1931 CIE COLOR SPACE ( $T_j = 85^\circ\text{C}$ )**

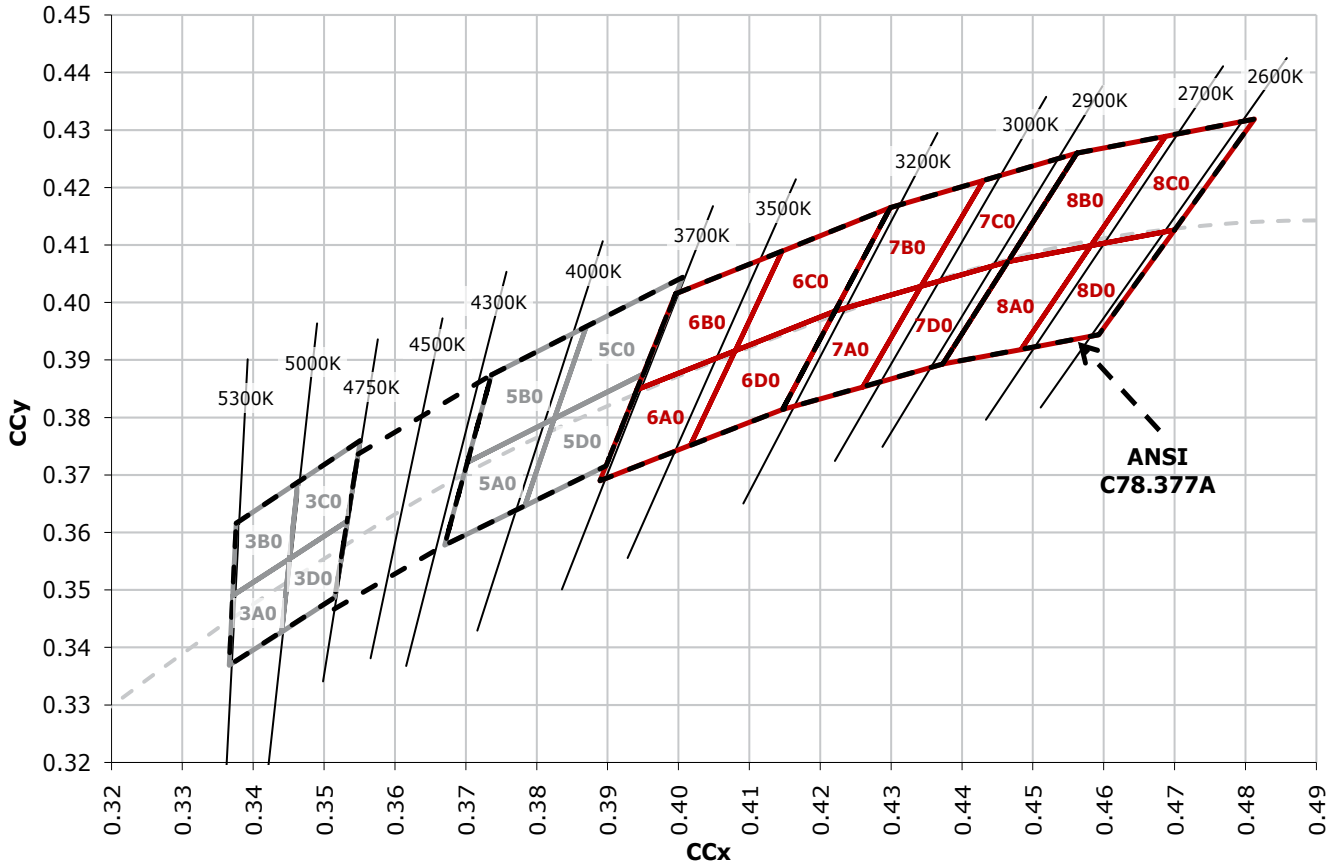

### BIN AND ORDER CODE FORMATS

Bin codes and order codes are configured as follows:

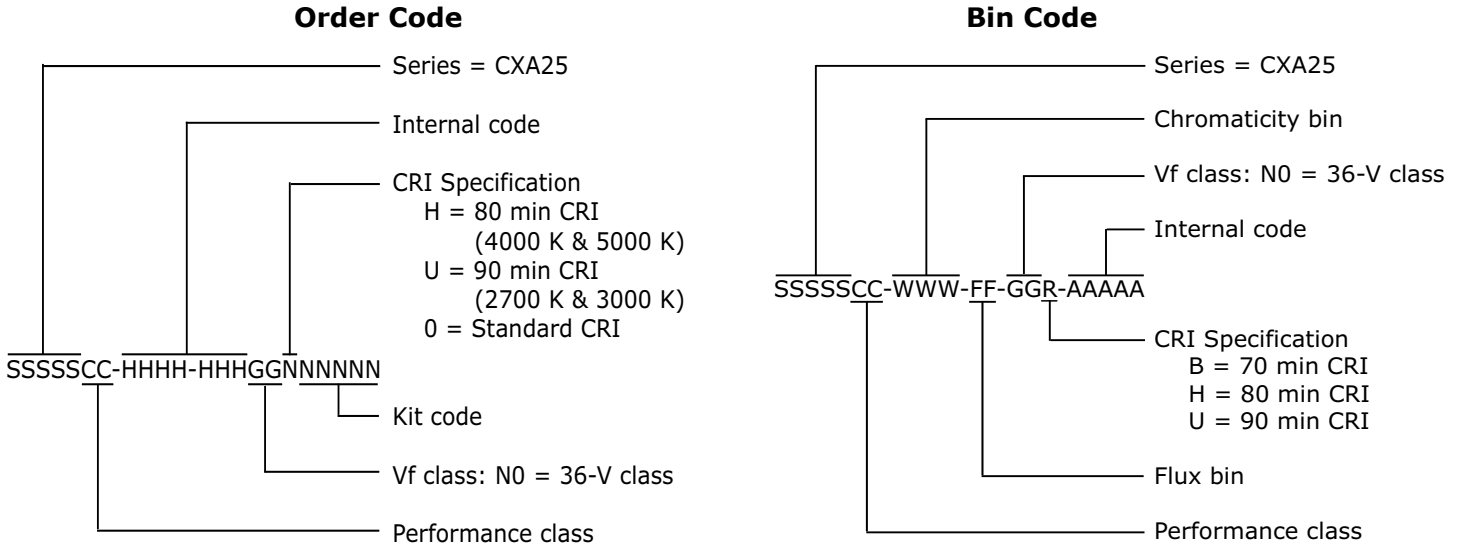

### MECHANICAL DIMENSIONS

Dimensions are in mm.

Tolerances unless otherwise

specified:

.x ± .10

.xx ± .03

.xxx ± .010

x° ± 1° x ± .10

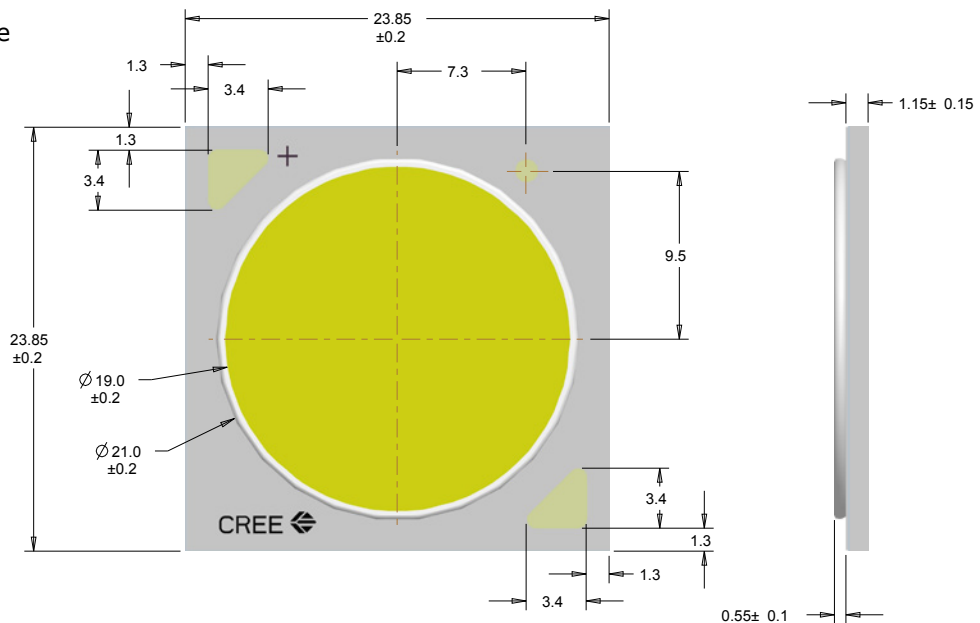

## NOTES

---

### **Lumen Maintenance Projections**

Cree now uses standardized IES LM-80-08 and TM-21-11 methods for collecting long-term data and extrapolating LED lumen maintenance. For information on the specific LM-80 data sets available for this LED, refer to the public LM-80 results document at [www.cree.com/xlamp\\_app\\_notes/LM80\\_results](http://www.cree.com/xlamp_app_notes/LM80_results).

Please read the XLamp Long-Term Lumen Maintenance application note at [www.cree.com/xlamp\\_app\\_notes/lumen\\_maintenance](http://www.cree.com/xlamp_app_notes/lumen_maintenance) for more details on Cree's lumen maintenance testing and forecasting. Please read the XLamp Thermal Management application note at [www.cree.com/xlamp\\_app\\_notes/thermal\\_management](http://www.cree.com/xlamp_app_notes/thermal_management) for details on how thermal design, ambient temperature, and drive current affect the LED junction temperature.

### **UL Recognized Component**

Level 4 enclosure consideration. The LED package or a portion thereof has been investigated as a fire and electrical enclosure per ANSI/UL 8750.

### **Vision Advisory Claim**

Users should be cautioned not to stare at the light of this LED product. The bright light can damage the eye.

**PACKAGING**

Cree CXA2530 LEDs are packaged in tubes of 20, which are then combined in boxes of 5 tubes, or 100 LEDs. Boxes of 100 LEDs are of the same performance bin.

Dimensions are in mm.  
Tolerances unless otherwise specified:  
.x ± .10  
.xx ± .03  
.xxx ± .010  
x° ± 1°

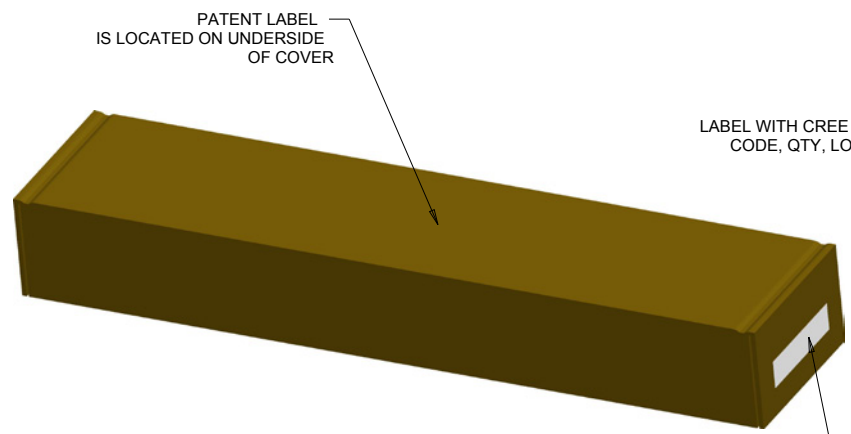
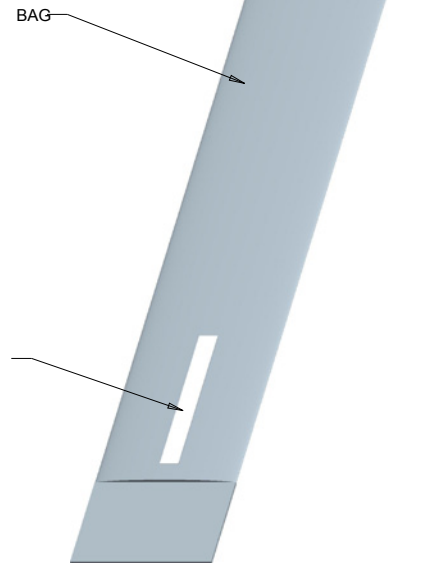
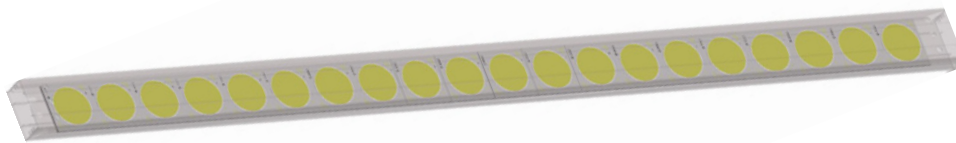
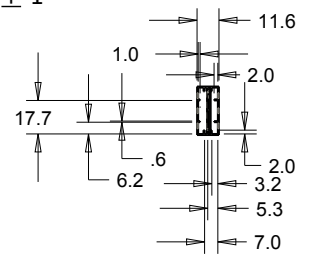
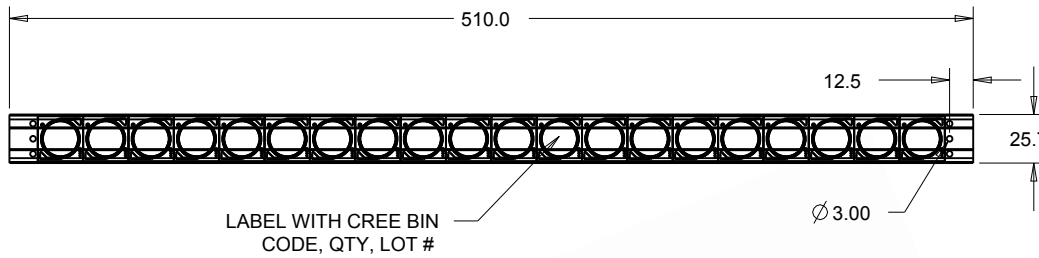

PATENT LABEL IS LOCATED ON UNDERSIDE OF COVER

LABEL WITH CREE BIN CODE, QTY, LOT #

LABEL WITH CREE BIN CODE, QTY, LOT #



Компания «ЭлектроПласт» предлагает заключение долгосрочных отношений при поставках импортных электронных компонентов на взаимовыгодных условиях!

Наши преимущества:

- Оперативные поставки широкого спектра электронных компонентов отечественного и импортного производства напрямую от производителей и с крупнейших мировых складов;
- Поставка более 17-ти миллионов наименований электронных компонентов;
- Поставка сложных, дефицитных, либо снятых с производства позиций;
- Оперативные сроки поставки под заказ (от 5 рабочих дней);
- Экспресс доставка в любую точку России;
- Техническая поддержка проекта, помощь в подборе аналогов, поставка прототипов;
- Система менеджмента качества сертифицирована по Международному стандарту ISO 9001;
- Лицензия ФСБ на осуществление работ с использованием сведений, составляющих государственную тайну;
- Поставка специализированных компонентов (Xilinx, Altera, Analog Devices, Intersil, Interpoint, Microsemi, Aeroflex, Peregrine, Syfer, Eurofarad, Texas Instrument, Miteq, Cobham, E2V, MA-COM, Hittite, Mini-Circuits, General Dynamics и др.);

Помимо этого, одним из направлений компании «ЭлектроПласт» является направление «Источники питания». Мы предлагаем Вам помощь Конструкторского отдела:

- Подбор оптимального решения, техническое обоснование при выборе компонента;
- Подбор аналогов;
- Консультации по применению компонента;
- Поставка образцов и прототипов;
- Техническая поддержка проекта;
- Защита от снятия компонента с производства.



#### Как с нами связаться

**Телефон:** 8 (812) 309 58 32 (многоканальный)

**Факс:** 8 (812) 320-02-42

**Электронная почта:** [org@eplast1.ru](mailto:org@eplast1.ru)

**Адрес:** 198099, г. Санкт-Петербург, ул. Калинина, дом 2, корпус 4, литера А.