

# Cree® XLamp® CXA2530 LED



## PRODUCT DESCRIPTION

The XLamp CXA2530 LED array expands Cree’s family of high-flux, multi-die arrays, offering high performance in an easy-to-use platform. With XLamp lighting-class reliability, the CXA2530’s uniform emitting surface enables both directional and non-directional lighting applications and luminaire designs. Available in 2-step and 4-step color consistency, and featuring a 19-mm optical source, the CXA2530 brings new levels of flux and efficacy to this form factor.

## FEATURES

- Available in ANSI white bins as well as 4-step and 2-step EasyWhite bins at 2700 K, 3000 K, 3500 K, 4000 K and 5000 K CCT
- 80 and 90 minimum CRI options
- Forward voltage: 37 V
- 85 °C binning and characterization
- Maximum drive current: 1500 mA
- 115° viewing angle, uniform chromaticity profile
- Top-side solder connections
- Thermocouple attach point
- NEMA SSL-3 2011 standard flux bins
- UL-recognized component (E349212)



## TABLE OF CONTENTS

Characteristics .....	2
Flux Characteristics, Standard Order Codes and Bins .....	2
Flux Characteristics, Standard Order Codes and Bins, 90 CRI.....	4
Flux Characteristics, Standard Order Codes and Bins, 80 CRI.....	5
Relative Spectral Power Distribution .	6
Relative Luminous Flux vs. Junction Temperature .....	6
Electrical Characteristics.....	7
Relative Luminous Flux vs. Current ..	7
Relative Chromaticity vs. Current and Temperature .....	8
Typical Spatial Distribution.....	9
Performance Groups - Brightness.....	9
Performance Groups - Chromaticity.10	
Cree EasyWhite Bins Plotted on the 1931 CIE Color Space .....	11
Cree ANSI White Bins Plotted on the 1931 CIE Color Space .....	12
Bin and Order Code Formats .....	13
Mechanical Dimensions.....	13
Notes.....	14
Packaging.....	15

## CHARACTERISTICS

Characteristics	Unit	Minimum	Typical	Maximum
Effective thermal resistance, junction to case	°C/W		0.8	
Viewing angle (FWHM)	degrees		115	
ESD classification (HBM per Mil-Std-883D)			Class 2	
DC forward current	mA		800	1500
Reverse current	mA			0.1
Forward voltage (@ 800 mA, 85 °C)	V		37	
Forward voltage (@ 800 mA, 25 °C)	V		37.9	42
LED junction temperature	°C			150
Temperature coefficient of voltage	mV/°C		-14.6	

## FLUX CHARACTERISTICS, STANDARD ORDER CODES AND BINS ( $I_f = 800 \text{ mA}$ , $T_j = 85 \text{ °C}$ )

The following tables provide order codes for XLamp CXA2530 LEDs. For a complete description of the order code nomenclature, please reference Bin and Order Code Formats (page 13).

Color	CCT Range	Base Order Codes Min. Luminous Flux @ 800 mA			2-Step Order Code		4-Step Order Code	
		Group	Flux (lm) @ 85 °C	Flux (lm) @ 25 °C*	Chromaticity Region		Chromaticity Region	
EasyWhite	5000K	T4	3440	3879	50H	CXA2530-0000-000N00T450H	50F	CXA2530-0000-000N00T450F
		U2	3680	4150		CXA2530-0000-000N00U250H		CXA2530-0000-000N00U250F
	4000K	T2	3200	3609	40H	CXA2530-0000-000N00T240H	40F	CXA2530-0000-000N00T240F
		T4	3440	3879		CXA2530-0000-000N00T440H		CXA2530-0000-000N00T440F
		U2	3680	4150		CXA2530-0000-000N00U240H		CXA2530-0000-000N00U240F
	3500K	S4	2990	3372	35H	CXA2530-0000-000N00S435H	35F	CXA2530-0000-000N00S435F
		T2	3200	3609		CXA2530-0000-000N00T235H		CXA2530-0000-000N00T235F
		T4	3440	3879		CXA2530-0000-000N00T435H		CXA2530-0000-000N00T435F
	3000K	S4	2990	3372	30H	CXA2530-0000-000N00S430H	30F	CXA2530-0000-000N00S430F
		T2	3200	3609		CXA2530-0000-000N00T230H		CXA2530-0000-000N00T230F
	2700K	S2	2780	3135	27H	CXA2530-0000-000N00S227H	27F	CXA2530-0000-000N00S227F
		S4	2990	3372		CXA2530-0000-000N00S427H		CXA2530-0000-000N00S427F
		T2	3200	3609		CXA2530-0000-000N00T227H		CXA2530-0000-000N00T227F

### Notes:

- Cree maintains a tolerance of  $\pm 7\%$  on flux and power measurements,  $\pm 0.005$  on chromaticity (CCx, CCy) measurements and a tolerance of  $\pm 2$  on CRI measurements.
- Minimum CRI for standard color temperatures 0E8, 27F, 27H, 0E7, 30F, 30H, 0E6, 35F, 35H is 80.
- Minimum CRI for standard color temperatures 0E5, 40F, 40H, 0E3, 50F, 50H is 70.
- Typical CRI for standard color temperatures 0E5, 40F, 40H, 0E3, 50F, 50H is 75.
- \* Flux values @ 25 °C are calculated and for reference only.

**FLUX CHARACTERISTICS, STANDARD ORDER CODES AND BINS ( $I_F = 800 \text{ mA}$ ,  $T_J = 85 \text{ }^\circ\text{C}$ ) - CONTINUED**

Color	CCT Range	Base Order Codes Min. Luminous Flux @ 800 mA			Chromaticity Regions	Order Code
		Group	Flux (lm) @ 85 °C	Flux (lm) @ 25 °C*		
ANSI White	5000K	T4	3440	3879	3A0, 3B0, 3C0, 3D0	CXA2530-0000-000N00T40E3
		U2	3680	4150		CXA2530-0000-000N00U20E3
	4000K	T2	3200	3609	5A0, 5B0, 5C0, 5D0	CXA2530-0000-000N00T20E5
		T4	3440	3879		CXA2530-0000-000N00T40E5
		U2	3680	4150		CXA2530-0000-000N00U20E5
	3500K	S4	2990	3372	6A0, 6B0, 6C0, 6D0	CXA2530-0000-000N00S40E6
		T2	3200	3609		CXA2530-0000-000N00T20E6
		T4	3440	3879		CXA2530-0000-000N00T40E6
	3000K	S4	2990	3372	7A0, 7B0, 7C0, 7D0	CXA2530-0000-000N00S40E7
		T2	3200	3609		CXA2530-0000-000N00T20E7
	2700K	S2	2780	3135	8A0, 8B0, 8C0, 8D0	CXA2530-0000-000N00S20E8
		S4	2990	3372		CXA2530-0000-000N00S40E8
		T2	3200	3609		CXA2530-0000-000N00T20E8

**Notes:**

- Cree maintains a tolerance of  $\pm 7\%$  on flux and power measurements,  $\pm 0.005$  on chromaticity (CCx, CCy) measurements and a tolerance of  $\pm 2$  on CRI measurements.
- Minimum CRI for standard color temperatures 0E8, 27F, 27H, 0E7, 30F, 30H, 0E6, 35F, 35H is 80.
- Minimum CRI for standard color temperatures 0E5, 40F, 40H, 0E3, 50F, 50H is 70.
- Typical CRI for standard color temperatures 0E5, 40F, 40H, 0E3, 50F, 50H is 75.
- \* Flux values @ 25 °C are calculated and for reference only.

**FLUX CHARACTERISTICS, STANDARD ORDER CODES AND BINS, 90 CRI ( $I_F = 800 \text{ mA}$ ,  $T_j = 85 \text{ }^\circ\text{C}$ )**

The following tables provide order codes for XLamp CXA2530 90 CRI minimum LEDs. For a complete description of the order code nomenclature, please reference Bin and Order Code Formats (page 13).

Color	CCT Range	Base Order Codes Min. Luminous Flux @ 800 mA			2-Step Order Code		4-Step Order Code	
		Group	Flux (lm) @ 85 °C	Flux (lm) @ 25 °C*	Chromaticity Region		Chromaticity Region	
EasyWhite	3000K	Q4	2260	2549	30H	CXA2530-0000-000N0UQ430H	30F	CXA2530-0000-000N0UQ430F
		R2	2420	2729		CXA2530-0000-000N0UR230H		CXA2530-0000-000N0UR230F
		R4	2600	2932		CXA2530-0000-000N0UR430H		CXA2530-0000-000N0UR430F
	2700K	Q2	2100	2368	27H	CXA2530-0000-000N0UQ227H	27F	CXA2530-0000-000N0UQ227F
		Q4	2260	2549		CXA2530-0000-000N0UQ427H		CXA2530-0000-000N0UQ427F

Color	CCT Range	Base Order Codes Min. Luminous Flux @ 800 mA			Chromaticity Regions	Order Code
		Group	Flux (lm) @ 85 °C	Flux (lm) @ 25 °C*		
ANSI White	3000K	Q4	2260	2549	7A0, 7B0, 7C0, 7D0	CXA2530-0000-000N0UQ40E7
		R2	2420	2729		CXA2530-0000-000N0UR20E7
		R4	2600	2932		CXA2530-0000-000N0UR40E7
	2700K	Q2	2100	2368	8A0, 8B0, 8C0, 8D0	CXA2530-0000-000N0UQ20E8
		Q4	2260	2549		CXA2530-0000-000N0UQ40E8

**Notes:**

- Cree maintains a tolerance of  $\pm 7\%$  on flux and power measurements,  $\pm 0.005$  on chromaticity (CCx, CCy) measurements and a tolerance of  $\pm 2$  on CRI measurements.
- Minimum CRI for high CRI color temperatures 0E8, 27F, 27H, 0E7, 30F, 30H is 90.
- \* Flux values @ 25 °C are calculated and for reference only.

**FLUX CHARACTERISTICS, STANDARD ORDER CODES AND BINS, 80 CRI ( $I_F = 800 \text{ mA}$ ,  $T_j = 85 \text{ }^\circ\text{C}$ )**

The following tables provide order codes for XLamp CXA2530 80 CRI minimum LEDs. For a complete description of the order code nomenclature, please reference Bin and Order Code Formats (page 13).

Color	CCT Range	Base Order Codes Min. Luminous Flux @ 800 mA			2-Step Order Code		4-Step Order Code	
		Group	Flux (lm) @ 85 °C	Flux (lm) @ 25 °C*	Chromaticity Region		Chromaticity Region	
EasyWhite	5000K	S4	2990	3372	50H	CXA2530-0000-000N0HS450H	50F	CXA2530-0000-000N0HS450F
		T2	3200	3609		CXA2530-0000-000N0HT250H		CXA2530-0000-000N0HT250F
		T4	3440	3879		CXA2530-0000-000N0HT450H		CXA2530-0000-000N0HT450F
	4000K	S4	2990	3372	40H	CXA2530-0000-000N0HS440H	40F	CXA2530-0000-000N0HS440F
		T2	3200	3609		CXA2530-0000-000N0HT240H		CXA2530-0000-000N0HT240F

Color	CCT Range	Base Order Codes Min Luminous Flux @ 800 mA			Chromaticity Regions	Order Code
		Group	Flux (lm) @ 85 °C	Flux (lm) @ 25 °C*		
ANSI White	5000K	S4	2990	3372	3A0, 3B0, 3C0, 3D0	CXA2530-0000-000N0HS40E3
		T2	3200	3609		CXA2530-0000-000N0HT20E3
		T4	3440	3879		CXA2530-0000-000N0HT40E3
	4000K	S4	2990	3372	5A0, 5B0, 5C0, 5D0	CXA2530-0000-000N0HS40E5
		T2	3200	3609		CXA2530-0000-000N0HT20E5

**Notes:**

- Cree maintains a tolerance of  $\pm 7\%$  on flux and power measurements,  $\pm 0.005$  on chromaticity (CCx, CCy) measurements and a tolerance of  $\pm 2$  on CRI measurements.
- Minimum CRI for high CRI color temperatures 0E5, 40F, 40H, 0E3, 50F, 50H is 80.
- \* Flux values @ 25 °C are calculated and for reference only.

**RELATIVE SPECTRAL POWER DISTRIBUTION ( $I_F = 800 \text{ mA}$ ,  $T_J = 85 \text{ }^\circ\text{C}$ )**

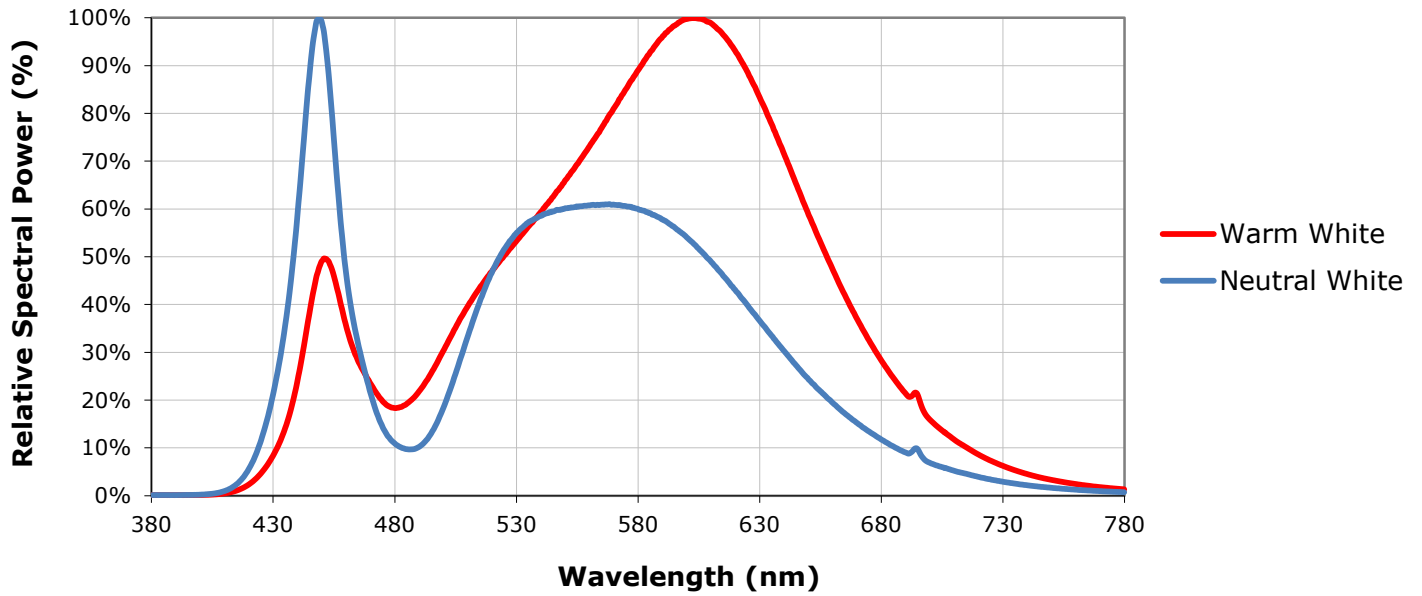

**RELATIVE LUMINOUS FLUX VS. JUNCTION TEMPERATURE ( $I_F = 800 \text{ mA}$ )**

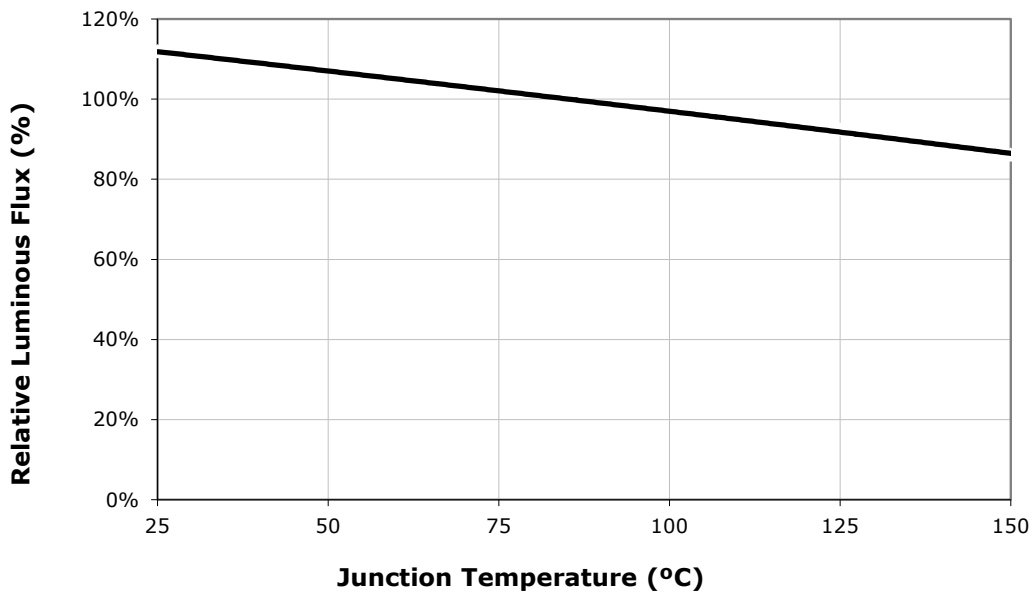

**ELECTRICAL CHARACTERISTICS ( $T_j = 85\text{ }^\circ\text{C}$ )**

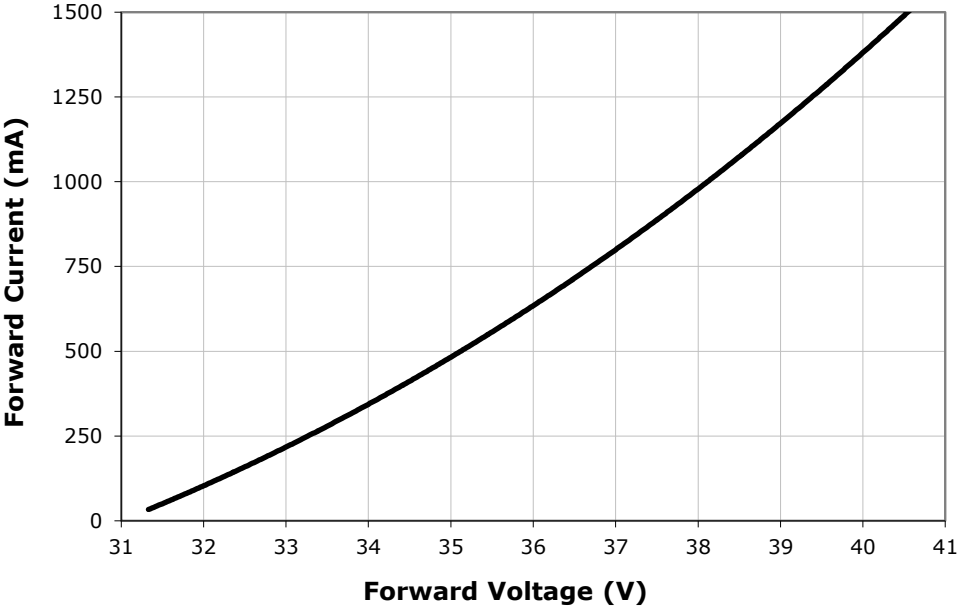

**RELATIVE LUMINOUS FLUX VS. CURRENT ( $T_j = 85\text{ }^\circ\text{C}$ )**

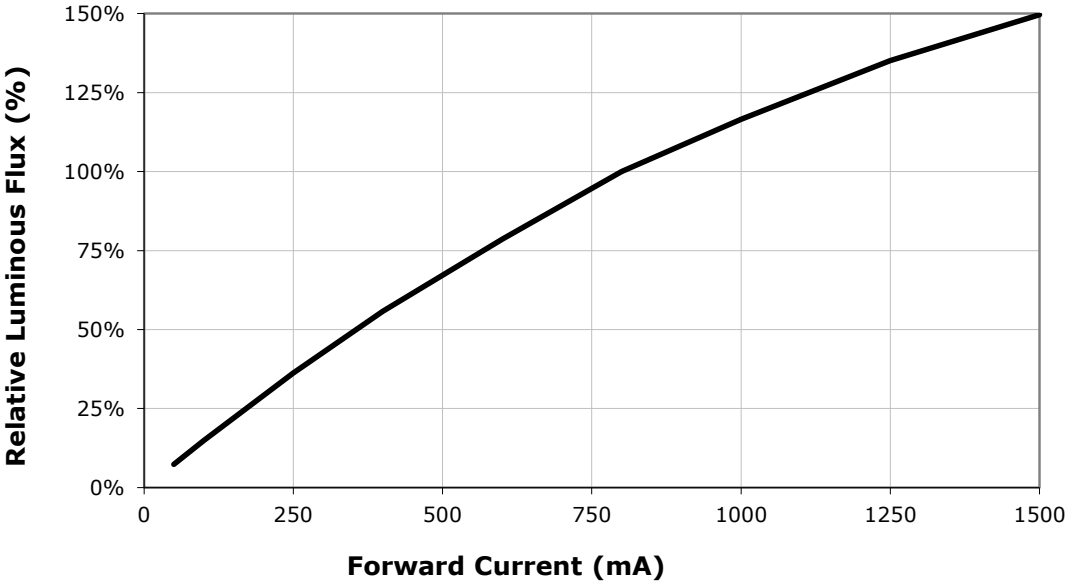

**RELATIVE CHROMATICITY VS. CURRENT AND TEMPERATURE (3000K, 80 CRI)**

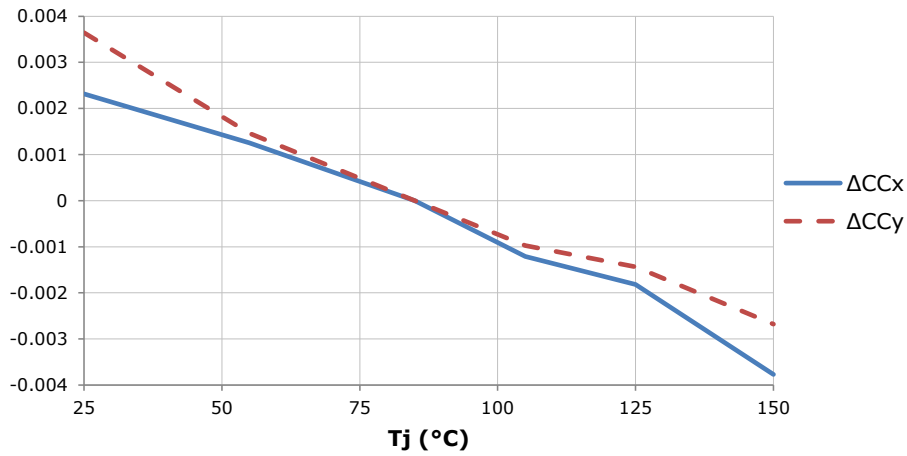
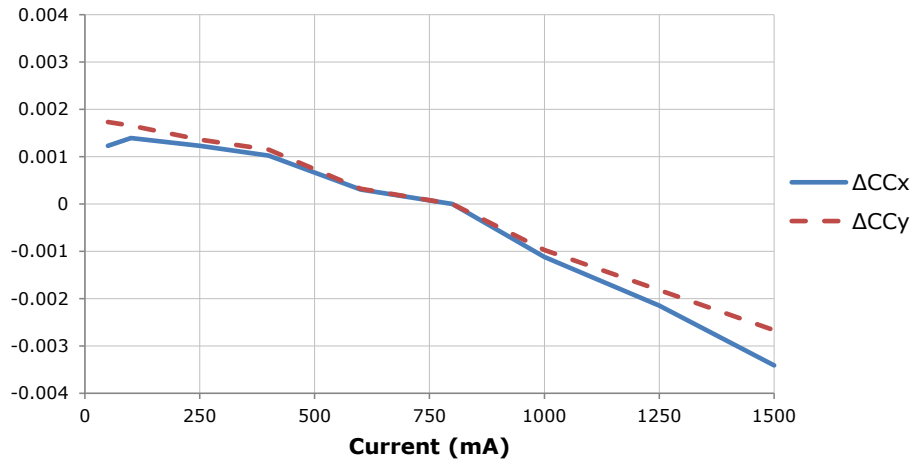



**TYPICAL SPATIAL DISTRIBUTION**

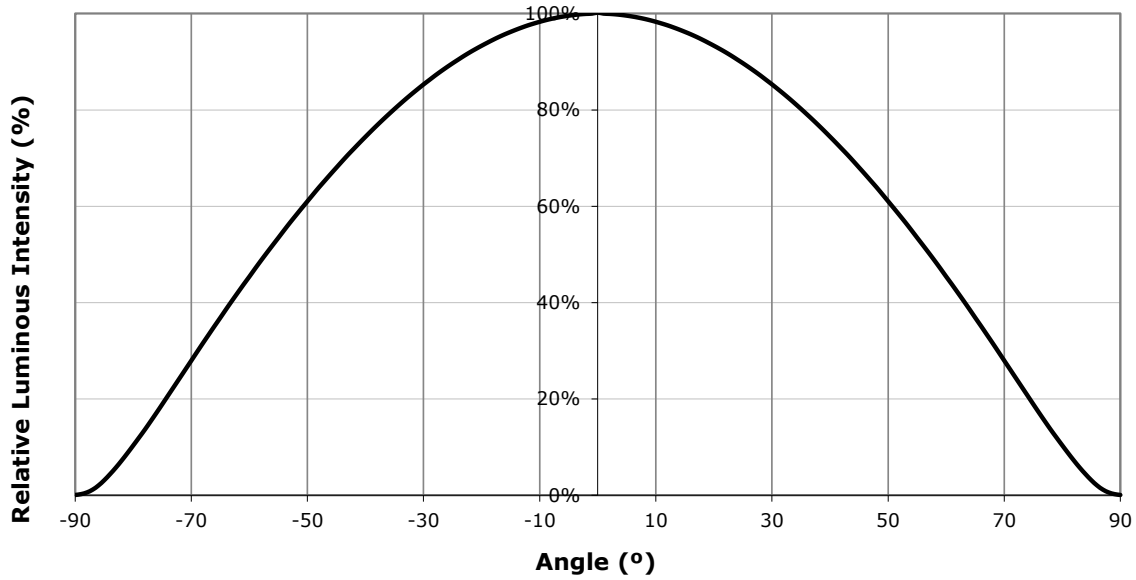

**PERFORMANCE GROUPS - BRIGHTNESS ( $I_f = 800 \text{ mA}$ ,  $T_j = 85 \text{ °C}$ )**

XLamp CXA2530 LEDs are tested for luminous flux and placed into one of the following bins.

Group Code	Min. Luminous Flux @ 800 mA	Max. Luminous Flux @ 800 mA
Q2	2100	2260
Q4	2260	2420
R2	2420	2600
R4	2600	2780
S2	2780	2990
S4	2990	3200
T2	3200	3440
T4	3440	3680
U2	3680	3955

**PERFORMANCE GROUPS - CHROMATICITY (T<sub>j</sub> = 85 °C)**

XLamp CXA2530 LEDs are tested for chromaticity and placed into one of the regions defined by the following bounding coordinates.

EasyWhite Color Temperatures – 4-Step			
Code	CCT	x	y
50F	5000K	0.3407	0.3459
		0.3415	0.3586
		0.3499	0.3654
		0.3484	0.3521
40F	4000K	0.3744	0.3685
		0.3782	0.3837
		0.3912	0.3917
		0.3863	0.3758
35F	3500K	0.3981	0.3800
		0.4040	0.3966
		0.4186	0.4037
		0.4116	0.3865
30F	3000K	0.4242	0.3919
		0.4322	0.4096
		0.4449	0.4141
		0.4359	0.3960
27F	2700K	0.4475	0.3994
		0.4573	0.4178
		0.4695	0.4207
		0.4589	0.4021

EasyWhite Color Temperatures – 2-Step			
Code	CCT	x	y
50H	5000K	0.3429	0.3507
		0.3434	0.3571
		0.3475	0.3604
		0.3469	0.3539
40H	4000K	0.3784	0.3741
		0.3804	0.3818
		0.3867	0.3857
		0.3844	0.3778
35H	3500K	0.4030	0.3857
		0.4061	0.3941
		0.4132	0.3976
		0.4099	0.3890
30H	3000K	0.4291	0.3973
		0.4333	0.4062
		0.4395	0.4084
		0.4351	0.3994
27H	2700K	0.4528	0.4046
		0.4578	0.4138
		0.4638	0.4152
		0.4586	0.4060

ANSI White Bins				
Code	CCT	Bin Code	x	y
0E3	5000K	3A0	.3371	.3490
			.3451	.3554
			.3440	.3427
			.3366	.3369
		3B0	.3376	.3616
			.3463	.3687
			.3451	.3554
			.3371	.3490
		3C0	.3463	.3687
			.3551	.3760
			.3533	.3620
			.3451	.3554
		3D0	.3451	.3554
			.3533	.3620
			.3515	.3487
			.3440	.3427

ANSI White Bins				
Code	CCT	Bin Code	x	y
0E5	4000K	5A0	.3670	.3578
			.3702	.3722
			.3825	.3798
			.3783	.3646
		5B0	.3702	.3722
			.3736	.3874
			.3869	.3958
			.3825	.3798
		5C0	.3825	.3798
			.3869	.3958
			.4006	.4044
			.3950	.3875
		5D0	.3783	.3646
			.3825	.3798
			.3950	.3875
			.3898	.3716

ANSI White Bins				
Code	CCT	Bin Code	x	y
0E6	3500K	6A0	.3889	.3690
			.3941	.3848
			.4080	.3916
			.4017	.3751
		6B0	.3941	.3848
			.3996	.4015
			.4146	.4089
			.4080	.3916
		6C0	.4080	.3916
			.4146	.4089
			.4299	.4165
			.4221	.3984
		6D0	.4017	.3751
			.4080	.3916
			.4221	.3984
			.4147	.3814

ANSI White Bins				
Code	CCT	Bin Code	x	y
0E7	3000K	7A0	.4147	.3814
			.4221	.3984
			.4342	.4028
			.4259	.3853
		7B0	.4221	.3984
			.4299	.4165
			.4430	.4212
			.4342	.4028
		7C0	.4342	.4028
			.4430	.4212
			.4562	.4260
			.4465	.4071
		7D0	.4259	.3853
			.4342	.4028
			.4465	.4071
			.4373	.3893

  

ANSI White Bins				
Code	CCT	Bin Code	x	y
0E8	2700K	8A0	.4373	.3893
			.4465	.4071
			.4582	.4099
			.4483	.3919
		8B0	.4465	.4071
			.4562	.4260
			.4687	.4289
			.4582	.4099
		8C0	.4582	.4099
			.4687	.4289
			.4813	.4319
			.4700	.4126
		8D0	.4483	.3919
			.4582	.4099
			.4700	.4126
			.4593	.3944

**CREE EASYWHITE BINS PLOTTED ON THE 1931 CIE COLOR SPACE ( $T_j = 85^\circ\text{C}$ )**

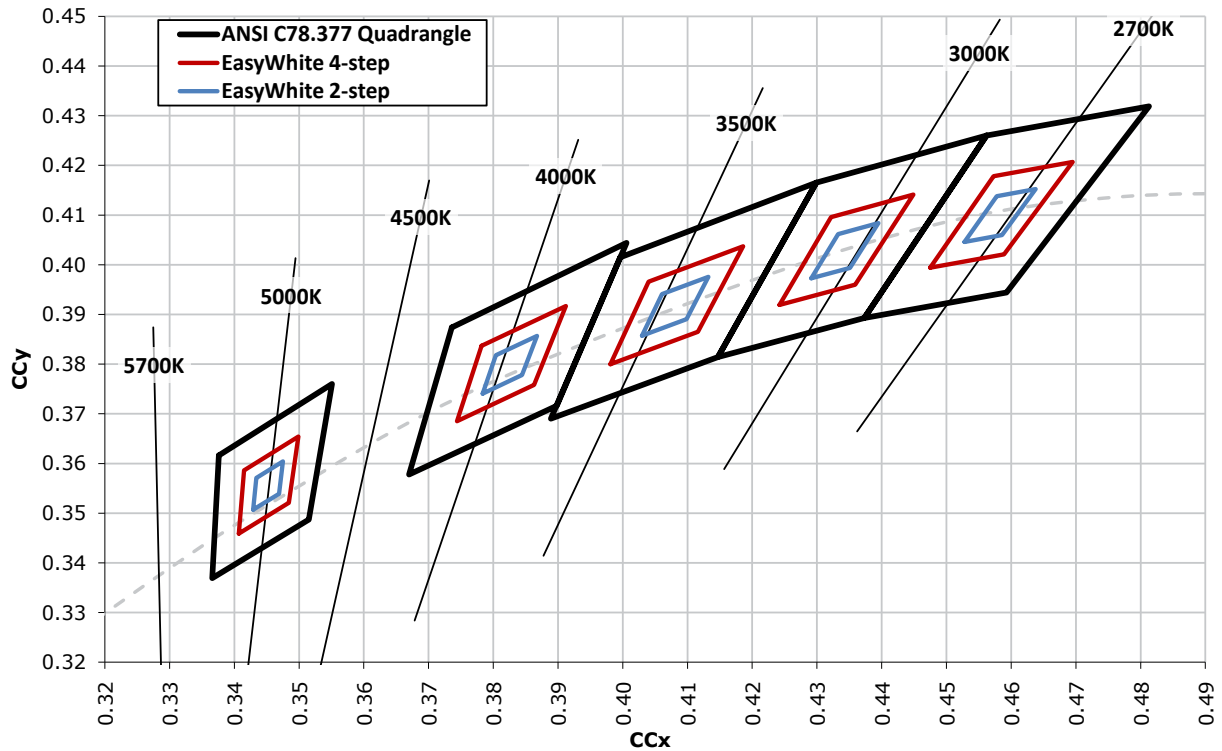

**CREE ANSI WHITE BINS PLOTTED ON THE 1931 CIE COLOR SPACE ( $T_j = 85^\circ\text{C}$ )**

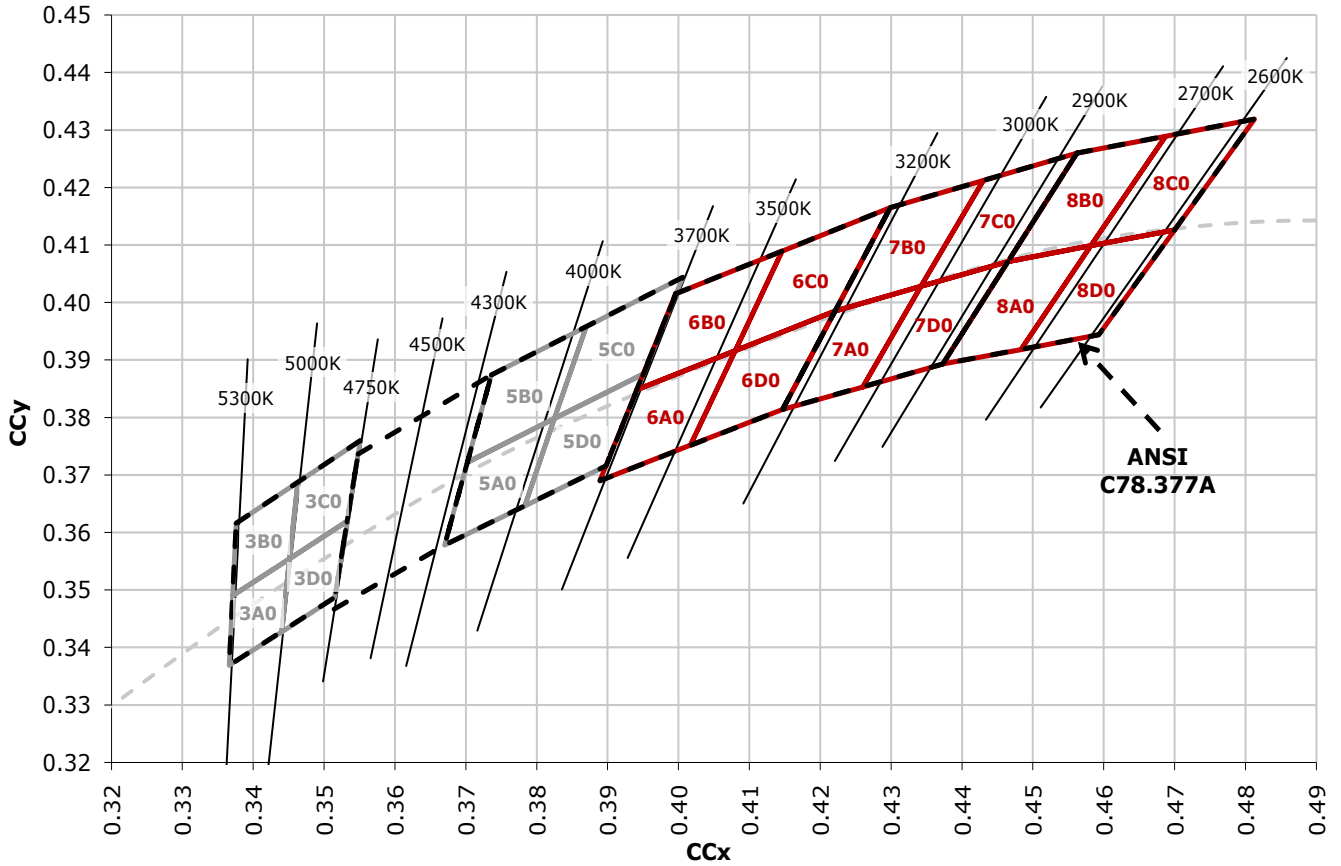

### BIN AND ORDER CODE FORMATS

Bin codes and order codes are configured as follows:

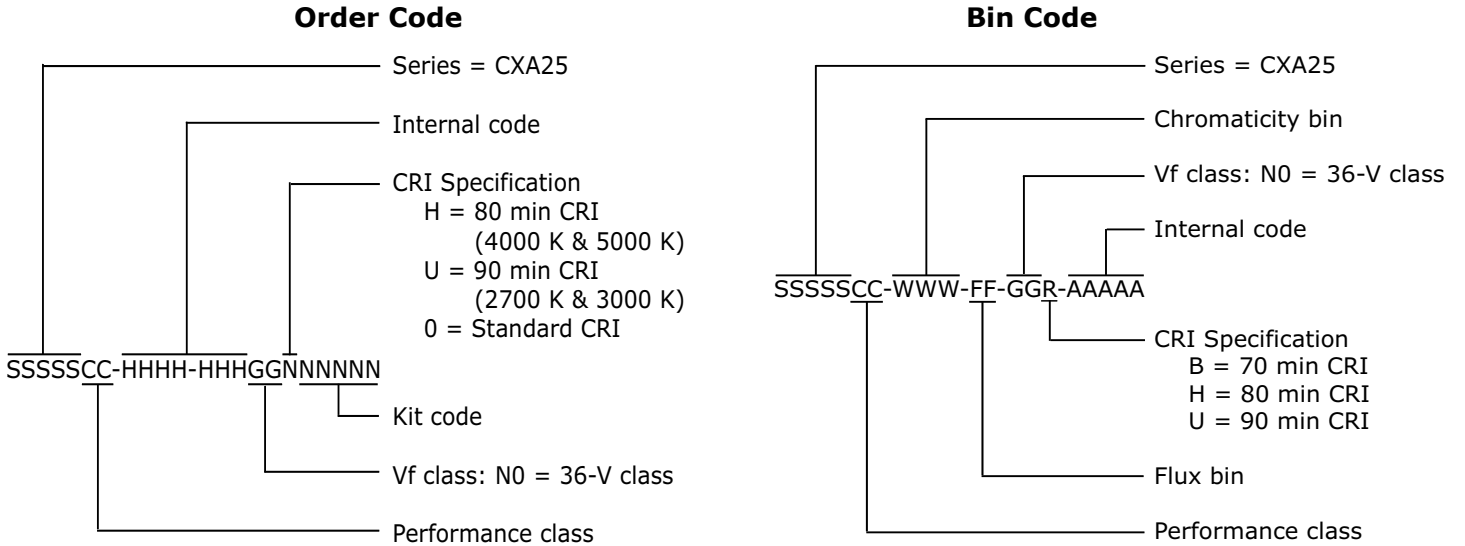

### MECHANICAL DIMENSIONS

Dimensions are in mm.

Tolerances unless otherwise

specified:

.x ± .10

.xx ± .03

.xxx ± .010

x° ± 1° x ± .10

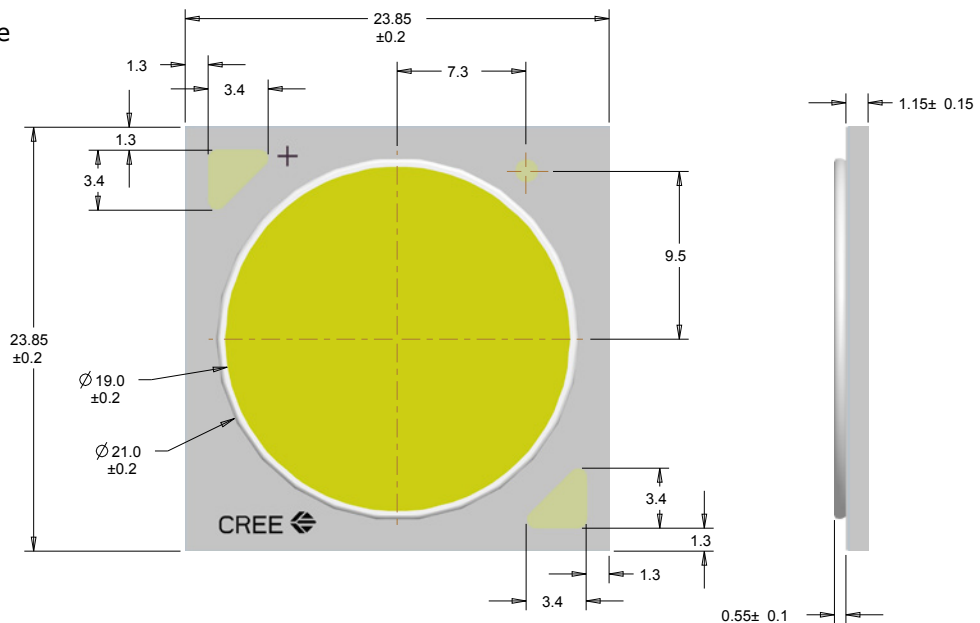

## NOTES

---

### **Lumen Maintenance Projections**

Cree now uses standardized IES LM-80-08 and TM-21-11 methods for collecting long-term data and extrapolating LED lumen maintenance. For information on the specific LM-80 data sets available for this LED, refer to the public LM-80 results document at [www.cree.com/xlamp\\_app\\_notes/LM80\\_results](http://www.cree.com/xlamp_app_notes/LM80_results).

Please read the XLamp Long-Term Lumen Maintenance application note at [www.cree.com/xlamp\\_app\\_notes/lumen\\_maintenance](http://www.cree.com/xlamp_app_notes/lumen_maintenance) for more details on Cree's lumen maintenance testing and forecasting. Please read the XLamp Thermal Management application note at [www.cree.com/xlamp\\_app\\_notes/thermal\\_management](http://www.cree.com/xlamp_app_notes/thermal_management) for details on how thermal design, ambient temperature, and drive current affect the LED junction temperature.

### **UL Recognized Component**

Level 4 enclosure consideration. The LED package or a portion thereof has been investigated as a fire and electrical enclosure per ANSI/UL 8750.

### **Vision Advisory Claim**

Users should be cautioned not to stare at the light of this LED product. The bright light can damage the eye.

**PACKAGING**

Cree CXA2530 LEDs are packaged in tubes of 20, which are then combined in boxes of 5 tubes, or 100 LEDs. Boxes of 100 LEDs are of the same performance bin.

Dimensions are in mm.  
 Tolerances unless otherwise specified:  
 .x ± .10  
 .xx ± .03  
 .xxx ± .010  
 x° ± 1°

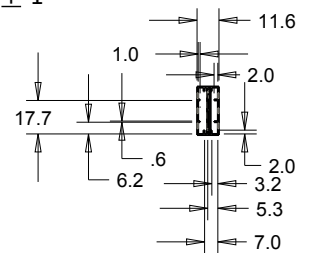
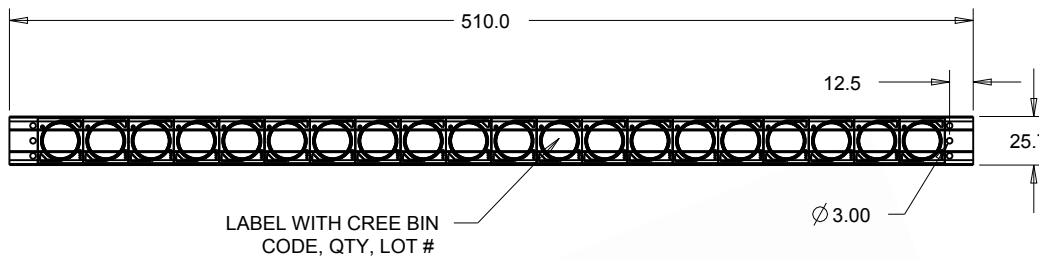

PATENT LABEL IS LOCATED ON UNDERSIDE OF COVER

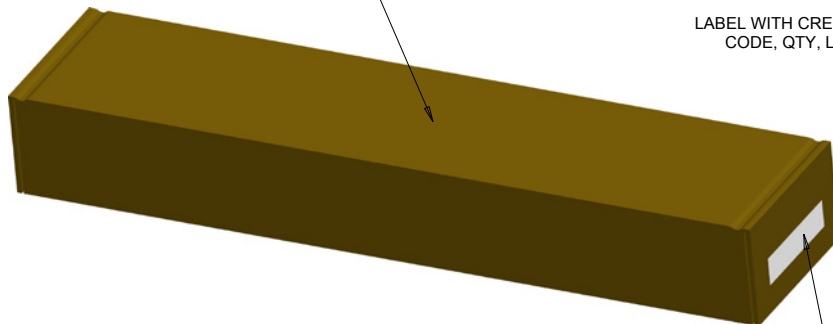

LABEL WITH CREE BIN CODE, QTY, LOT #

LABEL WITH CREE BIN CODE, QTY, LOT #



Компания «ЭлектроПласт» предлагает заключение долгосрочных отношений при поставках импортных электронных компонентов на взаимовыгодных условиях!

Наши преимущества:

- Оперативные поставки широкого спектра электронных компонентов отечественного и импортного производства напрямую от производителей и с крупнейших мировых складов;
- Поставка более 17-ти миллионов наименований электронных компонентов;
- Поставка сложных, дефицитных, либо снятых с производства позиций;
- Оперативные сроки поставки под заказ (от 5 рабочих дней);
- Экспресс доставка в любую точку России;
- Техническая поддержка проекта, помощь в подборе аналогов, поставка прототипов;
- Система менеджмента качества сертифицирована по Международному стандарту ISO 9001;
- Лицензия ФСБ на осуществление работ с использованием сведений, составляющих государственную тайну;
- Поставка специализированных компонентов (Xilinx, Altera, Analog Devices, Intersil, Interpoint, Microsemi, Aeroflex, Peregrine, Syfer, Eurofarad, Texas Instrument, Miteq, Cobham, E2V, MA-COM, Hittite, Mini-Circuits, General Dynamics и др.);

Помимо этого, одним из направлений компании «ЭлектроПласт» является направление «Источники питания». Мы предлагаем Вам помощь Конструкторского отдела:

- Подбор оптимального решения, техническое обоснование при выборе компонента;
- Подбор аналогов;
- Консультации по применению компонента;
- Поставка образцов и прототипов;
- Техническая поддержка проекта;
- Защита от снятия компонента с производства.



#### Как с нами связаться

**Телефон:** 8 (812) 309 58 32 (многоканальный)

**Факс:** 8 (812) 320-02-42

**Электронная почта:** [org@eplast1.ru](mailto:org@eplast1.ru)

**Адрес:** 198099, г. Санкт-Петербург, ул. Калинина, дом 2, корпус 4, литера А.