

## N-channel 600 V, 0.135 $\Omega$ typ., 20 A MDmesh™ II Power MOSFET in a TO-220FP package

Datasheet - production data

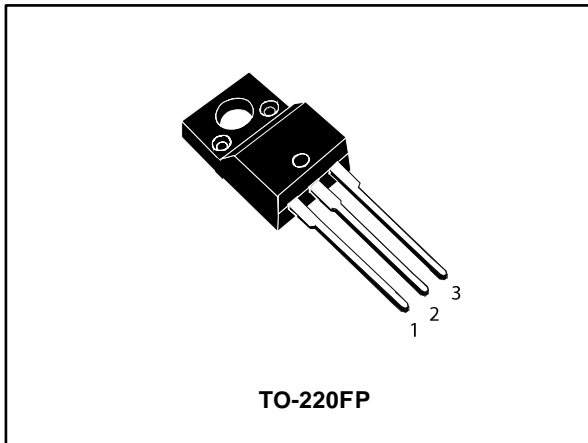
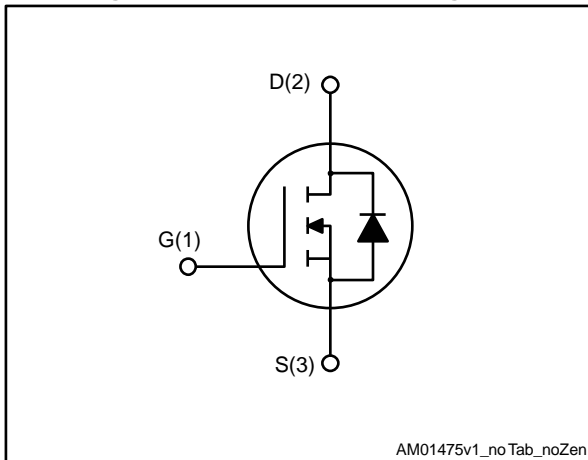

Figure 1: Internal schematic diagram



### Features

| Order code | V <sub>DS</sub> | R <sub>DS(on)</sub> max | I <sub>D</sub> |
|------------|-----------------|-------------------------|----------------|
| STF26NM60N | 600 V           | 0.165 $\Omega$          | 20 A           |

- 100% avalanche tested
- Low input capacitance and gate charge
- Low gate input resistance

### Applications

- Switching applications

### Description

This device is an N-channel Power MOSFET developed using the second generation of MDmesh™ technology. This revolutionary Power MOSFET associates a vertical structure to the company's strip layout to yield one of the world's lowest on-resistance and gate charge. It is therefore suitable for the most demanding high efficiency converters.

Table 1: Device summary

| Order code | Marking | Package  | Packaging |
|------------|---------|----------|-----------|
| STF26NM60N | 26NM60N | TO-220FP | Tube      |

## Contents

|          |  |           |
|----------|--|-----------|
| <b>1</b> | <b>Electrical ratings .....</b>              | <b>3</b>  |
| <b>2</b> | <b>Electrical characteristics .....</b>      | <b>4</b>  |
|          | 2.1 Electrical characteristics (curves)..... | 6         |
| <b>3</b> | <b>Test circuits .....</b>                   | <b>8</b>  |
| <b>4</b> | <b>Package information .....</b>             | <b>9</b>  |
|          | 4.1 TO-220FP package information .....       | 10        |
| <b>5</b> | <b>Revision history .....</b>                | <b>12</b> |

# 1 Electrical ratings

**Table 2: Absolute maximum ratings**

| Symbol            | Parameter  | Value      | Unit             |
|-------------------|--|------------|------------------|
| $V_{DS}$          | Drain-source voltage   | 600        | V                |
| $V_{GS}$          | Gate-source voltage  | $\pm 30$   | V                |
| $I_D^{(1)}$       | Drain current (continuous) at $T_C = 25\text{ }^\circ\text{C}$   | 20         | A                |
| $I_D^{(1)}$       | Drain current (continuous) at $T_C = 100\text{ }^\circ\text{C}$  | 12.6       | A                |
| $I_{DM}^{(1)(2)}$ | Drain current (pulsed)   | 80         | A                |
| $P_{TOT}$         | Total dissipation at $T_C = 25\text{ }^\circ\text{C}$  | 35         | W                |
| $dv/dt^{(3)}$     | Peak diode recovery voltage slope  | 15         | V/ns             |
| $V_{ISO}$         | Insulation withstand voltage (RMS) from all three leads to external heat sink<br>( $t = 1\text{ s}$ ; $T_C = 25\text{ }^\circ\text{C}$ ) | 2500       | V                |
| $T_{stg}$         | Storage temperature range  | -55 to 150 | $^\circ\text{C}$ |
| $T_j$             | Operating junction temperature range   |            |                  |

**Notes:**

<sup>(1)</sup>Limited by package.

<sup>(2)</sup>Pulse width limited by safe operating area.

<sup>(3)</sup> $I_{SD} \leq 20\text{ A}$ ,  $di/dt \leq 400\text{ A}/\mu\text{s}$ ,  $V_{DS(\text{peak})} \leq V_{(BR)DSS}$ ,  $V_{DD} \leq 80\% V_{(BR)DSS}$

**Table 3: Thermal data**

| Symbol                | Parameter                           | Value | Unit                      |
|-----------------------|-------------------------------------|-------|---------------------------|
| $R_{thj\text{-case}}$ | Thermal resistance junction-case    | 3.6   | $^\circ\text{C}/\text{W}$ |
| $R_{thj\text{-amb}}$  | Thermal resistance junction-ambient | 62.5  | $^\circ\text{C}/\text{W}$ |

**Table 4: Avalanche characteristics**

| Symbol   | Parameter   | Value | Unit |
|----------|---|-------|------|
| $I_{AS}$ | Single pulse avalanche current (pulse width limited by $T_{j\text{max}}$ )  | 6     | A    |
| $E_{AS}$ | Single pulse avalanche energy<br>(starting $T_J=25\text{ }^\circ\text{C}$ , $I_D=I_{AR}$ , $V_{DD}=50\text{ V}$ ) | 610   | mJ   |

## 2 Electrical characteristics

( $T_{CASE} = 25\text{ °C}$  unless otherwise specified)

**Table 5: On/off states**

| Symbol        | Parameter                         | Test conditions   | Min. | Typ.  | Max.      | Unit          |
|---------------|-----------------------------------|---|------|-------|-----------|---------------|
| $V_{(BR)DSS}$ | Drain-source breakdown voltage    | $I_D = 1\text{ mA}$ , $V_{GS} = 0\text{ V}$   | 600  |       |           | V             |
| $I_{DSS}$     | Zero gate voltage drain current   | $V_{GS} = 0\text{ V}$ , $V_{DS} = 600\text{ V}$   |      |       | 1         | $\mu\text{A}$ |
|               |                                   | $V_{GS} = 0\text{ V}$ , $V_{DS} = 600\text{ V}$ ,<br>$T_C = 125\text{ °C}$ <sup>(1)</sup> |      |       | 100       |               |
| $I_{GSS}$     | Gate-body leakage current         | $V_{DS} = 0\text{ V}$ , $V_{GS} = \pm 25\text{ V}$  |      |       | $\pm 0.1$ | $\mu\text{A}$ |
| $V_{GS(th)}$  | Gate threshold voltage            | $V_{DS} = V_{GS}$ , $I_D = 250\text{ }\mu\text{A}$  | 2    | 3     | 4         | V             |
| $R_{DS(on)}$  | Static drain-source on-resistance | $V_{GS} = 10\text{ V}$ , $I_D = 10\text{ A}$  |      | 0.135 | 0.165     | $\Omega$      |

**Notes:**

<sup>(1)</sup>Defined by design, not subject to production test.

**Table 6: Dynamic**

| Symbol                     | Parameter                     | Test conditions  | Min. | Typ. | Max. | Unit     |
|----------------------------|-------------------------------|--|------|------|------|----------|
| $C_{iss}$                  | Input capacitance             | $V_{DS} = 50\text{ V}$ , $f = 1\text{ MHz}$ ,<br>$V_{GS} = 0\text{ V}$   | -    | 1800 | -    | pF       |
| $C_{oss}$                  | Output capacitance            |  | -    | 115  | -    | pF       |
| $C_{riss}$                 | Reverse transfer capacitance  |  | -    | 6    | -    | pF       |
| $C_{oss\text{ eq.}}^{(1)}$ | Equivalent output capacitance | $V_{GS} = 0\text{ V}$ , $V_{DS} = 0\text{ to }480\text{ V}$  | -    | 310  | -    | pF       |
| $Q_g$                      | Total gate charge             | $V_{DD} = 480\text{ V}$ , $I_D = 20\text{ A}$ ,<br>$V_{GS} = 10\text{ V}$<br>(see <a href="#">Figure 14: "Test circuit for gate charge behavior"</a> ) | -    | 60   | -    | nC       |
| $Q_{gs}$                   | Gate-source charge            |  | -    | 8.5  | -    | nC       |
| $Q_{gd}$                   | Gate-drain charge             |  | -    | 30   | -    | nC       |
| $R_G$                      | Gate input resistance         | $f = 1\text{ MHz}$ , $I_D = 0\text{ A}$  | -    | 2.8  | -    | $\Omega$ |

**Notes:**

<sup>(1)</sup> $C_{oss\text{ eq.}}$  is defined as a constant equivalent capacitance giving the same charging time as  $C_{oss}$  when  $V_{DS}$  increases from 0 to 80%  $V_{DS}$

**Table 7: Switching times**

| Symbol       | Parameter           | Test conditions  | Min. | Typ. | Max. | Unit |
|--------------|---------------------|--|------|------|------|------|
| $t_{d(on)}$  | Turn-on delay time  | $V_{DD} = 300\text{ V}$ , $I_D = 10\text{ A}$ ,<br>$R_G = 4.7\text{ }\Omega$ , $V_{GS} = 10\text{ V}$<br>(see <a href="#">Figure 13: "Test circuit for resistive load switching times"</a><br>and <a href="#">Figure 18: "Switching time waveform"</a> ) | -    | 13   | -    | ns   |
| $t_r$        | Rise time           |  | -    | 25   | -    | ns   |
| $t_{d(off)}$ | Turn-off delay time |  | -    | 85   | -    | ns   |
| $t_f$        | Fall time           |  | -    | 50   | -    | ns   |

Table 8: Source-drain diode

| Symbol          | Parameter                     | Test conditions  | Min. | Typ. | Max. | Unit          |
|-----------------|-------------------------------|--|------|------|------|---------------|
| $I_{SD}^{(1)}$  | Source-drain current          |  | -    |      | 20   | A             |
| $I_{SDM}^{(2)}$ | Source-drain current (pulsed) |  | -    |      | 80   | A             |
| $V_{SD}^{(3)}$  | Forward on voltage            | $I_{SD} = 20\text{ A}$ , $V_{GS} = 0\text{ V}$   | -    |      | 1.5  | V             |
| $t_{rr}$        | Reverse recovery time         | $I_{SD} = 20\text{ A}$ , $di/dt = 100\text{ A}/\mu\text{s}$<br>$V_{DD} = 60\text{ V}$<br>(see <a href="#">Figure 15: "Test circuit for inductive load switching and diode recovery times"</a> )                                  | -    | 370  |      | ns            |
| $Q_{rr}$        | Reverse recovery charge       |  | -    | 5.8  |      | $\mu\text{C}$ |
| $I_{RRM}$       | Reverse recovery current      |  | -    | 31.6 |      | A             |
| $t_{rr}$        | Reverse recovery time         | $I_{SD} = 20\text{ A}$ , $di/dt = 100\text{ A}/\mu\text{s}$<br>$V_{DD} = 60\text{ V}$ , $T_j = 150\text{ }^\circ\text{C}$ (see <a href="#">Figure 15: "Test circuit for inductive load switching and diode recovery times"</a> ) | -    | 450  |      | ns            |
| $Q_{rr}$        | Reverse recovery charge       |  | -    | 7.5  |      | $\mu\text{C}$ |
| $I_{RRM}$       | Reverse recovery current      |  | -    | 32.5 |      | A             |

**Notes:**

(1) Pulse width limited by package.

(2) Pulse width limited by safe operating area.

(3) Pulsed: pulse duration = 300  $\mu\text{s}$ , duty cycle 1.5%

## 2.1 Electrical characteristics (curves)

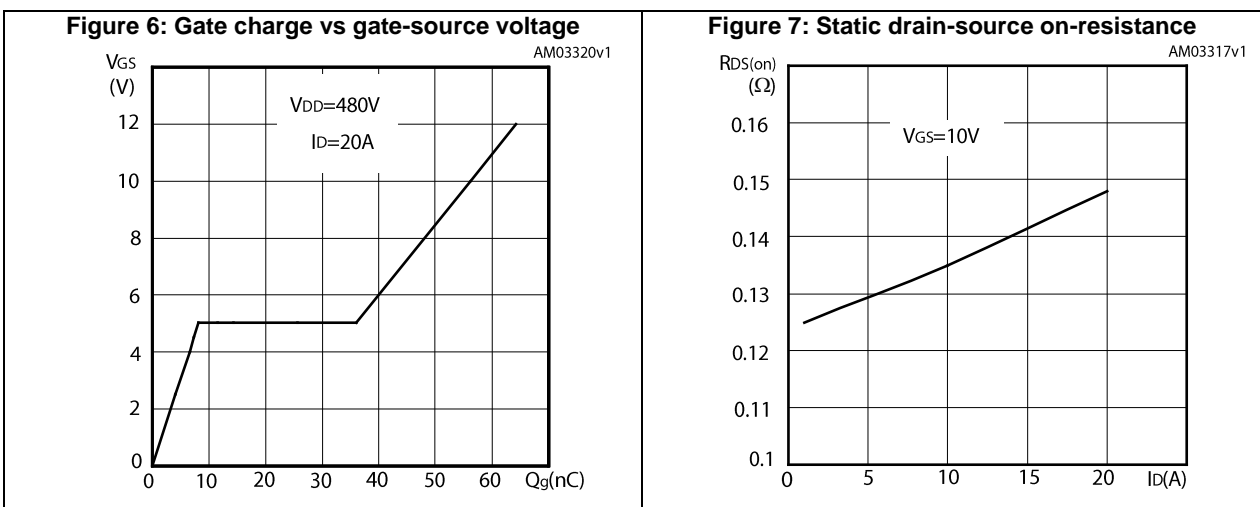
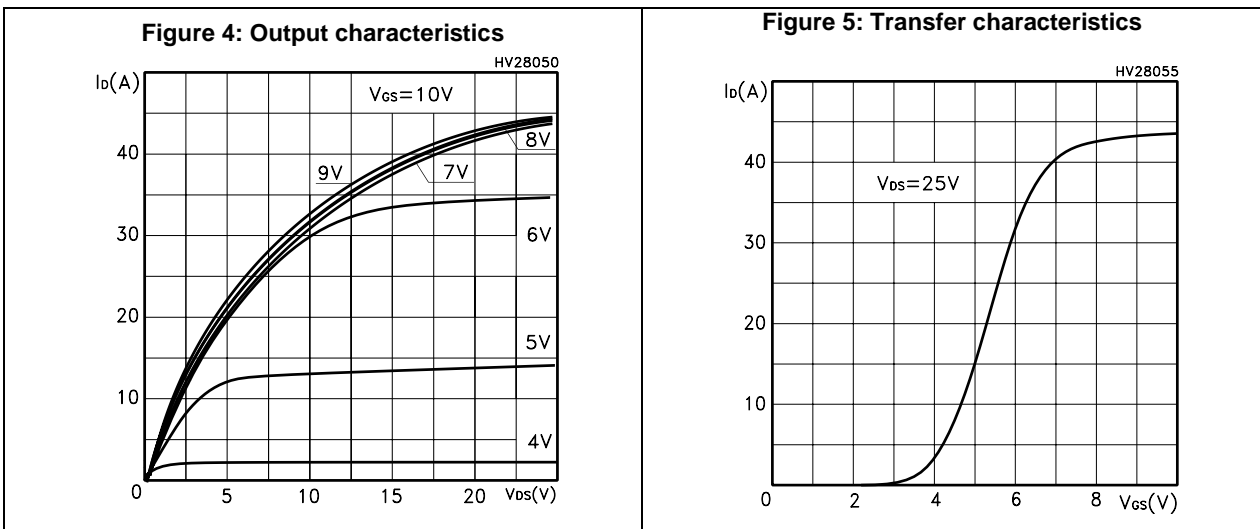
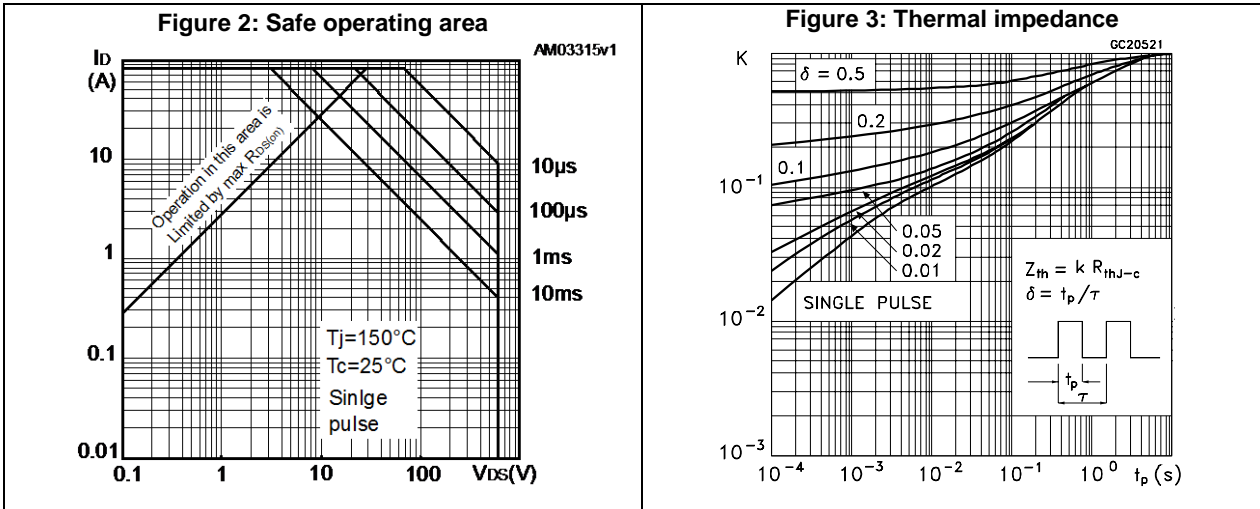

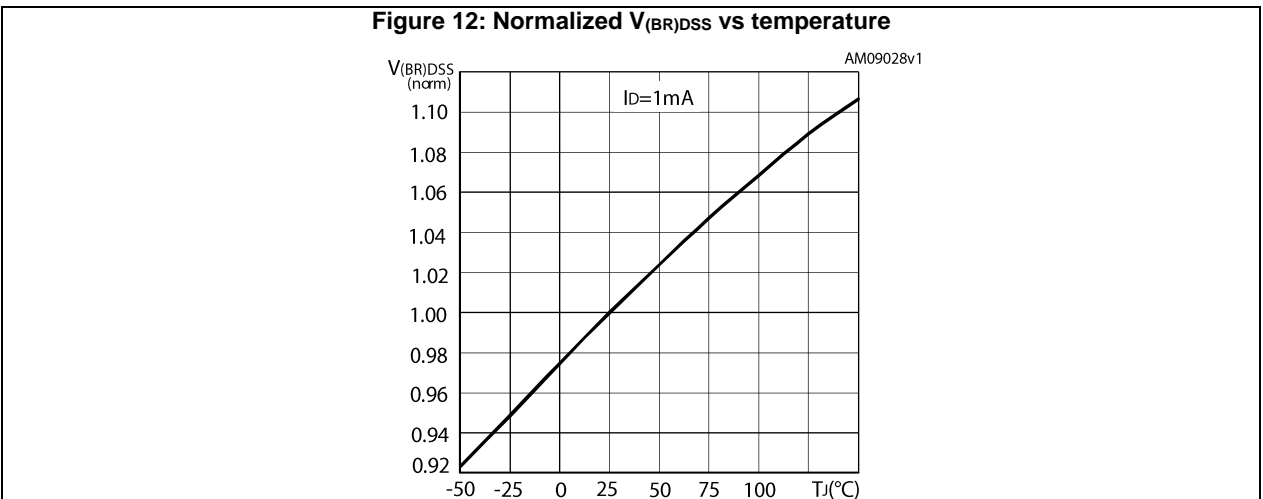
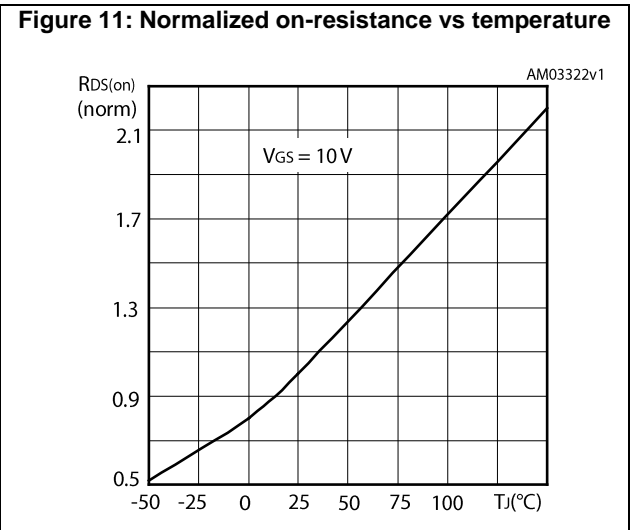
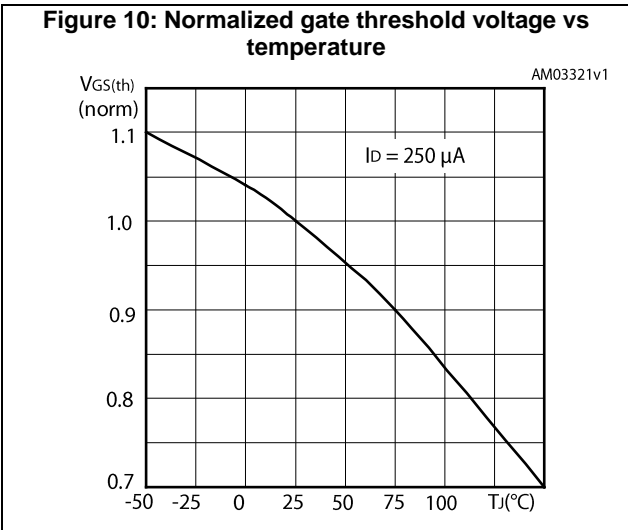
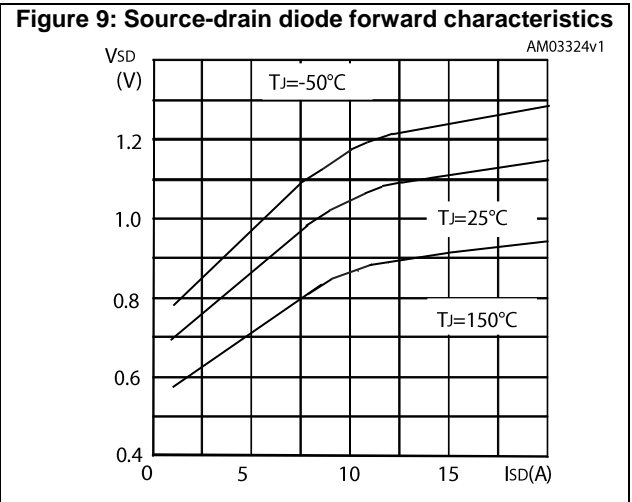
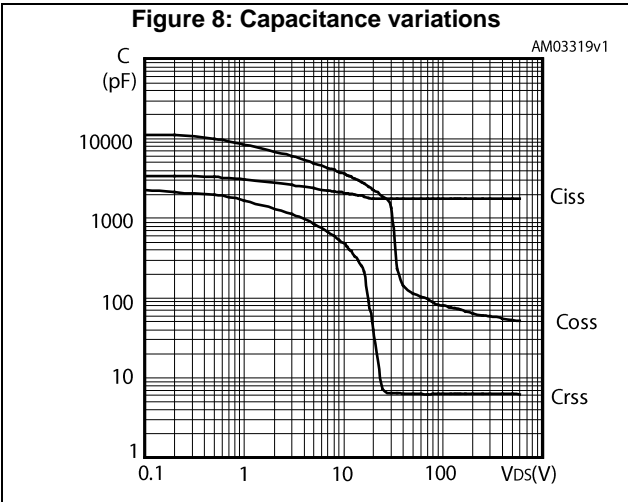

### 3 Test circuits

**Figure 13: Test circuit for resistive load switching times**



AM01468v1

**Figure 14: Test circuit for gate charge behavior**



AM01469v1

**Figure 15: Test circuit for inductive load switching and diode recovery times**



AM01470v1

**Figure 16: Unclamped inductive load test circuit**

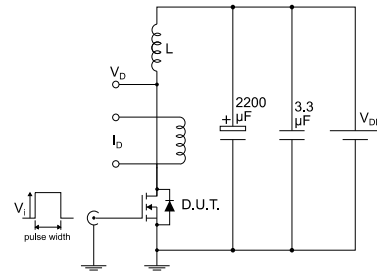

AM01471v1

**Figure 17: Unclamped inductive waveform**

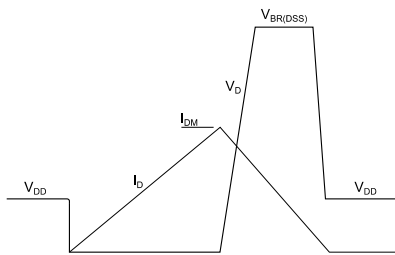

AM01472v1

**Figure 18: Switching time waveform**

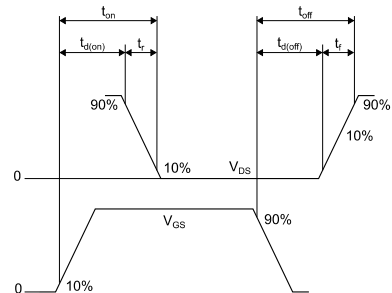

AM01473v1



## 4 Package information

In order to meet environmental requirements, ST offers these devices in different grades of ECOPACK® packages, depending on their level of environmental compliance. ECOPACK® specifications, grade definitions and product status are available at: [www.st.com](http://www.st.com). ECOPACK® is an ST trademark.

### 4.1 TO-220FP package information

Figure 19: TO-220FP package outline

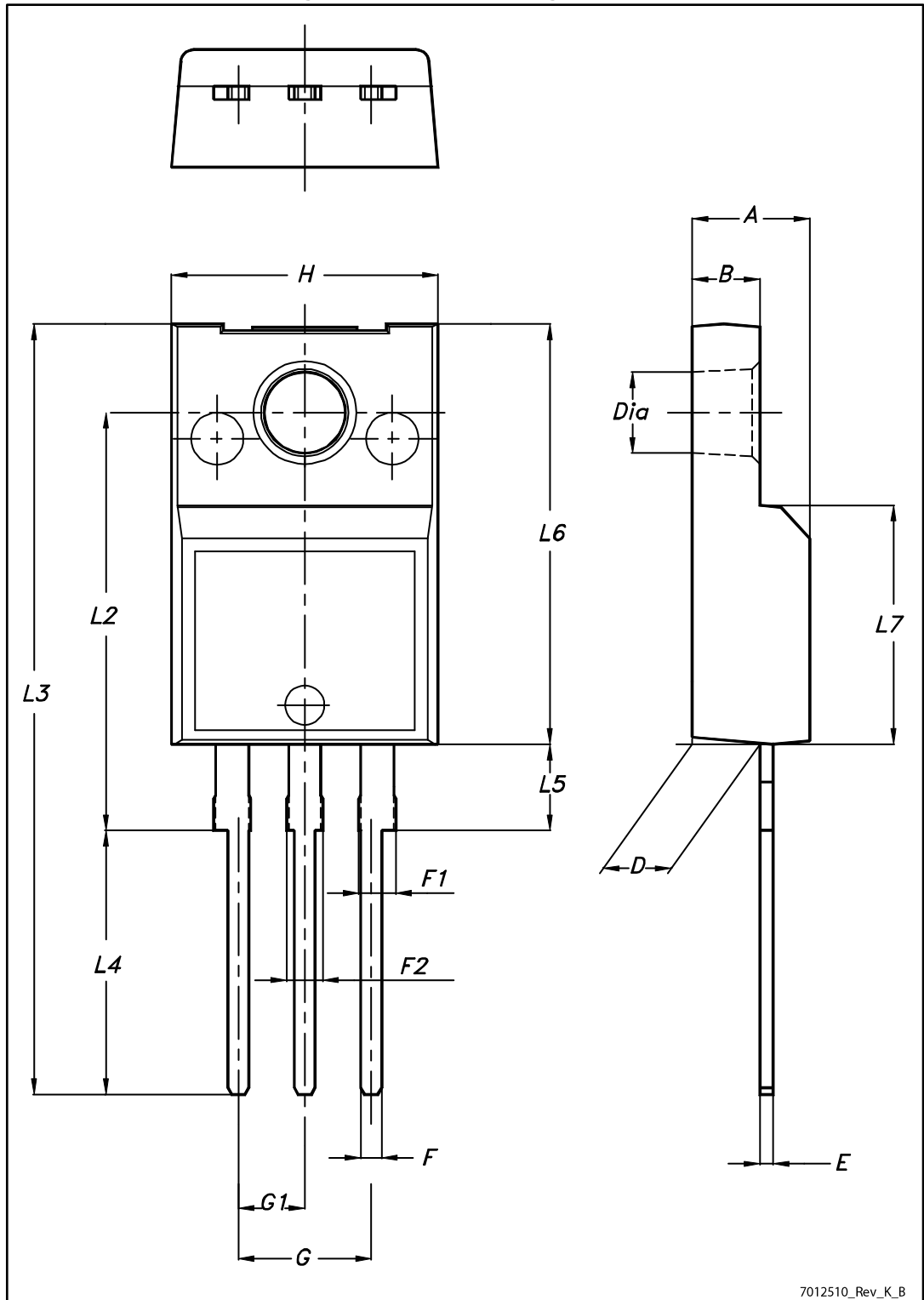

7012510\_Rev\_K\_B

Table 9: TO-220FP package mechanical data

| Dim. | mm   |      |      |
|------|------|------|------|
|      | Min. | Typ. | Max. |
| A    | 4.4  |      | 4.6  |
| B    | 2.5  |      | 2.7  |
| D    | 2.5  |      | 2.75 |
| E    | 0.45 |      | 0.7  |
| F    | 0.75 |      | 1    |
| F1   | 1.15 |      | 1.70 |
| F2   | 1.15 |      | 1.70 |
| G    | 4.95 |      | 5.2  |
| G1   | 2.4  |      | 2.7  |
| H    | 10   |      | 10.4 |
| L2   |      | 16   |      |
| L3   | 28.6 |      | 30.6 |
| L4   | 9.8  |      | 10.6 |
| L5   | 2.9  |      | 3.6  |
| L6   | 15.9 |      | 16.4 |
| L7   | 9    |      | 9.3  |
| Dia  | 3    |      | 3.2  |

## 5 Revision history

Table 10: Document revision history

| Date        | Revision | Changes  |
|-------------|----------|--|
| 13-Dec-2016 | 1        | First release. Part number previously included in datasheet DocID15642 |

**IMPORTANT NOTICE – PLEASE READ CAREFULLY**

STMicroelectronics NV and its subsidiaries ("ST") reserve the right to make changes, corrections, enhancements, modifications, and improvements to ST products and/or to this document at any time without notice. Purchasers should obtain the latest relevant information on ST products before placing orders. ST products are sold pursuant to ST's terms and conditions of sale in place at the time of order acknowledgement.

Purchasers are solely responsible for the choice, selection, and use of ST products and ST assumes no liability for application assistance or the design of Purchasers' products.

No license, express or implied, to any intellectual property right is granted by ST herein.

Resale of ST products with provisions different from the information set forth herein shall void any warranty granted by ST for such product.

ST and the ST logo are trademarks of ST. All other product or service names are the property of their respective owners.

Information in this document supersedes and replaces information previously supplied in any prior versions of this document.

© 2016 STMicroelectronics – All rights reserved



Компания «ЭлектроПласт» предлагает заключение долгосрочных отношений при поставках импортных электронных компонентов на взаимовыгодных условиях!

Наши преимущества:

- Оперативные поставки широкого спектра электронных компонентов отечественного и импортного производства напрямую от производителей и с крупнейших мировых складов;
- Поставка более 17-ти миллионов наименований электронных компонентов;
- Поставка сложных, дефицитных, либо снятых с производства позиций;
- Оперативные сроки поставки под заказ (от 5 рабочих дней);
- Экспресс доставка в любую точку России;
- Техническая поддержка проекта, помощь в подборе аналогов, поставка прототипов;
- Система менеджмента качества сертифицирована по Международному стандарту ISO 9001;
- Лицензия ФСБ на осуществление работ с использованием сведений, составляющих государственную тайну;
- Поставка специализированных компонентов (Xilinx, Altera, Analog Devices, Intersil, Interpoint, Microsemi, Aeroflex, Peregrine, Syfer, Eurofarad, Texas Instrument, Miteq, Cobham, E2V, MA-COM, Hittite, Mini-Circuits, General Dynamics и др.);

Помимо этого, одним из направлений компании «ЭлектроПласт» является направление «Источники питания». Мы предлагаем Вам помощь Конструкторского отдела:

- Подбор оптимального решения, техническое обоснование при выборе компонента;
- Подбор аналогов;
- Консультации по применению компонента;
- Поставка образцов и прототипов;
- Техническая поддержка проекта;
- Защита от снятия компонента с производства.



#### Как с нами связаться

**Телефон:** 8 (812) 309 58 32 (многоканальный)

**Факс:** 8 (812) 320-02-42

**Электронная почта:** [org@eplast1.ru](mailto:org@eplast1.ru)

**Адрес:** 198099, г. Санкт-Петербург, ул. Калинина, дом 2, корпус 4, литера А.