

## X-SP3T(DP6T) SWITCH GaAs MMIC

### ■ GENERAL DESCRIPTION

The NJG1655ME7 is a GaAs X (cross) - SP3T\*(DP6T) switch MMIC, which is designed for switching of balanced signals. The NJG1655ME7 features very low phase error between on-state paths, low insertion loss, low control voltage and wide frequency coverage. The ESD protection circuit are integrated in the IC to achieve high ESD tolerance.

The NJG1655ME7 is available in a very small, lead-free, halogen-free, 2.0mm x 2.0mm x 0.397 mm, 18-pin EQFN18-E7 package.

\*) X-SP3T is a paired SP3T switch controlled synchronously. The X-SP3T includes two SP3T switches whose RF lines have a crossing inside the chip.

### ■ PACKAGE OUTLINE

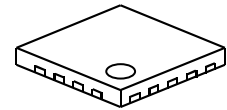

NJG1655ME7

### ■ APPLICATIONS

Switching of balanced type filters (Triple band) application  
Suitable for 3G and LTE application

### ■ FEATURES

- Low voltage operation  $V_{DD}=+1.5\sim+4.5V$
- Low voltage logic control  $V_{CTL(H)}=+1.3V$  min.
- Low insertion loss
  - 0.40dB typ. @ f=1.0GHz
  - 0.45dB typ. @ f=2.0GHz
- Operating current consumption 20 $\mu$ A typ. @  $V_{DD}=2.7V$
- Low phase error  $\pm 3$  deg @ f=2.0GHz
- Small package EQFN18-E7 (Package size: 2.0mm x 2.0mm x 0.397mm typ.)
- Integrated ESD protection circuit
- Lead-free, RoHs compliant and halogen-free

### ■ PIN CONFIGURATION

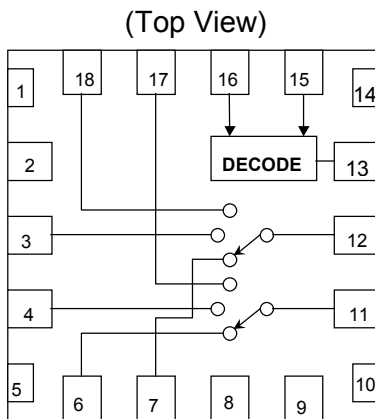

#### Pin connection

- |            |           |
|------------|-----------|
| 1. GND     | 11. PCB   |
| 2. NC(GND) | 12. PCA   |
| 3. P2A     | 13. VDD   |
| 4. P2B     | 14. GND   |
| 5. GND     | 15. VCTL2 |
| 6. P1B     | 16. VCTL1 |
| 7. P1A     | 17. P3B   |
| 8. GND     | 18. P3A   |
| 9. NC(GND) |           |
| 10. GND    |           |

### ■ TRUTH TABLE

"H"= $V_{CTL(H)}$ , "L"= $V_{CTL(L)}$

ON PATH	VCTL1	VCTL2
PCA-P1A PCB-P1B	H	L
PCA-P2A PCB-P2B	L	L
PCA-P3A PCB-P3B	L	H

NOTE: The information on this datasheet is subject to change without notice.

# NJG1655ME7

## ■ ABSOLUTE MAXIMUM RATINGS

( $T_a=+25^{\circ}\text{C}$ ,  $Z_s=Z_l=50\Omega$ )

PARAMETER	SYMBOL	CONDITIONS	RATINGS	UNITS
RF Input Power	$P_{IN}$	$V_{DD}=2.7\text{V}$ , $V_{CTL}=0\text{V}/1.8\text{V}$	28	dBm
Supply Voltage	$V_{DD}$	VDD terminal	5.0	V
Control Voltage	$V_{CTL}$	VCTL1, VCTL2 terminal	5.0	V
Power Dissipation	$P_D$	Four-layer FR4 PCB with through-hole (74.2mmx74.2mm), $T_j=150^{\circ}\text{C}$	1400	mW
Operating Temp.	$T_{opr}$		-40~+85	$^{\circ}\text{C}$
Storage Temp.	$T_{stg}$		-55~+150	$^{\circ}\text{C}$

## ■ ELECTRICAL CHARACTERISTICS

(General conditions:  $T_a=+25^{\circ}\text{C}$ ,  $Z_s=Z_l=50\Omega$ ,  $V_{DD}=2.7\text{V}$ ,  $V_{CTL(L)}=0\text{V}$ ,  $V_{CTL(H)}=1.8\text{V}$ , with application circuit)

PARAMETERS	SYMBOL	CONDITIONS	MIN	TYP	MAX	UNITS
Supply Voltage	$V_{DD}$		1.5	2.7	4.5	V
Operating Current	$I_{DD}$		-	20	40	$\mu\text{A}$
Control Voltage (LOW)	$V_{CTL(L)}$		0	-	0.4	V
Control Voltage (HIGH)	$V_{CTL(H)}$		1.3	1.8	4.5	V
Control Current	$I_{CTL}$		-	5	10	$\mu\text{A}$
Insertion Loss 1	LOSS1	$f=1.0\text{GHz}$ , $P_{IN}=0\text{dBm}$	-	0.40	0.55	dB
Insertion Loss 2	LOSS2	$f=2.0\text{GHz}$ , $P_{IN}=0\text{dBm}$	-	0.45	0.70	dB
Isolation 1	ISL1	$f=1.0\text{GHz}$ , $P_{IN}=0\text{dBm}$ PCA-P1A,P2A,P3A, PCB-P1B,P2B,P3B	24	27	-	dB
Isolation 2	ISL2	$f=2.0\text{GHz}$ , $P_{IN}=0\text{dBm}$ PCA-P1A,P2A,P3A, PCB-P1B,P2B,P3B	18	21	-	dB
Isolation 3	ISL3	$f=2.0\text{GHz}$ , $P_{IN}=0\text{dBm}$ PCA-PCB	15	18	-	dB
Phase Error	PE	$f=2\text{GHz}$	-3	-	3	deg
Input Power at 0.2dB Compression Point	$P_{-0.2\text{dB}}$	$f=2\text{GHz}$	18	23	-	dBm
VSWR	VSWR	$f=2\text{GHz}$ , on state	-	1.1	1.3	
Switching Time	$T_{sw}$	50% $V_{CTL}$ to 10%/90% RF	-	2	5	$\mu\text{s}$

## ■ TERMINAL INFORMATION

No.	SYMBOL	DESCRIPTION
1, 5, 8 10, 14,	GND	Ground terminal. Connect to the PCB ground plane.
2, 9	NC(GND)	No connected terminal. This terminal is not connected with internal circuit. Connect to the PCB ground plane.
3	P2A	The 2nd RF port of the 1st switch. This port is connected with PCA port. PCB port is connected with P2B port at the same time. An external capacitor is required to block DC voltage.
4	P2B	The 2nd RF port of the 2nd switch. This port is connected with PCB port. PCA port is connected with P2A port at the same time. An external capacitor is required to block DC voltage.
6	P1B	The 1st RF port of the 2nd switch. This port is connected with PCB port. PCA port is connected with P1A port at the same time. An external capacitor is required to block DC voltage.
7	P1A	The 1st RF port of the 1st switch. This port is connected with PCA port. PCB port is connected with P1B port at the same time. An external capacitor is required to block DC voltage.
11	PCB	Common RF port of the 2nd switch. This port is connected with either of P1B, P2B, and P3B port. An external capacitor is required to block DC voltage.
12	PCA	Common RF port of the 1st switch. This port is connected with either of P1A, P2A, and P3A port. An external capacitor is required to block DC voltage.
13	VDD	Positive voltage supply terminal. The positive voltage (+1.5~+4.5V) should be supplied. Please connect a bypass capacitor with GND terminal for best RF performance.
15	VCTL2	Control signal input terminal. This terminal is set to High-Level (+1.3V~4.5V) or Low-Level (0~+0.4V).
16	VCTL1	Control signal input terminal. This terminal is set to High-Level (+1.3V~4.5V) or Low-Level (0~+0.4V).
17	P3B	The 3rd RF port of the 2nd switch. This port is connected with PCB port. PCA port is connected with P3A port at the same time. An external capacitor is required to block DC voltage.
18	P3A	The 3rd RF port of the 1st switch. This port is connected with PCA port. PCB port is connected with P3B port at the same time. An external capacitor is required to block DC voltage.

# NJG1655ME7

## ■ ELECTRICAL CHARACTERISTICS (Losses of external circuit are excluded, with application circuit)

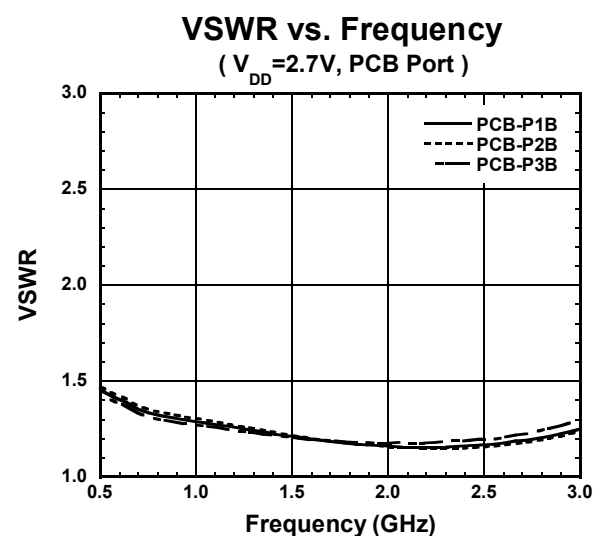
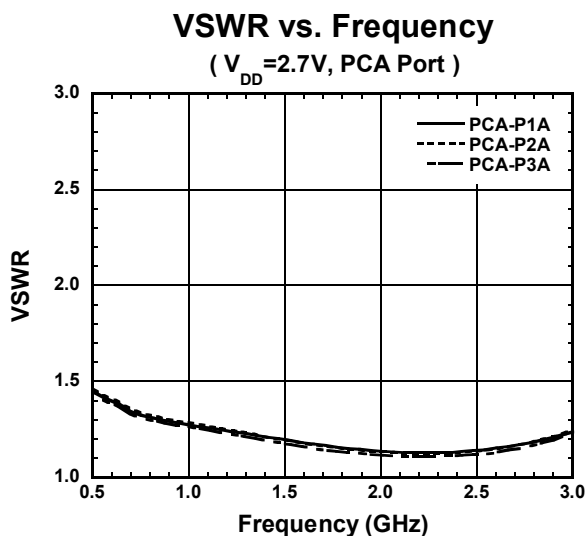
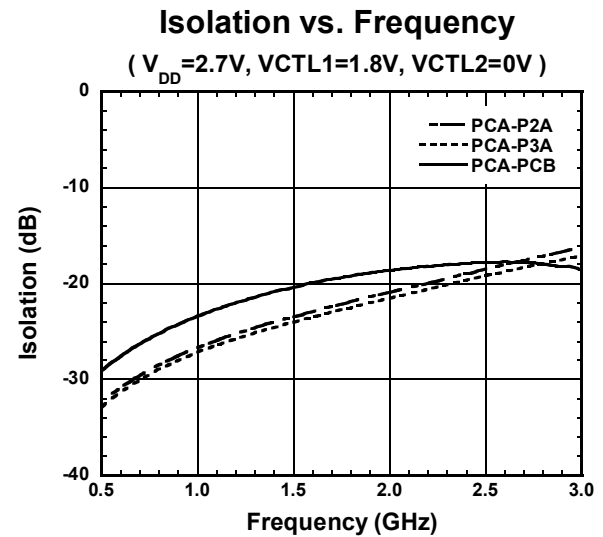
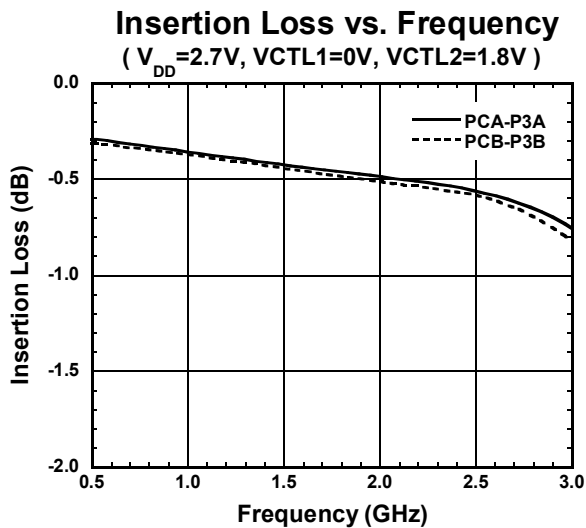
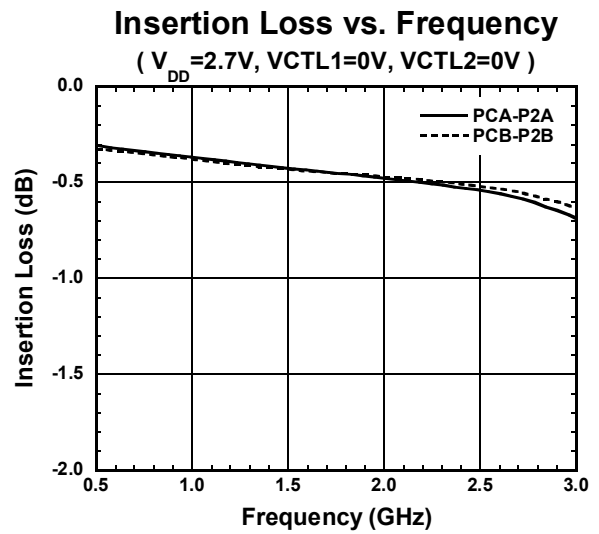
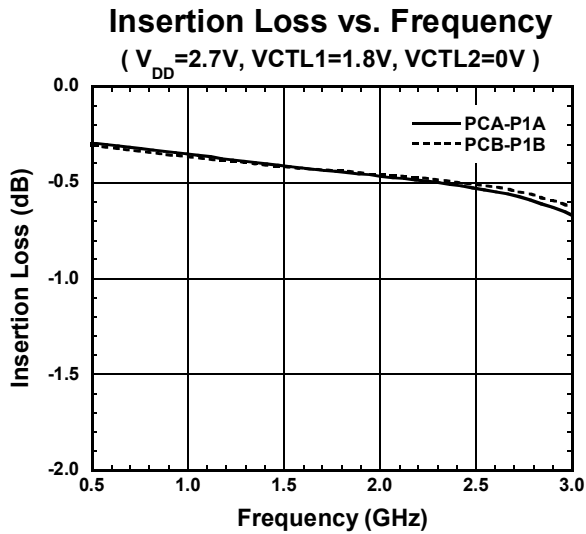

## ELECTRICAL CHARACTERISTICS (Losses of external circuit are excluded, with application circuit)

### Phase Error vs. Frequency

( $V_{DD}=2.7V$ )

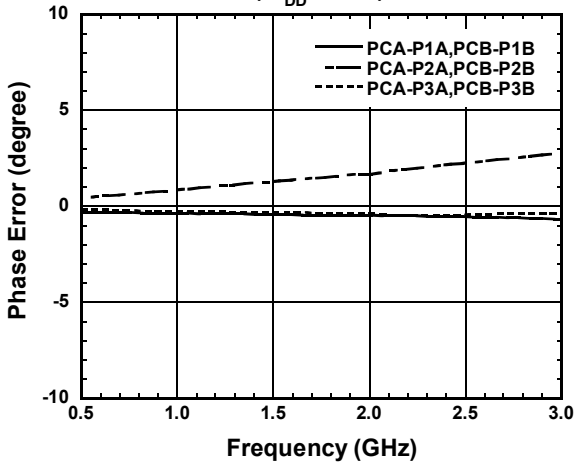

### Insertion Loss, $I_{DD}$ vs. Input Power

( $V_{DD}=2.7V, f=2GHz, V_{CTL1}=1.8V, V_{CTL2}=0V$ )

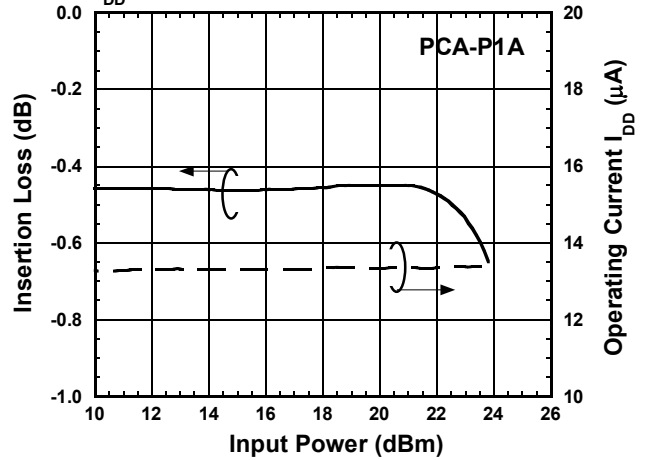

### P-0.2dB vs. $V_{DD}$

( $f=2GHz, V_{CTL1}=1.8V, V_{CTL2}=0V$ )

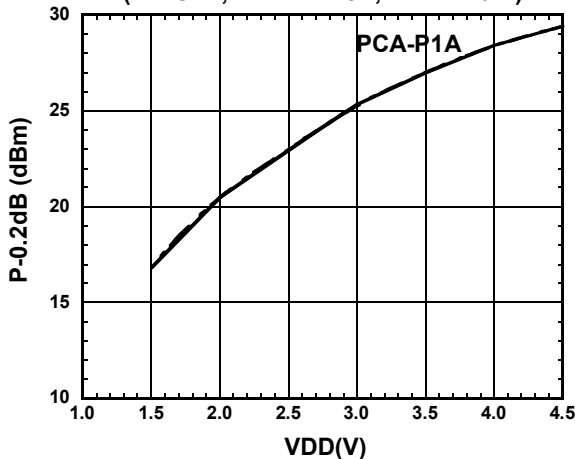

### P-0.2dB vs. $V_{CTL}$

( $f=2GHz, V_{DD}=2.7V, V_{CTL2}=0V$ )

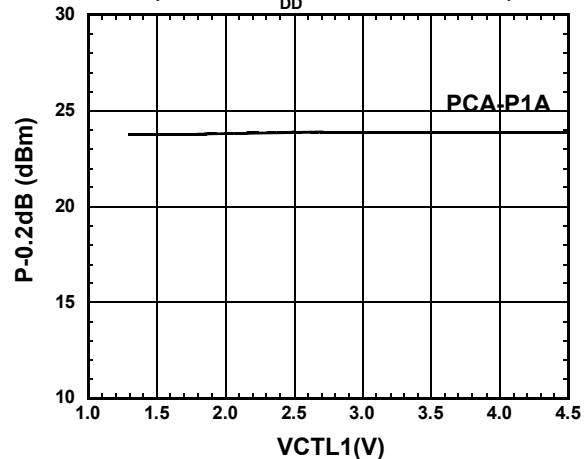

### Switching Time

( $V_{DD}=2.7V, V_{CTL2}=0V$ )

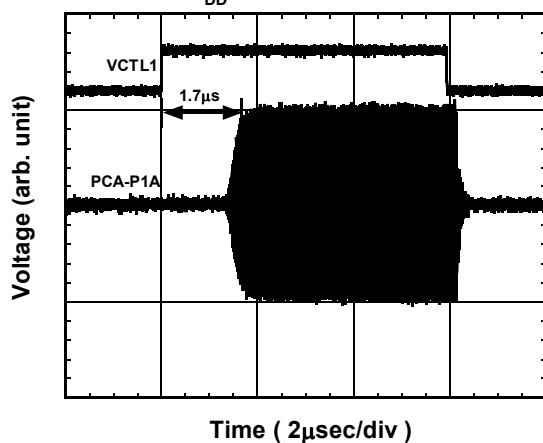

# NJG1655ME7

## ELECTRICAL CHARACTERISTICS (Losses of external circuit are excluded, with application circuit)

**Insertion Loss vs. Ambient Temperature**

( $V_{DD}=2.7V$ ,  $f=1GHz$ ,  $V_{CTL1}=1.8V$ ,  $V_{CTL2}=0V$ )

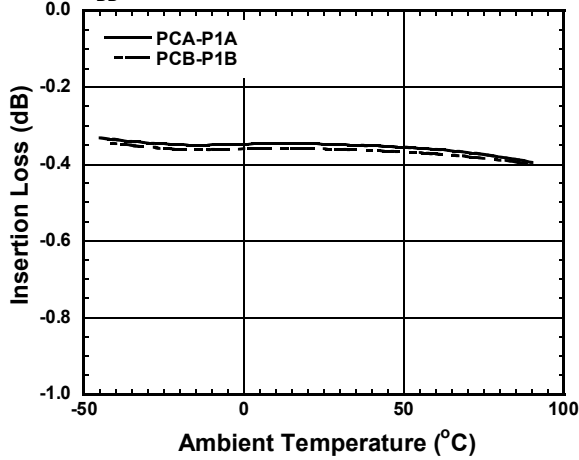

**Insertion Loss vs. Ambient Temperature**

( $V_{DD}=2.7V$ ,  $f=2GHz$ ,  $V_{CTL1}=1.8V$ ,  $V_{CTL2}=0V$ )

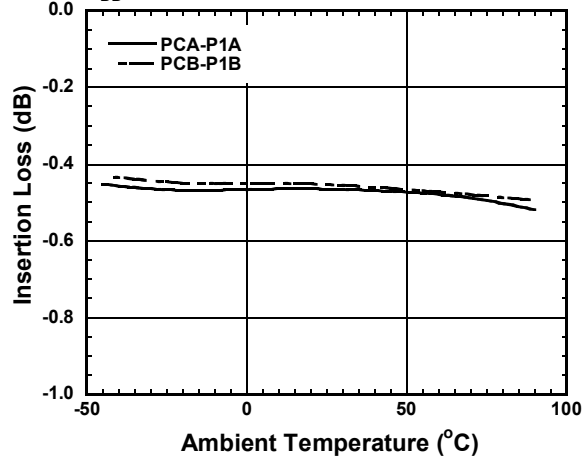

**Insertion Loss vs. Frequency**

( $V_{DD}=2.7V$ ,  $V_{CTL1}=1.8V$ ,  $V_{CTL2}=0V$ )

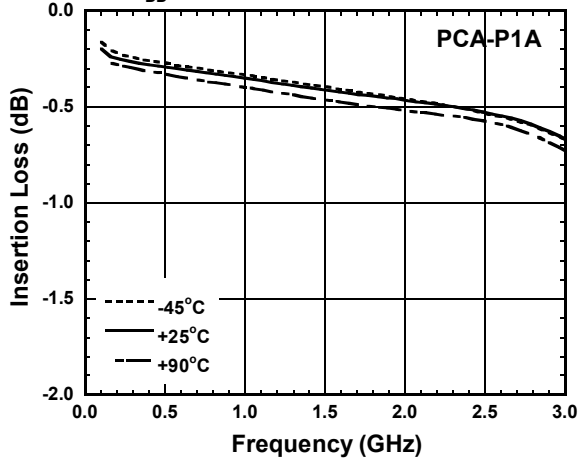

**Isolation vs. Ambient Temperature**

( $V_{DD}=2.7V$ ,  $f=2GHz$ ,  $V_{CTL1}=1.8V$ ,  $V_{CTL2}=0V$ )

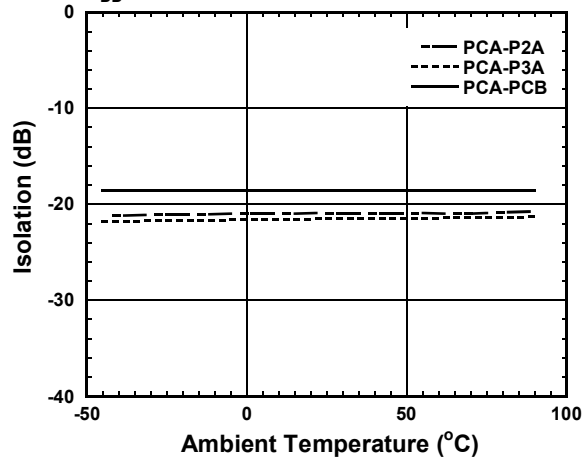

**VSWR vs. Ambient Temperature**

( $V_{DD}=2.7V$ ,  $f=2GHz$ , PCA Port)

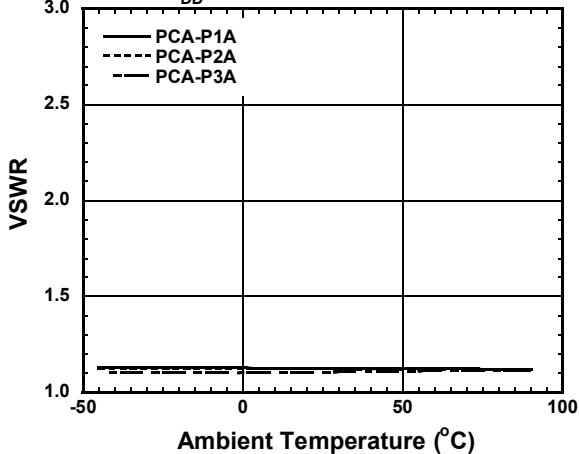

**VSWR vs. Ambient Temperature**

( $V_{DD}=2.7V$ ,  $f=2GHz$ , PCB Port)

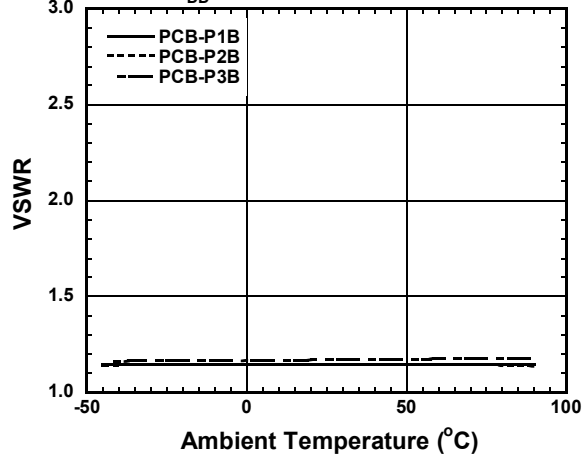

## ■ ELECTRICAL CHARACTERISTICS (Losses of external circuit are excluded, with application circuit)

### Phase Error vs. Ambient Temperature

( $V_{DD}=2.7V$ ,  $f=2GHz$ )

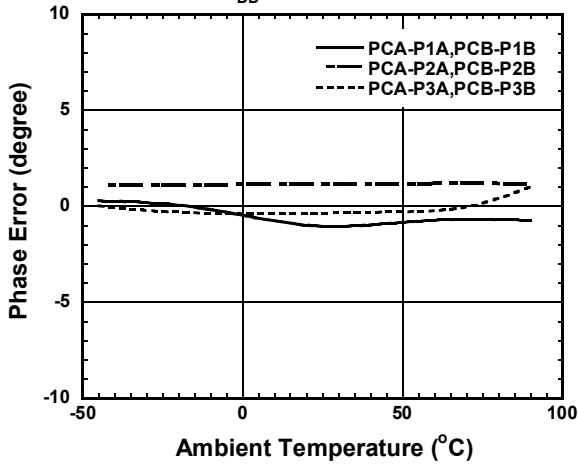

### Phase Error vs. Frequency

( $V_{DD}=2.7V$ ,  $f=2GHz$ ,  $V_{CTL1}=1.8V$ ,  $V_{CTL2}=0V$ )

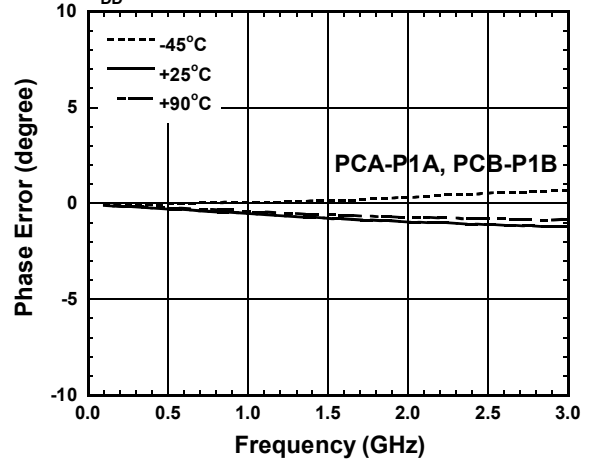

### P-0.2dB vs. Ambient Temperature

( $V_{DD}=2.7V$ ,  $f=2GHz$ ,  $V_{CTL1}=1.8V$ ,  $V_{CTL2}=0V$ )

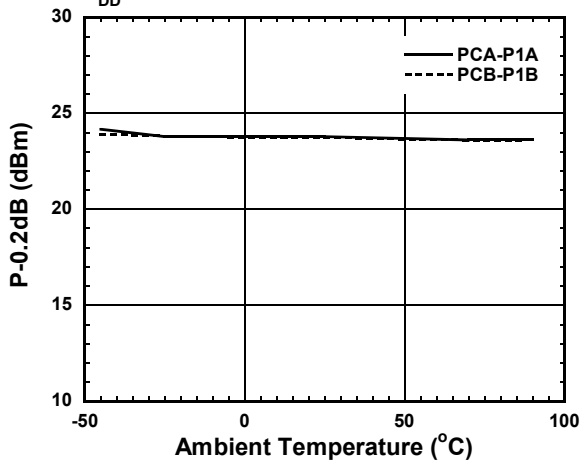

### P-0.2dB vs. Ambient Temperature

( $f=2GHz$ ,  $V_{DD}=2.7V$ ,  $V_{CTL2}=0V$ )

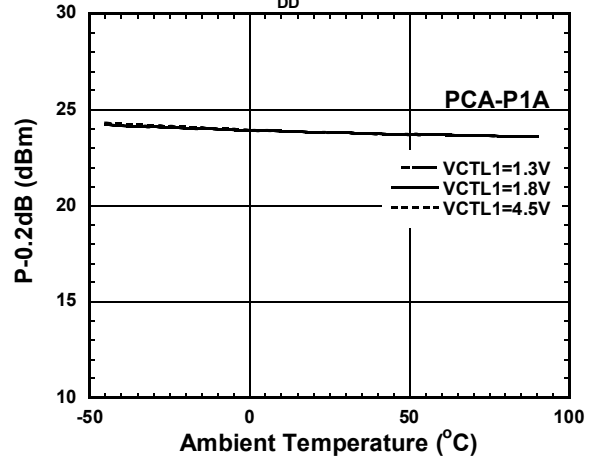

### Switching Time vs. Ambient Temperature

( $V_{DD}=2.7V$ ,  $V_{CTL2}=0V$ )

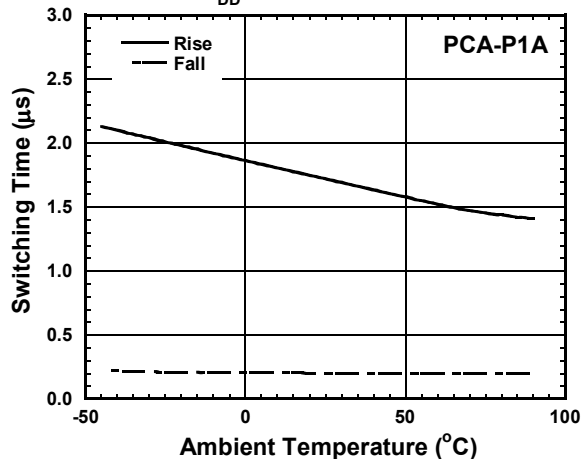

# NJG1655ME7

## APPLICATION CIRCUIT

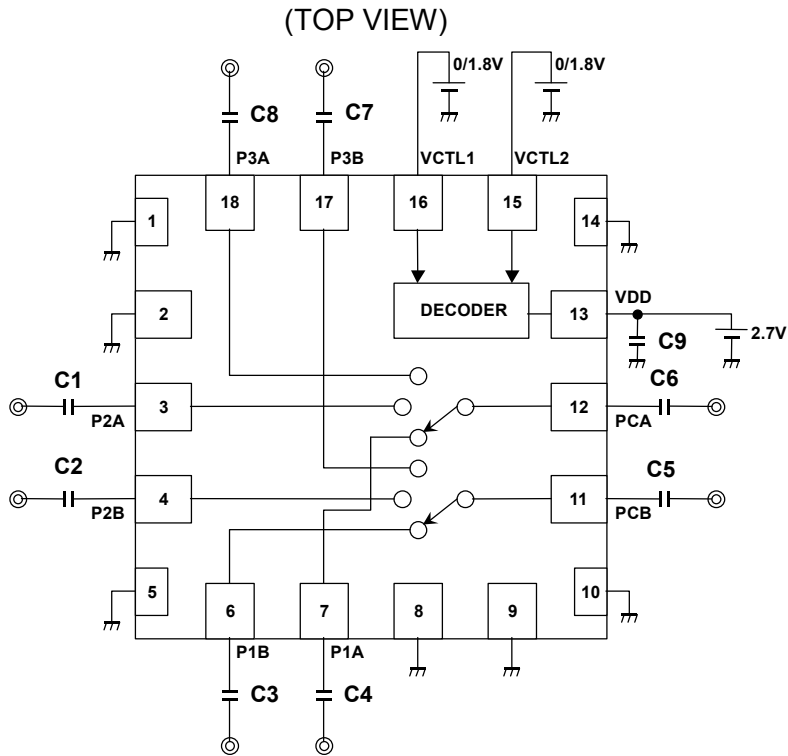

## PARTS LIST

PART ID	Value	Notes
C1~C8	56pF	MURATA (GRM15)
C9	1000pF	

## TEST PCB LAYOUT

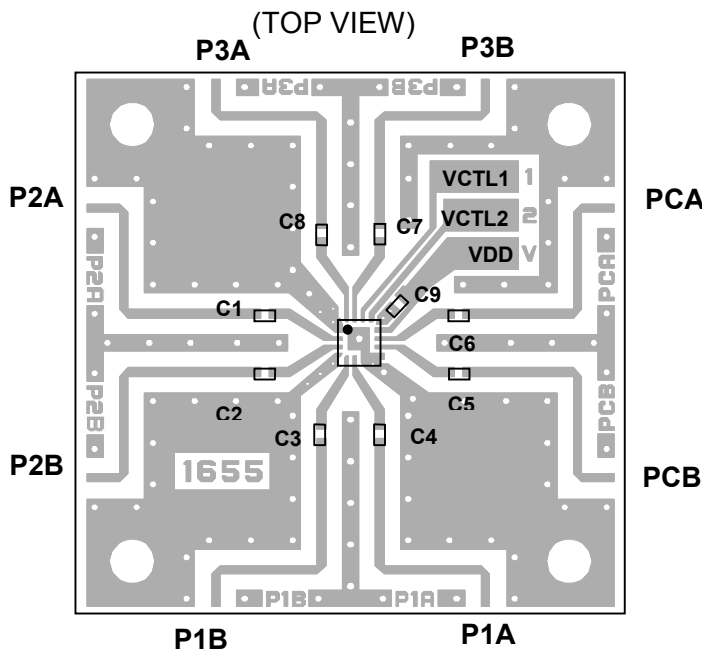

Losses of PCB, capacitors and connectors

Frequency	Loss
1GHz	0.36dB
2GHz	0.49dB

## PRECAUTIONS

- [1] The DC blocking capacitors (C1~C8) must be placed at all RF terminals (PCA, PCB, P1A, P1B, P2A, P2B, P3A and P3B).
- [2] The bypass capacitor (C9) should be placed as close as VDD terminal.
- [3] Please layout ground pattern right under this IC to avoid degradation of isolation or high power characteristics.





# Mouser Electronics

Authorized Distributor

Click to View Pricing, Inventory, Delivery & Lifecycle Information:

[NJR:](#)

[NJG1655ME7-TE1](#)



Компания «ЭлектроПласт» предлагает заключение долгосрочных отношений при поставках импортных электронных компонентов на взаимовыгодных условиях!

Наши преимущества:

- Оперативные поставки широкого спектра электронных компонентов отечественного и импортного производства напрямую от производителей и с крупнейших мировых складов;
- Поставка более 17-ти миллионов наименований электронных компонентов;
- Поставка сложных, дефицитных, либо снятых с производства позиций;
- Оперативные сроки поставки под заказ (от 5 рабочих дней);
- Экспресс доставка в любую точку России;
- Техническая поддержка проекта, помощь в подборе аналогов, поставка прототипов;
- Система менеджмента качества сертифицирована по Международному стандарту ISO 9001;
- Лицензия ФСБ на осуществление работ с использованием сведений, составляющих государственную тайну;
- Поставка специализированных компонентов (Xilinx, Altera, Analog Devices, Intersil, Interpoint, Microsemi, Aeroflex, Peregrine, Syfer, Eurofarad, Texas Instrument, Miteq, Cobham, E2V, MA-COM, Hittite, Mini-Circuits, General Dynamics и др.);

Помимо этого, одним из направлений компании «ЭлектроПласт» является направление «Источники питания». Мы предлагаем Вам помощь Конструкторского отдела:

- Подбор оптимального решения, техническое обоснование при выборе компонента;
- Подбор аналогов;
- Консультации по применению компонента;
- Поставка образцов и прототипов;
- Техническая поддержка проекта;
- Защита от снятия компонента с производства.



#### Как с нами связаться

**Телефон:** 8 (812) 309 58 32 (многоканальный)

**Факс:** 8 (812) 320-02-42

**Электронная почта:** [org@eplast1.ru](mailto:org@eplast1.ru)

**Адрес:** 198099, г. Санкт-Петербург, ул. Калинина, дом 2, корпус 4, литера А.