

LUXEON Z Colors

High-power color LEDs in a micro footprint package for ultimate design flexibility

LUXEON Z Colors is a broad portfolio of LEDs that enable never before seen lumen density, flexibility and freedom of design. Available in the full spectrum of colors from 440nm to 670nm, including Lime enabling highly efficient color mixing by providing a convenient above-blackbody color point with optical standalone efficacy. LUXEON Z Colors are ideal for entertainment and stage lighting, indoor and outdoor architectural lighting, emergency vehicle lighting, remote phosphor applications and a wide spectrum of specialty lighting applications.

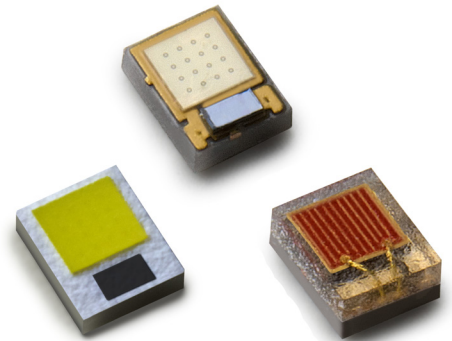

FEATURES AND BENEFITS

- Broad gamut, 440-670nm, including unique Lime color
- 2.2mm² footprint enables unique arrangements in space constrained applications
- 4-up RGBW pixel in 9.5mm² — four colors in less area than one regular high power color emitter
- Undomed design allows better optical management through collimated light output
- Enables customizable light sources: linear, rectangular, circular

PRIMARY APPLICATIONS

- Architectural
- Lamps
- Specialty Lighting

Table of Contents

General Information	2
Product Selection & Optical Characteristics	3
Flux Performance, Binning, and Supportability	4
Electrical Characteristics	6
Absolute Maximum Ratings	7
JEDEC Moisture Sensitivity	7
Reflow Soldering Characteristics	8
Mechanical Dimensions	9
Pad Configuration	12
Solder Pad Design	12
Wavelength Characteristics	13
Typical Light Output Characteristics	14
Typical Forward Current Characteristics	15
Typical Relative Luminous Flux	16
Typical Radiation Patterns:	17
Emitter Pocket Tape Packaging	20
Emitter Reel Packaging	22
Product Binning and Labeling	23
Luminous Flux Bins	24
Color Bins	25
Forward Voltage Bins	28

General Information

Part Number Nomenclature

LUXEON Z Color emitters are tested and binned at 25°C or 85°C, 500mA, depending on the product.

The part number designation for LUXEON Z Color LEDs is explained as follows:

L X Z 1 - A B C D - E F G H

Where:

- A — designates radiation pattern (value P for lambertian)
- B — designates color (see LUXEON Z color binning and labeling section)
- C — designates color variant (0 for color variants)
- D — designates color version (1, 2, etc.)
- E — open slot to accommodate additional requirements per product and part number
- FGH — (optional) minimum luminous flux (lm) or radiometric power (mW) performance

Please see DS120 for LUXEON Z White part number designation.

Product Selection & Optical Characteristics

Product Selection Guide for LUXEON Z Color Junction Temperature = 25°C

Table 1.

Color	Part Number	Performance @ 500mA		Performance @ 700mA	
		Minimum Luminous Flux (lm) or Radiometric Power (mW)	Typical Efficacy (lm/W) or Radiant Efficacy	Typical Luminous Flux (lm) or Radiometric Power (mW)	Typical Efficacy (lm/W) or Radiant Efficacy
Green	LXZ1-PM01	104	71	128	61
		96	63	120	53
		88	59	113	50
		80	54	103	46
Cyan	LXZ1-PE01	64	44	84	38
		56	39	74	33
		48	35	67	30
Blue	LXZ1-PB01	40	30	57	27
		32	26	49	23
		24	21	39	19
Royal Blue	LXZ1-PR01	600	43%	823	40%
		550	40%	757	37%
		500	37%	704	35%
Deep Red	LXZ1-PA01	350	34%	454	31%
		300	32%	416	29%
Red	LXZ1-PD01	56	54	77	49
		48	50	70	46
		40	42	60	38
Red-Orange	LXZ1-PH01	72	69	99	66
		64	63	90	58
		56	57	82	53
Amber	LXZ1-PL01	64	63	90	59
		56	57	82	53
		48	51	73	48

Notes for Table 1:

1. Minimum luminous flux or radiometric power performance guaranteed within published operating conditions. Lumileds maintains a tolerance of $\pm 6.5\%$ on flux and power measurements.
2. Typical luminous flux or radiometric power performance when device is operated within published operating conditions.

Product Selection & Optical Characteristics

Product Selection Guide for LUXEON Z Color Junction Temperature = 85°C

Table 2.

Color	Part Number	Binning Performance @ $I_f = 500\text{mA}$, $T_j = 85^\circ\text{C}$		Typical Performance @ $I_f = 700\text{mA}$, $T_j = 85^\circ\text{C}$	
		Minimum Luminous Flux (lm)	Typical Efficacy (lm/W)	Typical Luminous Flux (lm)	Typical Efficacy (lm/W)
Lime	LXZ1-PX01	194	136	255	128
		184	131	245	123
		174	124	233	117
		164	118	221	111
		154	113	212	106
		144	107	200	100
Red	LXZ1-PD02	48	47	69	42
		40	43	62	38
		32	36	53	32
		24	29	42	25
Red-Orange	LXZ1-PH02	56	53	77	47
		48	48	70	43
		40	41	59	36
Amber	LXZ1-PL03	32	32	46	29
		24	27	38	23
		16	21	30	18
PC Amber	LXZ1-PL02	104	73	135	66
		96	68	126	62
		88	65	119	59
		80	60	109	54
		72	54	99	49

Notes for Table 2:

1. Minimum luminous flux or radiometric power performance guaranteed within published operating conditions. Lumileds maintains a tolerance of $\pm 6.5\%$ on flux and power measurements.
2. Typical luminous flux or radiometric power performance when device is operated at specified conditions.
3. All products shown in Table 2 are tested and binned at $T_j = 85^\circ\text{C}$. All other LUXEON Z color emitters are tested and binned at $T_j = 25^\circ\text{C}$.

Flux Performance, Binning, and Supportability

LEDs are produced with semiconductor technology that is subject to process variation, yielding a range of flux performance that is approximately Gaussian in nature. In order to provide customers with fine granularity within the overall flux distribution, Lumileds separates LEDs into fixed, easy to design with, minimum luminous flux bins. To verify supportability of parts chosen for your application design, please consult your Lumileds sales representative.



Optical Characteristics

LUXEON Z Color at 500mA, Test Temperature

Table 3.

Color	Part Number	Dominant Wavelength ^[1] , λ_D or Peak Wavelength ^[2] , λ_P (nm)			Typical Spectral Half-width ^[3] (nm) $\Delta\lambda_{1/2}$	Typical Temp Coefficient of Dominant or Peak Wavelength (nm/°C) $\Delta\lambda_D / \Delta T_J$	Typical Total Included Angle ^[4] (degrees) $\theta_{90\%}$	Typical Viewing Angle ^[5] (degrees) $2\theta_{1/2}$
		Min	Typ	Max				
Green ^[6]	LXZ1-PM01	520.0	530.0	540.0	30	0.04	140	125
Cyan ^[6]	LXZ1-PE01	490.0	505.0	510.0	30	0.03	140	125
Blue ^[6]	LXZ1-PB01	460.0	470.0	480.0	20	0.03	140	125
Royal Blue ^{[2] [6]}	LXZ1-PR01	440.0	447.5	460.0	20	0.03	140	125
Red ^[7]	LXZ1-PD01	620.0	627.0	645.0	20	0.06	150	145
Red ^{[7] [8] [9]}	LXZ1-PD02	624.0	626.0	634.0	20	0.06	150	145
Deep Red ^[7]	LXZ1-PA01	650.0	655.0	670.0	20	0.06	150	145
Red-Orange ^[7]	LXZ1-PH01	610.0	617.0	620.0	20	0.06	150	145
Red-Orange ^{[7] [8] [9]}	LXZ1-PH02	614.0	619.0	624.0	20	0.06	150	145
Amber ^[7]	LXZ1-PL01	585.0	590.0	595.0	20	0.10	150	145
Amber ^{[7] [8] [9]}	LXZ1-PL03	594.0	597.0	604.0	20	0.10	150	145
PC Amber ^{[6] [8]}	LXZ1-PL02	588.0	590.0	592.0	80	0.01	140	125
Lime ^[8]	LXZ1-PX01	566.0	567.5	569.0	100	0.01	140	125

Notes for Table 3:

- Dominant wavelength is derived from the CIE 1931 Chromaticity diagram and represents the perceived color. Lumileds maintains a tolerance of ± 0.5 nm for dominant wavelength measurements.
- Royal Blue and Deep Red LEDs are binned by radiometric power and peak wavelength rather than photometric lumens. Lumileds maintains a tolerance of ± 2 nm for peak wavelength measurements.
- Spectral width at 1/2 of the peak intensity.
- Total angle at which 90% of total luminous flux is captured.
- Viewing angle is the off axis angle from lamp centerline where the luminous intensity is 1/2 of the peak value.
- Green, cyan, blue, royal blue, PC Amber, Lime and white products are built with Indium Gallium Nitride (InGaN).
- All red, deep red, red-orange, and amber are built with Aluminum Indium Gallium Phosphide (AlInGaP).
- LUXEON Z Lime, PC Amber and certain Red, Red-Orange and Amber emitters are tested and binned at $T_J = 85^\circ\text{C}$. All other LUXEON Z Color emitters are tested and binned at $T_J = 25^\circ\text{C}$.
- Wavelength ranges for hot tested Red, Red-Orange and Amber have been defined to align with typical changes in spectral output at increased temperature, which are inherent to AlInGaP LEDs. At $T_J = 25^\circ\text{C}$ these hot-tested parts will have the same typical spectral outputs as their cold-tested counterparts.

Electrical Characteristics

Electrical Characteristics for LUXEON Z Colors at Test Current and Temperature

Table 4.

Color	Part Number	Forward Voltage $V_f^{(1)}$ (V) @ 500mA			Typical Forward Voltage @ 700mA V_f	Typical Temperature Coefficient of Forward Voltage (mV/°C) $\Delta V_f / \Delta T_J$	Typical Thermal Resistance Junction to Case (°C/W) $R\theta_{J-C}$
		Minimum	Typical	Maximum			
Green	LXZ1-PM01	2.50	3.05	3.50	3.15	-2 to -4	5
Cyan	LXZ1-PE01	2.50	2.95	3.50	3.05	-2 to -4	5
Blue	LXZ1-PB01	2.50	3.15	3.50	3.25	-2 to -4	5
Royal Blue	LXZ1-PR01	2.50	2.90	3.50	2.95	-2 to -4	5
Red	LXZ1-PD01	1.75	2.20	2.75	2.40	-2 to -4	8
Red	LXZ1-PD02	1.75	2.15	2.75	2.35	-2 to -4	8
Deep Red	LXZ1-PA01	1.75	2.25	2.75	2.40	-2 to -4	8
Red-Orange	LXZ1-PH01	1.75	2.20	2.75	2.40	-2 to -4	8
Red-Orange	LXZ1-PH02	1.75	2.15	2.75	2.35	-2 to -4	8
Amber	LXZ1-PL01	1.75	2.15	2.75	2.35	-2 to -4	8
Amber	LXZ1-PL03	1.75	2.10	2.75	2.30	-2 to -4	8
PC Amber	LXZ1-PL02	2.50	2.85	3.50	2.90	-2 to -4	5
Lime	LXZ1-PX01	2.50	2.85	3.50	2.80	-2 to -4	5

Notes for Table 4:

1. Measured between $T_j = 25^\circ\text{C}$ and $T_j = 85^\circ\text{C}$ at $I_f = 500\text{mA}$.
2. Lumileds maintains a tolerance of $\pm 0.06\text{V}$ on forward voltage measurements.
3. LUXEON Z Lime, PC Amber and certain Red, Red-Orange and Amber emitters are tested and binned at $T_j = 85^\circ\text{C}$. All other LUXEON Z Color emitters are tested and binned at $T_j = 25^\circ\text{C}$.

Absolute Maximum Ratings

Table 5.

Parameter	Green/Cyan/ Blue/Royal Blue	Cold-Tested Red/ Deep-Red/Red- Orange/Amber	Hot-Tested Red/Red- Orange/Amber ^[2]	PC Amber/Lime
DC Forward Current (mA)	1000	700	1000/700	700
Peak Pulsed Forward Current (mA)	1000	700	1000/700	700
ESD Sensitivity	JESD22-A114-B			
LED Junction Temperature ^[1]	150°C	135°C	120°C/135°C	135°C
Operating Case Temperature at 500mA	-40°C - 135°C	-40°C - 120°C	-40°C - 120°C	-40°C - 110°C
Storage Temperature	-40°C - 135°C	-40°C - 135°C	-40°C - 120°C	-40°C - 135°C
Soldering Temperature	JEDEC 020c 260°C	JEDEC 020c 260°C	JEDEC 020c 260°C	JEDEC 020c 260°C
Allowable Reflow Cycles	3	3	3	3
Autoclave Conditions	121°C at 2 ATM	100% Relative Humidity for 96 Hours Maximum		
Reverse Voltage (V _r)	LUXEON Z Color Portfolio LEDs are not designed to be driven in reverse bias.			

Notes for Table 5:

- Proper current derating must be observed to maintain junction temperature below the maximum.
- Hot Tested LUXEON Z Red (LXZ1-PD02), Red-Orange (LXZ1-PH02) and Amber (LXZ1-PL03) products have two boundary points for maximum conditions:
I_f = 1A & T_j = 120°C or I_f = 700mA & T_j = 135°C.

JEDEC Moisture Sensitivity

Table 6.

Level	Floor Life		Soak Requirements	
			Standard	
	Time	Conditions	Time	Conditions
1	unlimited	≤ 30°C / 85% RH	168 Hrs. + 5 / -0 Hrs.	85°C / 85% RH

Reflow Soldering Characteristics



Temperature Profile for Table 7.

Table 7.

Profile Feature	Lead Free Assembly
Average Ramp-Up Rate ($T_{s_{max}}$ to T_p)	3°C / second max
Preheat Temperature Min ($T_{s_{min}}$)	150°C
Preheat Temperature Max ($T_{s_{max}}$)	200°C
Preheat Time ($t_{s_{min}}$ to $t_{s_{max}}$)	60 - 180 seconds
Temperature T_L (t_L)	217°C
Time Maintained Above Temperature T_L (t_L)	60 - 150 seconds
Peak / Classification Temperature (T_p)	260°C
Time Within 5°C of Actual Peak Temperature (t_p)	20 - 40 seconds
Ramp-Down Rate	6°C / second max
Time 25°C to Peak Temperature	8 minutes max

Note for Table 7:

1. All temperatures refer to the application Printed Circuit Board (PCB), measured on the surface adjacent to the package body.

Mechanical Dimensions

LUXEON Z Blue, Green, Royal Blue and Cyan

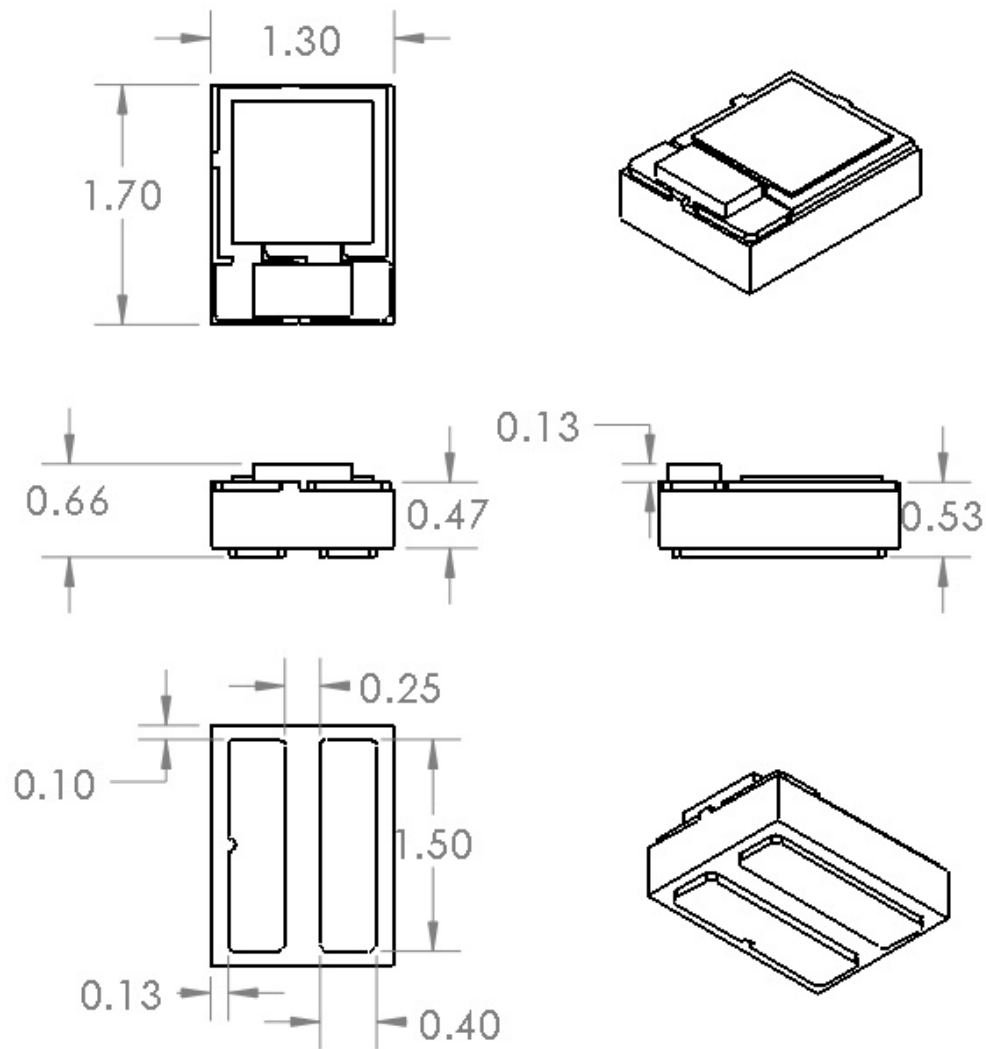

Figure 1. Package outline drawing for LXZ1-PR01, LXZ1-PB01, LXZ1-PE01 and LXZ1-PM01.

Notes for Figure 1:

1. To avoid damage, do not manually exert any force to the top surface. See AB105 for handling precautions.
2. Drawings not to scale.
3. All dimensions are in millimeters.

Mechanical Dimensions

LUXEON Z Lime and PC Amber

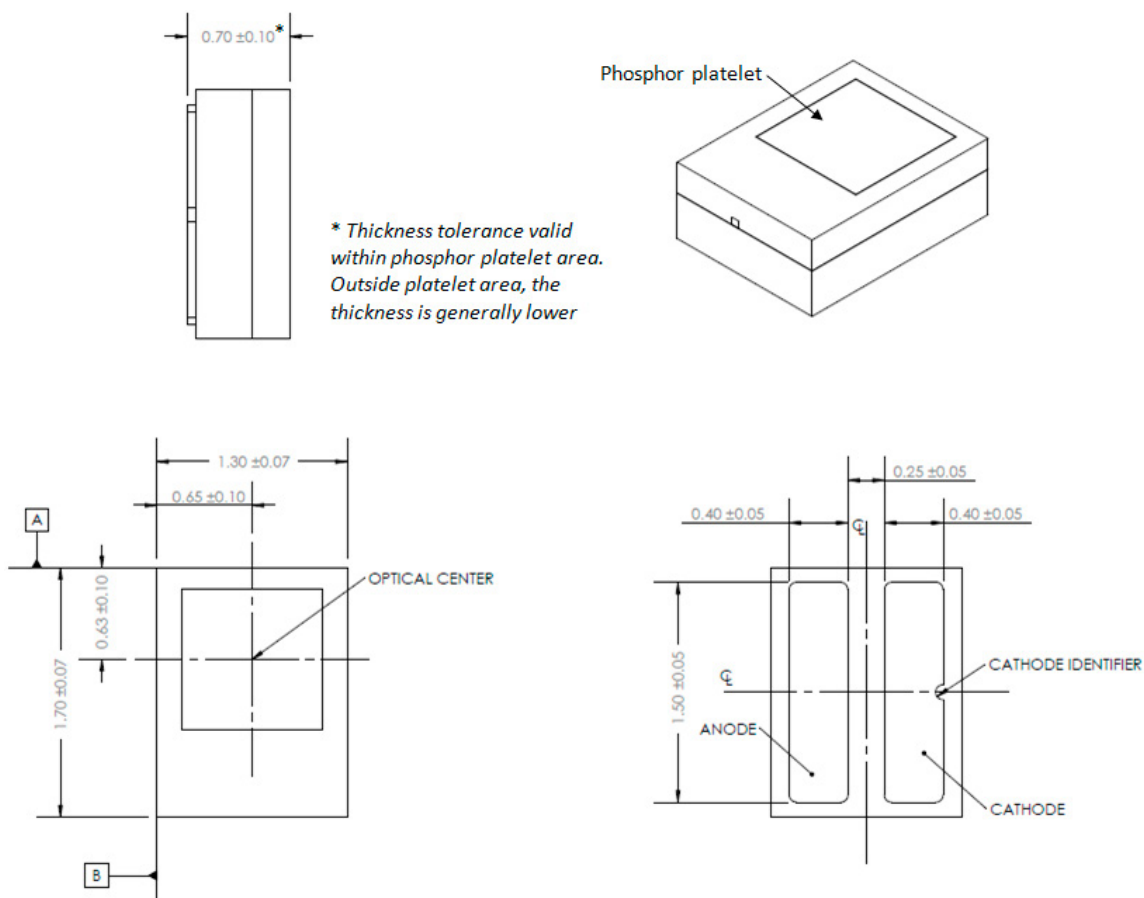

Figure 2. Package outline drawing for LXZ1-PX01 and LXZ1-PL02.

Notes for Figure 2:

1. To avoid damage, do not manually exert any force to the top surface. See AB105 for handling precautions.
2. Drawings not to scale.
3. All dimensions are in millimeters.

Mechanical Dimensions

LUXEON Z Red, Red-Orange, Amber and Deep Red



Figure 3. Package outline drawing for LXZ1-PL01, LXZ1-PA01, LXZ1-PD01 and LXZ1-PH01, LXZ1-PL03, LXZ1-PD02 and LXZ1-PH02.

Notes for Figure 3:

1. To avoid damage, do not manually exert any force to the top surface or handle from the sides of the silicone layer. See AB105 for handling precautions.
2. Drawings not to scale.
3. All dimensions are in millimeters.

Pad Configuration



Figure 4. Pad configuration.

Solder Pad Design



Figure 5. Solder pad layout.

Wavelength Characteristics

LUXEON Z Green, Cyan, Blue, Royal Blue, Red, Red-Orange and Amber at 500mA, 25°C

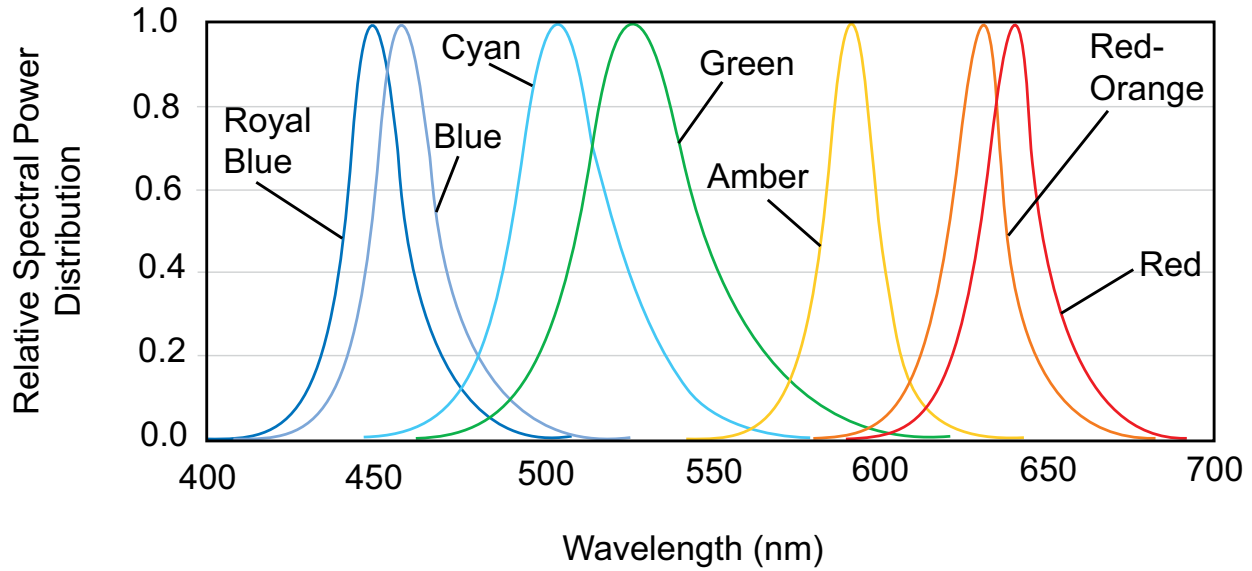

Figure 6. Relative intensity vs. wavelength.

LUXEON Z Lime and PC Amber at 500mA, 85°C

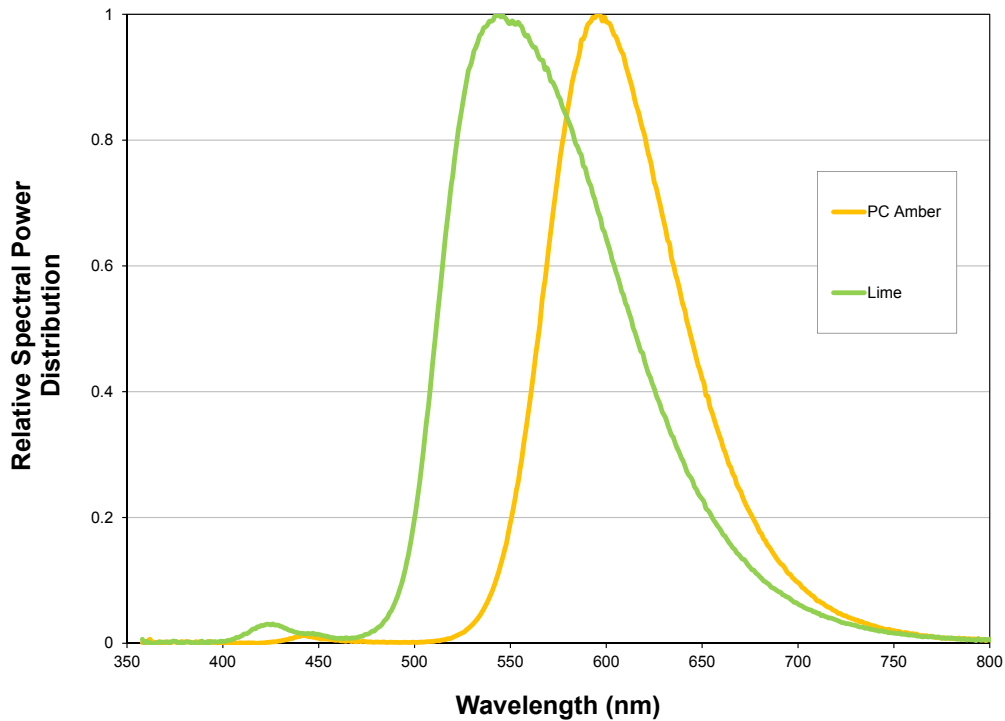

Figure 7. Relative intensity vs. wavelength.

Typical Light Output Characteristics

Relative Light Output vs. Thermal Pad Temperature, Test Current = 500mA



Figure 8. Relative light output vs. thermal pad temperature for LXZ1-PR01, LXZ1-PB01, LXZ1-PE01 and LXZ1-PM01.

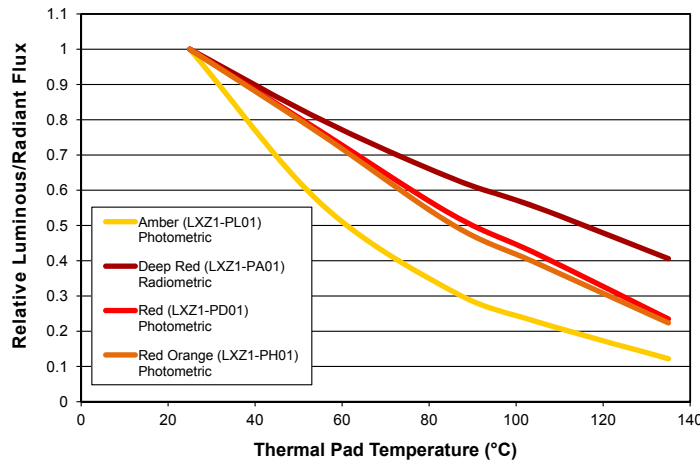

Figure 9. Relative light output vs. thermal pad temperature for LXZ1-PL01, LXZ1-PA01, LXZ1-PD01 and LXZ1-PH01.

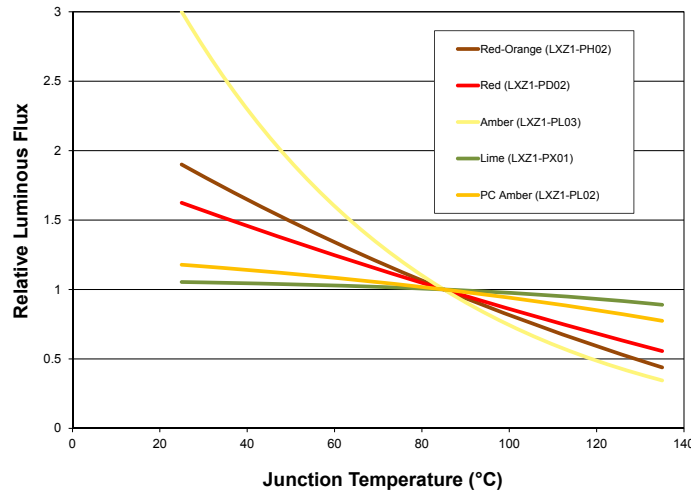

Figure 10. Relative light output vs. thermal pad temperature for LXZ1-PX01, LXZ1-PL02, LXZ1-PD02, LXZ1-PH02 and LXZ1-PL03.

Typical Forward Current Characteristics

Forward Current vs. Forward Voltage

Junction Temperature = 25°C

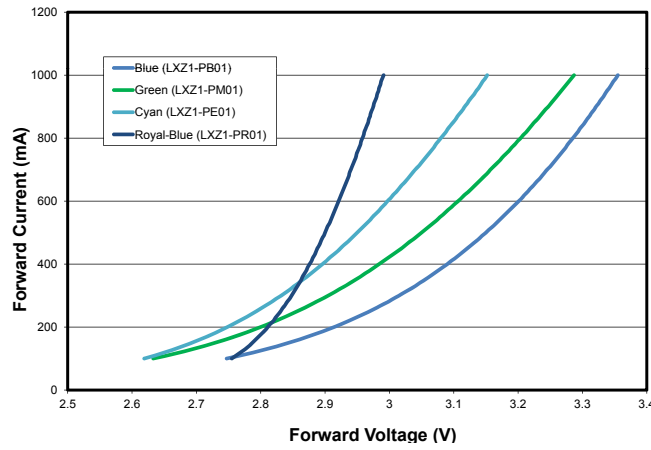

Figure 11. Forward current vs. forward voltage for LXZ1-PR01, LXZ1-PB01, LXZ1-PE01 and LXZ1-PM01.



Figure 12. Forward current vs. forward voltage for LXZ1-PL01, LXZ1-PA01, LXZ1-PD01 and LXZ1-PH01.

Forward Current vs. Forward Voltage

Junction Temperature = 85°C



Figure 13. Forward current vs. forward voltage for LXZ1-PX01, LXZ1-PL02, LXZ1-PD02, LXZ1-PH02, and LXZ1-PL03.

Typical Relative Luminous Flux

Relative Luminous Flux vs. Forward Current
Junction Temperature = 25°C



Figure 14. Relative luminous flux vs. forward current for LXZ1-PR01, LXZ1-PB01, LXZ1-PE01 and LXZ1-PM01.



Figure 15. Relative luminous flux vs. forward current for LXZ1-PL01, LXZ1-PA01, LXZ1-PD01 and LXZ1-PH01.

Relative Luminous Flux vs. Forward Current
Junction Temperature = 85°C



Figure 16. Relative luminous flux vs. forward current for LXZ1-PX01, LXZ1-PL02, LXZ1-PD02, LXZ1-PH02, and LXZ1-PL03.

Typical Radiation Patterns: LUXEON Z Green, Cyan, Blue and Royal Blue

Spatial Radiation Pattern



Figure 17. Typical spatial radiation pattern for LXZ1-PR01, LXZ1-PB01, LXZ1-PE01 and LXZ1-PM01.

Polar Radiation Pattern

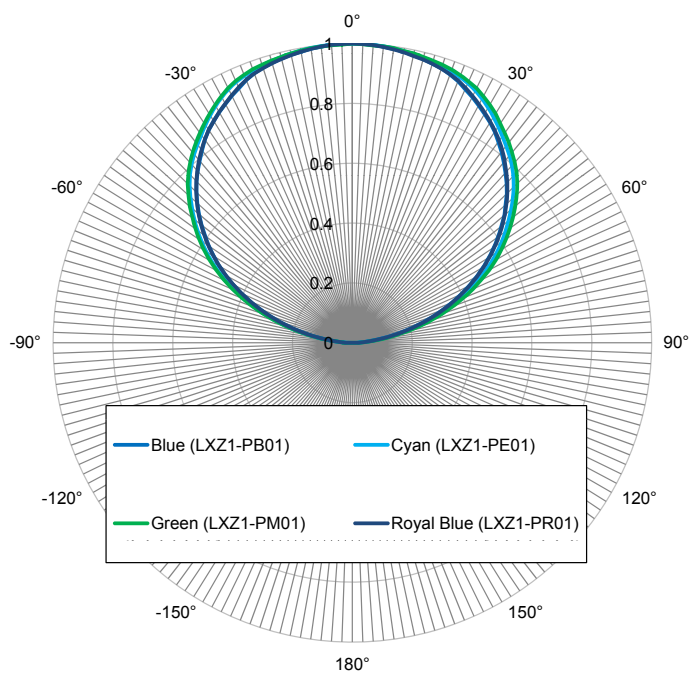

Figure 18. Typical polar radiation pattern for LXZ1-PR01, LXZ1-PB01, LXZ1-PE01 and LXZ1-PM01.

Typical Radiation Patterns: LUXEON Z Red, Red-Orange, Amber and Deep Red

Spatial Radiation Pattern

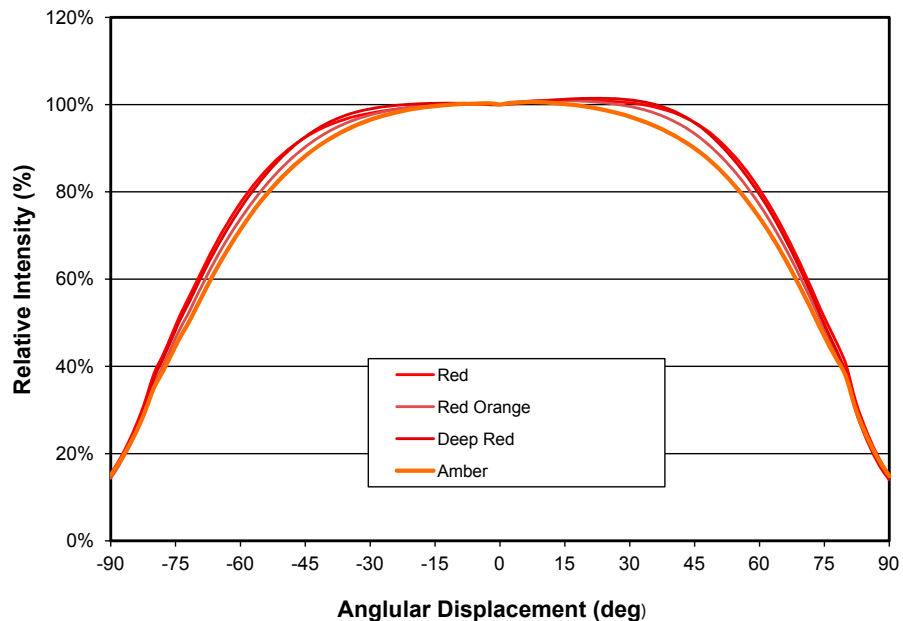

Figure 19. Spatial radiation pattern for LXZ1-PL01, LXZ1-PA01, LXZ1-PD01, LXZ1-PH01, LXZ1-PL03, LXZ1-PH02 and LXZ1-PD02.

Polar Radiation Pattern

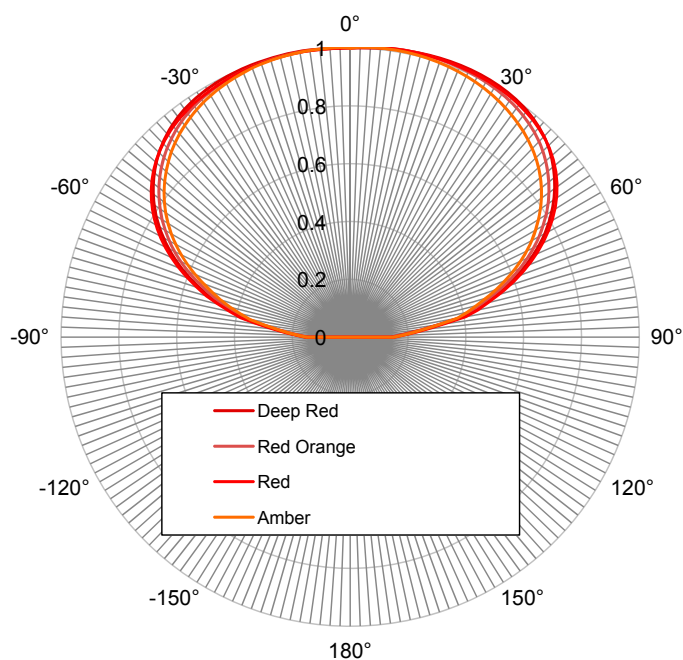

Figure 20. Typical polar radiation pattern for LXZ1-PL01, LXZ1-PA01, LXZ1-PD01 and LXZ1-PH01, LXZ1-PL03, LXZ1-PH02 and LXZ1-PD02.

Typical Radiation Patterns: LUXEON Z Lime and PC Amber

Spatial Radiation Pattern



Figure 21. Typical spatial radiation pattern for LXZ1-PX01 and LXZ1-PL02.

Polar Radiation Pattern



Figure 22. Typical polar radiation pattern for LXZ1-PX01 and LXZ1-PL02.

Emitter Pocket Tape Packaging

LUXEON Z Blue, Green, Royal Blue, Cyan, Lime and PC Amber



Figure 23. Emitter pocket tape packaging for LXZ1-PR01, LXZ1-PB01, LXZ1-PE01, LXZ1-PM01, LXZ1-PX01 and LXZ1-PL02.

Red, Red-Orange, Amber and Deep Red

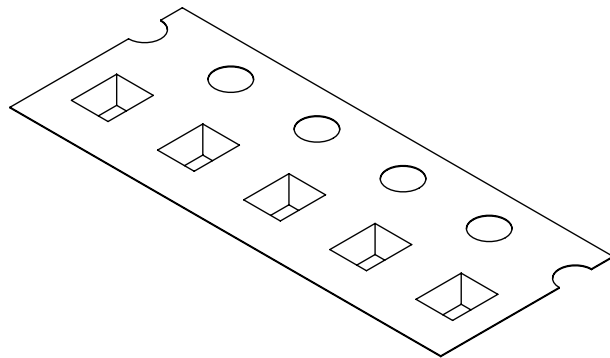

Figure 24. Emitter pocket tape packaging for LXZ1-PL01, LXZ1-PA01, LXZ1-PD01, LXZ1-PH01, LXZ1-PH02, LXZ1-PD02 and LXZ1-PL03.

Emitter Reel Packaging

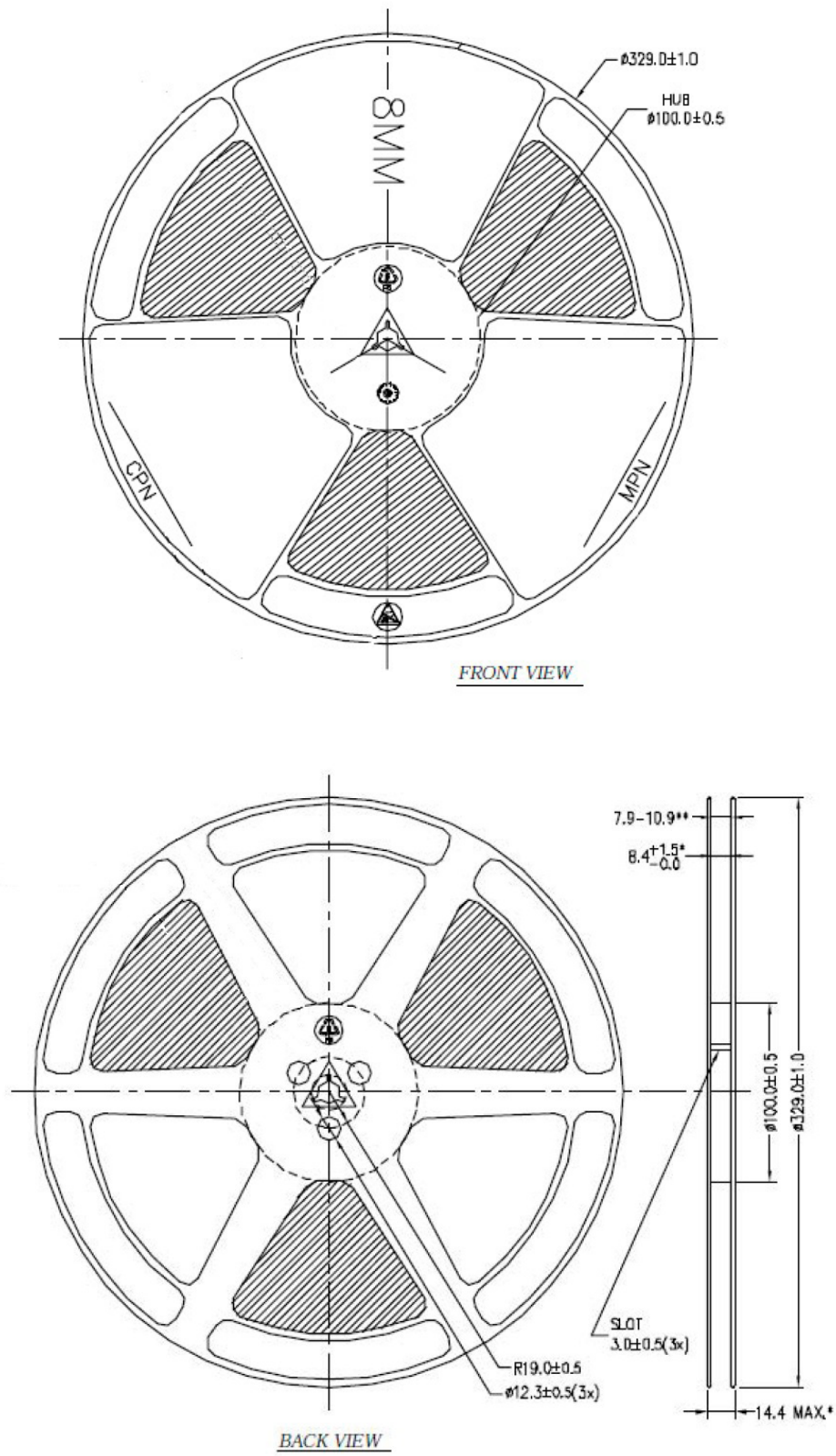

Figure 25. Emitter reel packaging.

Product Binning and Labeling

Purpose of Product Binning

In the manufacturing of semiconductor products, there is a variation of performance around the average values given in the technical data sheets. For this reason, Lumileds bins the LED components for luminous flux, color and forward voltage (V_f).

Decoding Product Bin Labeling

LUXEON Z Color Portfolio emitters are labeled using a three or four digit alphanumeric code (CAT code) depicting the bin values for emitters packaged on a single reel. All emitters packaged within a reel are of the same bin combination. Using these codes, it is possible to determine optimum mixing and matching of products for consistency in a given application.

Format of Labeling for Emitters

Reels of lime, green, cyan, blue, royal blue, red, red-orange, amber and deep red emitters are labeled with a three digit alphanumeric CAT code following the format below.

A B C

A = Flux bin (J, K, L, M, etc.)

B = Color bin (2, 4, 6, etc.)

C = V_f bin (4, 5, etc.)

Reels of PC Amber are labeled with the following CAT code format below.

A B C D

A = Flux bin (G, H, J etc.)

BC = Color bin (A1)

D = V_f bin (5, 6 etc.)

Luminous Flux Bins

Tables 8, 9 and 10 list the standard photometric luminous flux/radiometric power bins for LUXEON Z color emitters (tested and binned at 500mA). Although several bins are outlined, product availability in a particular bin varies by production run and by product performance. Not all bins are available in all colors.

Table 8. Luminous Flux Bins - All Colors excluding Hot Tested AlInGaP (LXZ1-PD02, LXZ1-PH02, LXZ1-PL03), Royal Blue and Deep Red

Bin Code	Minimum Flux (lm)	Maximum Flux (lm)
A	24	32
B	32	40
C	40	48
D	48	56
E	56	64
F	64	72
G	72	80
H	80	88
J	88	96
K	96	104
L	104	114
M	114	124
N	124	134
P	134	144
Q	144	154
R	154	164
S	164	174
T	174	184
U	184	194
V	194	204

Table 9. Radiometric Power Bins - Royal Blue (LXZ1-PR01) and Deep Red (LXZ1-PA01)

Bin Code	Minimum Radiometric Flux (mW)	Maximum Radiometric Flux (mW)
A	250	300
B	300	350
C	350	400
D	400	450
E	450	500
F	500	550
G	550	600
H	600	650
I	650	700

Table 10. Luminous Flux Bins - Hot Tested Red (LXZ1-PD02), Red Orange (LXZ1-PH02) and Amber (LXZ1-PL03)

Bin Code	Minimum Radiometric Flux (mW)	Maximum Radiometric Flux (mW)
A	16	24
B	24	32
C	32	40
D	40	48
E	48	56
F	56	64
G	64	72

Color Bins

Table 11. Dominant Wavelength Bin Structure for LUXEON Z Green (LXZ1-PM01)

Bin Code	Minimum Dominant Wavelength (nm)	Maximum Dominant Wavelength (nm)
1	520	525
2	525	530
3	530	535
4	535	540

Table 12. Dominant Wavelength Bin Structure for LUXEON Z Cyan (LXZ1-PE01)

Bin Code	Minimum Dominant Wavelength (nm)	Maximum Dominant Wavelength (nm)
1	490	498
2	498	508
6	490	495
7	495	500
8	500	505
9	505	510

Table 13. Dominant Wavelength Bin Structure for LUXEON Z Blue (LXZ1-PB01)

Bin Code	Minimum Dominant Wavelength (nm)	Maximum Dominant Wavelength (nm)
1	460	465
2	465	470
3	470	475
4	475	480
5	480	485

Table 14. Peak Wavelength Bin Structure for LUXEON Z Royal Blue (LXZ1-PR01)

Bin Code	Minimum Dominant Wavelength (nm)	Maximum Dominant Wavelength (nm)
3	440	445
4	445	450
5	450	455
6	455	460

Color Bins, Continued

Table 15. Dominant Wavelength Bin Structure for LUXEON Z Red (LXZ1-PD01)

Bin Code	Minimum Dominant Wavelength (nm)	Maximum Dominant Wavelength (nm)
4	620	630
5	630	640

Table 16. Dominant Wavelength Bin Structure for LUXEON Z Red-Orange (LXZ1-PH01)

Bin Code	Minimum Dominant Wavelength (nm)	Maximum Dominant Wavelength (nm)
2	610	620

Table 17. Dominant Wavelength Bin Structure for LUXEON Z Amber (LXZ1-PL01)

Bin Code	Minimum Dominant Wavelength (nm)	Maximum Dominant Wavelength (nm)
1	585	587
2	587	590
4	590	592
6	592	595

Table 18. Peak Wavelength Bin Structure for LUXEON Z Deep Red (LXZ1-PA01)

Bin Code	Minimum Dominant Wavelength (nm)	Maximum Dominant Wavelength (nm)
6	650	660
7	660	670

Table 19. Peak Wavelength Bin Structure for LUXEON Z Amber (LXZ1-PL03)^[1]

Bin Code	Minimum Dominant Wavelength (nm)	Maximum Dominant Wavelength (nm)
6	594	599
7	599	604

Table 20. Peak Wavelength Bin Structure for LUXEON Z Red-Orange (LXZ1-PH02)^[1]

Bin Code	Minimum Dominant Wavelength (nm)	Maximum Dominant Wavelength (nm)
2	614	624

Table 21. Peak Wavelength Bin Structure for LUXEON Z Red (LXZ1-PD02)^[1]

Bin Code	Minimum Dominant Wavelength (nm)	Maximum Dominant Wavelength (nm)
4	624	634

Notes for Tables 19, 20 and 21:

1. Wavelength ranges for hot tested Red, Red-Orange and Amber have been defined to align with typical changes in spectral output at increased temperature, which are inherent to AlInGaP technology. At $T_j = 25^\circ\text{C}$ these hot-tested parts will have the same typical spectral outputs as their cold-tested counterparts.

Color Bins, Continued

Table 22. Dominant Wavelength Bin Structure for LUXEON Z Lime (LXZ1-PX01) and PC Amber (LXZ1-PL02)

Color	Bin Code	x	y
Lime	1	0.3819	0.5055
		0.4191	0.5790
		0.4327	0.5655
		0.3972	0.4986
PC Amber	A1	0.5622	0.4372
		0.5576	0.4326
		0.5775	0.4132
		0.5843	0.4151



Figure 26. Color bin structure for LXZ1-PX01 and LXZ1-PL02.

Forward Voltage Bins

The following forward voltage bins include the minimum and maximum V_f bin values for the emitter. Although several bins are outlined, product availability in a particular bin varies by production run and by product performance.

Table 23. Voltage Bins

Bin Code	Minimum Forward Voltage (V)	Maximum Forward Voltage (V)
1	1.75	2.00
2	2.00	2.25
3	2.25	2.50
4	2.50	2.75
5	2.75	3.00
6	3.00	3.25
7	3.25	3.50

About Lumileds

Lumileds is the light engine leader, delivering innovation, quality, and reliability.

For 100 years, Lumileds commitment to innovation has helped customers pioneer breakthrough products in the automotive, consumer and illumination markets.

Lumileds is shaping the future of light with our LEDs and automotive lamps, and helping our customers illuminate how people see the world around them.

To learn more about our portfolio of light engines visit www.lumileds.com.



©2015 Lumileds Holding B.V. All rights reserved.
LUXEON is a registered trademark of the Lumileds Holding B.V.
in the United States and other countries.

www.lumileds.com

Lumileds Holding B.V. shall not be liable for any kind of loss of data or any other damages, direct, indirect or consequential, resulting from the use of the provided information and data. Although Lumileds Holding B.V. has attempted to provide the most accurate information and data, the materials and services information and data are provided "as is" and Lumileds Holding B.V. neither warranties, nor guarantees the contents and correctness of the provided information and data. Lumileds Holding B.V. reserves the right to make changes without notice. You as user agree to this disclaimer and user agreement with the download or use of the provided materials, information and data.



Компания «ЭлектроПласт» предлагает заключение долгосрочных отношений при поставках импортных электронных компонентов на взаимовыгодных условиях!

Наши преимущества:

- Оперативные поставки широкого спектра электронных компонентов отечественного и импортного производства напрямую от производителей и с крупнейших мировых складов;
- Поставка более 17-ти миллионов наименований электронных компонентов;
- Поставка сложных, дефицитных, либо снятых с производства позиций;
- Оперативные сроки поставки под заказ (от 5 рабочих дней);
- Экспресс доставка в любую точку России;
- Техническая поддержка проекта, помощь в подборе аналогов, поставка прототипов;
- Система менеджмента качества сертифицирована по Международному стандарту ISO 9001;
- Лицензия ФСБ на осуществление работ с использованием сведений, составляющих государственную тайну;
- Поставка специализированных компонентов (Xilinx, Altera, Analog Devices, Intersil, Interpoint, Microsemi, Aeroflex, Peregrine, Syfer, Eurofarad, Texas Instrument, Miteq, Cobham, E2V, MA-COM, Hittite, Mini-Circuits, General Dynamics и др.);

Помимо этого, одним из направлений компании «ЭлектроПласт» является направление «Источники питания». Мы предлагаем Вам помощь Конструкторского отдела:

- Подбор оптимального решения, техническое обоснование при выборе компонента;
- Подбор аналогов;
- Консультации по применению компонента;
- Поставка образцов и прототипов;
- Техническая поддержка проекта;
- Защита от снятия компонента с производства.



Как с нами связаться

Телефон: 8 (812) 309 58 32 (многоканальный)

Факс: 8 (812) 320-02-42

Электронная почта: org@eplast1.ru

Адрес: 198099, г. Санкт-Петербург, ул. Калинина, дом 2, корпус 4, литера А.