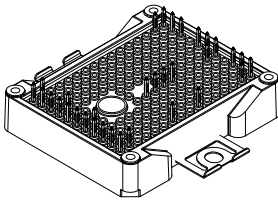
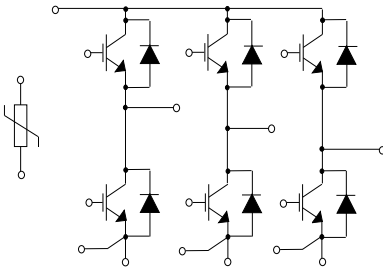

ACEPACK™ 2 sixpack topology, 1200 V, 75 A trench gate field-stop IGBT M series, soft diode and NTC

ACEPACK™ 2

Features

- ACEPACK™ 2 power module
 - DBC Cu Al₂O₃ Cu
- Sixpack topology
 - 1200 V, 75 A IGBTs and diodes
 - Soft and fast recovery diode
- Integrated NTC

Applications

- Inverters
- Industrial
- Motor drives

Description

This power module is a sixpack topology in an ACEPACK™ 2 package with NTC, integrating the advanced trench gate field-stop technologies from STMicroelectronics. This new IGBT technology represents the best compromise between conduction and switching loss, to maximize the efficiency of any converter system up to 20 kHz.

Product status

A2P75S12M3-F

Product summary

Order code	A2P75S12M3-F
Marking	A2P75S12M3-F
Package	ACEPACK™ 2
Leads type	Press fit contact pins

1 Electrical ratings

1.1 IGBT

Limiting values at $T_J = 25\text{ °C}$, unless otherwise specified.

Table 1. Absolute maximum ratings of the IGBT

Symbol	Parameter	Value	Unit
V_{CES}	Collector-emitter voltage ($V_{GE} = 0$)	1200	V
I_C	Continuous collector current ($T_C = 100\text{ °C}$)	75	A
$I_{CP}^{(1)}$	Pulsed collector current ($t_p = 1\text{ ms}$)	150	A
V_{GE}	Gate-emitter voltage	± 20	V
P_{TOT}	Total power dissipation of each IGBT ($T_C = 25\text{ °C}$, $T_J = 175\text{ °C}$)	454.5	W
T_{JMAX}	Maximum junction temperature	175	°C
T_{Jop}	Operating junction temperature range under switching conditions	-40 to 150	°C

1. Pulse width limited by maximum junction temperature.

Table 2. Electrical characteristics of the IGBT

Symbol	Parameter	Test conditions	Min.	Typ.	Max.	Unit	
$V_{(BR)CES}$	Collector-emitter breakdown voltage	$I_C = 1\text{ mA}$, $V_{GE} = 0\text{ V}$	1200			V	
$V_{CE(sat)}$ (terminal)	Collector-emitter saturation voltage	$V_{GE} = 15\text{ V}$, $I_C = 75\text{ A}$ $V_{GE} = 15\text{ V}$, $I_C = 75\text{ A}$, $T_J = 150\text{ °C}$		1.95 2.3	2.3	V	
$V_{GE(th)}$	Gate threshold voltage	$V_{CE} = V_{GE}$, $I_C = 1\text{ mA}$	5	6	7	V	
I_{CES}	Collector cut-off current	$V_{GE} = 0\text{ V}$, $V_{CE} = 1200\text{ V}$			100	μA	
I_{GES}	Gate-emitter leakage current	$V_{CE} = 0\text{ V}$, $V_{GE} = \pm 20\text{ V}$			± 500	nA	
C_{ies}	Input capacitance	$V_{CE} = 25\text{ V}$, $f = 1\text{ MHz}$, $V_{GE} = 0\text{ V}$		4700		pF	
C_{oes}	Output capacitance			350		pF	
C_{res}	Reverse transfer capacitance			190		pF	
Q_g	Total gate charge	$V_{CC} = 960\text{ V}$, $I_C = 75\text{ A}$, $V_{GE} = \pm 15\text{ V}$		350		nC	
$t_{d(on)}$	Turn-on delay time	$V_{CC} = 600\text{ V}$, $I_C = 75\text{ A}$, $R_G = 10\ \Omega$, $V_{GE} = \pm 15\text{ V}$, $di/dt = 1900\text{ A}/\mu\text{s}$		198		ns	
t_r	Current rise time			32		ns	
$E_{on}^{(1)}$	Turn-on switching energy			3.59		mJ	
$t_{d(off)}$	Turn-off delay time		$V_{CC} = 600\text{ V}$, $I_C = 75\text{ A}$, $R_G = 10\ \Omega$, $V_{GE} = \pm 15\text{ V}$, $dv/dt = 6000\text{ V}/\mu\text{s}$;		250		ns
t_f	Current fall time				159		ns
$E_{off}^{(2)}$	Turn-off switching energy			5.13		mJ	

Symbol	Parameter	Test conditions	Min.	Typ.	Max.	Unit
$t_{d(on)}$	Turn-on delay time	$V_{CC} = 600\text{ V}$, $I_C = 75\text{ A}$, $R_G = 10\ \Omega$, $V_{GE} = \pm 15\text{ V}$, $di/dt = 1718\text{ A}/\mu\text{s}$, $T_J = 150\text{ }^\circ\text{C}$		200		ns
t_r	Current rise time			35		ns
$E_{on}^{(1)}$	Turn-on switching energy				6.28	
$t_{d(off)}$	Turn-off delay time	$V_{CC} = 600\text{ V}$, $I_C = 75\text{ A}$, $R_G = 10\ \Omega$, $V_{GE} = \pm 15\text{ V}$, $dv/dt = 4900\text{ V}/\mu\text{s}$, $T_J = 150\text{ }^\circ\text{C}$		266		ns
t_f	Current fall time			251		ns
$E_{off}^{(2)}$	Turn-off switching energy				7.7	
t_{SC}	Short-circuit withstand time	$V_{CC} \leq 600\text{ V}$, $V_{GE} \leq 15\text{ V}$, $T_{Jstart} \leq 150\text{ }^\circ\text{C}$	10			μs
R_{THj-c}	Thermal resistance junction-to-case	Each IGBT		0.30	0.33	$^\circ\text{C}/\text{W}$
R_{THc-h}	Thermal resistance case-to-heatsink	Each IGBT, $\lambda_{grease} = 1\text{ W}/(\text{m}\cdot^\circ\text{C})$		0.60		$^\circ\text{C}/\text{W}$

1. Including the reverse recovery of the diode.
2. Including the tail of the collector current.

1.2 Diode

Limiting values at $T_J = 25\text{ }^\circ\text{C}$, unless otherwise specified.

Table 3. Absolute maximum ratings of the diode

Symbol	Parameter	Value	Unit
V_{RRM}	Repetitive peak reverse voltage	1200	V
I_F	Continuous forward current ($T_C = 100\text{ }^\circ\text{C}$)	75	A
$I_{FP}^{(1)}$	Pulsed forward current ($t_p = 1\text{ ms}$)	150	A
T_{JMAX}	Maximum junction temperature	175	$^\circ\text{C}$
T_{Jop}	Operating junction temperature range under switching conditions	-40 to 150	$^\circ\text{C}$

1. Pulse width limited by maximum junction temperature.

Table 4. Electrical characteristics of the diode

Symbol	Parameter	Test conditions	Min.	Typ.	Max.	Unit
V_F (terminal)	Forward voltage	$I_F = 75\text{ A}$	-	2.95	4.1	V
		$I_F = 75\text{ A}$, $T_J = 150\text{ }^\circ\text{C}$	-	2.3		
t_{rr}	Reverse recovery time	$I_F = 75\text{ A}$, $V_R = 600\text{ V}$, $V_{GE} = \pm 15\text{ V}$, $di/dt = 1900\text{ A}/\mu\text{s}$	-	200		ns
Q_{rr}	Reverse recovery charge		-	6.0		μC
I_{rrm}	Reverse recovery current		-	78		A
E_{rec}	Reverse recovery energy		-	2.2		mJ

Symbol	Parameter	Test conditions	Min.	Typ.	Max.	Unit
t_{rr}	Reverse recovery time	$I_F = 75\text{ A}$, $V_R = 600\text{ V}$, $V_{GE} = \pm 15\text{ V}$, $di/dt = 1718\text{ A}/\mu\text{s}$, $T_J = 150\text{ }^\circ\text{C}$	-	500		ns
Q_{rr}	Reverse recovery charge		-	12.5		μC
I_{rrm}	Reverse recovery current		-	90		A
E_{rec}	Reverse recovery energy		-	5.2		mJ
R_{THj-c}	Thermal resistance junction-to-case	Each diode	-	0.55	0.60	$^\circ\text{C}/\text{W}$
R_{THc-h}	Thermal resistance case-to-heatsink	Each diode, $\lambda_{grease} = 1\text{ W}/(\text{m}\cdot^\circ\text{C})$	-	0.75		$^\circ\text{C}/\text{W}$

1.3 NTC

Table 5. NTC temperature sensor, considered as stand-alone

Symbol	Parameter	Test conditions	Min.	Typ.	Max.	Unit
R_{25}	Resistance	$T = 25\text{ }^\circ\text{C}$		5		$\text{k}\Omega$
R_{100}	Resistance	$T = 100\text{ }^\circ\text{C}$		493		Ω
$\Delta R/R$	Deviation of R_{100}		-5		+5	%
$B_{25/50}$	B-constant			3375		K
$B_{25/80}$	B-constant			3411		K
T	Operating temperature range		-40		150	$^\circ\text{C}$

Figure 1. NTC resistance vs temperature

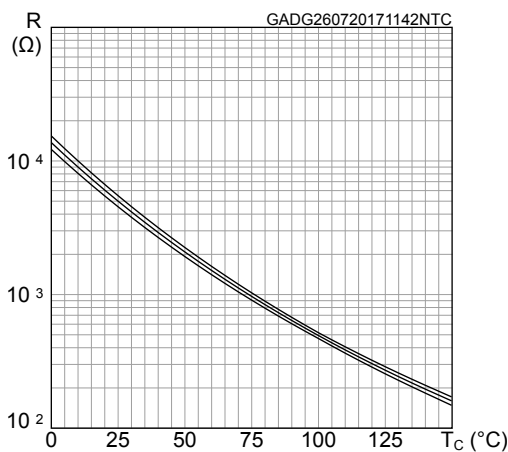
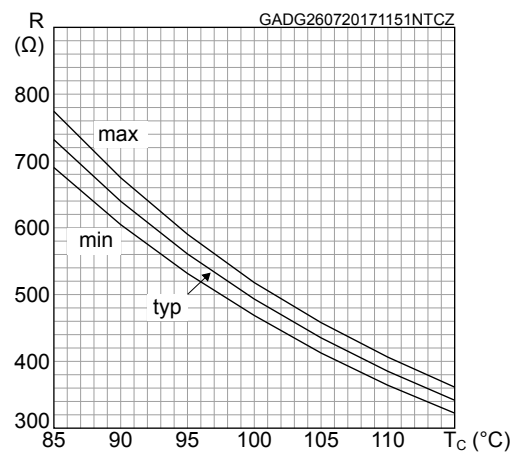

Figure 2. NTC resistance vs temperature, zoom



1.4 Package

Table 6. ACEPACK™ 2 package

Symbol	Parameter	Min.	Typ.	Max.	Unit
V _{isol}	Isolation voltage (AC voltage, t = 60 s)			2500	V
T _{stg}	Storage temperature	-40		125	°C
CTI	Comparative tracking index	200			
L _s	Stray inductance module P1 - EW loop		33.5		nH
R _s	Module single lead resistance, terminal to chip		3.6		mΩ

2 Electrical characteristics curves

Figure 3. IGBT output characteristics
($V_{GE} = 15\text{ V}$, terminal)

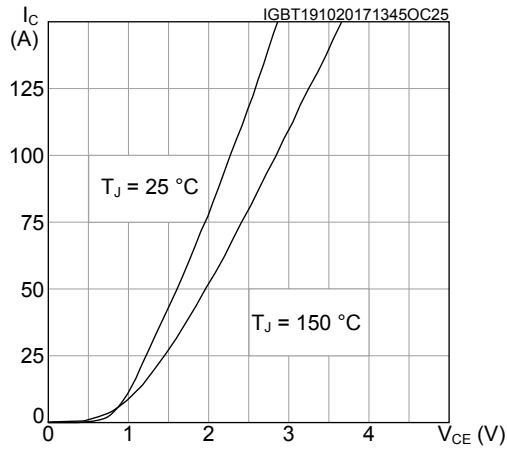

Figure 4. IGBT output characteristics
($T_J = 150\text{ °C}$, terminal)

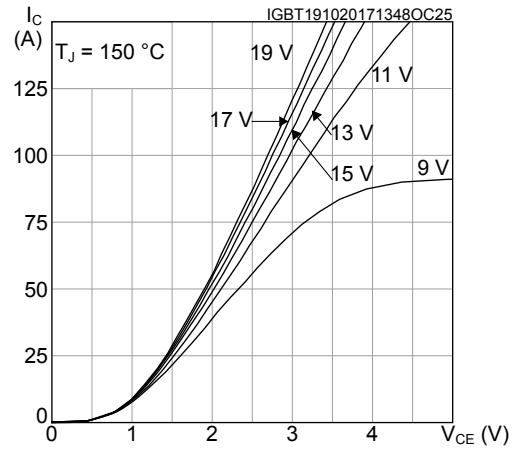

Figure 5. IGBT transfer characteristics
($V_{CE} = 15\text{ V}$, terminal)

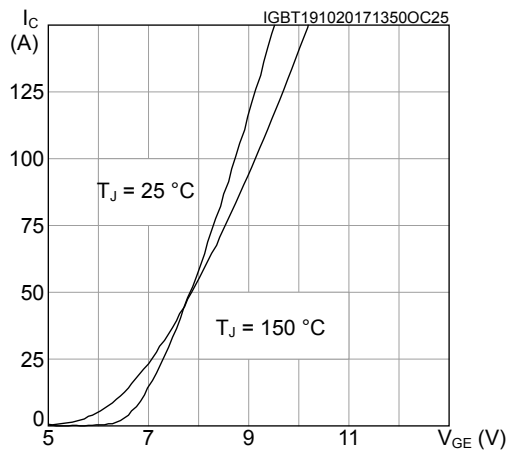

Figure 6. Switching energy vs gate resistance

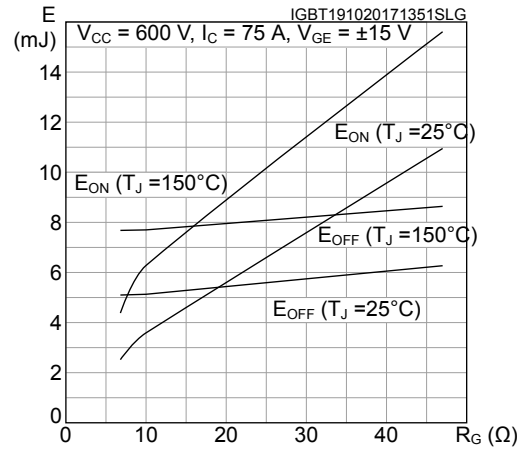

Figure 7. Switching energy vs collector current

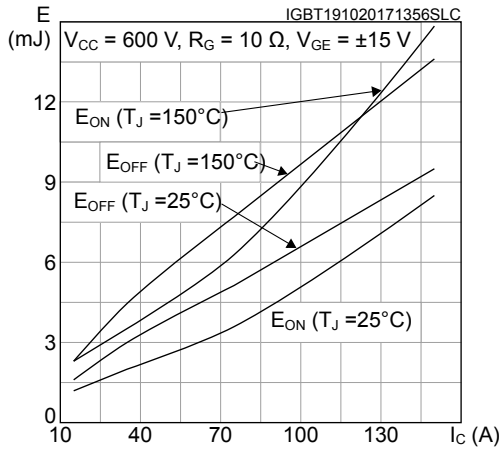

Figure 8. IGBT reverse biased safe operating area (RBSOA)

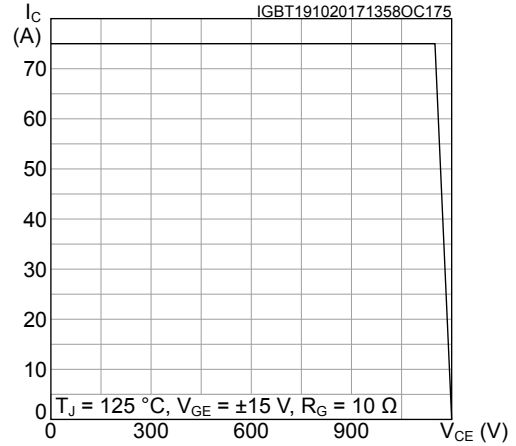

Figure 9. Diode forward characteristics (terminal)

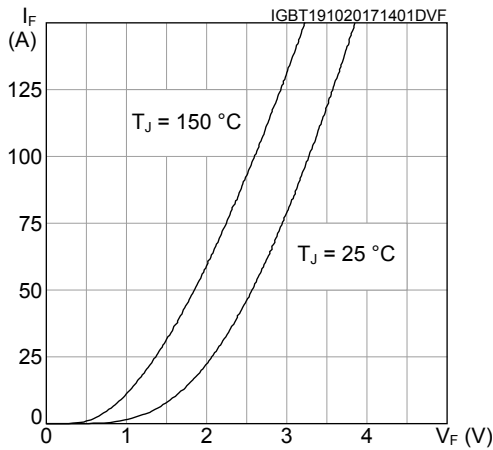

Figure 10. Diode reverse recovery energy vs diode current slope

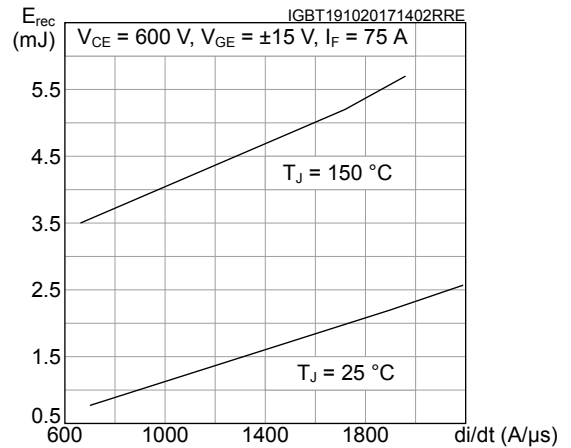

Figure 11. Diode reverse recovery energy vs forward current

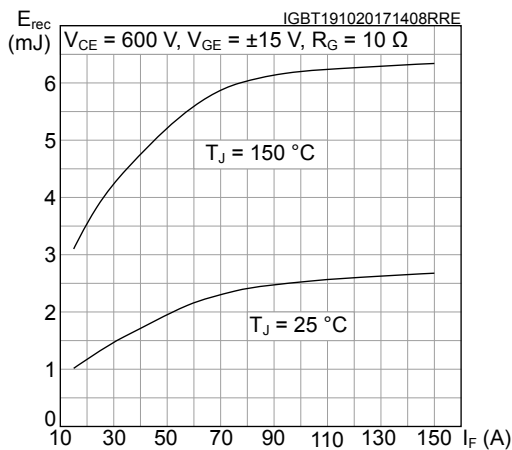

Figure 12. Diode reverse recovery energy vs gate resistance

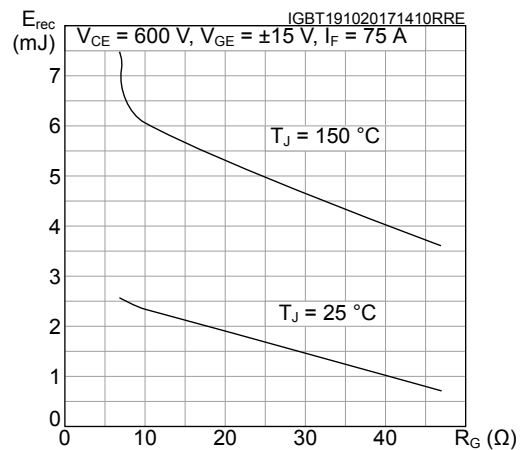

Figure 13. IGBT thermal impedance

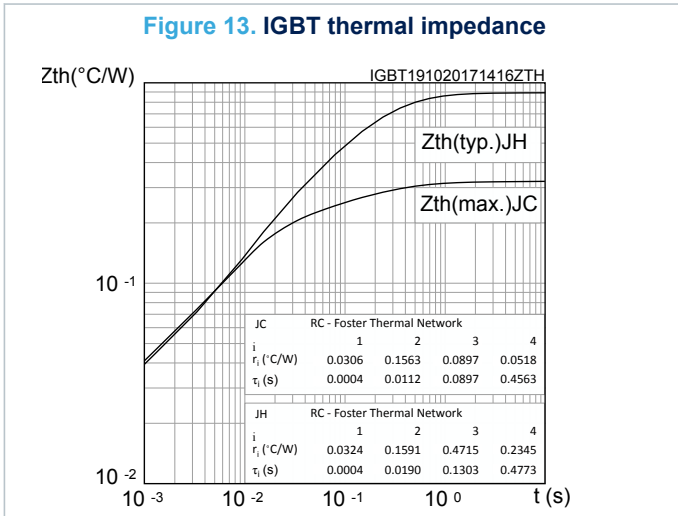
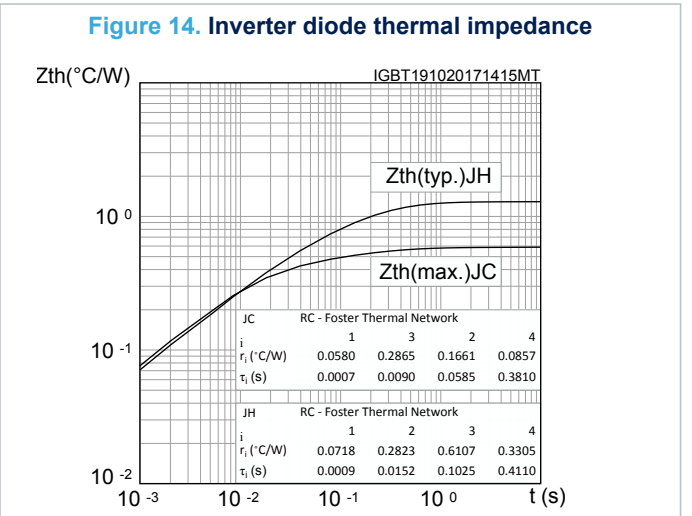
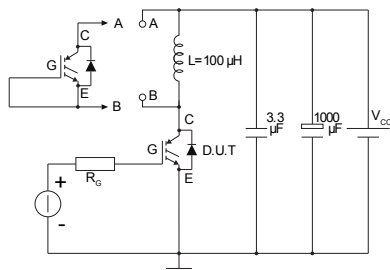

Figure 14. Inverter diode thermal impedance



3 Test circuits

Figure 15. Test circuit for inductive load switching

AM01504v1

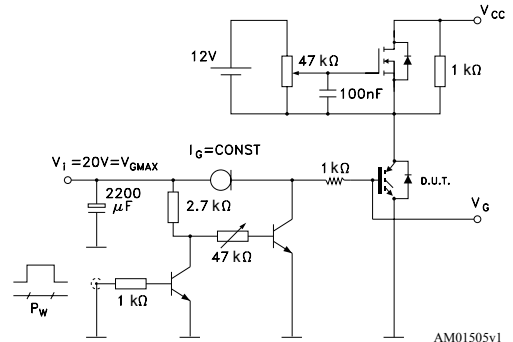
Figure 16. Gate charge test circuit

AM01505v1

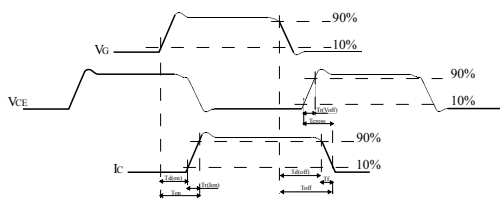
Figure 17. Switching waveform

AM01506v1

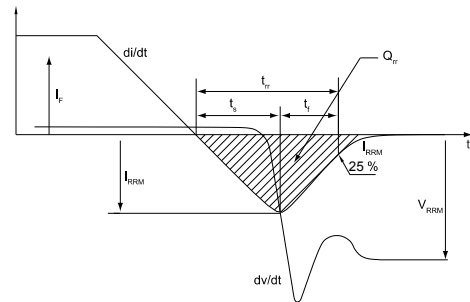
Figure 18. Diode reverse recovery waveform

AM01507v1

4 Topology and pin description

Figure 19. Electrical topology and pin description

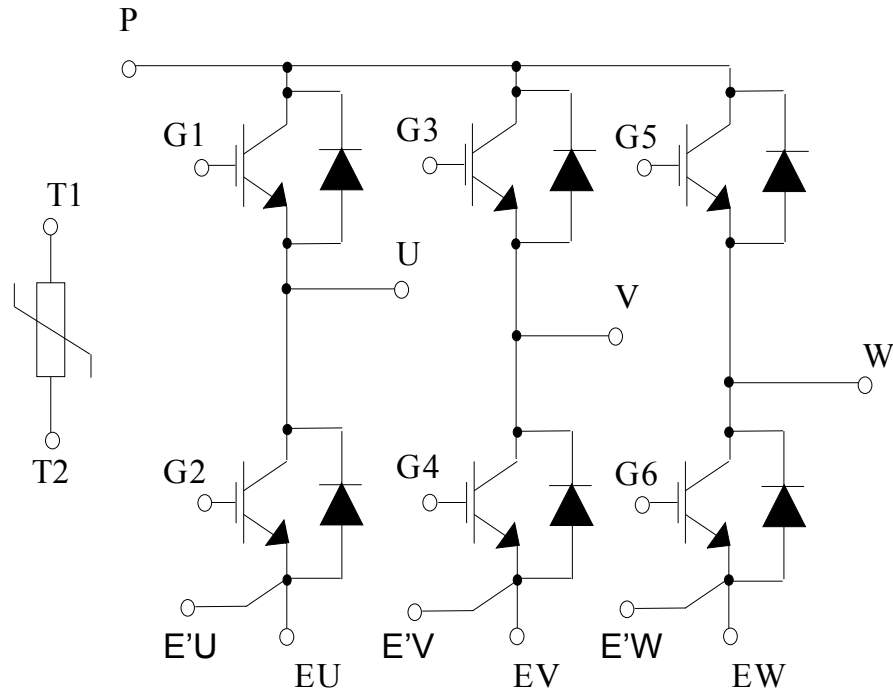
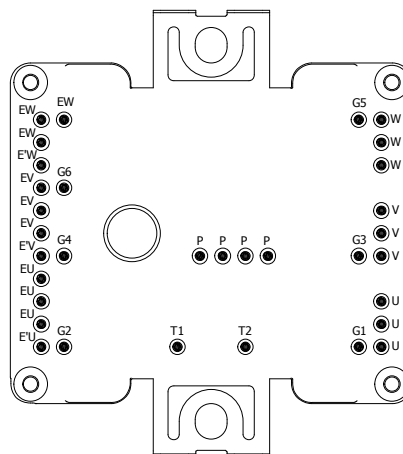

Figure 20. Package top view with sixpack pinout



5 Package information

In order to meet environmental requirements, ST offers these devices in different grades of ECOPACK® packages, depending on their level of environmental compliance. ECOPACK® specifications, grade definitions and product status are available at: www.st.com. ECOPACK® is an ST trademark.

5.1 ACEPACK™ 2 sixpack press fit contact pins package information

Figure 21. ACEPACK™ 2 sixpack press fit contact pins package outline (dimensions are in mm)

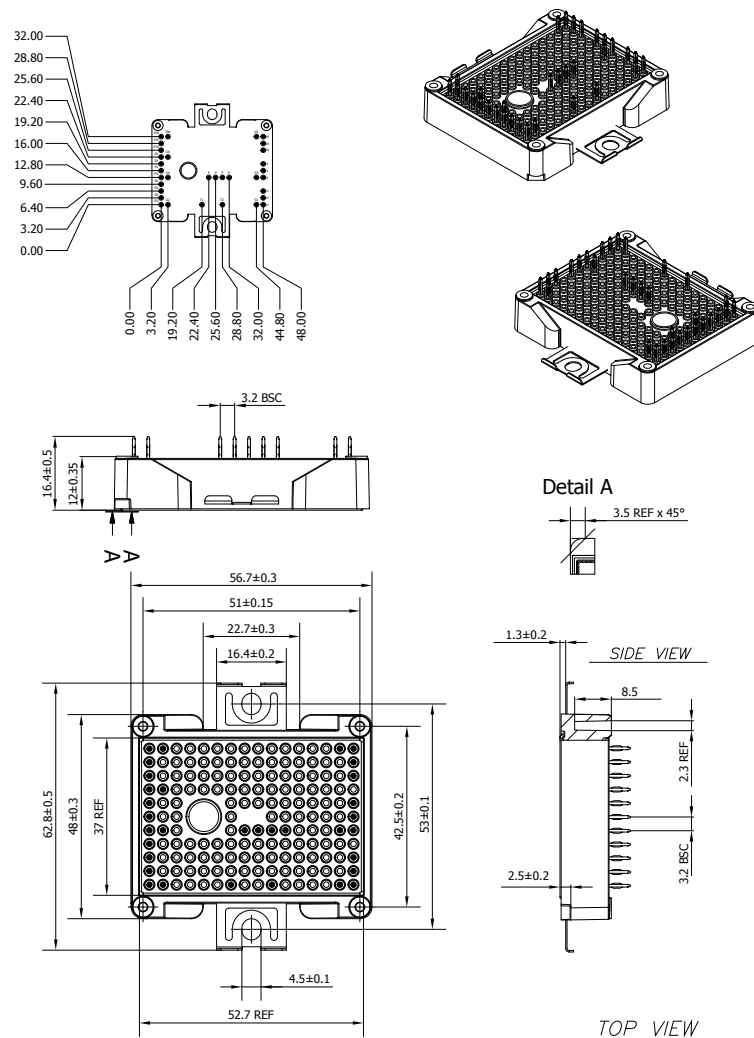

8569722 rev.4

- The lead size includes the thickness of the lead plating material.
- Dimensions do not include mold protrusion.
- Package dimensions do not include any eventual metal burrs.

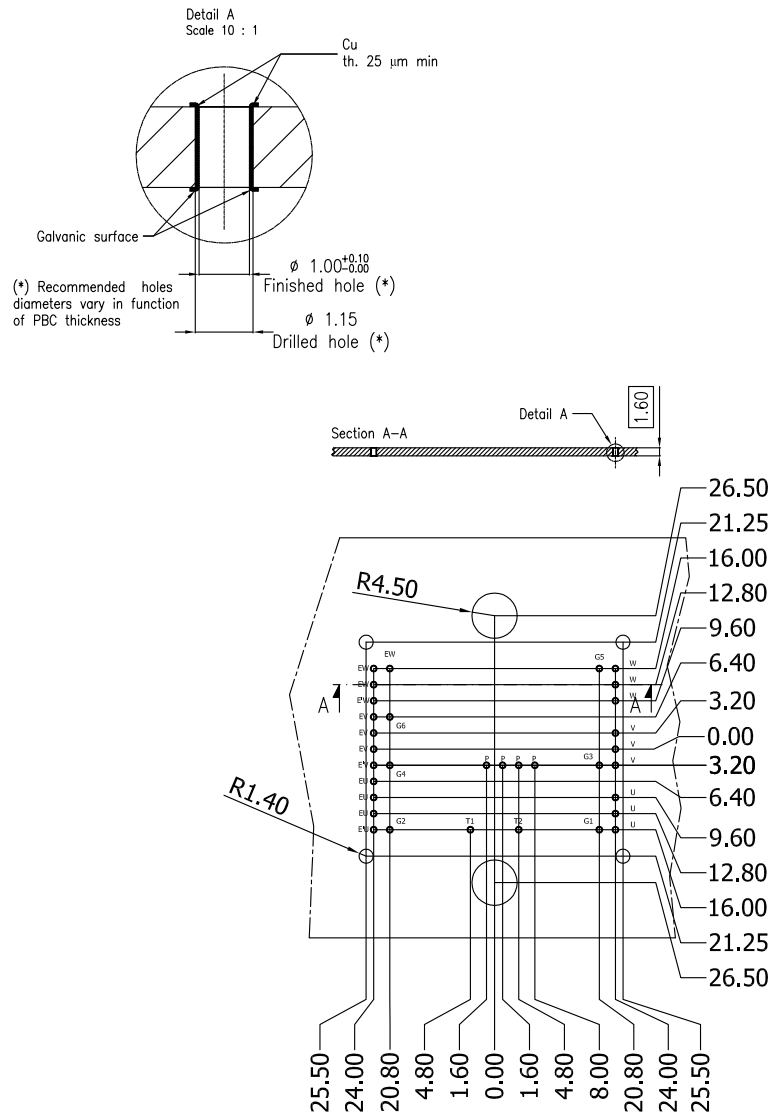
Figure 22. ACEPACK™ 2 sixpack press fit contact pins recommended PCB holes layout (dimension are in mm)

8569722 rev.4

Revision history

Table 7. Document revision history

Date	Revision	Changes
19-May-2016	1	Initial release.
24-May-2016	2	Updated <i>Table 5: "Electrical characteristics of the diode"</i> .
24-Oct-2017	3	Updated <i>Section 1: "Electrical ratings"</i> , <i>Section 2: "Electrical characteristics curves"</i> and <i>Section 5: "Package information"</i> . Minor text changes.
20-Mar-2018	4	Removed maturity status indication from cover page. The document status is production data. Updated features in cover page, Section 1.1 IGBT , Section 1.2 Diode , Section 1.4 Package , Section 2 Electrical characteristics curves and Section 5.1 ACEPACK™ 2 sixpack press fit contact pins package information . Minor text changes.

IMPORTANT NOTICE – PLEASE READ CAREFULLY

STMicroelectronics NV and its subsidiaries (“ST”) reserve the right to make changes, corrections, enhancements, modifications, and improvements to ST products and/or to this document at any time without notice. Purchasers should obtain the latest relevant information on ST products before placing orders. ST products are sold pursuant to ST’s terms and conditions of sale in place at the time of order acknowledgement.

Purchasers are solely responsible for the choice, selection, and use of ST products and ST assumes no liability for application assistance or the design of Purchasers’ products.

No license, express or implied, to any intellectual property right is granted by ST herein.

Resale of ST products with provisions different from the information set forth herein shall void any warranty granted by ST for such product.

ST and the ST logo are trademarks of ST. All other product or service names are the property of their respective owners.

Information in this document supersedes and replaces information previously supplied in any prior versions of this document.

© 2018 STMicroelectronics – All rights reserved



Компания «ЭлектроПласт» предлагает заключение долгосрочных отношений при поставках импортных электронных компонентов на взаимовыгодных условиях!

Наши преимущества:

- Оперативные поставки широкого спектра электронных компонентов отечественного и импортного производства напрямую от производителей и с крупнейших мировых складов;
- Поставка более 17-ти миллионов наименований электронных компонентов;
- Поставка сложных, дефицитных, либо снятых с производства позиций;
- Оперативные сроки поставки под заказ (от 5 рабочих дней);
- Экспресс доставка в любую точку России;
- Техническая поддержка проекта, помощь в подборе аналогов, поставка прототипов;
- Система менеджмента качества сертифицирована по Международному стандарту ISO 9001;
- Лицензия ФСБ на осуществление работ с использованием сведений, составляющих государственную тайну;
- Поставка специализированных компонентов (Xilinx, Altera, Analog Devices, Intersil, Interpoint, Microsemi, Aeroflex, Peregrine, Syfer, Eurofarad, Texas Instrument, Miteq, Cobham, E2V, MA-COM, Hittite, Mini-Circuits, General Dynamics и др.);

Помимо этого, одним из направлений компании «ЭлектроПласт» является направление «Источники питания». Мы предлагаем Вам помощь Конструкторского отдела:

- Подбор оптимального решения, техническое обоснование при выборе компонента;
- Подбор аналогов;
- Консультации по применению компонента;
- Поставка образцов и прототипов;
- Техническая поддержка проекта;
- Защита от снятия компонента с производства.



Как с нами связаться

Телефон: 8 (812) 309 58 32 (многоканальный)

Факс: 8 (812) 320-02-42

Электронная почта: org@eplast1.ru

Адрес: 198099, г. Санкт-Петербург, ул. Калинина, дом 2, корпус 4, литера А.