

Low Voltage Splices, 1000 V or less

For installations from 120 V to 1 kV, 3M offers several low voltage splice options, including 3M-developed cold shrink technology, heat shrink, resin and tape. 3M™ Low Voltage Splices are reliable in buried, overhead, indoor or outdoor applications.



Section	Page
3M™ Heat Shrink Splice Kits	149-152
3M™ Splice Kit UF	149
3M™ Airport Lighting Connector Sealing Kit	149
3M™ Heat Shrink Heavy-Wall Cable Sleeves ITCSN	150-152
3M™ Direct Bury Splice Kits	152-153
3M™ Direct Bury Splice Kit DBO/B-6.....	152
3M™ Direct Bury Splice Kit DBR/Y-6	153
3M™ Resin Splice Kits	154-162
3M™ Scotchcast™ Inline Splice Kits, 72-N Series	154
3M™ Scotchcast™ Re-Enterable Signal and Control Cable Splice Kits 78-R Series.....	155
3M™ Scotchcast™ Multi-Mold Resin Splice Kits 85 Series	156
3M™ Scotchcast™ Wye Resin Splice Kit 90-B1	157
3M™ Scotchcast™ Flexible Power Cable Tap Splice Kit 82-BF1.....	157
3M™ Scotchcast™ Inline Resin Power Cable Splice Kits 82-A Series.....	158
3M™ Scotchcast™ Wye Resin Splice Kit 82-B1	158
3M™ Scotchcast™ Flexible Power Cable Inline Splicing Kits 82-F Series.....	159
3M™ Scotchcast™ Flame-Retardant Compound 2131	160
3M™ Scotchcast™ Potting Kit 2136	161
3M™ Resin Pressure System Components	162
3M™ Cold Shrink Splice Kits	163-171
3M™ Cold Shrink Connector Insulators 8420 and 8430 Series.....	163-164
3M™ Cold Shrink Silicone Insulators 8440 Series (1000 Volts or less)	165
3M™ Cold Shrink Quick Insulator QI Series	166
3M™ Cold Shrink Quick Splice Low Voltage QSLV-M Series.....	167
3M™ Cold Shrink Connector Insulator WF Series.....	168
3M™ Inline Splices for 3/C or 4/C Armored Power Cable (Teck-90) 5730 Series	169
3M™ Resin/Cold Shrink Non-Shielded, Armored or Non-Armored Splice Kits 5750 Series	170
3M™ Cold Shrink Portable Cable Splice Kits 2237A and 2238A.....	171

Cable Types for Low Voltage Splicing



Single Conductor Cable



Multiple Conductor Unshielded Signal and Control Cable



Multiple Conductor Shielded Signal and Control Cable



Multiple Conductor, to 1000 Volt, Cable



Three-Conductor Armored, Non Shielded Cable





Three-Conductor Non-Armored, Non Shielded Cable

3M™ Heat Shrink Splice Kits

3M™ Splice Kit UF

3M™ Splice Kit UF is designed to provide a reliable, moisture proof electrical connection for type UF-B underground feeder cable rated for 600 V (copper wire only) ranging from #14/3 without ground wire up to #8/3 with ground wire.

The UF splice kit consists of a connector-insulation assembly and a heat shrink tube. The connector assembly contains four cylindrical set screw connectors separated by a piece of vinyl insulation. The heat shrink tube is a heavy-wall, adhesive-lined tube. Underground Feeder (UF)-B cables are flat, and typically have three solid conductors without a ground or two solid conductors with a ground. They range in size from 14–8 AWG. The most common UF cable size is 14–10 AWG.

Voltage Rating	600 V (copper wire only)
Number of Conductors	Single Conductor
Cable/Shielding Type	Non-Shielded
Splice Type	Heat Shrink
Operating Temperature Range	-67°F to 230°F (-55°C to 110°C)
RoHS 2011/65/EU	Yes
Agency Approvals	 UL 486D listed E102356
Manufacturing Origin	



Order No.	UPC	Description	Conductor Size	Min. Order Qty.	Case Qty.
UF1-Splice Kit-6 Kits	054007-42920	UF Splice Kit-Standard includes 1.8" (45,7 mm) length connector/ 8.0" (203,2 mm) length of heavy wall, adhesive lined heat shrink tube.	14–8 AWG	6 kits	6 kits
UF2-Splice Kit-6 Kits	054007-42921	UF Splice Kit-Stretcher offers an 11.5" (292,1 mm) length connector/ 20.0" (508,0 mm) length of heavy wall, adhesive lined heat shrink tube. The Stretcher Kit is used in situations where a 7–10" (17,8–25,4 cm) section of the cable has been damaged or destroyed.	14–8 AWG	6 kits	6 kits

3M™ Airport Lighting Connector Sealing Kit



3M™ Airport Lighting Connector Sealing Kit IAL-3 is designed especially to meet the high demands on airport lighting connections. It meets specification for sealing FAA Specification L-823 connectors.

Kit Includes:

- ◆ Heat shrinkable sleeve
- ◆ Cleaning pad
- ◆ Instructions



RoHS 2011/65/EU Yes

Order No.	UPC	Sleeve Length	Expanded/Recovered I.D.	Case Qty.
IAL-3	054007-08862	16" (406,4 mm)	1.38/0.38" (35,1/9,7 mm)	30 kit/case

3M™ Heat Shrink Splice Kits

3M™ Heat Shrink Heavy-Wall Cable Sleeves ITCSN

The 3M™ Heat Shrink Heavy-Wall Cable Sleeves ITCSN are designed to provide reliable performance for electrical splices, connections and terminations, as well as mechanical and environmental protection. ITCSN heavy-wall cable sleeves are cross-linked polyolefin. They are highly split resistant and fast shrinking to provide rapid installation. The cut-to-length sleeves come standard with a factory-applied adhesive/sealant. Order any of several packaging choices or look for the counter merchandiser assortment at a 3M authorized distributor.

Voltage Rating	UL Rated to 600 V 3M Internal Test Rated to 1 kV
Material	Polyolefin
Shrink Ratio	3:1
Operating Temperature	-67°F to 230°F (-55°C to 110°C)
Flame Retardant	No
RoHS 2011/65/EU	Yes
Agency Approvals	
Manufacturing Origin	



Order No.	UPC	Cable Size	Length	Expanded/Recovered I.D.	UL Spec.	Adhesive Included	Direct Bury	Case Qty.
ITCSN-0400-6"-Black-25 Pcs	054007-08887	12-6 AWG	6" (152,4 mm)	0.40"/0.15" (10,2/3,8 mm)	UL 486D	Yes	Yes	25
ITCSN-0400-6"-Black-100 Pcs	054007-08963	12-6 AWG	6" (152,4 mm)	0.40"/0.15" (10,2/3,8 mm)	UL 486D	Yes	Yes	100
ITCSN-0400-6"-Black-12-3 Pc Pks	051128-60075	12-6 AWG	6" (152,4 mm)	0.40"/0.15" (10,2/3,8 mm)	UL 486D	Yes	Yes	3/pk, 12 pks
ITCSN-0400-6"-Red-12-3 Pc Pks	051128-60076	12-6 AWG	6" (152,4 mm)	0.40"/0.15" (10,2/3,8 mm)	N/A	Yes	No	3/pk, 12 pks
ITCSN-0400-48"-Black-5 Pcs	054007-08902	12-6 AWG	48" (1,22 m)	0.40"/0.15" (10,2/3,8 mm)	UL 486D	Yes	Yes	5
ITCSN-0400-48"-Black-20 Pcs	054007-08964	12-6 AWG	48" (1,22 m)	0.40"/0.15" (10,2/3,8 mm)	UL 486D	Yes	Yes	20
ITCSN-0400-25'-Black-Reel	054007-08886	12-6 AWG	25' (7,62 m)	0.40"/0.15" (10,2/3,8 mm)	N/A	No	No	1
ITCSN-0800-6"-Black-25 Pcs	054007-40067	8-1/0 AWG	6" (152,4 mm)	0.80"/0.20" (20,3/5,1 mm)	UL 486D	Yes	Yes	25
ITCSN-0800-6"-Black-100 Pcs	054007-08965	8-1/0 AWG	6" (152,4 mm)	0.80"/0.20" (20,3/5,1 mm)	UL 486D	Yes	Yes	100
ITCSN-0800-6"-Black-12-3 Pc Pks	051128-60077	8-1/0 AWG	6" (152,4 mm)	0.80"/0.20" (20,3/5,1 mm)	UL 486D	Yes	Yes	3/pk, 12 pks
ITCSN-0800-6"-Red-12-3 Pc Pks	051128-60078	8-1/0 AWG	6" (152,4 mm)	0.80"/0.20" (20,3/5,1 mm)	N/A	Yes	No	3/pk, 12 pks
ITCSN-0800-9"-Black-25 Pcs	054007-08890	8-1/0 AWG	9" (228,6 mm)	0.80"/0.20" (20,3/5,1 mm)	UL 486D	Yes	Yes	25
ITCSN-0800-9"-Black-100 Pcs	054007-08966	8-1/0 AWG	9" (288,6 mm)	0.80"/0.20" (20,3/5,1 mm)	UL 486D	Yes	Yes	100 pcs/cs
ITCSN-0800-12"-Black-25 Pcs	054007-08889	8-1/0 AWG	12" (304,8 mm)	0.80"/0.20" (20,3/5,1 mm)	UL 486D	Yes	Yes	25 pcs/cs
ITCSN-0800-12"-Black-100 Pcs	054007-08967	8-1/0 AWG	12" (304,8 mm)	0.80"/0.20" (20,3/5,1 mm)	UL 486D	Yes	Yes	100
ITCSN-0800-48"-Black-5 Pcs	054007-08903	8-1/0 AWG	48" (1,22 m)	0.80"/0.20" (20,3/5,1 mm)	UL 486D	Yes	Yes	5
ITCSN-0800-48"-Black-20 Pcs	054007-08968	8-1/0 AWG	48" (1,22 m)	0.80"/0.20" (20,3/5,1 mm)	UL 486D	Yes	Yes	20

3M™ Heat Shrink Splice Kits

3M™ Heat Shrink Heavy-Wall Cable Sleeves ITCSN (continued)

Order No.	UPC	Cable Size	Length	Expanded/Recovered I.D.	UL Spec.	Adhesive Included	Direct Bury	Case Qty.
ITCSN-0800-48"-Red-20 Pcs	051128-55500	8-1/0 AWG	48" (1,22 m)	0.80"/0.20" (20,3/5,1 mm)	N/A	Yes	No	20
ITCSN-0800-25'-Black-Reel	054007-08888	8-1/0 AWG	25' (7,62 m)	0.80"/0.20" (20,3/5,1 mm)	N/A	No	No	1
ITCSN-1100-6"-Black-25 Pcs	054007-08894	2-4/0 AWG	6" (152,4 mm)	1.10"/0.37" (27,9/9,4 mm)	UL 486D	Yes	Yes	25
ITCSN-1100-6"-Black-100 Pcs	054007-08969	2-4/0 AWG	6" (152,4 mm)	1.10"/0.37" (27,9/9,4 mm)	UL 486D	Yes	Yes	100
ITCSN-1100-9"-Black-25 Pcs	054007-08893	2-4/0 AWG	9" (228,6 mm)	1.10"/0.37" (27,9/9,4 mm)	UL 486D	Yes	Yes	25
ITCSN-1100-9"-Black-100 Pcs	054007-08970	2-4/0 AWG	9" (228,6 mm)	1.10"/0.37" (27,9/9,4 mm)	UL 486D	Yes	Yes	100
ITCSN-1100-9"-Black-12-3 Pc Pks	051128-60079	2-4/0 AWG	9" (228,6 mm)	1.10"/0.37" (27,9/9,4 mm)	UL 486D	Yes	Yes	3/pk, 12 pks
ITCSN-1100-9"-Red-12-3 Pc Pks	051128-60080	2-4/0 AWG	9" (228,6 mm)	1.10"/0.37" (27,9/9,4 mm)	N/A	Yes	No	3/pk, 12 pks
ITCSN-1100-12"-Black-10 Pcs	054007-08892	2-4/0 AWG	12" (304,8 mm)	1.10"/0.37" (27,9/9,4 mm)	UL 486D	Yes	Yes	10
ITCSN-1100-12"-Black-100 Pcs	054007-08971	2-4/0 AWG	12" (304,8 mm)	1.10"/0.37" (27,9/9,4 mm)	UL 486D	Yes	Yes	100
ITCSN-1100-48"-Black-5 Pcs	054007-08904	2-4/0 AWG	48" (1,22 m)	1.10"/0.37" (27,9/9,4 mm)	UL 486D	Yes	Yes	5
ITCSN-1100-48"-Black-20 Pcs	054007-08972	2-4/0 AWG	48" (1,22 m)	1.10"/0.37" (27,9/9,4 mm)	UL 486D	Yes	Yes	20
ITCSN-1100-25'-Black-Reel	054007-08891	2-4/0 AWG	25' (7,62 m)	1.10"/0.37" (27,9/9,4 mm)	N/A	No	No	1
ITCSN-1500-9"-Black-10 Pcs	054007-08897	3/0 AWG- 400 kcmil	9" (228,6 mm)	1.50"/0.50" (38,1/12,7 mm)	UL 486D	Yes	Yes	10
ITCSN-1500-9"-Black-50 Pcs	054007-08973	3/0 AWG- 400 kcmil	9" (228,6 mm)	1.50"/0.50" (38,1/12,7 mm)	UL 486D	Yes	Yes	50
ITCSN-1500-9"-Black-12-3 Pc Pks	051128-60081	3/0 AWG- 450 kcmil	9" (228,6 mm)	1.50"/0.50" (38,1/12,7 mm)	UL 486D	Yes	Yes	3/pk, 12 pks
ITCSN-1500-12"-Black-10 Pcs	054007-08896	3/0 AWG- 400 kcmil	12" (304,8 mm)	1.50"/0.50" (38,1/12,7 mm)	UL 486D	Yes	Yes	10
ITCSN-1500-12"-Black-50 Pcs	054007-08974	3/0 AWG- 400 kcmil	12" (304,8 mm)	1.50"/0.50" (38,1/12,7 mm)	UL 486D	Yes	Yes	50
ITCSN-1500-48"-Black-5 Pcs	054007-08905	3/0 AWG- 400 kcmil	48" (1,22 m)	1.50"/0.50" (38,1/12,7 mm)	UL 486D	Yes	Yes	5
ITCSN-1500-48"-Black-20 Pcs	054007-08975	3/0 AWG- 400 kcmil	48" (1,22 m)	1.50"/0.50" (38,1/12,7 mm)	UL 486D	Yes	Yes	20
ITCSN-1500-25'-Black-Reel	054007-08895	3/0 AWG- 450 kcmil	25' (7,62 m)	1.50"/0.50" (38,1/12,7 mm)	N/A	No	No	1
ITCSN-2000-9"-Black-10 Pcs	054007-08900	250-750 kcmil	9" (228,6 mm)	2.00"/0.65" (50,8/16,5 mm)	UL 486D	Yes	Yes	10
ITCSN-2000-9"-Black-50 Pcs	054007-08976	250-750 kcmil	9" (228,6 mm)	2.00"/0.65" (50,8/16,5 mm)	UL 486D	Yes	Yes	50
ITCSN-2000-12"-Black-10 Pcs	054007-08899	250-750 kcmil	12" (304,8 mm)	2.00"/0.65" (50,8/16,5 mm)	UL 486D	Yes	Yes	10
ITCSN-2000-12"-Black-50 Pcs	054007-08977	250-750 kcmil	12" (304,8 mm)	2.00"/0.65" (50,8/16,5 mm)	UL 486D	Yes	Yes	50
ITCSN-2000-12"-Black-12-3 Pc Pks	051128-60082	250-750 kcmil	12" (304,8 mm)	2.00"/0.65" (50,8/16,5 mm)	UL 486D	Yes	Yes	3/pk, 12 pks
ITCSN-2000-48"-Black-5 Pcs	054007-08906	250-750 kcmil	48" (1,22 m)	2.00"/0.65" (50,8/16,5 mm)	UL 486D	Yes	Yes	5
ITCSN-2000-48"-Black-20 Pcs	054007-08978	250-750 kcmil	48" (1,22 m)	2.00"/0.65" (50,8/16,5 mm)	UL 486D	Yes	Yes	20

Low Voltage Splices, 1000 V or less

3M™ Heat Shrink Splice Kits

3M™ Heat Shrink Heavy-Wall Cable Sleeves ITCSN (continued)

Order No.	UPC	Cable Size	Length	Expanded/Recovered I.D.	UL Spec.	Adhesive Included	Direct Bury	Case Qty.
ITCSN-2000-25'-Black-Reel	054007-08898	250-750 kcmil	25' (7,62 m)	2.00"/0.65" (50,8/16,5 mm)	N/A	No	No	1
ITCSN-3000-12"-Black-10 Pcs	054007-08901	600-1250 kcmil	12" (304,8 mm)	3.00"/1.00" (76,2/25,4 mm)	N/A	Yes	No	10
ITCSN-3000-12"-Black-50 Pcs	054007-08979	600-1250 kcmil	12" (304,8 mm)	3.00"/1.00" (76,2/25,4 mm)	N/A	Yes	No	50
ITCSN-3000-48"-Black-5 Pcs	054007-08907	600-1250 kcmil	48" (1,22 m)	3.00"/1.00" (76,2/25,4 mm)	N/A	Yes	No	5
ITCSN-3000-48"-Black-20 Pcs	054007-08980	600-1250 kcmil	48" (1,22 m)	3.00"/1.00" (76,2/25,4 mm)	N/A	Yes	No	20
ITCSN-4500-48"-Black-5 Pcs	051135-37979	1500-2500 kcmil	48" (1,22 m)	4.50"/1.50" (114,3/38,1 mm)	N/A	Yes	No	5
ITCSN-4500-48"-Black-20 Pcs	054007-08981	1500-2500 kcmil	48" (1,22 m)	4.50"/1.50" (114,3/38,1 mm)	N/A	Yes	No	20
ITCSN-6000-48"-Black-5 Pcs	051135-37980	2.1"-4.8"	48" (1,22 m)	6.00"/1.80" (152,4/45,7 mm)	N/A	Yes	No	5
ITCSN-6000-48"-Black-20 Pcs	054007-08982	2.1"-4.8"	48" (1,22 m)	6.00"/1.80" (152,4/45,7 mm)	N/A	Yes	No	20

3M™ Direct Bury Splice Kits

3M™ Direct Bury Splice Kit DB0/B-6

The 3M™ Direct Bury Splice Kit DB0/B-6 is used to electrically connect two or more pre-stripped copper wires and moisture seal the connection for direct burial. The kit includes a 3M™ Performance Plus Wire Connector O/B+ and a high impact, UV-resistant polypropylene tube prefilled with moisture-resistant grease.

Voltage	600 V
Splice Type	Direct Bury
Application Temperature Range	32–120°F (0–49°C)
Operating Temperature	221°F (105°C)
Flame Retardant	Yes
RoHS 2011/65/EU	Yes
Agency Approval	

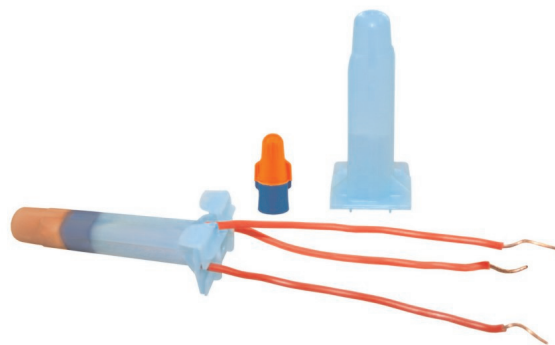

Order No.	UPC	Conductor Size	Common AWG Wire Combinations (CU only)	Case Qty.
DB0/B-6 KIT	051128-59075	18–10 AWG	2–3#16 sol/str; 2–3#14 sol/str; 2#12 sol/str; 1#14 to 1#12 sol/str; 1#18 to 1–2#14 sol/str; 1#18 to 1–2#12 sol/str; 1#16 to 1–2#14 sol/str; 1#16 to 1–2#12 sol/str	25 Kits
DB0/B-6 BULK	051128-59076	18–10 AWG	2–3#16 sol/str; 2–3#14 sol/str; 2#12 sol/str; 1#14 to 1#12 sol/str; 1#18 to 1–2#14 sol/str; 1#18 to 1–2#12 sol/str; 1#16 to 1–2#14 sol/str; 1#16 to 1–2#12 sol/str	100 Kits

3M™ Direct Bury Splice Kits

3M™ Direct Bury Splice Kit DBR/Y-6

The 3M™ Direct Bury Splice Kit DBR/Y-6 is used to electrically connect two or more pre-stripped copper wires and moisture seal the connection for direct burial. The kit includes a 3M™ Performance Plus Wire Connector R/Y+ and a high impact, UV-resistant polypropylene tube pre-filled with moisture-resistant grease.

Voltage	600 V
Splice Type	Direct Bury
Application Temperature Range	32–120°F (0–49°C)
Operating Temperature Range	-40–221°F (-40–105°C)
Flame Retardant	Yes
RoHS 2011/65/EU	Yes
Agency Approval	



Order No.	UPC	Conductor Size	Common AWG Wire Combinations (CU only)	Case Qty.
DBR/Y-6 KIT	051128-58573	18–10 AWG	2–7#18; 2–6#16; 2–4#14; 2–4#12; 2–3#10; 1–3#12 w/ 1#18; 1–2#10 w/1#18; 1–2#10 w/1#12; 1–2#14 w/ 1#18	25 Kits
DBR/Y-6 BULK	051128-58574	18–10 AWG	2–7#18; 2–6#16; 2–4#14; 2–4#12; 2–3#10; 1–3#12 w/ 1#18; 1–2#10 w/1#18; 1–2#10 w/1#12; 1–2#14 w/ 1#18	100 Kits

3M™ Resin Splice Kits

3M™ Scotchcast™ Inline Splice Kits, 72-N Series

The 3M™ Scotchcast™ Inline Splicing Kits 72-N Series is a series of rigid body splices tailored for joining signal and control cables rated up to 1000 V. The kits are designed to accommodate shielded or unshielded constructions of plastic or rubber-jacketed cables. Six kit sizes cover a range of cables up to 100-pair (200 conductors) 10 AWG or 200-pair (400 conductors) 22 AWG.

Connectors are not included, order separately. Each kit contains sufficient material to make one splice, excluding connectors.

3M Scotchcast 72-N Series Selection (Based on Conductor/Connector Bundle)

Kit No.	Scotchlok™ Insulated Butt Connectors											
	MV18BC 22-18 AWG				MV14BC 16-14 AWG				MV10BC 12-10 AWG			
	Shielded Cables**		Unshielded Cables**		Shielded Cables**		Unshielded Cables**		Shielded Cables**		Unshielded Cables**	
No Cond.	No Pairs	No Cond.	No Pairs	No Cond.	No Pairs	No Cond.	No Pairs	No Cond.	No Pairs	No Cond.	No Pairs	
72-N1*	—	—	6	3	—	—	4	2	—	—	3	—
72-N2	18	9	32	16	12	6	19	9	8	4	13	6
72-N3	42	21	75	37	24	12	45	22	14	7	27	13
72-N4	74	37	160	80	50	25	90	45	40	20	60	30
72-N5	140	70	200	100	120	60	160	80	100	50	100	50
72-N6	360	180	400	200	220	110	250	125	180	90	200	100

*Nonshielded cable only.

**Figures based on IMSA cable specifications.

Voltage	1000 V or less
Number of Conductors	Multiple Conductors
Cable/Shielding Type	Shielded and Non-Shielded Signal and Control Cable
Splice Type	Resin
Applications	To splice signal and control cables rated up to 1000 V. Inline splicing of shielded and non-shielded cables in direct burial applications.
RoHS 2011/65/EU	Yes



Multiple Conductor Nonshielded Signal & Control Cable



Multiple Conductor Shielded Signal & Control Cable



Order No.	UPC	Shielded/Non-Shielded	Molded Body Length	Cable O.D.	Case Qty.
72-N1	054007-10623	Non-Shielded	7.125" (181,0 mm)	0.250"-0.625" (6,4-15,9 mm)	10
72-N2	054007-10625	Shielded	10.562" (268,3 mm)	0.500"-1.000" (12,7-25,4 mm)	10
72-N3	054007-10627	Shielded	15.438" (392,1 mm)	0.625"-1.500" (15,9-38,1 mm)	10
72-N4	054007-10629	Shielded	15.625" (396,9 mm)	1.000"-2.000" (25,4-50,8 mm)	1
72-N5	054007-10631	Shielded	20.312" (515,9 mm)	1.250"-2.250" (31,8-57,2 mm)	1
72-N6	054007-10633	Shielded	25" (635,0 mm)	1.250"-3.250" (31,8-82,6 mm)	1

3M™ Resin Splice Kits

3M™ Scotchcast™ Re-Enterable Signal and Control Cable Splice Kits 78-R Series

3M™ Scotchcast™ Re-Enterable Signal and Control Cable Splice Kits 78-R Series make inline or tap splices on shielded or nonshielded, plastic- and rubber-jacketed, signal and control (or power) cable rated up to 1 kV.

Connectors are not included, order separately. Each kit contains sufficient material to make one splice.

3M™ Scotchcast™ 78-R Series Connector Selection

Kit No.	Scotchlok™ Connectors																	
	Insulated Butt Connectors						Pigtail Connectors						Tap Connectors					
	MV18BC 22-18 AWG		MV14BC 16-14 AWG		MV10BC 12-10 AWG		"Y" 18-12 AWG		"R" 14-10 AWG		557 22-18 AWG		558 22-18 AWG		560 18-14 AWG		562 12-10 AWG	
No Cond.	No Pairs	No Cond.	No Pairs	No Cond.	No Pairs	No Cond.	No Pairs	No Cond.	No Pairs	No Cond.	No Pairs	No Cond.	No Pairs	No Cond.	No Pairs	No Cond.	No Pairs	
78-R1	40	20	26	13	16	8	8	4	5	2	15	7	10	5	8	4	6	3
78-R2	66	33	45	22	26	13	20	10	10	5	30	15	20	10	16	8	12	6
78-R3	160	80	110	55	70	35	50	25	28	14	80	40	50	25	40	20	36	18
78-R4	300	150	180	90	110	55	84	42	60	30	142	71	100	50	80	40	68	34
78-R5	550	275	320	160	200	100	174	87	120	60	260	130	200	100	160	80	130	65

Note: Above figures based on IMSA cable specifications.

Voltage	1000 V or less
Number of Conductors	Multiple Conductor
Cable/Shielding Type	Shielded and Non-Shielded Signal and Control Cable
Splice Type	Resin
RoHS 2011/65/EU	Yes
Applications	Inline wye, "x," or butt splicing of shielded or non-shielded cable in direct bury applications.



Multiple Conductor Nonshielded Signal & Control Cable

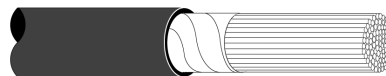

Multiple Conductor Shielded Signal & Control Cable



Order No.	UPC	Kit Size, L x I.D.	Cable O.D., Run	Cable O.D., Tap	Case Qty.
78-R1	051128-55115	12.50" x 2.75" (318 x 70 mm)	0.25"-1.00" (6,4-25,4 mm)	0.25"-1.00" (6,4-25,4 mm)	1
78-R2	051128-55116	24.50" x 2.75" (622 x 70 mm)	0.25"-1.00" (6,4-25,4 mm)	0.25"-1.00" (6,4-25,4 mm)	1
78-R3	051128-55117	24.50" x 3.81" (622 x 97 mm)	0.50"-1.50" (12,7-38,1 mm)	0.50"-1.00" (12,7-25,4 mm)	1
78-R4	051128-55118	24.50" x 4.81" (622 x 122 mm)	0.50"-2.00" (12,7-50,8 mm)	0.50"-1.75" (12,7-44,5 mm)	1
78-R5	051128-55119	26.50" x 6.00" (673 x 152 mm)	1.00"-2.50" (25,4-63,5 mm)	1.00"-2.50" (25,4-63,5 mm)	1

3M™ Resin Splice Kits



3M™ Scotchcast™ Multi-Mold Resin Splice Kits 85 Series

The 3M™ Scotchcast™ Multi-Mold Resin Splice Kit 85 Series are used to electrically insulate odd-sized and odd-shaped splices on cables rated through 1 kV. These flexible plastic molds are easily formed around splices. Within 30 minutes after the resin has been poured, the splice is ready for service – above ground or buried.

The 85-14CP splice is specifically designed for use in cathodic protection with 3M™ Scotchcast™ Electrical Insulating Resin 4.

Each kit makes one splice. Connectors are not included and must be ordered separately.

* Single Conductor Cable

Voltage	1000 V or less	 <p>Single Conductor Cable</p>	 <p>Multiple Conductor Cable</p>	
Number of Conductors	Single; Multiple			
Cable/Shielding Type	Non-shielded			
Splice Type	Resin			
Applications	Splice cables rated up to 1000 V for inline, wye, or 4-way non-shielded cable in direct bury applications.			
RoHS 2011/65/EU	Yes			

Order No.	UPC	Max. Conductor, Split Bolt	Max. Conductor, H- or C-Tap Compression	Max. Conductor, Inline Compression	Max. Connector Size (height + width)	Max. Sheath Opening	Max. Cable O.D., Wye or 4-Way	Case Qty.
85-10	054007-11846	8 AWG (stranded)	4 AWG (stranded)	-	1-3/4" (44,5 mm)	3-1/2" (88,9 mm)	Run & Tap: 7/16" (11,1 mm)	10
85-12	054007-11847	1 AWG (stranded)	2/0 AWG (stranded)	-	2-3/4" (69,9 mm)	3-1/2" (88,9 mm)	Run & Tap: 3/4" (19,1 mm)	10
85-14	054007-11848	2/0 AWG (stranded)	4/0 AWG (stranded)	-	3-1/4" (82,6 mm)	6-1/2" (165,1 mm)	Run & Tap: 7/8" (22,2 mm)	10
85-14-CP*	054007-31927	2/0 AWG (stranded)	4/0 AWG (stranded)	-	3-1/4" (82,6 mm)	9" (228,6 mm)	Run & Tap: 7/8" (22,2 mm)	10
85-16	054007-02403	250 kcmil (run) 2/0 AWG (tap)	500 kcmil (run) 4/0 AWG (tap)	750 kcmil	Split Bolt: 3-3/4" (95,3 mm) H- or C-Tap Compression: 6" (152,4 mm)	9" (228,6 mm)	Run & Tap: 7/8" (22,2 mm) Inline: 1-1/2" (38,1 mm)	10

3M™ Resin Splice Kits

3M™ Scotchcast™ Wye Resin Splice Kit 90-B1

3M™ Scotchcast™ Wye Resin Splice Kit 90-B1 insulates and moisture-seals wye splices made with the split-bolt type connectors on cables rated through 1 kV.

Each kit makes one splice. Connectors must be ordered separately.

Voltage	1000 V or less
Number of Conductors	Single; Multiple
Cable/Shielding Type	Single Conductor Cable, Multiple Conductor Cable
Splice Type	Resin
Applications	Insulation and protection of wye splices made with split bolt connectors on cable rated to 1000 V.
RoHS 2011/65/EU	Yes

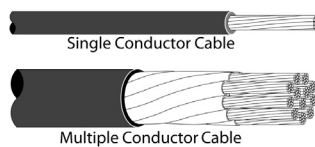

Order No.	UPC	Cable O.D. – Run	Cable O.D. (Max.) – Tap	Connector Size (Max.) – Split Bolt	Connector Size (Max.) – Crimped	Case Qty.
90-B1	054007-25115	0.50"-0.812" (12,7-20,1 mm)	0.375" (9,5 mm)	1/0 AWG	2/0 AWG	10

3M™ Scotchcast™ Flexible Power Cable Tap Splice Kit 82-BF1

3M™ Scotchcast™ Splice Kit 82-BF1 is for tap splices on non-shielded portable power cables and cords with copper conductors rated up to 1 kV. It can be used on single- conductor or multiple-conductor cables using a compression (crimp) "C" tap connector.

The 82-BF1 molds are removable and reusable. The 82-BF1 splice kit creates a permanent splice as recognized by the Mine Safety and Health Administration (07-KA060002-MSHA).

Each kit makes one splice.

* Base selection on cable O.D. range.

Voltage	1000 V or less
No. of Conductors	Multiple (600 V), Single (1000 V)
Cable/Shielding Type	Non-Shielded Portable Power Cables and Cords
Splice Type	Resin
Applications	Making tap splices on non-shielded portable power cables and cords rated to 1000 V.
RoHS 2011/65/EU	Yes
Agency Approval	MSHA

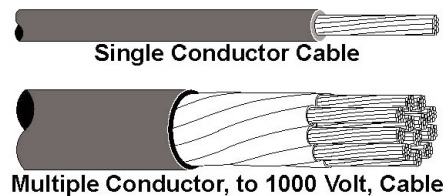

Order No.	UPC	Cable O.D.	Voltage	Conductor Size	Case Qty.
82-BF1	051128-59175	For Single: 0.25"-0.80" (6-20 mm) For Multiple: 0.25"-0.80" (6-20 mm)	For Single: 1 kV For Multiple: 600 V	For Single: 1/0 AWG (50 mm ²) For Multiple: *	10



3M™ Resin Splice Kits

3M™ Scotchcast™ Inline Resin Power Cable Splice Kits 82-A Series

Use the 3M™ Scotchcast™ Inline Resin Splice Kits 82-A Series to insulate and seal single conductor, unshielded cable splices through 5 kV and multiple conductor cables through 1 kV. Designed for use in weather-exposed or direct-burial locations. UL listed for direct burial and submerged applications up to 600 V and 90°C. For use with UL listed connectors only.

Important: Use insulation jacket or connector O.D. for final ordering criteria.

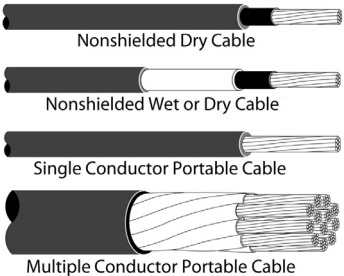
*Conductor size is 3/0 AWG–500 kcmil when using a 3M™ Scotchlok™ Copper Compression Connector 10014.



Voltage	600 V or less (Direct Bury and Submerged Applications); 1000 V (Multiple); 5 kV (Single)		
Number of Conductors	Single and Multiple		
Cable/Shielding Type	Multiple Conductor Portable Cable, Non-Shielded, Single Conductor Portable Cable		
Splice Type	Resin		
RoHS 2011/65/EU	Yes		
Agency Approvals	 Certified for 600 V or less		

Order No.	UPC	Conductor Size	Max. Connector O.D.	Max. Cable O.D.	Max. Sheath Opening (L)	Case Qty.
82-A	054007-25016	10-2 AWG	0.406" (10,3 mm)	0.75" (19,1 mm)	4.5" (114,3 mm)	10
82-A1	054007-25024	18-2 AWG	0.406" (10,3 mm)	0.625" (15,9 mm)	4.5" (114,3 mm)	10
82-A2	054007-25032	2-3/0 AWG	0.625" (15,9 mm)	1.00" (25,4 mm)	6.0" (152,4 mm)	10
82-A3	054007-25040	3/0 AWG-400 kcmil*	1.00" (25,4 mm)	1.56" (39,7 mm)	9.0" (228,6 mm)	10

3M™ Scotchcast™ Wye Resin Splice Kit 82-B1

3M™ Scotchcast™ Wye Resin Splice Kit 82-B1 insulates and seals wye splices for compression tap connectors (e.g., C-tap or H-tap) rated for cables up to 5 kV. Use on nonshielded cables through 5 kV and on multiple conductor cables through 1 kV.

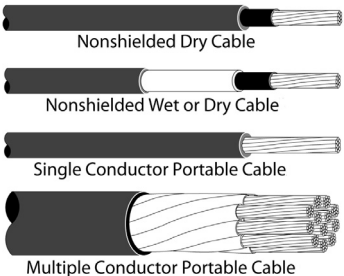
This kit will accommodate both split bolt and crimped conductors. Each kit makes one splice. Connectors are not included in the kit and must be purchased separately.

Voltage	1000 V; 5 kV		
Number of Conductors	Multiple (1000 V), Single (5 kV)		
Cable/Shielding Type	Multiple Conductor Portable Cable, Non-Shielded, Single Conductor Portable Cable		
Splice Type	Resin		
RoHS 2011/65/EU	Yes		

Order No.	UPC	Voltage Rating	Cable O.D.	Max. Conductor Size – Split Bolt	Max. Conductor Size – Crimped	Case Qty.
82-B1	054007-25057	5 kV (Single); 1 kV (Multiple)	0.25"-0.625" (6,4-16,0 mm)	4 AWG	2 AWG	10

3M™ Resin Splice Kits

3M™ Scotchcast™ Flexible Power Cable Inline Splicing Kits 82-F Series

3M™ Scotchcast™ Flexible Power Cable Inline Splicing Kits 82-F Series are a series of flexible inline splices for use on non-shielded portable power cables and cords. They are designed to be used on single and multiple conductor cables and cords rated up to 1000 Volts (600/2000 Volts mine portable cable rating). The 82-F Series accommodates a 1/C cable rated up to 5 kV. The splices accommodate 1/C cables sized up to 4/0 for inline splicing. Multi-conductor sizing is based on a cable diameter range of up to 1.2" for inline splicing.

The splice kits are based on 3M™ Scotchcast™ Flame Retardant Compound 2130 for toughness, flexibility, moisture sealing and flame retardancy. They are permanent splices as assigned by the Mine Safety and Health Administration (07-KA060002-MSHA). The completed splices are designed for use in weather-exposed, direct burial or submerged locations. 3M™ Scotchcast™ Inline Splice Kits for Flexible Power Cable 82-F1 are for use on unshielded, portable power cables. The kits are rated up to 5 kV for 1/C and up to 1 kV for multiple conductors.

Each kit makes one splice. Connectors are not included in the kit, and must be purchased separately.

*Mine portable cable rating of 600/2000 V

**Base selection on cable O.D. range

Voltage	1000 V; 5 kV
Number of Conductors	Multiple (1000 V), Single (5 kV)
Cable/Shielding Type	Non-Shielded Dry and Wet Cables, Single and Multiple Conductor Portable Cables
Splice Type	Resin
RoHS 2011/65/EU	Yes
Agency Approvals	MSHA

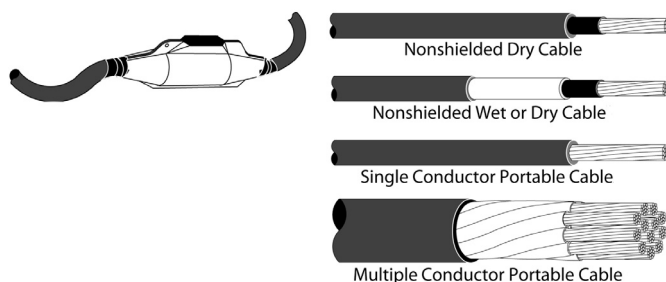

Order No.	UPC	Cable O.D.	Connection Max. O.D.	Voltage	Conductor Size	Case Qty.
82-F1	051128-59176	For Single: 0.25"-0.80" (6-20 mm) For Multiple: 0.25"-0.80" (6-20 mm)	For Single: 0.62" (16 mm) For Multiple: 0.90" (23 mm)	For Single: 5 kV For Multiple: 1 kV*	For Single: 6-1/0 AWG (16-50 mm ²) For Multiple: **	10
82-F2	051128-59177	For Single: 0.80"-1.20" (20-30 mm) For Multiple: 0.80"-1.20" (20-30 mm)	For Single: 0.82" (21 mm) For Multiple: 1.30" (33 mm)	For Single: 5 kV For Multiple: 1 kV*	For Single: 2/0-4/0 AWG (70-95 mm ²) For Multiple: **	10

3M™ Resin Splice Kits

3M™ Scotchcast™ Flame-Retardant Compound 2131

3M™ Scotchcast™ Flame-Retardant Compound 2131 is a two-part polyurethane resin designed to replace the cable jacket when splicing or repairing mine and portable cables. Its unique formulation makes it particularly suited to withstand the rugged conditions under which mine and portable cables must operate. When used in accordance with the appropriate kit configuration, Compound 2131 conforms to MSHA Part 7, Title 30 CFR.

Flame-Retardant Compound 2131 is also used as the insulating material for cable splices operating at up to 1000 volts and designed for 194°F (90°C) at continuous use and for 266°F (130°C) at temporary, overload temperature.

3M™ Scotchcast™ Flame-Retardant Compound 2131 comes in two sizes of 2-part pouch containers, as well as separate 5 gallon jugs for both Part A and Part B. (Note: 2.1 parts of B required for every 1 part of A by weight.)

Voltage	1000 Volts or less
Cure Time	16 to 24 Hours at 70°F (21°C)
Energize Time	Immediately
Max. Operating Temperature	194°F (90°C) continuous
Color	Black
RoHS 2011/65/EU	Yes
Used in these kits	5750; 5760; 5831; 5832; 82-F1; 82-F2; 82-BF1; M-20; M-30; M-40



Order No.	UPC	Packaging Description	Weight	Volume in³ (cm³)	Case Qty.
2131B	051128-59166	2-part pouch	7.5 oz (213 g)	10.6 (175)	10
2131C	051128-59167	2-part pouch	21.5 oz (612 g)	30.6 (502)	10
2131-Part A 5 Gal	051128-59181	5 gallon jug, Part A	44.5 lb (20.1 kg)		1 pail
2131-Part B 5 Gal	051128-59182	5 gallon jug, Part B	46.5 lb (21 kg)		1 pail

3M™ Resin Splice Kits

3M™ Scotchcast™ Potting Kit 2136

The 3M™ Scotchcast™ Potting Kit 2136 is designed to provide protection against corrosion and possible deteriorating effects of fresh swimming pool or fountain water and sunlight by reliably encapsulating the 8 AWG ground connection in a wet-niche shell as required by NEC® when using rigid, non-metallic conduit in the installation of wet-niche

underwater lighting fixtures. Scotchcast 2136 compound is UL Listed as a potting compound for swimming pool, fountain, or spa equipment and is for use only where adhering to copper, copper alloy and stainless steel materials.

3M™ Scotchcast™ Potting Compound 2136 is a thixotropic polyurethane resin, designed to resist dripping or sagging, and contained in an easy mix 1.5 oz. closed mixing pouch. At temperatures above 40°F (18°C) the compound will firm up in minutes. Encapsulated connections should be allowed to cure for 4 hours prior to submersion.

Voltage	Up to 1000 Volts; UL Listed up to 600 Volts
Cure Time	4 Hours at 70°F (21°C)
Energize Time	Immediately
Max. Operating Temperature	UL Listed 20L02 220°F (105°C)
Color	Black
RoHS 2011/65/EU	Yes



Order No.	UPC	Material	Weight, oz (g)	Containers per Case
2136	051128-59190	Potting Compound	1.50 (42,5)	10

3M™ Resin Splice Kits

3M™ Resin Pressure System Components

The 3M™ Resin Pressure System is comprised of several components used for constructing splices or splice jackets on medium voltage power cables for harsh environments. 3M™ Scotchcast™ Electrical Insulating Resin 4 is a key component of the system, which can be used as the primary insulation for shielded and non-shielded splices rated up to 8 kV. The system is also available as a resin-jacketed tape splice (TapeCast) rated up to 25 kV. The resin is a two-part epoxy, packaged in a special Unipak container that provides the exact mixing ratio for making a strong, dependable and long-lasting splice or splice jacket. The versatile resin system accommodates a variety of splice configurations and cables.

A resin pressure system splice is suitable for submerged locations (e.g. manholes and vaults), underground direct burial, and aerial applications. All parts are ordered separately. Contact your local 3M representative for further details.



3M™ Resin Pressure System Components

Voltage Class	Number of Conductors	Shielding	Insulation Material	Splice Configuration
5 and 8 kV	1/C, multi/C and Transitions from Multi-to single conductor	Non-shielded, Tape Shielded, Wire Shielded, UniShield®, LC, CN and JCN	Solid Dielectric (EPR, XLPE, etc.), PILC and transitions from PILC to Solid Dielectric	Inline, Wye and Tee Resin Splice
15 kV	1/C, multi/C and Transitions from Multi-to single conductor	Tape Shielded, Wire Shielded, UniShield®, LC, CN and JCN	Solid Dielectric (EPR, XLPE, etc.), PILC and transitions from PILC to Solid Dielectric	Inline and Tee TapeCast™ Splice
25 kV	1/C, multi/C and Transitions from Multi-to single conductor	Tape Shielded, Wire Shielded, UniShield®, LC, CN and JCN	Solid Dielectric (EPR, XLPE, etc.), PILC and transitions from PILC to Solid Dielectric	Inline and Tee TapeCast™ Splice

These Resin and 3M™ TapeCast™ Splices will also work on sector shaped conductors.

Order No.	UPC	Product Name	Description	Case Qty.
E-4	054007-25701	3M™ Resin Pressure Gun E-4	Reusable resin pressure gun used for constructing a resin pressure splice.	1
P-1B	054007-11857	3M™ Scotchcast™ Injection Fitting P-1B	Enables safe transfer of resin through gun and into the joint.	5
P-3	054007-25735	3M™ Scotchcast™ Spacer Tape P-3	Used to build up voids in odd shaped splices, ensures full resin coverage, and forms a liquid tight mold. 27' x 1-1/2" (8,23 m x 38,1 mm)	50
P-4	054007-25743	3M™ Cloth Tape P-4	Restrictor Tape, 1" x 30' on 1" core.	50
P-5B	054007-11858	3M™ Scotchcast™ Injection Nozzle P-5B	Used to puncture compound bag and pipe compound to P-1B injection fitting. Mastic seal prevents spillage.	5

3M™ Cold Shrink Connector Insulators 8420 and 8430 Series

3M™ Cold Shrink Connector Insulators 8420 and 8430 Series are designed using 3M's proprietary cold shrink delivery system. Products are supplied prestretched on a removable core for efficiency and ease of installation. Removal of the core (unwinding) after positioning the splice allows the product to shrink into position forming a moisture-tight seal. The live memory action of the specially formulated EPDM material promotes a permanent, durable environmental seal and insulation, with a typical operating temperature range from -40–194°F (-40–90°C).

The 8420 insulator meets requirements of ANSI C119-1 and Western Underground Guide 2.14 for secondary splices rated up to 1 kV.

Important: Use insulation jacket or connector O.D. for final ordering criteria.

* Mastic pads included for cable O.D. build-up. ** Kit contains adapters. *** These sizes are listed for availability only and are not designed to be used as primary insulation. These tubes are for conduit sealing and breakouts. ****Maximum connector length: 5.625"

"Point of Purchase" packaging designated by "P". Example: 8423-6P

Voltage	1000 V or less
Number of Conductors	Single Conductor
Cable Type	Low Voltage Single Conductor Insulated Cable
Splice Type	Cold Shrink
Applications	Primary electrical insulation for all solid dielectric (rubber and plastic) insulated wire and cable splicing rated to 1000 V. Good for repairs and environmental sealing for communication and other non-electrical applications.
RoHS 2011/65/EU	Yes
Agency Approvals	ANSI C1191.1



Order No.	UPC	Typical Conductor Size	Min. Cable Dia. for Seal	Max. Dia. Insulator Cable or Connector Covers	Max. Connector Length	Relaxed Tube Length	Case Qty.
8423-6	054007-42146	6-4 AWG (14-16 mm ²)	0.31" (7,8 mm)	0.56" (14,2 mm)	2.0" (50,8 mm)	6.0" (152,4 mm)	10
8423-6P	054007-42864	6-4 AWG (14-16 mm ²)	0.31" (7,8 mm)	0.56" (14,2 mm)	2.0" (50,8 mm)	6.0" (152,4 mm)	10
8424-8**	054007-42390	10-1/0 AWG (6-16 mm ²)	0.10" (2,5 mm)	0.82" (20,9 mm)	3.0" (76,2 mm)	8.0" (203,2 mm)	10
8424-8P	054007-42865	10-1/0 AWG (6-16 mm ²)	0.10" (2,5 mm)	0.82" (20,9 mm)	3.0" (76,2 mm)	8.0" (203,2 mm)	10
8425-8	054007-42391	2-1/0 AWG (35-50 mm ²)	0.40" (10,1 mm)	0.82" (20,9 mm)	3.0" (76,2 mm)	8.0" (203,2 mm)	10
8425-8P	054007-42866	2-1/0 AWG (35-50 mm ²)	0.40" (10,1 mm)	0.82" (20,9 mm)	3.0" (76,2 mm)	8.0" (203,2 mm)	10
8426-9	054007-34457	2/0 AWG-250 kcmil (70-125 mm ²)	0.55" (13,9 mm)	1.18" (30,1 mm)	5.0" (127,0 mm)	9.0" (228,6 mm)	10
8426-9M*	054007-43436	2-4/0 AWG (30-90 mm ²)	0.40" (10,1 mm)	1.18" (30,1 mm)	5.0" (127,0 mm)	9.0" (228,6 mm)	10
8426-9P	054007-42867	2/0 AWG-250 kcmil (70-125 mm ²)	0.55" (13,9 mm)	1.18" (30,1 mm)	5.0" (127,0 mm)	9.0" (228,6 mm)	10
8426-11	054007-34458	2/0 AWG-250 kcmil (70-125 mm ²)	0.55" (13,9 mm)	1.18" (30,1 mm)	7.0" (177,8 mm)	11.0" (279,4 mm)	10
8427-6***	054007-09915	-	0.67" (16,8 mm)	1.38" (35,1 mm)	2.0" (50,8 mm)	6.0" (152,4 mm)	10
8427-12	054007-34459	250-400 kcmil (125-200 mm ²)	0.67" (16,8 mm)	1.38" (35,1 mm)	8.0" (203,2 mm)	12.0" (304,8 mm)	10
8427-12P	054007-42868	250-400 kcmil (125-200 mm ²)	0.67" (16,8 mm)	1.38" (35,1 mm)	8.0" (203,2 mm)	12.0" (304,8 mm)	10
8427-16	054007-34460	250-400 kcmil (125-200 mm ²)	0.67" (16,8 mm)	1.38" (35,1 mm)	12.0" (304,8 mm)	16.0" (406,4 mm)	10
8428-6***	054007-09916	-	0.95" (24,1 mm)	1.94" (49,2 mm)	2.0" (50,8 mm)	6.0" (152,4 mm)	10

3M™ Cold Shrink Connector Insulators 8420 and 8430 Series (continued)

Order No.	UPC	Typical Conductor Size	Min. Cable Dia. for Seal	Max. Dia. Insulator Cable or Connector Covers	Max. Connector Length	Relaxed Tube Length	Case Qty.
8428-6M	051128-53828	450-800 kcmil (240-400 mm ²)	0.95" (24,1 mm)	1.94" (49,2 mm)	2.0" (50,8 mm)	6.0" (152,4 mm)	50
8428-8	051128-53711	500-800 kcmil (300-400 mm ²)	0.95" (24,1 mm)	1.94" (49,2 mm)	3.0" (76,2 mm)	8.0" (203,2 mm)	25
8428-12	054007-09056	500-800 kcmil (300-400 mm ²)	0.95" (24,1 mm)	1.94" (49,2 mm)	8.0" (203,2 mm)	12.0" (304,8 mm)	10
8428-12M	054007-43746	500-800 kcmil (300-400 mm ²)	0.95" (24,1 mm)	1.94" (49,2 mm)	8.0" (203,2 mm)	12.0" (304,8 mm)	10
8428-12P	054007-42869	500-800 kcmil (300-400 mm ²)	0.95" (24,1 mm)	1.94" (49,2 mm)	8.0" (203,2 mm)	12.0" (304,8 mm)	10
8428-18	054007-34461	500-800 kcmil (300-400 mm ²)	0.95" (24,1 mm)	1.94" (49,2 mm)	14.0" (355,6 mm)	18.0" (457,2 mm)	10
8429-6***	054007-09917	-	1.27" (32,2 mm)	2.67" (67,8 mm)	2.0" (50,8 mm)	6.0" (152,4 mm)	10
8429-9****	054007-09931	900-1000 kcmil (500 mm ²)	1.27" (32,2 mm)	2.67" (67,8 mm)	5.0" (127,0 mm)	9.0" (228,6 mm)	10
8429-9M	054007-42018	900-1000 kcmil (500 mm ²)	1.27" (32,2 mm)	2.67" (67,8 mm)	5.0" (127,0 mm)	9.0" (228,6 mm)	10
8429-12	054007-42389	900-1000 kcmil (500 mm ²)	1.27" (32,2 mm)	2.67" (67,8 mm)	8.0" (203,2 mm)	12.0" (304,8 mm)	10
8429-15	054007-44198	900-1000 kcmil (500 mm ²)	1.27" (32,2 mm)	2.67" (67,8 mm)	11.0" (279,4 mm)	15.0" (381,0 mm)	10
8429-18	054007-34462	900-1000 kcmil (500 mm ²)	1.27" (32,2 mm)	2.67" (67,8 mm)	14.0" (355,6 mm)	18.0" (457,2 mm)	10
8430-9***	054007-42147	1250-2000 kcmil	1.68" (42,6 mm)	3.69" (93,7 mm)	5.0" (127,0 mm)	9.0" (228,6 mm)	10
8430-18	054007-42388	1250-2000 kcmil	1.68" (42,6 mm)	3.69" (93,7 mm)	14.0" (355,6 mm)	18.0" (457,2 mm)	10

3M™ Cold Shrink Splice Kits

3M™ Cold Shrink Silicone Insulators 8440 Series (1000 Volts or less)

3M™ Cold Shrink Silicone Insulators 8440 Series are insulating sleeves made from a specially formulated high-temperature silicone rubber with a typical operating temperature range of -67–500°F (-55–260°C).



Single Conductor Cable

Voltage	1000 V or less
No. of Conductors	Single Conductor
Cable Type	Low Voltage Single Conductor Insulated Cable
Splice Type	Cold Shrink
Application	Primary electrical insulation for all solid dielectric (rubber and plastic) insulated wire and cable splices rated to 1000 V.
RoHS 2011/65/EU	Yes



Order No.	UPC	Typical Conductor Size	Min. Cable Diameter for Seal	Max. Diameter Insulator Cable or Connector Covers	Relaxed Tube Length	Case Qty.
8443-2	054007-09485	6–2 AWG (14–30 mm ²)	0.30" (7,6 mm)	0.56" (14,2 mm)	2.00" (50,8 mm)	12
8443-3	051128-57098	6–2 AWG (14–30 mm ²)	0.30" (7,6 mm)	0.56" (14,2 mm)	2.00" (50,8 mm)	12
8443-6.5	054007-09482	6–2 AWG (14–30 mm ²)	0.30" (7,6 mm)	0.56" (14,2 mm)	6.50" (165,1 mm)	12
8445-2.5	054007-09486	2–1/0 AWG (35–50 mm ²)	0.37" (9,4 mm)	0.72" (18,3 mm)	2.50" (63,5 mm)	12
8445-7.5	054007-09483	2–1/0 AWG (35–50 mm ²)	0.37" (9,4 mm)	0.72" (18,3 mm)	7.50" (190,5 mm)	12
8447-3.2	054007-09487	1/0–3/0 AWG (60–80 mm ²)	0.49" (12,4 mm)	0.95" (24,1 mm)	3.20" (81,3 mm)	12
8447-8	054007-09484	1/0–3/0 AWG (60–80 mm ²)	0.49" (12,4 mm)	0.95" (24,1 mm)	8.00" (203,2 mm)	12

3M™ Cold Shrink Splice Kits

3M™ Cold Shrink Quick Insulator QI Series

3M™ Cold Shrink Quick Insulator QI Series are open-ended tubular rubber sleeves with sealing mastic on each end that are factory expanded and assembled onto a removable core. The core is removed by pulling from one end after the QI insulator has been positioned over an inline connector, allowing the ends of the tube to shrink and form a water-resistant seal. Sizing of the core and tube, along with the sealing mastic on each end, provides a broader application range without degrading the seal and insulating characteristics of the EPDM rubber tube. Three diameter sizes will cover a range of 1 kV or less cable from 8 AWG–1250 kcmil, copper and aluminum conductors with crimped connectors.



Single Conductor Cable

Voltage	1000 V or less
Number of Conductors	Single Conductor
Cable Type	Low Voltage Single Conductor Insulated Cable
Splice Type	Cold Shrink
Applications	Insulating and protecting low voltage splices in direct bury secondary low voltage applications.
RoHS 2011/65/EU	Yes
Agency Approvals	ANSI C-119.1



Order No.	UPC	Conductor Size, Cu	Conductor Size, Al	Cable Insulation O.D.	Max. Connector O.D.	Max Connector Length	Case Qty.
QI-5/16-220	051128-57750	8–2/0 AWG	8–1/0 AWG	0.20"–0.65" (5,1–16,5 mm)	0.65" (16,5 mm)	2.75" (69,9 mm)	10
QI-10/37-270	051128-57698	2 AWG–750 kcmil	2 AWG–500 kcmil	0.40"–1.45" (10,2–36,8 mm)	1.45" (36,8 mm)	4.50" (114,3 mm)	10
QI-18/57-325	051128-57751	250–1250 kcmil	250–1250 kcmil	0.71"–2.25" (18,0–57,2 mm)	2.25" (57,2 mm)	6.00" (152,4 mm)	10

3M™ Cold Shrink Splice Kits

3M™ Cold Shrink Quick Splice Low Voltage QSLV-M Series

3M™ Cold Shrink Quick Splice Low Voltage QSLV-M are open-ended tubular rubber sleeves with sealing mastic on each end which are factory expanded and assembled onto a unique three-core system. Two cores, one on each end, are removed after the QSLV-M insulator has been centered over an inline connector, allowing the ends of the tube to shrink and form a water-resistant seal. The third, center segment of the core remains inside the cold shrink tube, acting as a support structure. Sizing of the cores and tube, along with the sealing mastic on each end, is designed to accommodate the variance in connectors and connector crimping techniques and final dimensions without degrading the seal and insulating characteristics of the EPDM rubber tube, while also making core removal easy. Two diameter sizes will cover a range of 1 kV or less cable from 8 AWG through 500 kcmil, copper and aluminum conductors with crimped connectors.

In aerial applications where intense UV radiation will be common and visual inspection is not possible, it is recommended to overwrap the tubing with Scotch® Super 33+™ Vinyl Electrical Tape or Scotch® Self-Fusing Silicone Rubber Electrical Tape 70.

Note: Insulator may be used on cable sizes outside of the recommended range provided both cables are within the insulation O.D. range, and the connector meets the dimensional requirements shown in the table.

Voltage	1000 V or less
Number of Conductors	Single Conductor
Cable Type	Low Voltage Single Conductor Insulated Cable
Splice Type	Cold Shrink
Applications	Insulating and protecting low voltage splices in direct bury secondary low voltage applications.
RoHS 2011/65/EU	Yes
Agency Approvals	ANSI C119.1



Order No.	UPC	Cable Size, Al	Cable Size, Cu	Cable Insulation O.D.	Max. Connector O.D.	Max. Connector Length	Case Qty.
QSLV-M(8-2/0)	051128-57236	8-2/0 AWG	8-3/0 AWG	0.20"-0.75" (5-19 mm)	0.687" (17 mm)	2.50" (63 mm)	10
QSLV-M(2-500)	051128-57237	2 AWG-500 kcmil	2 AWG-1000 kcmil	0.40"-1.60" (10-41 mm)	1.500" (38 mm)	4.25" (108 mm)	10

3M™ Cold Shrink Splice Kits

3M™ Cold Shrink Connector Insulator WF Series

3M™ Cold Shrink Connector Insulator WF Series are designed using 3M's unique cold shrink delivery system. Products are supplied pre-stretched on a removable core for efficiency and ease of installation. Removal of the core (unwinding) after positioning the splice allows the product to shrink into position forming a moisture tight seal. The live memory action of the specially formulated EPDM material promotes a permanent, durable environmental seal and insulation, with typical operating range from 40° to 194°F (-40° to 90°C).

Voltage	2000 V or less
Number of Conductors	Single Conductor
Cable Type	Low Voltage Single Conductor Insulated Cable
Splice Type	Cold Shrink
Applications	Primary electrical insulation for all solid dielectric (rubber and plastic) insulated wire and cable splices rated to 2000 volts. Direct bury or submersible, indoor and outdoor, lug connections to bus bar, insulation of secondary splices, copper or aluminum conductors, relocation of service, dig in and sheath repairs, wind farm down tower applications, environmental sealing for communication and other non-electrical applications and insulation of inline conductor transition connector.
RoHS 2011/65/EU	Yes
Agency Approvals	UL listed in US and Canada

Order No.	UPC	Conductor Size AWG & kcmil	Product Diameter Range Inches (mm)	Min. Order Qty.	Case Qty.
WF100	051128-60145	4-2 AWG	0.35"-0.56" (8,9-14,2 mm)	10	10
WF101	051128-60146	1-2/0 AWG	0.45"-0.82" (11,4-20,8 mm)	10	10
WF102	051128-60147	3/0 AWG-250 kcmil	0.62"-1.18" (15,7-30,1 mm)	10	10
WF103	051128-59546	350-500 kcmil	0.88"-1.63" (22,4-41,4 mm)	10	10
WF104	051128-60148	600-750 kcmil (Al) 600-1000 kcmil (Cu)	1.00"-1.94" (25,4-49,3 mm)	10	10

3M™ Cold Shrink Splice Kits

3M™ Inline Splices for 3/C or 4/C Armored Power Cable (Teck-90) 5730 Series

These kits are applicable for indoor and outdoor installations, including direct burial, aerial and submersible applications. Each kit requires at least 1 roll of 3M™ Armorcast Structural Material. For use with 3/C or 4/C Armor Power Cable (Teck-90) up to 1000 V.

3M™ 3/C Armored Power Cable 5730 Series accommodates a full range of cable sizes from 14 AWG–750 kcmil. The overall jacket diameter ranges from 0.62–4.00" (16–102 mm).

Notes

- ♦ Connectors are not included in the kit. Use only CSA certified compression connectors. Vinyl or nylon butt connectors are preferred.
- ♦ Amount of armorcast needed is based on two half-lapped layers and 15' rolls.

Voltage	1000 V or less
Number of Conductors	Multiple Conductor
Cable/Shielding Type	Armor Power Cable (Teck 90)
Splice Type	Inline
RoHS 2011/65/EU	Yes
	
Agency Approvals	Certified for 600 V or less CSA Approved for use in the United States and Canada



Order No.	UPC	Voltage	Conductor Size	Overall Jacket Diameter	Number of Conductors	Amount of 3M™ Armorcast Required	Case Qty.
5730	054007-43171	0–600 V	14–10 AWG	0.62"–1.00" (15,7–25,4 mm)	3/C or 4/C	1 roll	1
5731	054007-43172	0–600 V	8–4 AWG	0.95"–1.40" (24,1–35,6 mm)	3/C or 4/C	1 roll	1
5732	054007-43173	0–1000 V	2–1/0 AWG	0.95"–2.40" (24,1–61,0 mm)	3/C only	1 roll	1
5733	054007-43174	0–1000 V	2/0 AWG–250 kcmil	1.15"–3.30" (29,2–83,8 mm)	3/C only	2 rolls	1
5734	054007-43175	0–1000 V	250–500 kcmil	1.55"–4.00" (39,4–101,6 mm)	3/C only	2 rolls	1
5735	054007-43176	0–1000 V	500–750 kcmil	1.55"–4.00" (39,4–101,6 mm)	3/C only	3 rolls	1



3M™ Cold Shrink Splice Kits

3M™ Resin/Cold Shrink Non-Shielded, Armored or Non-Armored Splice Kits 5750 Series

3M™ Resin/Cold Shrink 5750 Series splice kits are designed for non-shielded armored and non-armored solid dielectric cables rated up to 5 kV. Each kit makes one 3/C splice. Connectors are not included and must be ordered separately.

* Splice diameter varies according to cable size (O.D.).

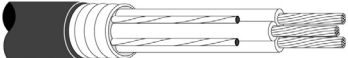
Note: Cable sizes shown below are for standard insulation thickness. Final determining factor is cable insulation O.D.

<p>Voltage 1 kV, 5 kV</p> <p>Number of Conductors Three Conductor</p> <p>Shielding Type Non-Armored (Non-Shielded), Armored (Non-Shielded)</p> <p>Splice Type Inline</p> <p>Technology Cold Shrink, Resin</p> <p>Conductor Material Aluminum, Copper</p> <p>RoHS 2011/65/EU Yes</p> <p>Agency Approval Mine Safety and Health Administrations Acceptance: 07-KA060007-MSHA</p>	 <p>Three-Conductor Armored, Nonshielded Cable</p>  <p>Three-Conductor Non-Armored, Nonshielded Cable</p>	
--	---	---

Order No.	UPC	Insulation O.D. Range	1 kV Conductor Size, Copper or Aluminum	5 kV Conductor Size, Copper or Aluminum	Splice Diameter Range*	Typical Splice Length	Case Qty.
5751	051128-59169	0.50"-0.95" (13-24 mm)	1-3/0 AWG (50-95 mm ²)	6-1 AWG (14-50 mm ²)	1.5"-2.5" (38,1-63,5 mm)	19.0" (483 mm)	1
5752	051128-59168	0.66"-1.25" (17-31 mm)	4/0 AWG-350 kcmil (120-185 mm ²)	1/0 AWG-350 kcmil (60-185 mm ²)	2.5"-4.0" (63,5-101,6 mm)	28.0" (711 mm)	1
5753	051128-59171	0.95"-1.80" (24-46 mm)	350-750 kcmil (185-400 mm ²)	350-750 kcmil (185-400 mm ²)	3.5"-6.0" (88,9-152,4 mm)	42.0" (1067 mm)	1

3M™ Cold Shrink Splice Kits

3M™ Cold Shrink Portable Cable Splice Kits 2237A and 2238A

3M™ Cold Shrink Portable Cable Splice Kits 2237A and 2238A are designed to splice SO and SJ type portable power cables (commercial grade extension cords) which are typically used in industrial environments. The 2237A kit accommodates 4-conductor 12-10 AWG and the 2238A kit accommodates 4-conductor 8 AWG.

The primary application for the kits is splicing damaged portable cable. The kits can be used for cables aboard ships, cargo operations and a variety of industrial applications.

Each kit contains:

- Cold shrink tube
- Butt connectors
- Rubber phase
- Divider mastic strips
- Scotch® Vinyl Electrical Color-Coding Tape 35
- Instructions

Voltage	1000 V or less
Number of Conductors	Single Conductor
Cable/Shielding Type	SO, SJ
Splice Type	Cold Shrink
Application	Splicing damaged portable cable.
RoHS 2011/65/EU	Yes

Order No.	UPC	Conductor Size	Cable O.D.	Case Qty.
2237A	054007-41317	12-10 AWG (6 mm ²)	0.62" (0.96 mm)	10
2238A	054007-41318	8 AWG (10 mm ²)	0.62" (0.96 mm)	10



Medium Voltage Splice Kits, 5 kV–46 kV

3M™ Splice Solutions are designed to help you reduce the time, labor and cost involved in a variety of electrical cable splicing applications. The 3M product line covers splicing needs from 5 kV-46 kV applications, and utilizes field-proven technologies to provide dependable performance, stability and long life with every splice you make. With 3M, you can choose the right splice to fit your specific needs.

Cold Shrink Splices

3M™ Cold Shrink splicing products are designed using 3M's proprietary cold shrink delivery system. Products are supplied pre-stretched on a removable core for efficiency and ease of installation. The removable core unwinds after positioning the splice, allowing the product to shrink into position and form a moisture resistant seal. The live-memory action of the specially formulated material ensures a permanent, durable environmental seal and insulation. All 3M™ Cold Shrink QS-III medium voltage (5 kV-46 kV) kits meet the requirements of IEEE-404, and each splice is factory tested on power cable to ensure long-term reliability and quality. 3M QS-III splices can be used for direct burial applications, as well as in manholes, vaults, cable trays, and junction boxes. All 3M cold shrink products require no special tools, flame or training to install.

Molded Rubber Splices

3M™ Molded Rubber QS and QS-II kits are molded from specially formulated, peroxide cured, EPDM rubber to provide a reliable medium voltage inline splice with a life expectancy equal to the cable. All 3M medium voltage (15 kV-35 kV) QS Series meet the requirements of IEEE-404, and each splice is factory tested.

PILC Splices

3M™ Cold Shrink splice kits for Paper Insulated Lead Covered (PILC) cable use 3M patented oil stop technology. Kits install without soldering or lead wiping. 3M Cold Shrink PILC splices allow quick installation time without the need of an open flame or heat. Single conductor splice kits allow inline splicing of PILC to PILC or PILC to Poly/EPR insulated cable. Three conductor cable splices kits are



designed to transition splice three conductor PILC to three single conductor poly/EPR insulated cables. All splices are jacketed and can be fully submersed. Modular splice kits are available for single conductor PILC equipment connections and tap splicing.

Resin Splices

3M™ Resin Splice Kits are used in a variety of applications where conditions require the unique properties of 3M resins. The splicing kits have a high degree of mechanical strength for physical protection of connections and provide moisture-resistant insulation in above ground or direct burial applications.

Tape Splices

When you want the versatility of tape, Scotch® Cable Splicing Kits are the answer for almost any application, regardless of cable type or size. Scotch® rubber splicing tape is designed for extra-long shelf life, so there's less chance of being caught without the supplies you need for emergencies. Tape products are available to splice cables from 2 kV-69 kV.

Section	Page
5 kV.....	181-182
5/8 kV.....	183-189
15 kV.....	190-209
25/28 kV.....	210-221
35 kV.....	222-230
46 kV.....	231-232



Technology Features

Technology	Installation Time (1-5, 1=Fastest)	Installation Ease (1-5, 1=Easiest)	Wide Application Range (1-5, 1=Greatest)	Factory Tested	Re-Jacketing Included
Cold Shrink	1	1	2	Yes	Yes
Push On/Molded Rubber	2	2	4	Yes	No
Resin	3	3	3	No	Yes
Tape	4	4	1	No	Yes

5 kV Medium Voltage Splice Reference

①	Three Conductor (3/C)
②	Non-shielded
③	3M™ Cold Shrink Splice Kits 
3M™ Resin/Cold Shrink Non-Shielded, Armored or Non-Armored Splice Kits 5750 Series	

5/8 kV Medium Voltage Splice Reference

①	Single Conductor (1/C)	Three Conductor (3/C)			
②	Shielded		Non-shielded	Tape Shield, Wire Shield, UniShield®, Longitudinally Corrugated (LC)	
③	3M™ Cold Shrink Splice Kits 	3M™ Tape Splice Kits	3M™ Cold Shrink Splice Kits 	3M™ Cold Shrink Splice Kits 	
	3M™ Cold Shrink Shielded Splice Kits 5550 Series	Scotch® Inline and Tee Tape Shielded Cable Splice Kits 5700 Series	3M™ Cold Shrink Inline Non-Shielded Splice Kits 5740 Series	3M™ Cold Shrink/Armorcast, Armored or Non-Armored Splice Kit 5551-3C-AC	3M™ Cold Shrink QS-III Armored or Non-Armored Cable Splice Kits 5775A-MT, 5776A-MT & 5777A-MT
					3M™ Cold Shrink Inline Shielded, Armored or Non-Armored Splice Kits 5760 Series

15 kV Medium Voltage Splice Reference

1 Single Conductor (1/C)									
2 Concentric Neutral (CN) and Jacketed Concentric Neutral (JCN)				Tape Shield, Wire Shield, UniShield®, Longitudinally Corrugated (LC)				Paper Insulated Lead Cover (PILC)	
3 3M™ Cold Shrink Splice Kits (non-PILC) <small>QUICK TO INSTALL</small>		3M™ Molded Rubber Splice Kits		3M™ Tape Splice Kits		3M™ Cold Shrink Splice Kits (non-PILC) <small>QUICK TO INSTALL</small>		3M™ Molded Rubber Splice Kits	3M™ Tape Splice Kits
3M™ Cold Shrink Splice Kits (non-PILC) <small>QUICK TO INSTALL</small>		3M™ Molded Rubber Splice Kits		3M™ Tape Splice Kits		3M™ Cold Shrink Splice Kits (non-PILC) <small>QUICK TO INSTALL</small>		3M™ Molded Rubber Splice Kits	3M™ Tape Splice Kits
Inline	Branch			Inline	Branch				
3M™ Cold Shrink QS-III In-line JCN/CN Splice Kits 5415A, 5416A, 5417A, 5418A	3M™ Cold Shrink Branch JCN and Shielded Splice Kits QS-2001B	3M™ Molded Rubber QS In-line JCN/CN Splice Kits 5400 Series	Scotch® In-line and Tee Tape Shielded Cable Splice Kits 5700 Series	3M™ Cold Shrink QS-III Shielded Cable Splice Kits 5513A, 5514A, 5515A and 5516A Series	3M™ Cold Shrink Branch Splice Kits QS 2001B	3M™ Molded Rubber QS-II In-line Shielded Cable Splice Kits 5500 Series	Scotch® In-line and Tee Tape Shielded Cable Splice Kits 5700 Series	3M™ Cold Shrink 1/C In-line Transition Splice Kit QS-III, 5510A-1T-PILC Series	
		3M™ Molded Rubber QS-II In-line JCN/CN Splice Kits 5411, 5411A and 5412 Series						3M™ Cold Shrink Splice Kit QS-2000T 1/C PILC to 1/C Poly/EPR or 1/C PILC to 1/C PILC Cable Splices	
		3M™ Molded Rubber QS-II JCN/CN Cable Repair Splice Kit 5411R and 5412R Series							

1 Three Conductor (3/C)		
2 Tape Shield, Wire Shield, UniShield®, Longitudinally Corrugated (LC)		Paper Insulated Lead Cover (PILC)
3 3M™ Cold Shrink Splice Kits (non-PILC) <small>QUICK TO INSTALL</small>		3M™ Cold Shrink Splice Kits <small>QUICK TO INSTALL</small>
3M™ Cold Shrink Splice Kits (non-PILC) <small>QUICK TO INSTALL</small>		3M™ Cold Shrink Splice Kits <small>QUICK TO INSTALL</small>
3M™ Cold Shrink QS-III Armored, Non-Armored Cable Splices Kits 5775A-MT, 5776A-MT & 5777A-MT	3M™ Cold Shrink and Resin Splice Kits (non-PILC) <small>QUICK TO INSTALL</small>	3M™ Cold Shrink Splice Kits <small>QUICK TO INSTALL</small>
3M™ Cold Shrink QS-III Armored, Non-Armored Cable Splices Kits 5775A-MT, 5776A-MT & 5777A-MT	3M™ Cold Shrink 3/C In-line Shielded, Armored or Non-Armored Splice Kits 5760 Series	3M™ Cold Shrink 3/C PILC to 3/C Poly/EPR Cable Transition Splice Kit QS-2013-3T-3C
		3M™ Cold Shrink Splice Kit QS-2000-3T and QS-2000-3T-WS 3/C PILC to 1/C Poly/EPR Cable Trifurcating Splices

25/28 kV Medium Voltage Splice Reference

① Single Conductor (1/C)			Three Conductor (3/C)		
② Concentric Neutral (CN) and Jacketed Concentric Neutral (JCN)			Tape Shield, Wire Shield, UniShield®, Longitudinally Corrugated (LC)	Paper Insulated Lead Cover (PILC)	Tape Shield, Wire Shield, UniShield®, Longitudinally Corrugated (LC)
③ 3M™ Cold Shrink Splice Kits (non-PILC) <small>QUICK TO INSTALL</small>	3M™ Molded Rubber Splice Kits		3M™ Cold Shrink Splice Kits (non-PILC) <small>QUICK TO INSTALL</small>	3M™ Cold Shrink Splice Kits <small>QUICK TO INSTALL</small>	3M™ Cold Shrink Splice Kits (non-PILC) <small>QUICK TO INSTALL</small>
3M™ Cold Shrink QS-III Inline CN/JCN Cable Splice Kits 5456A, 5457A and 5458A	3M™ Molded Rubber QS-II Inline CN/JCN Cable Splice Kits 5420 Series	3M™ Molded Rubber QS-II Inline CN/JCN Cable Splice Kit 5450 Series	3M™ Cold Shrink QS-III Inline Shielded Cable Splice Kits 5524A, 5525A and 5526A	3M™ Cold Shrink 1/C Transition Splice Kit QS-III 5520A-1T-PILC Series	3M™ Cold Shrink QS-III 3/C Inline Armored or Non-Armored Cable Splice Kits 5786A-MT, 5787A-MT and 5788A-MT
		3M™ Molded Rubber QS-II JCN Cable Repair Splice Kit 5451R Series			

35 kV Medium Voltage Splice Reference

① Single Conductor (1/C)			Three Conductor (3/C)		
② Concentric Neutral (CN) and Jacketed Concentric Neutral (JCN)			Tape Shield, Wire Shield, UniShield®, Longitudinally Corrugated (LC)	Paper Insulated Lead Cover (PILC)	Tape Shield, Wire Shield, UniShield®, Longitudinally Corrugated (LC)
③ 3M™ Cold Shrink Splice Kits (non-PILC) <small>QUICK TO INSTALL</small>	3M™ Molded Rubber Splice Kits	3M™ Cold Shrink Splice Kits (non-PILC) <small>QUICK TO INSTALL</small>	3M™ Cold Shrink Splice Kits <small>QUICK TO INSTALL</small>	3M™ Cold Shrink Splice Kits (non-PILC) <small>QUICK TO INSTALL</small>	
3M™ Cold Shrink QS-III Inline CN/JCN Cable Splice Kits 5467A and 5468A	3M™ Molded Rubber QS CN/JCN Cable Splice Kits 5432 and 5433	3M™ Cold Shrink QS-III Inline Shielded Cable Splice Kits 5535A and 5536A	3M™ Cold Shrink QS-III Inline Shielded Cable Splice Kits 5530A-1T-PILC Series	3M™ Cold Shrink QS-III 3/C Armored or Non-Armored Splice Kits 5797A-MT and 5798A-MT	
3M™ Cold Shrink QS-III CN/JCN Cable Shield-Break Splice Kits 5467A-XB and 5468A-XB	3M™ Molded Rubber QS-II CN/JCN Cable Splice Kits 5461				

46 kV Medium Voltage Splice Reference

①	Single Conductor (1/C)
②	Shielded
③	3M™ Cold Shrink Splice Kits (non-PILC) <small>QUICK TO INSTALL</small>
3M™ Cold Shrink QS-III Inline Shielded Splice Kit 5545A	

*For higher voltages, see High Voltage section of catalog.

Cable Types for Medium Voltage Splicing

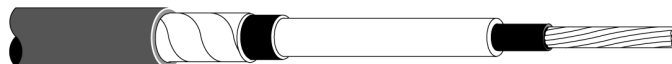

Tape Shielded Cable

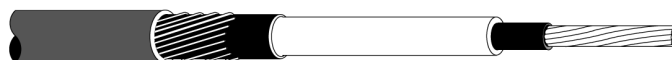

Wire Shielded Cable

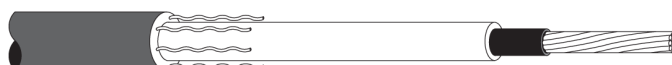

UniShield® Cable



Longitudinally Corrugated (LC) Shielded Cable



EP-Lead or XLP-Lead Cable



Concentric Neutral (CN) Cable



Jacketed Concentric Neutral (JCN) Cable



Paper Insulated Lead Covered (PILC) Cable

Cable Types for Medium Voltage Splicing



Non Shielded (Dry) Cable



Non Shielded (Wet or Dry) Cable

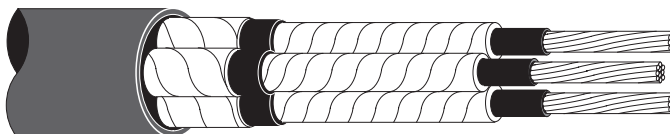

Three-Conductor Paper Insulated Lead Covered (PILC) Cable

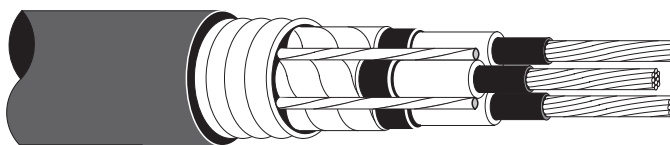

Three-Conductor Armored, Shielded Cable



Three-Conductor Non-Armored, Shielded Cable

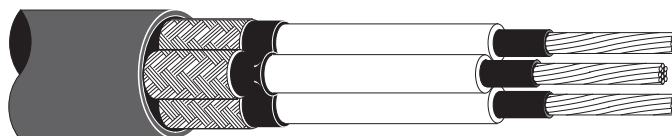

Three-Conductor Portable Cable Type SHD-GC

5 kV Medium Voltage Splices

The following 3M products cover splicing needs for applications up to 5 kV, and promote dependable performance, stability and long life with every splice you make.



Section	Page
5 kV	181-182
Non-Shielded	182
Three Conductor (3/C)	182
3M™ Resin/Cold Shrink Non-Shielded, Armored or Non-Armored Splice Kits 5750 Series	182



5 kV: Non-Shielded: Three Conductor (3/C)

3M™ Resin/Cold Shrink Non-Shielded, Armored or Non-Armored Splice Kits 5750 Series

3M™ Resin/Cold Shrink 5750 Series splice kits are designed for non-shielded armored and non-armored solid dielectric cables rated up to 5 kV. Each kit makes one 3/C splice. Connectors are not included and must be ordered separately.

* Splice diameter varies according to cable size (O.D.).

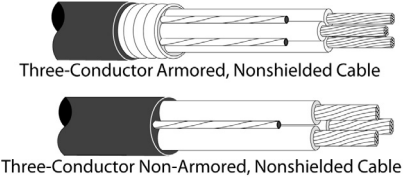
Note: Cable sizes shown below are for standard insulation thickness. Final determining factor is cable insulation O.D.

Voltage	1 kV, 5 kV	 <p>Three-Conductor Armored, Nonshielded Cable</p> <p>Three-Conductor Non-Armored, Nonshielded Cable</p>	
Number of Conductors	Three Conductor		
Shielding Type	Non-Armored (Non-Shielded), Armored (Non-Shielded)		
Splice Type	Inline		
Technology	Cold Shrink, Resin		
Conductor Material	Aluminum, Copper		
RoHS 2011/65/EU	Yes		
Agency Approval	Mine Safety and Health Administrations Acceptance: 07-KA060007-MSHA		

Order No.	UPC	Insulation O.D. Range	1 kV Conductor Size, Copper or Aluminum	5 kV Conductor Size, Copper or Aluminum	Splice Diameter Range*	Typical Splice Length	Case Qty.
5751	051128-59169	0.50"-0.95" (13-24 mm)	1-3/0 AWG (50-95 mm ²)	6-1 AWG (14-50 mm ²)	1.5"-2.5" (38,1-63,5 mm)	19.0" (483 mm)	1
5752	051128-59168	0.66"-1.25" (17-31 mm)	4/0 AWG-350 kcmil (120-185 mm ²)	1/0 AWG-350 kcmil (60-185 mm ²)	2.5"-4.0" (63,5-101,6 mm)	28.0" (711 mm)	1
5753	051128-59171	0.95"-1.80" (24-46 mm)	350-750 kcmil (185-400 mm ²)	350-750 kcmil (185-400 mm ²)	3.5"-6.0" (88,9-152,4 mm)	42.0" (1067 mm)	1

5/8 kV Medium Voltage Splices

The following 3M products cover splicing needs for applications up to 5/8 kV, and promote dependable performance, stability and long life with every splice you make.



Section	Page
5/8 kV	183-189
Non-Shielded	184
Single Conductor (1/C).....	184
3M™ Cold Shrink Inline Non-Shielded Splice Kits 5740 Series	184
Shielded	185-189
Single Conductor (1/C)	185-186
Scotch® Inline and Tee Tape Shielded Cable Splice Kit 5700 Series.....	185
3M™ Cold Shrink Shielded Splice Kits 5550 Series	186
Three Conductor (3/C)	187-189
3M™ Cold Shrink/Armorcast, Armored or Non-Armored Splice Kit 5551-3C-AC.....	187
3M™ Cold Shrink QS-III 3/C Armored or Non-Armored Cable Splice Kits 5775A-MT, 5776A-MT & 5777A-MT for 5/8 kV.....	188
3M™ Cold Shrink MT-C & MT-E Trifurcating Accessory Kits (One 3/C to Three 1/C) for 5/8 kV.....	189
3M™ Cold Shrink 3/C Inline Shielded, Armored or Non-Armored Splice Kits 5760 Series for 5/8 kV.....	189

5/8 kV: Non-Shielded: Single Conductor (1/C)

3M™ Cold Shrink Inline Non-Shielded Splice Kits 5740 Series

The 3M™ Cold Shrink Splicing Products are designed using the proprietary cold shrink delivery system developed by 3M. Products are supplied prestretched on a removable core for efficiency and ease of installation. 3M™ Cold Shrink Splices 5740 Series are used for single conductor, non-shielded 5/8 kV cables.

Each kit is a cold shrink design and contains enough material to insulate three splices. Connectors are not included and must be ordered separately.

Note: Cable sizes shown below are for standard insulation thickness. Final determining factor is cable insulation O.D.

Voltage	5/8 kV
Number of Conductors	Single Conductor
Shielding Type	Non-Shielded (Dry) Cable, Non-Shielded (Wet or Dry) Cable
Splice Type	Inline
Technology	Cold Shrink



Order No.	UPC	Insulation/Jacket O.D. Range	Conductor Size	Max. Connector Length (Cu or Al)	Typical Splice Length	Case Qty.
5741	054007-49491	0.38"-0.70" (9,7-17,8 mm)	8-4 AWG (10-25 mm ²)	2.5" (63,5 mm)	10" (254 mm)	1
5742	054007-49492	0.63"-1.20" (16,0-30,5 mm)	2 AWG-300 kcmil (35-150 mm ²)	4.25" (108,0 mm)	12" (305 mm)	1
5743	054007-49493	0.90"-2.10" (22,9-53,3 mm)	Cu: 350-1000 kcmil (185-500 mm ²) Al: 350-750 kcmil (185-400 mm ²)	6.25" (158,8 mm)	15" (381 mm)	1

5/8 kV: Shielded: Single Conductor (1/C)

Scotch® Inline and Tee Tape Shielded Cable Splice Kit 5700 Series

Scotch® Inline and Tee Tape Shielded Cable Splice Kits 5700 Series handle inline and tee splices on tape shielded, wire shielded or UniShield® cables with copper (Cu) or aluminum (Al) conductors. Kits are rated 5 kV-15 kV, and each kit makes three splices. Use the selector chart to determine the proper kit needed. Connectors and Lugs need to be ordered separately. 3M does not offer tee connectors.

Note: Cable sizes shown below are for standard insulation thickness. Final determining factor is cable insulation O.D.

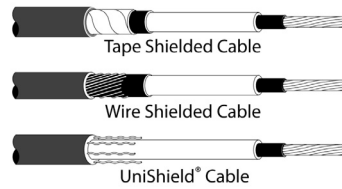

Voltage: 5 kV, 5/8 kV, 15 kV

Number of Conductors: Single Conductor

Shielding Type: Tape Shield, Wire Shield, UniShield®

Splice Type: Inline, Tee

Technology: Tape

Conductor Material: Aluminum, Copper

Product Number	UPC (054007-)	Inline Splices						Tee Splices*						Case Qty.
		5 and 8 kV		15 kV 100% 175mil		15 kV 133% 220 mil		5 and 8 kV		15 kV 100% 175 mil		15 kV 133% 220 mil		
		Cu	Al	Cu	Al	Cu	Al	Cu	Al	Cu	Al	Cu	Al	
Tape Shielded Cable, Wire Shielded Cable, UniShield® Cable See above for cable type illustrations.														
5717	12030	4-250 (22-125)	4-4/0 (2-100)	4-2 (22-30)	—	4	—	—	—	—	—	—	—	1
5718	12048	300-500 (180-250)	250 (150)	1-4/0 (50-100)	4-2/0 (22-60)	2-1/0 (35-60)	—	4-2/0 (22-60)	4-1/0 (22-50)	—	—	—	—	1
5719	12055	550-1000 (300-500)	300-500 (180-250)	250-500 (180-250)	3/0-250 (95-125)	2/0-350 (70-180)	4-3/0 (22-80)	3/0-350 (95-180)	2/0-4/0 (70-100)	4-1 (22-38)	—	—	—	1
5720	12063	—	500-1000 (300-500)	550-1000 (300-500)	300-750 (180-325)	400-750 (240-325)	4/0-500 (120-250)	400-750 (240-325)	250-500 (125-250)	1/0-350 (60-180)	4-4/0 (22-100)	4-250 (22-125)	4-3/0 (22-80)	1

*3M does not offer tee compression connectors.

Note: Larger-numbered kits may be used in place of smaller-numbered kits (with excess materials left over).

Order No.	UPC	Case Qty.
5717	054007-12030	1
5718	054007-12048	1
5719	054007-12055	1
5720	054007-12063	1

5/8 kV: Shielded: Single Conductor (1/C)

3M™ Cold Shrink Shielded Splice Kits 5550 Series

3M™ Cold Shrink Shielded Splice Kit 5550 Series are for splicing 5 kV and 8 kV shielded, solid dielectric, power cables. Meets requirements of IEEE 404. Each kit contains all the materials (except connectors and optional ground strap) required to construct three (3) single conductor splices on Tape Shield, Wire Shield or UniShield® cables.

Note: The kit can also be used to splice a shielded to a non-shielded 5/8 kV cable.

Note: Cable sizes shown below are for standard insulation thickness. Final determining factor is cable insulation O.D.

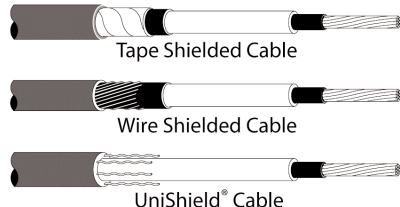
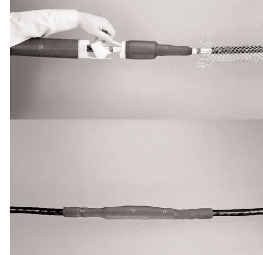
<p>Voltage 5/8 kV</p> <p>Number of Conductors 3 Single Conductors</p> <p>Shielding Type Tape Shield, Wire Shield, UniShield®</p> <p>Splice Type Inline</p> <p>Technology Cold Shrink, Tape</p>	 <p>Tape Shielded Cable</p> <p>Wire Shielded Cable</p> <p>UniShield® Cable</p>	
---	--	---

Order No.	UPC	Conductor Size, Cu	Conductor Size, Al	Max Connector Length, Cu	Max Connector Length, Al	Typical Splice Length	Suggested Accessory	Case Qty.
5551	054007-09089	6-4/0 AWG (14-100 mm ²)	6-3/0 AWG (14-80 mm ²)	3.3" (84 mm)	2.7" (69 mm)	19.0" (482,6 mm)	3M Ground Strap Assembly GS-1	1
5552	054007-09090	4/0 AWG-500 kcmil (120-250 mm ²)	4/0 AWG-400 kcmil (120-200 mm ²)	4.3" (109 mm)	3.7" (94 mm)	21.0" (533,4 mm)	3M Ground Strap Assembly GS-2	1
5553	054007-09091	500-1000 kcmil (300-500 mm ²)	500-1000 kcmil (300-500 mm ²)	6.3" (160 mm)	5.3" (135 mm)	23.0" (584,2 mm)	3M Ground Strap Assembly GS-3	1

5/8 kV: Shielded: Three Conductor (3/C)

3M™ Cold Shrink/Armorcast, Armored or Non-Armored Splice Kit 5551-3C-AC

3M™ Cold Shrink/Armorcast, Armored or Non-Armored Splice Kit 5551-3C-AC is for splicing 3/C, 5/8 kV shielded, armored and non-armored cables. Connectors are not included. Kits include armorcast structural material to reconstitute the cable's armor. Meets the requirements of IEEE 404. Each kit makes one 3/C splice.

Note: Cable sizes shown below are for standard insulation thickness. Final determining factor is cable insulation O.D.

Voltage	5/8 kV
Number of Conductors	Three Conductors
Shielding Type	Shielded Armored or Non-Armored
Splice Type	Inline
Technology	Cold Shrink, Armorcast, Tape



Order No.	UPC	Insulation O.D. Range	Conductor Size	Max. Connector Length	Typical Splice Length	Case Qty.
5551-3C-AC	051128-54317	0.37"-0.78" (9,4-19,8 mm)	Cu: 6-4/0 AWG (14-120 mm ²) Al: 6-3/0 AWG (14-95 mm ²)	2.7" (68,6 mm)	34" (864 mm)	1

5/8 kV: Shielded: Three Conductor (3/C)

3M™ Cold Shrink QS-III 3/C Armored or Non-Armored Cable Splice Kits 5775A-MT, 5776A-MT & 5777A-MT for 5/8 kV

3M™ Cold Shrink QS-III 3/C Armored or Non-Armored Cable Splices 5775A-MT, 5776A-MT and 5777A-MT Series are designed for splicing 3-conductor, armored and non-armored, shielded power cables. The kits are rated for use on 5/8 kV cables with conductor sizes from 3/0 AWG-1000 kcmil (95-500 mm²) or 15 kV cables with conductor sizes from 2 AWG-750 kcmil (35-325 mm²). The kits are designed to be used with 3M™ Scotchlok™ Connectors 10000 and 20000 Series or other UL listed inline compression connectors that fit within the dimension limits listed in the data sheet. Meets the requirements of IEEE-404.

Kits include material necessary to make one 3/C splice. Connectors are not included and must be ordered separately. The completed splice is designed for use in cable trays, weather exposed or direct burial locations.

The splice utilizes several technologies to accommodate the various functions of a 3/C shielded power cable: 3M™ Cold Shrink QS-III Splice Bodies, Scotch® Tapes for moisture sealing, Constant Force Springs for connecting ground braid jumpers and armorcast for replacing the cable armor and/or jacket.

Note: When making a trifurcating splice, the 3M™ Cold Shrink MT-C or MT-E Trifurcating Accessory Kit must be used along with the splice kit.

Note: Cable sizes shown below are for standard insulation thickness. Final determining factor is cable insulation O.D.

Voltage	5/8 kV, 15 kV
Number of Conductors	Three Conductors
Shielding Type	Shielded Armored or Non-Armored
Splice Type	Inline, Trifurcating
Technology	Cold Shrink, Armorcast



Three-Conductor Armored, Shielded Cable



Three-Conductor Non-Armored, Shielded Cable

Order No.	UPC	Insulation O.D. Range	Conductor Size, 5/8 kV	Typical Splice Length	Suggested Accessory	Case Qty.
5775A-MT	051128-53493	0.64"-1.01" (16,3-25,7 mm)	3/0 AWG-250 kcmil (95-125 mm ²)	52.0" (1320,8 mm)	3M™ Trifurcating Accessory for 3-C to 3 Single Conductors MT-C	1
5776A-MT	054007-44112	0.84"-1.38" (21,3-35,1 mm)	350-500 kcmil (185-240 mm ²)	54.0" (1371,6 mm)	3M™ Trifurcating Accessory for 3-C to 3 Single Conductors MT-C; or 3M™ Trifurcating Accessory for 3-C to 3 Single Conductors MT-E	1
5777A-MT	054007-44289	1.04"-1.70" (26,4-43,2 mm)	750-1000 kcmil (325-500 mm ²)	58.0" (1473,2 mm)	3M™ Trifurcating Accessory for 3-C to 3 Single Conductors MT-E	1

5/8 kV: Shielded: Three Conductor (3/C)

3M™ Cold Shrink MT-C & MT-E Trifurcating Accessory Kits (One 3/C to Three 1/C) for 5/8 kV

3M™ Cold Shrink MT-C and MT-E Trifurcating Accessory Kits are used to break out and seal a transition from 3/C to three 1/C.

For use with 3M™ Cold Shrink QS-III Splicing Series 5700A-MT.

NOTE: Cable sizes shown below are for standard insulation thickness. Final determining factor is cable insulation O.D.

Voltage: 5/8 kV

Number of Conductors: One 3/C to three 1/C



Selection Table

3M™ Splice 57XXA-MT	5/8 kV (90/140 mil)	Appropriate MT Transition Kit
*Typical Conductor Size Range – AWG/kcmil		
5775A-MT	3/0-250	MT-C
5776A-MT	350	MT-C
5776A-MT	500	MT-E
5777A-MT	—	MT-E

Order No.	UPC	Single Conductor Jacket O.D.	Kits per Case
MT-C	051128-55208	0.62"-1.13" (15,7-28,7 mm)	1
MT-E	051128-54318	1.13"-1.80" (28,7-45,7 mm)	1

3M™ Cold Shrink 3/C Inline Shielded, Armored or Non-Armored Splice Kits 5760 Series for 5/8 kV

These splice kits are designed for splicing shielded armored and non-armored cables, 5/8 kV and 15 kV. Each kit makes one 3/C splice. Connectors are not included and must be ordered separately.

Note: Cable sizes shown below are for standard insulation thickness. Final determining factor is cable insulation O.D.

Voltage	5/8 kV, 15 kV
Number of Conductors	Three Conductors
Shielding Type	Shielded Armored or Non-Armored
Splice Type	Inline
Technology	Cold Shrink, Resin
RoHS 2011/65/EU	Yes



Order No.	UPC	Insulation O.D. Range	Conductor Size, 5/8 kV	Max. Connector O.D.	Max. Connector Length	Typical Splice Length	Case Qty.
5761	051128-59172	0.65"-1.00" (16,5-25,4 mm)	2/0 AWG-350 kcmil (60-150 mm²)	0.90" (22,9 mm)	2.75" (69,9 mm)	29.0" (737 mm)	1
5762	051128-59170	0.93"-1.94" (23,6-49,3 mm)	500-1000 kcmil (300-500 mm²)	1.40" (35,5 mm)	5.00" (127,0 mm)	44.0" (1118 mm)	1

15 kV Medium Voltage Splices

The following 3M products cover splicing needs for applications up to 15 kV, and promote dependable performance, stability and long life with every splice you make.



Section	Page
15 kV	190-209
3M™ Cold Shrink Splice Kits.....	191-196
Single Conductor (1/C)	191-194
Inline.....	191-194
3M™ Cold Shrink QS-III Inline CN/JCN Splice Kits 5415A, 5416A, 5417A and 5418A Series.....	191-192
3M™ Cold Shrink QS-III Inline Shielded Cable Splice Kits 5513A, 5514A, 5515A and 5516A Series.....	193-194
Branch.....	194
3M™ Cold Shrink Branch Splice Kit QS-2001B and 3M™ Cold Shrink Branch Splice Adapter QS-2000BA	194
Three Conductor (3/C)	195-196
3M™ Cold Shrink QS-III 3/C Armored or Non-Armored Cable Splice Kits 5775A-MT, 5776A-MT & 5777A-MT for 15 kV.....	195
3M™ Cold Shrink MT-C & MT-E Trifurcating Accessory Kits (One 3/C to Three 1/C) for 15 kV.....	196
3M™ Cold Shrink 3/C Inline Shielded, Armored or Non-Armored Splice Kits 5760 Series for 15 kV	196
3M™ Molded Rubber Splice Kits.....	197-202
Single Conductor (1/C)	197-202
3M™ Molded Rubber QS-II Inline JCN/CN Splice Kits 5411, 5411A and 5412 Series	197
3M™ Molded Rubber QS Inline JCN/CN Splice Kits 5400 Series	198
3M™ Molded Rubber QS-II JCN/CN Cable Repair Splice Kits 5411R and 5412R Series.....	199
3M™ Molded Rubber QS-II Inline Shielded Cable Splice Kits 5500 Series	200
3M™ Aluminum Repair Connectors CIR Series for 3M™ Rubber Splices 5411R & 5412R Series.....	201
3M™ Connectors CI Series for 3M™ Rubber Splices 5400 & 5500 Series.....	201
3M™ Connectors CI Series for 3M™ Rubber Splices 5411, 5411A, 5412 & 5500 Series.....	202
3M™ Aluminum Transition Connectors CI-T Series for 5411 & 5500 Series	202
3M™ PILC Splice Kits	203-208
Single Conductor (1/C)	203-204
3M™ Cold Shrink QS-III 1/C Inline Transition Splice Kits 5510A-1T-PILC Series	203
3M™ Cold Shrink Splice Kits QS-2000T 1/C PILC to 1/C Poly/EPR or 1/C PILC to 1/C PILC Cable Splices	204
Three Conductor (3/C)	205-208
3M™ Cold Shrink Splice Kits QS-2000-3T and QS-2000-3T-WS 3/C PILC to 1/C Poly/EPR Cable Trifurcating Splices.....	205
3M™ Cold Shrink 3/C PILC to 3/C Poly/EPR Cable Transition Splice Kit QS-2013-3T-3C.....	206
3M™ Scotchlok™ Connectors 2000T-CU for 15 kV.....	207
3M™ Scotchlok™ Reducer Series Connectors 2000T-CU/AL for 15 kV	208
3M™ Tape Splice Kits.....	209
Single Conductor (1/C).....	209
Scotch® Inline and Tee Tape Shielded Cable Splice Kits 5700 Series	209

15 kV: 3M™ Cold Shrink Splice Kits: Single Conductor (1/C): Inline

3M™ Cold Shrink QS-III Inline CN/JCN Splice Kits 5415A, 5416A, 5417A and 5418A Series

The 3M™ Cold Shrink QS-III Inline CN/JCN Splice Kits 5415A, 5416A, 5417A, 5417A-WG, 5418A and 5418A-WG Series are 15 kV class inline splices for joining jacketed concentric neutral (JCN) and concentric neutral (CN) power cables. They are a cold shrink design sized to fit Type MV-90 or Type MV-105 cables with copper, or aluminum conductor sizes ranging from 2 AWG-1000 kcmil (35-500 mm²). The cold shrink splice body is a one-piece molded design made of specially formulated silicone rubbers, while the cold shrink jacketing is made of EPDM rubber for physical protection. Each splice manufactured is factory tested to provide reliability.

The splices can be used with standard copper (Cu) or aluminum (Al/Cu) inline compression (crimp type) connectors as well as shearbolt connectors, and can be used for size transitions within the listed kit size range. They are designed to exceed minimum industry test standards, and have a BIL rating of 150 kV (equal to a 25 kV voltage class). The 3M™ Cold Shrink QS-III Splice Kits 5415A, 5416A, 5417A, 5417A-WG, 5418A and 5418A-WG meet or exceed the 15 kV Voltage Class rating requirements of IEEE-404. Kit contents include sufficient materials to make one splice.

Note: 5417A-WG and 5418A-WG are partially jacketed splices containing built-in bleeder wires. Additional end user materials are required to convert to full jacketing.

Note: Cable sizes shown below are for standard insulation thickness. Final determining factor is cable insulation O.D.

Voltage	15 kV
Number of Conductors	Single Conductor
Shielding Type	Concentric Neutral (CN), Jacketed Concentric Neutral (JCN)
Splice Type	Inline
Technology	Cold Shrink



Order No.	UPC	Insulation O.D. Range	Conductor Size	Connector Included	Case Qty.
5415A	051128-53470	0.64"-1.01" (16,3-25,7 mm)	2-4/0 AWG (35-95 mm ²)	-	1
5415A-2-AL	051128-53471	0.64"-1.01" (16,3-25,7 mm)	2 AWG	20003	1
5415A-2-CU	051128-53472	0.64"-1.01" (16,3-25,7 mm)	2 AWG	10003	1
5415A-1-AL	051128-53473	0.64"-1.01" (16,3-25,7 mm)	1 AWG	20004	1
5415A-1-CU	051128-53474	0.64"-1.01" (16,3-25,7 mm)	1 AWG	10004	1
5415A-1/0-AL	051128-53475	0.64"-1.01" (16,3-25,7 mm)	1/0 AWG	20005	1
5415A-1/0-CU	051128-53476	0.64"-1.01" (16,3-25,7 mm)	1/0 AWG	10005	1
5415A-2/0-AL	051128-53477	0.64"-1.01" (16,3-25,7 mm)	2/0 AWG	20006	1
5415A-2/0-CU	051128-53478	0.64"-1.01" (16,3-25,7 mm)	2/0 AWG	10006	1
5415A-3/0-AL	051128-53747	0.64"-1.01" (16,3-25,7 mm)	3/0 AWG	20007	1
5415A-3/0-CU	051128-53748	0.64"-1.01" (16,3-25,7 mm)	3/0 AWG	10007	1
5415A-4/0-AL	051128-53749	0.64"-1.01" (16,3-25,7 mm)	4/0 AWG	20008	1
5415A-4/0-CU	051128-53750	0.64"-1.01" (16,3-25,7 mm)	4/0 AWG	10008	1
5416A	054007-44092	0.84"-1.38" (21,3-35,1 mm)	4/0 AWG-350 kcmil (95-185 mm ²)	-	1
5416A-4/0-AL	054007-44093	0.84"-1.38" (21,3-35,1 mm)	4/0 AWG	20008	1
5416A-4/0-CU	054007-44094	0.84"-1.38" (21,3-35,1 mm)	4/0 AWG	10008	1
5416A-250-AL	054007-44096	0.84"-1.38" (21,3-35,1 mm)	250 kcmil	20009	1
5416A-250-CU	054007-44097	0.84"-1.38" (21,3-35,1 mm)	250 kcmil	10009	1
5416A-350-AL	054007-44098	0.84"-1.38" (21,3-35,1 mm)	350 kcmil	20011	1
5416A-350-CU	054007-44099	0.84"-1.38" (21,3-35,1 mm)	350 kcmil	10011	1

3M™ Cold Shrink QS-III Inline CN/JCN Splice Kits 5415A, 5416A, 5417A and 5418A Series (continued)

Order No.	UPC	Insulation O.D. Range	Conductor Size	Connector Included	Case Qty.
5417A	054007-42124	1.04"-1.70" (26,4-43,2 mm)	350-750 kcmil (185-325 mm ²)	-	1
5417A-350-AL	054007-42125	1.04"-1.70" (26,4-43,2 mm)	350 kcmil	20011	1
5417A-350-CU	054007-44234	1.04"-1.70" (26,4-43,2 mm)	350 kcmil	10011	1
5417A-500-AL	054007-42126	1.04"-1.70" (26,4-43,2 mm)	500 kcmil	20014	1
5417A-500-CU	054007-44235	1.04"-1.70" (26,4-43,2 mm)	500 kcmil	10014	1
5417A-750-AL	054007-04587	1.04"-1.70" (26,4-43,2 mm)	750 kcmil	20019	1
5417A-750-CU	054007-04588	1.04"-1.70" (26,4-43,2 mm)	750 kcmil	10019	1
5417A-WG	054007-44090	1.04"-1.70" (26,4-43,2 mm)	350-750 kcmil (185-325 mm ²)	-	1
5418A	054007-42128	1.08"-1.70" (27,4-43,2 mm)	500-1000 kcmil (240-500 mm ²)	-	1
5418A-500-AL	054007-44403	1.08"-1.70" (27,4-43,2 mm)	500 kcmil	20014	1
5418A-500-CU	054007-44404	1.08"-1.70" (27,4-43,2 mm)	500 kcmil	10014	1
5418A-750-AL	054007-42129	1.08"-1.70" (27,4-43,2 mm)	750 kcmil	20019	1
5418A-750-CU	054007-44236	1.08"-1.70" (27,4-43,2 mm)	750 kcmil	10019	1
5418A-1000-AL	054007-42130	1.08"-1.70" (27,4-43,2 mm)	1000 kcmil	20024	1
5418A-1000-CU	054007-44237	1.08"-1.70" (27,4-43,2 mm)	1000 kcmil	10024	1
5418A-WG	054007-44091	1.08"-1.70" (27,4-43,2 mm)	500-1000 kcmil (240-500 mm ²)	-	1

3M™ Cold Shrink QS-III Inline Shielded Cable Splice Kits 5513A, 5514A, 5515A and 5516A Series

The 3M™ Cold Shrink QS-III Shielded Cable Splices 5513A, 5514A, 5515A and 5516A Series are 15 kV class inline splices for joining tape shield, wire shield, UniShield® or longitudinally corrugated (LC) shielded power cables. It is a cold shrink design sized to fit Type MV-90 or Type MV-105 cables with copper, or aluminum conductor sizes ranging from 2 AWG-1000 kcmil (35-500 mm²). The cold shrink splice body is a one-piece molded design made of special formulated silicone rubbers, while the cold shrink jacketing is made of EPDM rubber for physical protection. Each splice manufactured is factory tested to provide reliability.

The splices can be used with standard copper (Cu) or aluminum (Al/Cu) inline compression (crimp type) connectors, and can be used for size transitions within the listed kit size range. They are designed to exceed minimum industry test standards, and have a BIL rating of 150 kV (equal to a 25 kV voltage class). The 5513A, 5514A, 5515A and 5516A QS-III splices meet or exceed the 15 kV Voltage Class rating requirements of IEEE 404. Each kit makes one splice.

Note: Cable sizes shown below are for standard insulation thickness. Final determining factor is cable insulation O.D.

Voltage	15 kV	
Number of Conductors	Single Conductor	
Shielding Type	Tape Shield, Wire Shield, UniShield®, Longitudinally Corrugated (LC) Shield	
Splice Type	Inline	
Technology	Cold Shrink	

Order No.	UPC	Insulation O.D. Range	Conductor Size	Connector Included	Case Qty.
5513A	051128-53480	0.64"-1.01" (16,3-25,7 mm)	2-4/0 AWG	-	1
5513A-2-AL	051128-53481	0.64"-1.01" (16,3-25,7 mm)	2 AWG	20003	1
5513A-2-CU	051128-53482	0.64"-1.01" (16,3-25,7 mm)	2 AWG	10003	1
5513A-1-AL	051128-53483	0.64"-1.01" (16,3-25,7 mm)	1 AWG	20004	1
5513A-1-CU	051128-53484	0.64"-1.01" (16,3-25,7 mm)	1 AWG	10004	1
5513A-1/0-AL	051128-53485	0.64"-1.01" (16,3-25,7 mm)	1/0 AWG	20005	1
5513A-1/0-CU	051128-53486	0.64"-1.01" (16,3-25,7 mm)	1/0 AWG	10005	1
5513A-2/0-AL	051128-53487	0.64"-1.01" (16,3-25,7 mm)	2/0 AWG	20006	1
5513A-2/0-CU	051128-53488	0.64"-1.01" (16,3-25,7 mm)	2/0 AWG	10006	1
5513A-3/0-AL	051128-53489	0.64"-1.01" (16,3-25,7 mm)	3/0 AWG	20007	1
5513A-3/0-CU	051128-53490	0.64"-1.01" (16,3-25,7 mm)	3/0 AWG	10007	1
5513A-4/0-AL	051128-53491	0.64"-1.01" (16,3-25,7 mm)	4/0 AWG	20008	1
5513A-4/0-CU	051128-53492	0.64"-1.01" (16,3-25,7 mm)	4/0 AWG	10008	1
5514A	054007-44101	0.84"-1.38" (21,3-35,1 mm)	4/0 AWG-500 kcmil	-	1
5514A-CA-1	051128-57151	0.64"-1.38" (16,3-35,1 mm)	2 AWG-500 kcmil	-	1
5514A-4/0-AL	054007-44102	0.84"-1.38" (21,3-35,1 mm)	4/0 AWG	20008	1
5514A-4/0-CU	054007-44103	0.84"-1.38" (21,3-35,1 mm)	4/0 AWG	10008	1
5514A-250-AL	054007-44104	0.84"-1.38" (21,3-35,1 mm)	250 kcmil	20009	1
5514A-250-CU	054007-44105	0.84"-1.38" (21,3-35,1 mm)	250 kcmil	10009	1
5514A-350-AL	054007-44106	0.84"-1.38" (21,3-35,1 mm)	350 kcmil	20011	1
5514A-350-CU	054007-44107	0.84"-1.38" (21,3-35,1 mm)	350 kcmil	10011	1
5514A-500-AL	054007-44407	0.84"-1.38" (21,3-35,1 mm)	500 kcmil	20014	1
5514A-500-CU	054007-44408	0.84"-1.38" (21,3-35,1 mm)	500 kcmil	10014	1
5515A	054007-42134	1.04"-1.70" (26,4-43,2 mm)	350-750 kcmil	-	1
5515A-350-AL	054007-42135	1.04"-1.70" (26,4-43,2 mm)	350 kcmil	20011	1
5515A-350-CU	054007-42898	1.04"-1.70" (26,4-43,2 mm)	350 kcmil	10011	1
5515A-500-AL	054007-42899	1.04"-1.70" (26,4-43,2 mm)	500 kcmil	20014	1
5515A-500-CU	054007-42136	1.04"-1.70" (26,4-43,2 mm)	500 kcmil	10014	1
5515A-750-AL	054007-42900	1.04"-1.70" (26,4-43,2 mm)	750 kcmil	20019	1

15 kV: 3M™ Cold Shrink Splice Kits: Single Conductor (1/C): Inline

3M™ Cold Shrink QS-III Inline Shielded Cable Splice Kits 5513A, 5514A, 5515A and 5516A Series (continued)

Order No.	UPC	Insulation O.D. Range	Conductor Size	Connector Included	Case Qty.
5515A-750-CU	054007-42137	1.04"-1.70" (26,4-43,2 mm)	750 kcmil	10019	1
5516A	054007-42139	1.08"-1.70" (27,4-43,2 mm)	500-1000 kcmil	–	1
5516A-500-AL	054007-44405	1.08"-1.70" (27,4-43,2 mm)	500 kcmil	20014	1
5516A-500-CU	054007-44406	1.08"-1.70" (27,4-43,2 mm)	500 kcmil	10014	1
5516A-750-AL	054007-43254	1.08"-1.70" (27,4-43,2 mm)	750 kcmil	20019	1
5516A-750-CU	054007-43255	1.08"-1.70" (27,4-43,2 mm)	750 kcmil	10019	1
5516A-1000-AL	054007-42901	1.08"-1.70" (27,4-43,2 mm)	1000 kcmil	20024	1
5516A-1000-CU	054007-42106	1.08"-1.70" (27,4-43,2 mm)	1000 kcmil	10024	1

15 kV: 3M™ Cold Shrink Splice Kits: Single Conductor (1/C): Branch

3M™ Cold Shrink Branch Splice Kit QS-2001B and 3M™ Cold Shrink Branch Splice Adapter QS-2000BA

The 3M™ Cold Shrink Branch Splice QS-2001B molded rubber splice kit is designed to connect extruded dielectric power cables rated 15 kV. The basic kit handles the main and branch cable range from 350–500 kcmil. (See note below for cable between 2 AWG-250 kcmil.) This kit utilizes the QS-2000 cold shrink technology and consists of a multi-layer silicone rubber splice and stress control body, each expanded on a removable, supporting polymeric core. Kits contain sufficient material to make one branch splice.

Note: For 2 AWG-250 kcmil cable, the 3M™ Cold Shrink Branch Splice Adapter QS-2000BA must be ordered and used in conjunction with the 3M™ Cold Shrink Branch Splice Kit QS-2001B. The adapter kit will increase the cable insulation O.D. so that the cable will work with the splice body. Order one adapter kit for each cable end (3 maximum/splice) below 350 kcmil (185 mm²) conductor size.

Note: Cable sizes shown below are for standard insulation thickness. Final determining factor is cable insulation O.D.

Voltage	15 kV
Number of Conductors	Single Conductor Branch Splice
Shielding Type	Concentric Neutral (CN), Jacketed Concentric Neutral (JCN), Tape Shield, UniShield®, Wire Shield
Technology	Cold Shrink

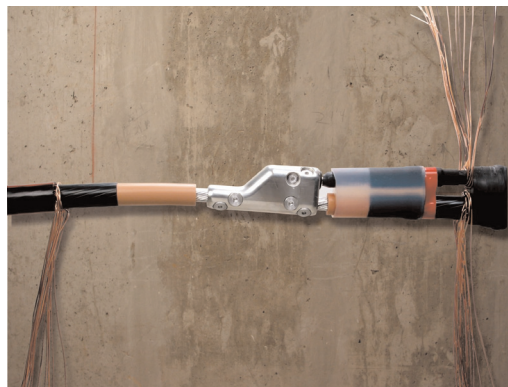

Order No.	UPC	Insulation O.D. Range	Conductor Size	Product Type	Suggested Accessory	Case Qty.
QS2001B	051128-55254	1.00"-1.35" (25,4-34,3 mm); or 0.64"-1.01" (16,2-25,6 mm) with QS-2000BA Adapter Kit	2 AWG-500 kcmil (35-240 mm ²) Must use QS-2000BA Adapter Kit for 2 AWG-250 kcmil (35-150 mm ²)	Splice	3M™ Cold Shrink Branch Splice Adapter Kit QS-2000BA	1
QS2000B-A	051128-55255	N/A	N/A	Accessory	N/A	1

15 kV: 3M™ Cold Shrink Splice Kits: Three Conductor (3/C)

3M™ Cold Shrink QS-III 3/C Armored or Non-Armored Cable Splice Kits 5775A-MT, 5776A-MT & 5777A-MT for 15 kV

3M™ Cold Shrink QS-III 3/C Armored or Non-Armored Cable Splices 5775A-MT, 5776A-MT and 5777A-MT Series are designed for splicing 3-conductor, armored and non-armored, shielded power cables. The kits are rated for use on 5/8 kV cables with conductor sizes from 3/0 AWG-1000 kcmil (95-500 mm²) or 15 kV cables with conductor sizes from 2 AWG-750 kcmil (35-325 mm²). The kits are designed to be used with 3M™ Scotchlok™ Connectors 10000 and 20000 Series or other UL listed inline compression connectors that fit within the dimension limits listed in the data sheet. Meets the requirements of IEEE-404.

Kits include material necessary to make one 3/C splice. Connectors are not included and must be ordered separately. The completed splice is designed for use in cable trays, weather exposed or direct burial locations.

The splice utilizes several technologies to accommodate the various functions of a 3/C shielded power cable: 3M™ Cold Shrink QS-III Splice Bodies, Scotch® Tapes for moisture sealing, Constant Force Springs for connecting ground braid jumpers and armorcast for replacing the cable armor and/or jacket.

Note: When making a trifurcating splice, the 3M™ Cold Shrink MT-C or MT-E Trifurcating Accessory Kit must be used along with the splice kit.

Note: Cable sizes shown below are for standard insulation thickness. Final determining factor is cable insulation O.D.

Voltage	5/8 kV, 15 kV
Number of Conductors	Three Conductors
Shielding Type	Shielded Armored or Non-Armored
Splice Type	Inline, Trifurcating
Technology	Cold Shrink, Armorcast



Order No.	UPC	Insulation O.D. Range	Conductor Size, 15 kV	Typical Splice Length	Suggested Accessory	Case Qty.
5775A-MT	051128-53493	0.64"-1.01" (16,3-25,7 mm)	2-4/0 AWG (35-95 mm ²)	52.0" (1320,8 mm)	3M™ Trifurcating Accessory for 3-C to 3 Single Conductors MT-C	1
5776A-MT	054007-44112	0.84"-1.38" (21,3-35,1 mm)	4/0 AWG-500 kcmil (95-240 mm ²)	54.0" (1371,6 mm)	3M™ Trifurcating Accessory for 3-C to 3 Single Conductors MT-C; or 3M™ Trifurcating Accessory for 3-C to 3 Single Conductors MT-E	1
5777A-MT	054007-44289	1.04"-1.70" (26,4-43,2 mm)	350-750 kcmil (185-325 mm ²)	58.0" (1473,2 mm)	3M™ Trifurcating Accessory for 3-C to 3 Single Conductors MT-E	1

15 kV: 3M™ Cold Shrink Splice Kits: Three Conductor (3/C)

3M™ Cold Shrink MT-C & MT-E Trifurcating Accessory Kits (One 3/C to Three 1/C) for 15 kV

3M™ Cold Shrink MT-C and MT-E Trifurcating Accessory Kits are used to break out and seal a transition from 3/C to three 1/C.

For use with 3M™ Cold Shrink QS-III Splicing Series 5700A-MT.

Note: Cable sizes shown below are for standard insulation thickness. Final determining factor is cable insulation O.D.

Voltage: 15 kV

Number of Conductors: One 3/C to three 1/C



Selection Table

3M™ Splice 57XXA-MT	15 kV (175/220 mil)	Appropriate MT Transition Kit
Typical Conductor Size Range – AWG/kcmil		
5775A-MT	2-4/0	MT-C
5776A-MT	4/0-250	MT-C
5776A-MT	350-500	MT-E

Order No.	UPC	Single Conductor Jacket O.D.	Kits per Case
MT-C	051128-55208	0.62"-1.13" (15,7-28,7 mm)	1
MT-E	051128-54318	1.13"-1.80" (28,7-45,7 mm)	1

3M™ Cold Shrink 3/C Inline Shielded, Armored or Non-Armored Splice Kits 5760 Series for 15 kV

These splice kits are designed for splicing shielded armored and non-armored cables, 5/8 kV and 15 kV. Each kit makes one 3/C splice. Connectors are not included and must be ordered separately.

Note: Cable sizes shown below are for standard insulation thickness. Final determining factor is cable insulation O.D.

Voltage	5/8 kV, 15 kV
Number of Conductors	Three Conductors
Shielding Type	Shielded Armored or Non-Armored
Splice Type	Inline
Technology	Cold Shrink, Resin
RoHS 2011/65/EU	Yes

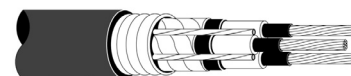

Three-Conductor Armored, Shielded Cable



Three-Conductor Non-Armored, Shielded Cable



Order No.	UPC	Insulation O.D. Range	Conductor Size, 15 kV	Max. Connector O.D.	Max. Connector Length	Typical Splice Length	Case Qty.
5761	051128-59172	0.65"-1.00" (16,5-25,4 mm)	2-3/0 AWG (35-80 mm ²)	0.90" (22,9 mm)	2.75" (69,9 mm)	29.0" (737 mm)	1
5762	051128-59170	0.93"-1.94" (23,6-49,3 mm)	Cu: 4/0 AWG-750 kcmil (120-325 mm ²) Al: 4/0 AWG-500 kcmil (120-250 mm ²)	1.40" (35,5 mm)	5.00" (127,0 mm)	44.0" (1118 mm)	1

15 kV: 3M™ Molded Rubber Splice Kits: Single Conductor (1/C)

3M™ Molded Rubber QS-II Inline JCN/CN Splice Kits 5411, 5411A and 5412 Series

3M™ Molded Rubber QS-II Inline JCN/CN Splices 5411, 5411A and 5412 Series are one-piece inline splices designed for use on 15 kV rated CN and JCN cable. Meets the requirements of IEEE 404. Splice can be ordered with the special CI-Series connector packed in the kit, or the kit and connector can be ordered as separate items.

Note: Cable sizes shown below are for standard insulation thickness. Final determining factor is cable insulation O.D.

Voltage	15 kV
Number of Conductors	Single Conductor
Shielding Type	Concentric Neutral (CN), Jacketed Concentric Neutral (JCN)
Splice Type	Inline
Technology	Molded Rubber

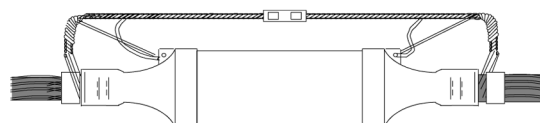
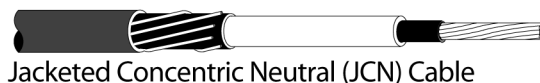
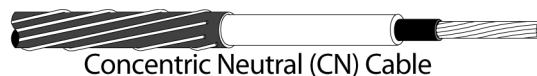

Order No.	UPC	Insulation O.D. Range	Conductor Size, Stranded	Conductor Size, Solid	Connector Included	Case Qty.
5411	054007-11852	0.637"-0.900" (16,2-22,9 mm)	4 - 2/0 AWG (175 mil)	2-1/0 AWG	-	1
5411-CI-1/0	054007-11855	0.637"-0.900" (16,2-22,9 mm)	1/0 AWG	-	CI-1/0	1
5411-CI-2	054007-08005	0.637"-0.900" (16,2-22,9 mm)	2 AWG	1 AWG	CI-2	1
5411-CI-21	054007-11853	0.637"-0.900" (16,2-22,9 mm)	2 AWG, 1 AWG	1 AWG, 1/0 AWG	CI-21	1
5411-CI-22	054007-11854	0.637"-0.900" (16,2-22,9 mm)	4 AWG (220 mil)	2 AWG	CI-22	1
5411-20006	054007-11861	0.637"-0.900" (16,2-22,9 mm)	2/0 AWG (175 mil)	-	20006	1
5411A	054007-09937	0.775"-0.900" (19,7-22,9 mm)	1 AWG (220 mil) 1/0 AWG (220 mil) 2/0 AWG (175 mil)	1/0 AWG (220 mil)	-	1
5411A-CI-1	054007-09938	0.775"-0.900" (19,7-22,9 mm)	1 AWG (220 mil)	1/0 AWG (220 mil)	CI-1	1
5411A-CI-1/0	054007-09939	0.775"-0.900" (19,7-22,9 mm)	1/0 AWG (220 mil)	-	CI-1/0	1
5411A-20006	054007-09940	0.775"-0.900" (19,7-22,9 mm)	2/0 AWG (175 mil)	-	20006	1
5412	054007-11862	0.840"-1.050" (21,3-26,7 mm)	2/0 AWG (220 mil) 3/0-4/0 AWG 250 kcmil (175 mil)	-	-	1
5412-CI-2/0	054007-11865	0.840"-1.050" (21,3-26,7 mm)	2/0 AWG (220 mil)	-	CI-2/0	1
5412-CI-3/0	054007-11863	0.840"-1.050" (21,3-26,7 mm)	3/0 AWG	-	CI-3/0	1
5412-CI-4/0	054007-11864	0.840"-1.050" (21,3-26,7 mm)	4/0 AWG	-	CI-4/0	1

15 kV: 3M™ Molded Rubber Splice Kits: Single Conductor (1/C)

3M™ Molded Rubber QS Inline JCN/CN Splice Kits 5400 Series

3M™ Molded Rubber QS Inline JCN/CN Splice Kits 5400 Series are inline splices designed for use on 15 kV concentric neutral (CN) or jacketed concentric neutral (JCN) cable. The continuous current rating of each splice is equal to the current rating of the cable it is sized to accommodate. Meets requirements of IEEE 404 for cable joints. Jacketing kit is needed for JCN cable.

Each kit makes one splice. Connectors, unless specified, are not included in the kit, and must be ordered separately.

Note: Cable sizes shown below are for standard insulation thickness. Final determining factor is cable insulation O.D.

Voltage	15 kV
Number of Conductors	Single Conductor
Splice Type	Inline
Shielding Type	Concentric Neutral (CN), Jacketed Concentric Neutral (JCN)
Technology	Molded Rubber

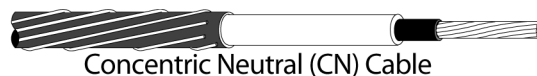

Concentric Neutral (CN) Cable



Jacketed Concentric Neutral (JCN) Cable

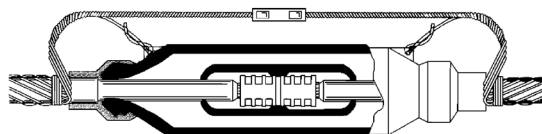

Order No.	UPC	Insulation O.D. Range	Conductor Size, Stranded	Connector Included	Case Qty.
5403	054007-11818	0.795"-0.940" (20,2-23,9 mm)	2/0-4/0 AWG	—	1
5404	054007-11826	0.920"-1.080" (23,4-27,4 mm)	2/0-4/0 AWG	—	1
5405	054007-11834	0.920"-1.080" (23,4-27,4 mm)	250-350 kcmil	—	1
5406	054007-11842	1.060"-1.210" (26,9-30,7 mm)	250 (220 mil)-350 kcmil	—	1
5406-CI-350	054007-41907	1.060"-1.210" (26,9-30,7 mm)	350 kcmil	CI-350	1
5407	054007-25602	1.120"-1.320" (28,5-33,5 mm)	500 kcmil	—	1
5407-CI-500	054007-02315	1.120"-1.320" (28,5-33,5 mm)	500 kcmil	CI-500	1
5408	054007-25610	1.320"-1.520" (33,5-38,6 mm)	750 kcmil	—	1
5408-CI-750	054007-02314	1.320"-1.520" (33,5-38,6 mm)	750 kcmil	CI-750	1
5408-CCI-750	054007-41709	1.320"-1.520" (33,5-38,6 mm)	750 kcmil	CCI-750	1
5409	054007-11859	1.490"-1.660" (37,8-42,2 mm)	750 kcmil	—	1
5409-CI-750	054007-30209	1.490"-1.660" (37,8-42,2 mm)	750 kcmil	CI-750	1

3M™ Molded Rubber QS-II JCN/CN Cable Repair Splice Kits 5411R and 5412R Series

3M™ Molded Rubber QS-II JCN/CN Cable Repair Splice Kit 5411R and 5412R Series are specially elongated molded rubber splices designed to repair damaged cable. They can be used on 15 kV copper or aluminum, CN or JCN cables. It is designed to replace up to 6" (152 mm) of damaged cable, thus virtually eliminating the need to splice in a new section of cable with two separate splices.

Meets the requirements of IEEE 404. The 5411R/5412R can be ordered with the special CIR-Series connector packed in the kit or the kit and connector can be ordered as separate items. Each kit makes one repair splice.

Note: Cable sizes shown below are for standard insulation thickness. Final determining factor is cable insulation O.D.

Voltage	15 kV
Number of Conductors	Single Conductor
Shielding Type	Concentric Neutral (CN), Jacketed Concentric Neutral (JCN)
Splice Type	Inline Repair
Technology	Molded Rubber

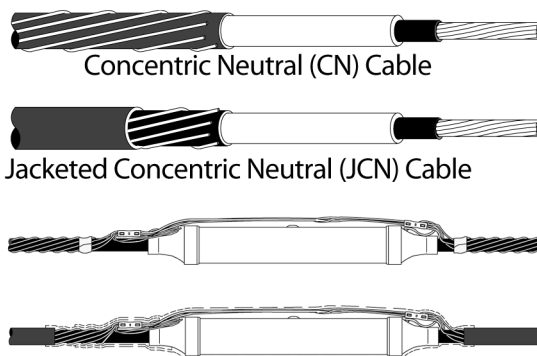

Order No.	UPC	Insulation O.D. Range	Conductor Size, Stranded	Conductor Size, Solid	Connector Included	Case Qty.
5411R	054007-09352	0.637"-0.900" (16,3-22,9 mm)	4 AWG (220 mil only); 2-1/0 AWG	2-1/0 AWG	-	1
5411R-CIR-2	051128-55097	0.637"-0.900" (16,3-22,9 mm)	2 AWG	-	CIR-2	1
5411R-CIR-1/0	054007-09355	0.637"-0.900" (16,3-22,9 mm)	1/0 AWG	-	CIR-1/0	1
5411R-CIR-1/0-2-10002	054007-44273	0.637"-0.900" (16,3-22,9 mm)	1/0 AWG	-	One CIR-1/0; and Two 10002	1
5411R-CIR-21	054007-09354	0.637"-0.900" (16,3-22,9 mm)	2-1 AWG	1-1/0 AWG	CIR-21	1
5411R-CIR-22	054007-09353	0.637"-0.900" (16,3-22,9 mm)	4 AWG (220 mil only)	2 AWG	CIR-22	1
5412R-CIR-2/0	051128-57179	0.870"-1.055" (22,1-26,9 mm)	2/0 AWG (220 mil)	-	CIR-2/0	1
5412R-CIR-3/0	054007-43501	0.870"-1.055" (22,1-26,9 mm)	3/0 AWG	-	CIR-3/0	1
5412R-CIR-4/0	054007-50101	0.870"-1.055" (22,1-26,9 mm)	4/0 AWG	-	CIR-4/0	1

15 kV: 3M™ Molded Rubber Splice Kits: Single Conductor (1/C)

3M™ Molded Rubber QS-II Inline Shielded Cable Splice Kits 5500 Series

3M™ Molded Rubber QS-II Inline Shielded Cable Splices 5500 Series are inline splices designed for use on 15 kV copper or aluminum Tape Shielded, Wire Shielded and UniShield® cable from 4 AWG-750 kcmil. The continuous current rating of each splice is equal to the current rating of the cable it is sized to accommodate. Meets requirements of IEEE 404.

Each kit makes one splice. A special CI-Series Connector is necessary to complete the splice. Order the connector separately or as part of the kit.

Note: Cable sizes shown below are for standard insulation thickness. Final determining factor is cable insulation O.D.

Voltage	15 kV
Number of Conductors	Single Conductor
Shielding Type	Tape Shield, Wire Shield, UniShield®
Splice Type	Inline
Technology	Molded Rubber

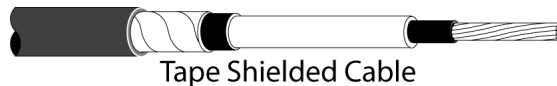

Tape Shielded Cable

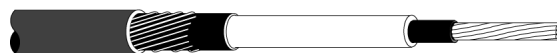

Wire Shielded Cable

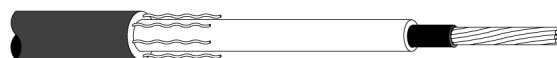

UniShield® Cable

Order No.	UPC	Insulation O.D. Range	Conductor Size, Stranded, Cu or Al	Conductor Size, Solid, Cu or Al	Connector Included	Case Qty.
5501	054007-12293	0.637"-0.900" (16,2-22,9 mm)	4-1/0 AWG 2/0 AWG (175 mil)	2-1/0 AWG	-	1
5501-CI-21	054007-09628	0.637"-0.900" (16,2-22,9 mm)	2-1 AWG	1-1/0 AWG	CI-21	1
5501-CI-1/0	054007-09629	0.637"-0.900" (16,2-22,9 mm)	1/0 AWG	-	CI-1/0	1
5501-20006	054007-09630	0.637"-0.900" (16,2-22,9 mm)	2/0 AWG (175 mil)	-	20006	1
5502	054007-12294	0.840"-1.050" (21,3-26,7 mm)	2/0 AWG (220 mil) 3/0-4/0 AWG 250 kcmil (175 mil)	4/0 AWG	-	1
5502-CI-2/0	054007-09631	0.840"-1.050" (21,3-26,7 mm)	2/0 AWG (220 mil)	-	CI-2/0	1
5502-CI-3/0	054007-09632	0.840"-1.050" (21,3-26,7 mm)	3/0 AWG	4/0 AWG	CI-3/0	1
5502-CI-4/0	054007-09633	0.840"-1.050" (21,3-26,7 mm)	4/0 AWG	-	CI-4/0	1
5502-20009	054007-09634	0.840"-1.050" (21,3-26,7 mm)	250 kcmil (175 mil)	-	20009	1
5503	054007-12295	1.060"-1.210" (26,9-30,7 mm)	250 kcmil (220 mil) 350 kcmil	-	-	1
5503-CI-250	054007-09635	1.060"-1.210" (26,9-30,7 mm)	250 kcmil (220 mil)	-	CI-250	1
5503-CI-350	054007-09636	1.060"-1.210" (26,9-30,7 mm)	350 kcmil	-	CI-350	1
5504	054007-12296	1.120"-1.320" (28,4-33,5 mm)	500 kcmil	-	-	1
5504-CI-500	054007-09637	1.120"-1.320" (28,4-33,5 mm)	500 kcmil	-	CI-500	1
5505	054007-12297	1.320"-1.520" (33,5-38,6 mm)	750 kcmil	-	-	1
5505-CI-750	054007-09638	1.320"-1.520" (33,5-38,6 mm)	750 kcmil	-	CI-750	1

15 kV: 3M™ Molded Rubber Splice Kits: Single Conductor (1/C)

3M™ Aluminum Repair Connectors CIR Series for 3M™ Rubber Splices 5411R & 5412R Series

Meets the requirements of ANSI C119.4

Connector Base Metal Aluminum
For use with Aluminum or Copper Conductor

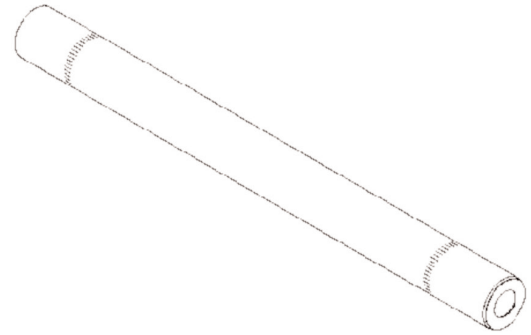

Order No.	UPC	Conductor Size, Stranded	Conductor Size, Solid	Length	Outside Diameter (O.D.)	Compatible with	Case Qty.
CIR-22	054007-09356	4 AWG (220 mil insulation only)	2 AWG	8.0" (203,2 mm)	0.64" (16,2 mm)	5411R Splice Body	10
CIR-2	054007-11966	2 AWG	-	8.0" (203,2 mm)	0.64" (16,2 mm)	5411R Splice Body	10
CIR-21	054007-09357	2 AWG, 1 AWG	1 AWG, 1/0 AWG	8.0" (203,2 mm)	0.64" (16,2 mm)	5411R Splice Body	10
CIR-1/0	054007-09358	1/0 AWG	-	8.0" (203,2 mm)	0.64" (16,2 mm)	5411R Splice Body	10
CIR-2/0	054007-41964	2/0 AWG (220 mil insulation only)	-	9.0" (228,6 mm)	0.91" (23,1 mm)	5412R Splice Body	10
CIR-3/0	054007-41965	3/0 AWG	-	9.0" (228,6 mm)	0.91" (23,1 mm)	5412R Splice Body	10
CIR-4/0	054007-50228	4/0 AWG	-	9.0" (228,6 mm)	0.91" (23,1 mm)	5412R Splice Body	10

3M™ Connectors CI Series for 3M™ Rubber Splices 5400 & 5500 Series

Meets the requirements of ANSI C119.4

Connector Base Metal Aluminum
For use with Aluminum or Copper Conductor

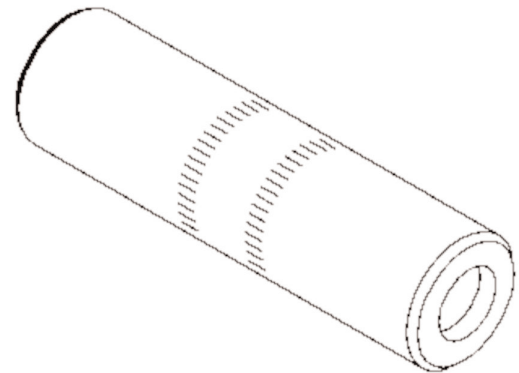

Order No.	UPC	Conductor Size, Stranded, Cu or Al	Connector O.D.	Case Qty.
CI-2/0	054007-11875	2/0 AWG	0.910" (23,1 mm)	10
CI-3/0	054007-11883	3/0 AWG	0.910" (23,1 mm)	10
CI-4/0	054007-11891	4/0 AWG	0.910" (23,1 mm)	10
CI-250	054007-11909	250 kcmil	1.125" (28,6 mm)	10
CI-350	054007-11925	350 kcmil	1.125" (28,6 mm)	10
CI-450	054007-11933	500 kcmil (Compact)	1.312" (33,3 mm)	10
CI-500	054007-25644	500 kcmil	1.312" (33,3 mm)	10
CI-650	054007-11941	750 kcmil (Compact)	1.590" (40,4 mm)	10
CI-750	054007-25651	750 kcmil	1.590" (40,4 mm)	10

15 kV: 3M™ Molded Rubber Splice Kits: Single Conductor (1/C)

3M™ Connectors CI Series for 3M™ Rubber Splices 5411, 5411A, 5412 & 5500 Series

Meets the requirements of ANSI C119.4

Connector Base Metal Aluminum
For use with Aluminum or Copper Conductor

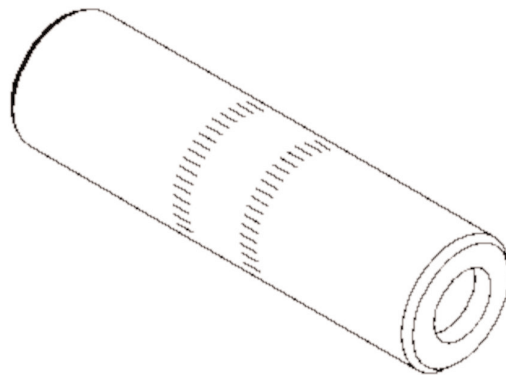

Order No.	UPC	Conductor Size, Stranded, Cu or Al	Conductor Size, Solid, Cu or Al	Connector O.D.	Case Qty.
20006	054007-13285	2/0 AWG	-	0.687" (17,4 mm)	10
20009	054007-13319	250 kcmil	-	0.906" (23,0 mm)	3
CI-1/0	054007-11867	1/0 AWG	-	0.640" (16,2 mm)	10
CI-2	054007-11651	2 AWG	1 AWG	0.640" (16,2 mm)	10
CI-2/0	054007-11875	2/0 AWG	-	0.910" (23,1 mm)	10
CI-21	054007-11856	2, 1 AWG	1, 1/0 AWG	0.640" (16,2 mm)	10
CI-22	054007-25636	4 AWG	2 AWG	0.640" (16,2 mm)	10
CI-3/0	054007-11883	3/0 AWG	-	0.910" (23,1 mm)	10
CI-4/0	054007-11891	4/0 AWG	-	0.910" (23,1 mm)	10

3M™ Aluminum Transition Connectors CI-T Series for 5411 & 5500 Series

Meets the requirements of ANSI C119.4

Connector Base Metal Aluminum
For use with Aluminum or Copper Conductor

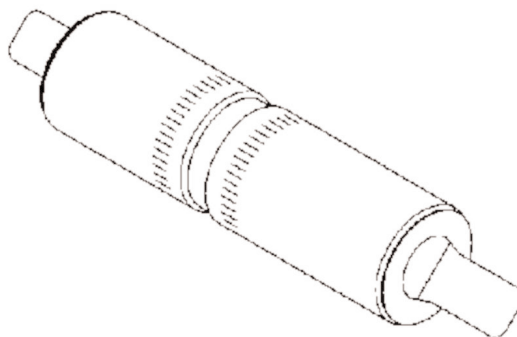

Order No.	UPC	Conductor Size, Cable A – Stranded (Solid)	Conductor Size, Cable B – Stranded (Solid)	Outside Diameter (O.D.)	Case Qty.
CI-T-1	054007-11958	4 AWG (2 AWG)	1 AWG (1/0 AWG)	0.64" (16,2 mm)	10
CI-T-2	054007-11966	2 AWG (1 AWG)	1 AWG (1/0 AWG)	0.64" (16,2 mm)	10
CI-T-3	054007-11974	4 AWG (2 AWG)	1/0 AWG Stranded	0.64" (16,2 mm)	10
CI-T-4	054007-11982	2 AWG (1 AWG)	1/0 AWG Stranded	0.64" (16,2 mm)	10
CI-T-5	054007-11990	2 AWG (1 AWG)	4 AWG (2 AWG)	0.64" (16,2 mm)	10
CI-T-9	054007-44533	1 AWG (1/0 AWG)	1/0 AWG Stranded	0.64" (16,2 mm)	10

15 kV: 3M™ PILC Splice Kits: Single Conductor (1/C)

3M™ Cold Shrink QS-III 1/C Inline Transition Splice Kits 5510A-1T-PILC Series

3M™ Cold Shrink QS-III 1/C Inline Transition Splice Kit 5510A-1T-PILC Series (which includes 5513A-1T-PILC, 5514A-1T-PILC, 5515A-1T-PILC, and 5516A-1T-PILC) are 15 kV class inline splices designed to transition single-conductor PILC to Poly/EPR cable and meet the 15 kV voltage class rating requirements of IEEE 404.

The splice kits include an oil barrier system based on a cold shrink tube design of specially formulated, oil-resistant polymer, that is laboratory tested to nominal internal pressures of 40 psi with no oil leakage. The splice body itself is a one-piece molded QS-III design made of specially formulated silicone rubber. An EPDM rubber fold-back cold shrink jacket is included for physical protection and environmental sealing.

Each kit contains sufficient material to make one splice. Connector is not provided with the kits due to customer specific application requirements. To ensure a positive oil stop, a non-tapered, sealed connector (with a solid center barrier) should be used.

*4 AWG requires use of Al connector as #4 Cu connector is below min. O.D. for the 5513A-1T-PILC kit.

**2/0 AWG & 3/0 AWG require use of Al connector as Cu connectors are below min. O.D. for the 5514A-1T-PILC kit.

Note: Cable sizes shown below are for standard insulation thickness. Final determining factor is cable insulation O.D.

Voltage	15 kV
Number of Conductors	Single Conductor
Shielding Type	Paper Insulated Lead Covered (PILC)
Splice Type	Inline PILC Transition
Technology	Cold Shrink

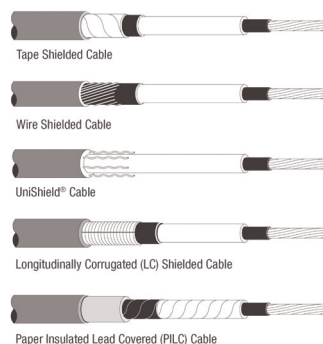

Order No.	UPC 051138-	Max. O.D. Over Lead Sheath	PILC Cable Insul. O.D.	Poly/EPR Cable Insul. O.D.	PILC Cable Conductor Size 100%	PILC Cable Conductor Size 133%	Poly/EPR Cable Conductor Size	Case Qty.
5513A-1T-PILC	94339	1.01" (25,6 mm)	0.59"-0.83" (15-21 mm)	0.64"-1.01" (16-26 mm)	*4-4/0 AWG (22-95 mm ²)	*4-1/0 AWG (22-50 mm ²)	2-4/0 AWG (35-95 mm ²)	1
5514A-1T-PILC	94340	1.23" (31,2 mm)	0.79"-1.07" (20-27 mm)	0.84"-1.38" (22-35 mm)	4/0 AWG-500 kcmil (120-240 mm ²)	**2/0 AWG-250 kcmil (70-120 mm ²)	4/0 AWG-500 kcmil (95-240 mm ²)	1
5515A-1T-PILC	94341	1.53" (38,9 mm)	1.07"-1.32" (28-33 mm)	1.04"-1.70" (27-43 mm)	500-750 kcmil (300-325 mm ²)	250-550 kcmil (150-250 mm ²)	300-750 kcmil (185-325 mm ²)	1
5516A-1T-PILC	94342	1.85" (47,0 mm)	1.24"-1.63" (32-41 mm)	1.08"-1.70" (28-43 mm)	750-1000 kcmil (400-500 mm ²)	500-1000 kcmil (300-500 mm ²)	500-1000 kcmil (240-500 mm ²)	1

15 kV: 3M™ PILC Splice Kits: Single Conductor (1/C)

3M™ Cold Shrink Splice Kits QS-2000T 1/C PILC to 1/C Poly/EPR or 1/C PILC to 1/C PILC Cable Splices

The 3M™ Cold Shrink Splice Kit QS-2000T Series allows you to splice either single-conductor PILC cable to single-conductor PILC cable, or single-conductor PILC cable to single-conductor Poly/EPR cable. Because of the design of the splice, size transitions can also be accommodated rather easily. The 3M™ Cold Shrink Splice Kit QS-2000T Series meets the requirements of IEEE 404.

Use 3M™ Scotchlok™ Connectors 2000T Series with these splice kits. Each kit contains sufficient quantities of material to make one splice.

Note: Cable sizes shown below are for standard insulation thickness. Final determining factor is cable insulation O.D.

Voltage	15 kV
Number of Conductors	Single Conductor
Shielding Type	Paper Insulated Lead Covered (PILC)
Splice Type	Inline PILC Transition or Inline PILC
Technology	Cold Shrink

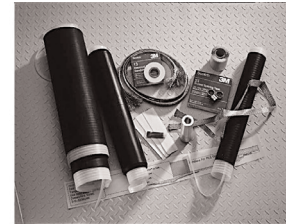

Order No.	UPC 054007-	PILC Cable Insul. O.D. Range	PILC Cable Conductor Size	Poly/EPR Cable Insul. O.D. Range	Poly/EPR Cable Conductor Size	Connector O.D. Range	Connector Max. Length	Case Qty.
QS2011T	50546	0.56-0.88" (14,2-22,4 mm)	4-3/0 AWG (25-70 mm ²)	0.70"-1.07" (17,8-27,2 mm)	1-4/0 AWG (50-95 mm ²)	0.70"-1.02" (17,8-25,8 mm)	Al: 5.0" (127 mm) Cu: 5.5" (140 mm)	1
QS2012T	50547	0.74"-1.17" (18,8-29,7 mm)	3/0 AWG-350 kcmil (95-185 mm ²)	0.88"-1.36" (22,0-34,6 mm)	4/0 AWG-500 kcmil (120-240 mm ²)	0.90"-1.30" (23,0-51,0 mm)	Al: 5.2" (132 mm) Cu: 5.5" (140 mm)	1
QS2013T	50555	0.98"-1.56" (24,9-39,6 mm)	400-1000 kcmil (200-500 mm ²)	1.12"-1.70" (28,4-43,2 mm)	500-1000 kcmil (240-500 mm ²)	1.10"-1.66" (28,0-42,0 mm)	Al: 6.5" (165 mm) Cu: 7.5" (190 mm)	1

15 kV: 3M™ PILC Splice Kits: Three Conductor (3/C)

3M™ Cold Shrink Splice Kits QS-2000-3T and QS-2000-3T-WS 3/C PILC to 1/C Poly/EPR Cable Trifurcating Splices

3M™ Cold Shrink Splice Kit QS-2000-3T and QS-2000-3T-WS Trifurcating Transition Splices are rated 15 kV. They are specially designed splice kits for connecting one 3/C Paper Insulated Lead Covered (PILC) cable to three 1/C Poly/EPR insulated cables. Splices meet the requirements of IEEE 404.

3M™ Scotchlok™ Connector 2000T Series are recommended for use with these kits and must be ordered separately. Each kit makes one 3/C to three 1/C splice.

*QS-2000-3T-WS uses wrap around heat shrink re-jacketing.

Note: Cable sizes shown below are for standard insulation thickness. Final determining factor is cable insulation O.D.

Voltage	15 kV
Number of Conductors	Three Conductor to Single Conductor
Shielding Type	Paper Insulated Lead Covered (PILC)
Splice Type	PILC Trifurcating
Technology	Cold Shrink

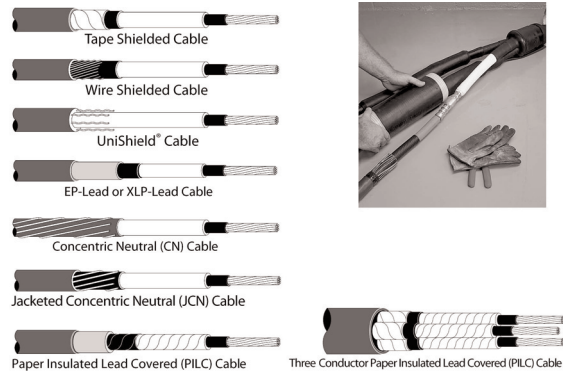

Order No.	UPC 054007-	PILC Cable Conductor Size	Poly/EPR Cable Conductor Size	Poly/EPR Cable Insul. O.D. Range	Connector O.D. Range	Connector Max. Length	Case Qty.
QS2011-3T	42021	4-3/0 AWG (25-70 mm ²)	1-4/0 AWG (50-95 mm ²)	0.70"-1.07" (17,8-27,2 mm)	0.70"-1.02" (17,8-25,8 mm)	Al: 5.0" (127 mm); Cu: 5.5" (140 mm)	1
QS2012-3T	42022	3/0 AWG-250 kcmil (95-120 mm ²)	4/0 AWG-500 kcmil (120-240 mm ²)	0.88"-1.36" (22,0-34,6 mm)	0.90"-1.30" (22,9-33,0 mm)	Al: 5.2" (132 mm); Cu: 5.5" (140 mm)	1
QS2012/13-3T	44202	350-500 kcmil (195-240 mm ²)	250-500 kcmil (120-240 mm ²)	0.91"-1.36" (23,0-34,6 mm)	0.90"-1.30" (22,9-33,0 mm)	Al: 5.2" (132 mm); Cu: 5.5" (140 mm)	1
QS2013-3T	42023	400-800 kcmil (200-400 mm ²)	500-1000 kcmil (240-500 mm ²)	1.12"-1.70" (28,0-43,0 mm)	1.10"-1.66" (28,0-42,0 mm)	Al: 6.5" (165 mm); Cu: 7.5" (190 mm)	1
QS2011-3T-WS*	43248	4-3/0 AWG (25-70 mm ²)	1-4/0 AWG (50-95 mm ²)	0.70"-1.07" (17,8-27,2 mm)	0.70"-1.02" (17,8-25,8 mm)	Al: 5.0" (127 mm); Cu: 5.5" (140 mm)	1
QS2012-3T-WS*	04211	3/0 AWG-250 kcmil (95-120 mm ²)	4/0 AWG-500 kcmil (120-240 mm ²)	0.88"-1.36" (22,0-34,6 mm)	0.90"-1.30" (22,9-33,0 mm)	Al: 5.2" (132 mm); Cu: 5.5" (140 mm)	1
QS2012/13-3T-WS*	04644	350-500 kcmil (195-240 mm ²)	250-500 kcmil (120-240 mm ²)	0.91"-1.36" (23,0-34,6 mm)	0.90"-1.30" (22,9-33,0 mm)	Al: 5.2" (132 mm); Cu: 5.5" (140 mm)	1
QS2013-3T-WS*	04212	400-800 kcmil (200-400 mm ²)	500-1000 kcmil (240-500 mm ²)	1.12"-1.70" (28,0-43,0 mm)	1.10"-1.66" (28,0-42,0 mm)	Al: 6.5" (165 mm); Cu: 7.5" (190 mm)	1

15 kV: 3M™ PILC Splice Kits: Three Conductor (3/C)

3M™ Cold Shrink 3/C PILC to 3/C Poly/EPR Cable Transition Splice Kit QS-2013-3T-3C

The 3M™ Cold Shrink Splice Kit QS-2013-3T-3C is rated for 15 kV cables. It is specially designed for connecting 3/C shielded or belted Paper Insulated Lead Covered (PILC) cable to 3/C shielded Poly/EPR insulated cables. The splice meets the requirements of IEEE 404.

3M™ Scotchlok™ Connector 2000T Series are recommended for this kit and must be ordered separately. Each kit has sufficient material to make one 3/C to 3/C splice.

Note: Cable sizes shown below are for standard insulation thickness. Final determining factor is cable insulation O.D.

Voltage	15 kV
Number of Conductors	Three Conductor
Shielding Type	Paper Insulated Lead Covered (PILC)
Splice Type	Inline PILC Transition
Technology	Cold Shrink

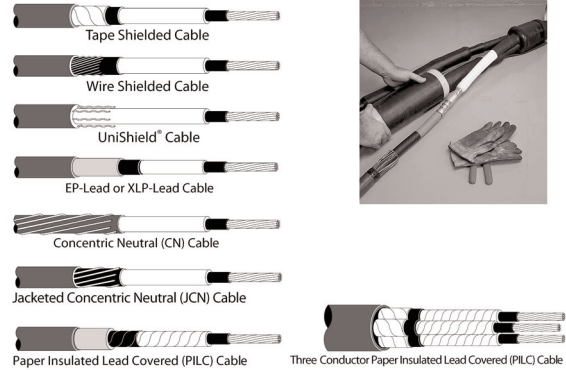

Order No.	UPC 054007-	PILC Cable Conductor Size	Poly/EPR Cable Conductor Size	Poly/EPR Cable Insul. O.D. Range	Connector O.D. Range	Connector Max. Length	Case Qty.
QS2013-3T-3C	43247	400-800 kcmil (200-400 mm ²)	500-750 kcmil (240-325 mm ²)	1.12"-1.70" (28,4-43,2 mm)	1.10"-1.66" (28,0-42,0 mm)	Al: 6.5" (165 mm); Cu: 7.5" (190 mm)	1

15 kV: 3M™ PILC Splice Kits: Three Conductor (3/C)

3M™ Scotchlok™ Connectors 2000T-CU for 15 kV

The 3M™ Scotchlok™ Connectors 2000T-CU Series are copper inline sleeves for use with copper conductor cables of the same size and are specifically designed for use with PILC power cable. They can be used on concentric, compressed, and compact stranded conductors. A rounding die is recommended to round out the sector shape of the connector when used with sector shaped conductors. The 2000T-CU connectors, like all 2000T series connectors, have a solid center oil stop and meet ANSI Standard C-119.4. They are designed for use with splice kits from the 3M™ Cold Shrink Splice Kit QS-2000T Series, the 3M™ Cold Shrink Splice Kit QS-2000-3T Series, the 3M™ Cold Shrink CS500Pb Series, and the Scotch® Tape Splice Kits 5700 Series. Meets the requirements of ANSI C119.4



Connector Base Metal Copper
For use with Copper Conductor

Order No.	UPC	Stranded Conductor Size	Length	Outside Diameter (O.D.)	Min. Order Qty.	Case Qty.
2000T-2-CU	054007-42247	2 AWG	5.32" (135,1 mm)	0.700" (17,8 mm)	9	9
2000T-2/0-CU	054007-42250	2/0 AWG	5.32" (135,1 mm)	0.700" (17,8 mm)	3	3
2000T-4/0-CU	054007-42252	4/0 AWG	5.25" (133,3 mm)	0.880" (22,3 mm)	3	3
2000T-250-CU	054007-42253	250 kcmil	5.25" (133,3 mm)	0.880" (22,3 mm)	3	3
2000T-500-CU	054007-42258	500 kcmil	6.90" (175,3 mm)	1.125" (28,6 mm)	3	3
2000T-750-CU	054007-42263	750 kcmil	6.90" (175,3 mm)	1.300" (33,0 mm)	3	3

15 kV: 3M™ PILC Splice Kits: Three Conductor (3/C)

3M™ Scotchlok™ Reducer Series Connectors 2000T-CU/AL for 15 kV

The 3M™ Scotchlok™ Reducer Series Connectors 2000T-CU/AL are aluminum inline sleeves that are applicable for both aluminum and copper conductors and specifically designed for use with PILC power cable. The barrel inner diameters on each end are different, allowing the connection of different size conductors. These connectors can be used on concentric, compressed, and compact stranded conductors. A rounding die is recommended to round out the sector shape of the connector when used with sector shaped conductors. The 2000T Reducer Series connectors, like all 2000T series connectors, have a solid center oil stop and meet ANSI Standard C-119.4. They are designed for use with splice kits from the 3M™ Scotchlok™ 2000T Series, the 3M™ Scotchlok™ 2000-3T Series, the 3M™ Cold Shrink Splice Kits Selection CS500Pb Series, and the Scotch® Tape Splice Kits 5700 Series. Each connector is electro-tin plated to resist electrolytic corrosion. Meets the requirements of ANSI C119.4



Connector Base Metal Aluminum
For use with Copper or Aluminum Conductor

Order No.	UPC	Stranded Conductor Size	Length	Outside Diameter (O.D.)	Min. Order Qty.	Case Qty.
2000T 2-1/0 CU/AL	054007-42226	2-1/0 AWG	4.74" (120,4 mm)	0.640" (16,2 mm)	9	9
2000T 1/0-2/0 CU/AL	054007-42228	1/0-2/0 AWG	4.70" (119,4 mm)	0.910" (23,1 mm)	3	3
2000T 2/0-4/0 CU/AL	054007-42229	2/0-4/0 AWG	4.70" (119,4 mm)	0.910" (23,1 mm)	3	3
2000T 250-350 CU/AL	054007-42232	250-350 kcmil	4.70" (119,4 mm)	1.125" (28,6 mm)	3	3
2000T 350-500 CU/AL	054007-42234	350-500 kcmil	4.70" (119,4 mm)	1.320" (33,5 mm)	3	3
2000T 500-750 CU/AL	054007-42236	500-750 kcmil	6.25" (158,7 mm)	1.600" (40,6 mm)	3	3
2000T 500-1000 CU/AL	054007-42238	500-1000 kcmil	6.25" (158,7 mm)	1.625" (41,3 mm)	3	3
2000T 750-1000 CU/AL	054007-42243	750-1000 kcmil	6.25" (158,7 mm)	1.625" (41,3 mm)	3	3

15 kV: 3M™ Tape Splice Kits: Single Conductor (1/C)

Scotch® Inline and Tee Tape Shielded Cable Splice Kits 5700 Series

Scotch® Inline and Tee Tape Shielded Cable Splice Kits 5700 Series handle inline and tee splices on tape shielded, wire shielded or UniShield® cables with copper (Cu) or aluminum (Al) conductors. Kits are rated 5 kV-15 kV, and each kit makes three splices. Use the selector chart to determine the proper kit needed. Connectors and Lugs need to be ordered separately. 3M does not offer tee connectors.

Note: Cable sizes shown below are for standard insulation thickness. Final determining factor is cable insulation O.D.

Voltage: 5 kV, 5/8 kV, 15 kV

Number of Conductors: Single Conductor

Shielding Type: Tape Shield, Wire Shield, UniShield®

Splice Type: Inline, Tee

Technology: Tape

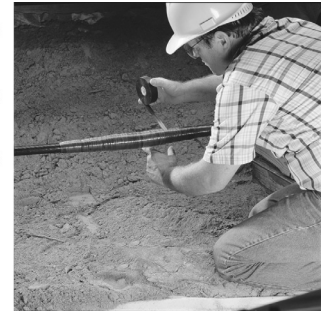
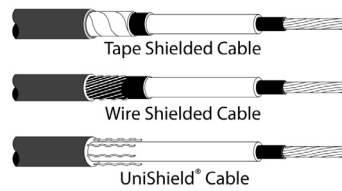

		Inline Splices						Tee Splices*						Case Qty.
Product Number	UPC (054007-)	5 and 8 kV		15 kV 100% 175mil		15 kV 133% 220 mil		5 and 8 kV		15 kV 100% 175 mil		15 kV 133% 220 mil		
		Cu	Al	Cu	Al	Cu	Al	Cu	Al	Cu	Al	Cu	Al	
Tape Shielded Cable, Wire Shielded Cable, UniShield® Cable See above for cable type illustrations.														
5717	12030	4-250 (22-125)	4-4/0 (2-100)	4-2 (22-30)	—	4	—	—	—	—	—	—	—	1
5718	12048	300-500 (180-250)	250 (150)	1-4/0 (50-100)	4-2/0 (22-60)	2-1/0 (35-60)	—	4-2/0 (22-60)	4-1/0 (22-50)	—	—	—	—	1
5719	12055	550-1000 (300-500)	300-500 (180-250)	250-500 (180-250)	3/0-250 (95-125)	2/0-350 (70-180)	4-3/0 (22-80)	3/0-350 (95-180)	2/0-4/0 (70-100)	4-1 (22-38)	—	—	—	1
5720	12063	—	500-1000 (300-500)	550-1000 (300-500)	300-750 (180-325)	400-750 (240-325)	4/0-500 (120-250)	400-750 (240-325)	250-500 (125-250)	1/0-350 (60-180)	4-4/0 (22-100)	4-250 (22-125)	4-3/0 (22-80)	1

*3M does not offer tee compression connectors.

Note: Larger-numbered kits may be used in place of smaller-numbered kits (with excess materials left over).

Order No.	UPC	Case Qty.
5717	054007-12030	1
5718	054007-12048	1
5719	054007-12055	1
5720	054007-12063	1

25/28 kV Medium Voltage Splices

The following 3M products cover splicing needs for applications up to 25/28 kV, and promote dependable performance, stability and long life with every splice you make.



Section	Page
25/28 kV	210-221
3M™ Cold Shrink Splice Kits	211-215
Single Conductor (1/C)	211-213
3M™ Cold Shrink QS-III Inline CN/JCN Cable Splice Kits 5456A, 5457A and 5458A Series	211-212
3M™ Cold Shrink QS-III Inline Shielded Cable Splice Kits 5524A, 5525A and 5526A	212-213
Three Conductor (3/C)	214-215
3M™ Cold Shrink QS-III 3/C Armored or Non-Armored Cable Splice Kits 5786A-MT, 5787A-MT & 5788A-MT	214
3M™ Cold Shrink MT-C & MT-E Trifurcating Accessory Kits (One 3/C to Three 1/C) for 25/28 kV.....	215
3M™ Molded Rubber Splice Kits	216-219
Single Conductor (1/C)	216-219
3M™ Molded Rubber QS-II Inline CN/JCN Cable Splice Kits 5420 Series	216
3M™ Molded Rubber QS-II Inline CN/JCN Cable Splice Kits 5450 Series	217
3M™ Molded Rubber QS-II Inline CN/JCN Cable Splice Kits 5451A Series	218-219
3M™ Connectors CI and CI-A Series.....	219
3M™ Molded Rubber Cable Repair Splice Kit 5451R	220
Single Conductor (1/C).....	220
3M™ Molded Rubber QS-II JCN Cable Repair Splice Kits 5451R Series	220
3M™ Aluminum Repair Connector CIR Series for 3M™ Molded Rubber QS-II JCN Cable Repair Splice Kit 5451R.....	220
3M™ PILC Splice Kits	221
Single Conductor (1/C).....	221
3M™ Cold Shrink QS-III 1/C Transition Splice Kits 5520A-1T-PILC Series	221

3M™ Cold Shrink QS-III Inline CN/JCN Cable Splice Kits 5456A, 5457A and 5458A Series

3M™ Cold Shrink QS-III Inline CN/JCN Cable Splices 5456A-WG, 5457A-WG and 5458A-WG are inline splices for joining 25/28 kV jacketed concentric neutral (JCN) or concentric neutral (CN) power cables. It is a cold shrink design. The cold shrink splice body is a one-piece molded design made of specially formulated silicone rubbers, while the jacketing is made of EPDM rubber for its special physical properties. Each splice is high-voltage production tested to ensure reliability. Kits can be ordered with connectors packed in the kit or the kit and connector can be ordered as separate items. Meets requirements of IEEE 404.

Each kit makes one splice.

Note: 5456A-WG, 5457A-WG and 5458A-WG are partially jacketed splices containing built-in bleeder wires. Additional end user materials are required to convert to full jacketing.

Note: Cable sizes shown below are for standard insulation thickness. Final determining factor is cable insulation O.D.

Voltage	25/28 kV
Number of Conductors	Single Conductor
Shielding Type	Concentric Neutral (CN), Jacketed Concentric Neutral (JCN)
Splice Type	Inline
Technology	Cold Shrink



Order No.	UPC	Insulation O.D.	Conductor Size	Connector Included	Case Qty.
5456A	051128-53793	0.84"-1.36" (21,3-34,5 mm)	1 AWG-250 kcmil (50-120 mm ²)	-	1
5456A-1-AL	051128-53794	0.84"-1.36" (21,3-34,5 mm)	1 AWG	20004	1
5456A-1-CU	051128-53795	0.84"-1.36" (21,3-34,5 mm)	1 AWG	10004	1
5456A-1/0-AL	051128-53796	0.84"-1.36" (21,3-34,5 mm)	1/0 AWG	20005	1
5456A-1/0-CU	051128-53797	0.84"-1.36" (21,3-34,5 mm)	1/0 AWG	10005	1
5456A-2/0-AL	051128-53798	0.84"-1.36" (21,3-34,5 mm)	2/0 AWG	20006	1
5456A-2/0-CU	051128-53799	0.84"-1.36" (21,3-34,5 mm)	2/0 AWG	10006	1
5456A-3/0-AL	051128-53800	0.84"-1.36" (21,3-34,5 mm)	3/0 AWG	20007	1
5456A-3/0-CU	051128-53801	0.84"-1.36" (21,3-34,5 mm)	3/0 AWG	10007	1
5456A-4/0-AL	051128-53802	0.84"-1.36" (21,3-34,5 mm)	4/0 AWG	20008	1
5456A-4/0-CU	051128-53803	0.84"-1.36" (21,3-34,5 mm)	4/0 AWG	10008	1
5456A-250-AL	051128-53935	0.84"-1.36" (21,3-34,5 mm)	250 kcmil	20009	1
5456A-250-CU	051128-53936	0.84"-1.36" (21,3-34,5 mm)	250 kcmil	10009	1
5456A-WG	051128-53804	0.84"-1.36" (21,3-34,5 mm)	1 AWG-250 kcmil (50-120 mm ²)	-	1
5457A	054007-42149	1.07"-1.70" (27,2-43,2 mm)	250-500 kcmil (120-240 mm ²)	-	1
5457A-250-AL	051128-53836	1.07"-1.70" (27,2-43,2 mm)	250 kcmil	20009	1
5457A-250-CU	051128-53837	1.07"-1.70" (27,2-43,2 mm)	250 kcmil	10009	1
5457A-350-AL	054007-42132	1.07"-1.70" (27,2-43,2 mm)	350 kcmil	20011	1
5457A-350-CU	054007-44238	1.07"-1.70" (27,2-43,2 mm)	350 kcmil	10011	1
5457A-500-AL	054007-42133	1.07"-1.70" (27,2-43,2 mm)	500 kcmil	20014	1
5457A-500-CU	054007-44239	1.07"-1.70" (27,2-43,2 mm)	500 kcmil	10014	1
5457A-WG	054007-43416	1.07"-1.70" (27,2-43,2 mm)	250-500 kcmil (120-240 mm ²)	-	1
5458A	054007-42908	1.24"-2.07" (31,5-52,6 mm)	500-1000 kcmil (240-500 mm ²)	-	1
5458A-500-AL	054007-04593	1.24"-2.07" (31,5-52,6 mm)	500 kcmil	20014	1
5458A-500-CU	054007-04594	1.24"-2.07" (31,5-52,6 mm)	500 kcmil	10014	1
5458A-750-AL	054007-42909	1.24"-2.07" (31,5-52,6 mm)	750 kcmil	20019	1

25/28 kV: 3M™ Cold Shrink Splice Kits: Single Conductor (1/C)

3M™ Cold Shrink QS-III Inline CN/JCN Cable Splice Kits 5456A, 5457A and 5458A Series (continued)

Order No.	UPC	Insulation O.D.	Conductor Size	Connector Included	Case Qty.
5458A-750-CU	054007-44240	1.24"-2.07" (31,5-52,6 mm)	750 kcmil	10019	1
5458A-1000-AL	054007-42910	1.24"-2.07" (31,5-52,6 mm)	1000 kcmil	20024	1
5458A-1000-CU	054007-44241	1.24"-2.07" (31,5-52,6 mm)	1000 kcmil	10024	1
5458A-WG	054007-43417	1.24"-2.07" (31,5-52,6 mm)	500-1000 kcmil (240-500 mm ²)	-	1

3M™ Cold Shrink QS-III Inline Shielded Cable Splice Kits 5524A, 5525A and 5526A

3M™ Cold Shrink QS-III Inline Shielded Cable Splices 5524A, 5525A and 5526A Series are inline splices for joining 25/28 kV tape shield, wire shield, UniShield® or longitudinally corrugated (LC) shielded power cables. It is a cold shrink design. The cold shrink splice body is a one-piece molded design made of specially formulated silicone rubbers, while the jacketing is made of EPDM rubber for its special physical properties. Each splice is high-voltage production tested to ensure reliability. Kits can be ordered with connectors packed in the kit, or the kit and connector can be ordered as separate items. Meets requirements of IEEE 404.

Each kit makes one splice.

Note: Cable sizes shown below are for standard insulation thickness. Final determining factor is cable insulation O.D.

<p>Voltage 25/28 kV</p> <p>Number of Conductors Single Conductor</p> <p>Shielding Type Tape Shield, Wire Shield, UniShield®, Longitudinally Corrugated (LC)</p> <p>Splice Type Inline</p> <p>Technology Cold Shrink</p>		
--	---	--

Order No.	UPC	Insulation O.D.	Conductor Size	Connector Included	Case Qty.
5524A	051128-53922	0.84"-1.36" (21,3-34,5 mm)	1 AWG-250 kcmil (50-120 mm ²)	-	1
5524A-1-AL	051128-53923	0.84"-1.36" (21,3-34,5 mm)	1 AWG	20004	1
5524A-1-CU	051128-53924	0.84"-1.36" (21,3-34,5 mm)	1 AWG	10004	1
5524A-1/0-AL	051128-53925	0.84"-1.36" (21,3-34,5 mm)	1/0 AWG	20005	1
5524A-1/0-CU	051128-53926	0.84"-1.36" (21,3-34,5 mm)	1/0 AWG	10005	1
5524A-2/0-AL	051128-53927	0.84"-1.36" (21,3-34,5 mm)	2/0 AWG	20006	1
5524A-2/0-CU	051128-53928	0.84"-1.36" (21,3-34,5 mm)	2/0 AWG	10006	1
5524A-3/0-AL	051128-53929	0.84"-1.36" (21,3-34,5 mm)	3/0 AWG	20007	1
5524A-3/0-CU	051128-53930	0.84"-1.36" (21,3-34,5 mm)	3/0 AWG	10007	1
5524A-4/0-AL	051128-53931	0.84"-1.36" (21,3-34,5 mm)	4/0 AWG	20008	1
5524A-4/0-CU	051128-53932	0.84"-1.36" (21,3-34,5 mm)	4/0 AWG	10008	1
5524A-250-AL	051128-53933	0.84"-1.36" (21,3-34,5 mm)	250 kcmil	20009	1
5524A-250-CU	051128-53934	0.84"-1.36" (21,3-34,5 mm)	250 kcmil	10009	1
5525A	054007-42138	1.07"-1.70" (27,2-43,2 mm)	250-750 kcmil (120-325 mm ²)	-	1
5525A-250-AL	051128-53845	1.07"-1.70" (27,2-43,2 mm)	250 kcmil	20009	1
5525A-250-CU	051128-53846	1.07"-1.70" (27,2-43,2 mm)	250 kcmil	10009	1
5525A-350-AL	054007-42140	1.07"-1.70" (27,2-43,2 mm)	350 kcmil	20011	1
5525A-350-CU	054007-42902	1.07"-1.70" (27,2-43,2 mm)	350 kcmil	10011	1
5525A-500-AL	054007-42141	1.07"-1.70" (27,2-43,2 mm)	500 kcmil	20014	1
5525A-500-CU	054007-42903	1.07"-1.70" (27,2-43,2 mm)	500 kcmil	10014	1
5525A-750-AL	054007-42904	1.07"-1.70" (27,2-43,2 mm)	750 kcmil	20019	1
5525A-750-CU	054007-42127	1.07"-1.70" (27,2-43,2 mm)	750 kcmil	10019	1

Medium Voltage Splice Kits, 5 kV-46 kV

25/28 kV: 3M™ Cold Shrink Splice Kits: Single Conductor (1/C)

3M™ Cold Shrink QS-III Inline Shielded Cable Splice Kits 5524A, 5525A and 5526A (continued)

Order No.	UPC	Insulation O.D.	Conductor Size	Connector Included	Case Qty.
5526A	054007-42905	1.24"-2.07" (31,5-52,6 mm)	500-1000 kcmil (240-500 mm ²)	-	1
5526A-500-AL	054007-04597	1.24"-2.07" (31,5-52,6 mm)	500 kcmil	20014	1
5526A-500-CU	054007-04598	1.24"-2.07" (31,5-52,6 mm)	500 kcmil	10014	1
5526A-750-AL	054007-04595	1.24"-2.07" (31,5-52,6 mm)	750 kcmil	20019	1
5526A-750-CU	054007-04596	1.24"-2.07" (31,5-52,6 mm)	750 kcmil	10019	1
5526A-1000-AL	054007-42906	1.24"-2.07" (31,5-52,6 mm)	1000 kcmil	20024	1
5526A-1000-CU	054007-42907	1.24"-2.07" (31,5-52,6 mm)	1000 kcmil	10024	1

25/28 kV: 3M™ Cold Shrink Splice Kits: Three Conductor (3/C)

3M™ Cold Shrink QS-III 3/C Armored or Non-Armored Cable Splice Kits 5786A-MT, 5787A-MT & 5788A-MT

3M™ Cold Shrink QS-III 3/C Inline Armored or Non-Armored Cable Splices 5786A-MT, 5787A-MT and 5788A-MT are designed for splicing 3-conductor, armored and non-armored, shielded power cables. The kits are rated for use on 25/28 kV cables with conductor sizes from 1 AWG-1000 kcmil (50-500 mm²). The kits are designed to be used with 3M™ Scotchlok™ Connectors 10000 and 20000 Series or other UL listed inline compression connectors that fit within the dimension limits listed in the connector dimensional requirements on the data sheet.

The splice utilizes several technologies to accommodate the various functions of a 3/C shielded power cable: 3M™ Cold Shrink QS-III Splice Bodies, Scotch® Tapes for moisture sealing, Constant Force Springs for connecting ground braid jumpers and Armorcast for replacing the cable armor and/or jacket. The completed splice is designed for use in cable trays, weather exposed or direct burial locations. Meets the requirements of IEEE 404.

Connectors are not included in the kit and must be ordered separately.

Note: When making a trifurcating splice, the 3M™ Cold Shrink MT-C or MT-E Trifurcating Accessory Kit must be used along with the splice kit.

Note: Cable sizes shown below are for standard insulation thickness. Final determining factor is cable insulation O.D.

Voltage	25/28 kV
Number of Conductors	Three Conductor
Shielding Type	Shielded Armored or Non-Armored
Splice Type	Inline, Trifurcating
Technology	Cold Shrink



Three-Conductor Armored, Shielded Cable



Three-Conductor Non-Armored, Shielded Cable

Order No.	UPC	Conductor Size	Insulation O.D.	Connector O.D.	Typical Splice Length	Suggested Accessory	Case Qty.
5786A-MT	051128-53937	1 AWG-250 kcmil (50-120 mm ²)	0.84"-1.36" (21,3-34,5 mm)	0.46"-1.36" (11,7-34,5 mm)	57" (1447,8 mm)	3M™ Trifurcating Accessory for 3-C to 3 Single Conductors MT-C; 3M™ Trifurcating Accessory for 3-C to 3 Single Conductors MT-E	1
5787A-MT	054007-43421	250-750 kcmil (120-325 mm ²)	1.07"-1.70" (27,2-43,2 mm)	0.75"-1.70" (19,1-43,2 mm)	62" (1574,8 mm)	3M™ Trifurcating Accessory for 3-C to 3 Single Conductors MT-E	1
5788A-MT	054007-43422	500-1000 kcmil (240-500 mm ²)	1.24"-2.07" (31,5-52,6 mm)	1.05"-2.07" (26,7-52,6 mm)	66" (1676,4 mm)	3M™ Trifurcating Accessory for 3-C to 3 Single Conductors MT-E	1

25/28 kV: 3M™ Cold Shrink Splice Kits: Three Conductor (3/C)

3M™ Cold Shrink MT-C & MT-E Trifurcating Accessory Kits (One 3/C to Three 1/C) for 25/28 kV

3M™ Cold Shrink MT-C and MT-E Trifurcating Accessory Kits are used to break out and seal a transition from 3/C to three 1/C.

For use with 3M™ Cold Shrink QS-III Splicing Series 5700A-MT.

Voltage: 25/28 kV

Number of Conductors: One 3/C to three 1/C



Selection Table

3M™ Splice 57XXA-MT	25/28 kV (260/280 mil)	Appropriate MT Transition Kit
Typical Conductor Size Range – AWG/kcmil*		
5786A-MT	1- 2/0	MT-C
5786A-MT	3/0-250	MT-E
5787A-MT	250-500	MT-E
5788A-MT	500	MT-E

Order No.	UPC	Single Conductor Jacket O.D.	Kits per Case
MT-C	051128-55208	0.62"-1.13" (15,7-28,7 mm)	1
MT-E	051128-54318	1.13"-1.80" (28,7-45,7 mm)	1

25/28 kV: 3M™ Molded Rubber Splice Kits: Single Conductor (1/C)

3M™ Molded Rubber QS-II Inline CN/JCN Cable Splice Kits 5420 Series

3M™ Molded Rubber QS-II Inline CN/JCN Cable Splice Kits 5420 Series are inline splices designed for use on 25 kV CN or JCN cable. The continuous current rating of each splice is equal to the current rating of the cable it is sized to accommodate. Meets requirements of IEEE 404 for cable joints.

Each kit makes one splice. Connectors, unless specified, are not included in the kit, and must be ordered separately.

Note: If connector is desired packed with any of the kits shown above, add the connector number after the splice number (example: 5420-CI-22A). Jacketing kit is needed for JCN cable.

Note: Cable sizes shown below are for standard insulation thickness. Final determining factor is cable insulation O.D.

Voltage	25/28 kV
Number of Conductors	Single Conductor
Shielding Type	Concentric Neutral (CN), Jacketed Concentric Neutral (JCN)
Splice Type	Inline
Technology	Molded Rubber



Concentric Neutral (CN) Cable



Jacketed Concentric Neutral (JCN) Cable



Order No.	UPC	Insulation O.D.	Conductor Size	Connector Included	Case Qty.
5420	054007-15819	0.795"-0.940" (20,2-23,9 mm)	2-1/0 AWG (35-50 mm ²)	-	1
5420-CI-22A	054007-15820	0.795"-0.940" (20,2-23,9 mm)	2 AWG Solid	CI-22A	1
5421	054007-15827	0.920"-1.080" (23,4-27,4 mm)	1/0-3/0 AWG (60-80 mm ²)	-	1
5422	054007-15835	1.060"-1.210" (26,9-30,7 mm)	3/0-4/0 AWG (95-100 mm ²)	-	1
5423	054007-15843	1.120"-1.320" (28,4-33,5 mm)	250-350 kcmil (125-180 mm ²)	-	1
5423-CI-350	054007-08384	1.120"-1.320" (28,4-33,5 mm)	350 kcmil	CI-350	1
5424	054007-15850	1.320"-1.520" (33,5-38,6 mm)	500 kcmil	-	1
5425	054007-09240	1.390"-1.590" (35,0-40,0 mm)	750 kcmil compact	-	1
5426	054007-09239	1.550"-1.710" (39,4-43,4 mm)	750 kcmil	-	1
5426-CI-750	054007-09177	1.550"-1.710" (39,4-43,4 mm)	750 kcmil	CI-750	1

25/28 kV: 3M™ Molded Rubber Splice Kits: Single Conductor (1/C)

3M™ Molded Rubber QS-II Inline CN/JCN Cable Splice Kits 5450 Series

The 3M™ Molded Rubber QS-II Inline CN/JCN Cable Splice Kits 5450 Series kits are one-piece inline splices designed for use on 25/28 kV CN and JCN cable. Meets requirements of IEEE 404 for cable joints.

Each kit makes one splice. Connectors, unless specified, are not included in the kit, and must be ordered separately.

Use the primary insulation O.D. range for final conductor size ordering criteria. If connector is desired packed with any of the kits shown above, add the connector number after the splice number (example: 5451-CI-1/0A). Jacketing kit is needed for JCN cable.

Note: Cable sizes shown below are for standard insulation thickness. Final determining factor is cable insulation O.D.

Voltage	25/28 kV
Number of Conductors	Single Conductor
Shielding Type	Concentric Neutral (CN), Jacketed Concentric Neutral (JCN)
Splice Type	Inline
Technology	Molded Rubber

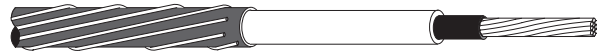

Concentric Neutral (CN) Cable



Jacketed Concentric Neutral (JCN) Cable

Order No.	UPC	Insulation O.D. Range	Conductor Size	Connector Included	Case Qty.
5451	054007-09127	0.83"-1.04" (21,1-26,4 mm)	2-2/0 AWG (60 mm ²)	-	1
5451-CI-2A	054007-09152	0.83"-1.04" (21,1-26,4 mm)	2 AWG (33 mm ²)	CI-2A	1
5451-CI-1A	054007-09935	0.83"-1.04" (21,1-26,4 mm)	1 AWG (42 mm ²)	CI-1A	1
5451-CI-21-840	054007-09154	0.83"-1.04" (21,1-26,4 mm)	2-1 AWG (33-42 mm ²)	CI-21-840	1
5451-CI-1/0A	054007-09153	0.83"-1.04" (21,1-26,4 mm)	1/0 AWG (53 mm ²)	CI-1/0A	1
5451-CI-1/0-840	054007-09155	0.83"-1.04" (21,1-26,4 mm)	1/0 AWG (53 mm ²)	CI-1/0-840	1
5452	054007-09128	1.00"-1.15" (25,4-29,2 mm)	3/0-4/0 AWG (95 mm ²)	-	1

25/28 kV: 3M™ Molded Rubber Splice Kits: Single Conductor (1/C)

3M™ Molded Rubber QS-II Inline CN/JCN Cable Splice Kits 5451A Series

The 3M™ Molded Rubber QS-II Inline CN/JCN Cable Splice Kits 5451A Series is a 25/28 kV class inline splice designed for joining concentric neutral (CN) and jacketed concentric neutral (JCN) distribution class power cables. The splice is a one-piece molded design made of specially formulated, peroxide cured EPDM rubbers. Each splice is production tested on CN cable to ensure reliability. The splice is designed for use with special CI-series Inline Compression Connectors for connecting either aluminum or copper conductors. The 5451A Quick Splice II splice meets the 25 kV voltage rating requirements of IEEE 404.

Each kit makes one splice. Jacketing kit is needed for JCN cable. Connectors, unless specified, are not included in the kit, and must be ordered separately. Refer to the index to find CI, CI-840 and CI-A series connectors.

Note: CI-A series connectors are sized for 5/8 crimping die; CI-2/0 and CI-840 series connectors are sized for 840 crimping die.

Note: Cable sizes shown below are for standard insulation thickness. Final determining factor is cable insulation O.D.

Voltage: 25/28 kV

Number of Conductors: Single Conductor

Shielding Type: Concentric Neutral (CN), Jacketed Concentric Neutral (JCN)

Splice Type: Inline

Technology: Molded Rubber

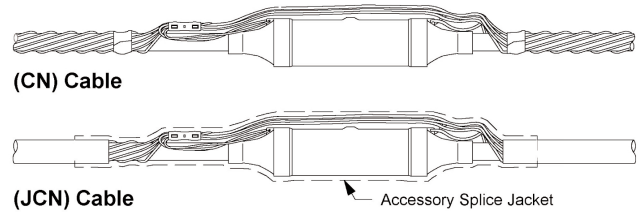

3M™ Cable Splice 5451A Series Selection—For Thick Wall (Insulation) Cable

Product Series	UPC (054007-)	Insulation O.D. Range	Conductor		Cable Insulation Thickness	Specified Connector	Case Qty.
			Stranded	Solid			
Concentric Neutral (CN) Cable, Jacketed Concentric Neutral (JCN) Cable							
5451A	49527	0.905-1.055" (23,0-26,8 mm)	2 AWG	1 AWG	295 mils	CI-2A or CI-21-840	1
			1 AWG	1/0 AWG	280 mils	CI-1A or CI-21-840	1
			1/0 AWG	—	295 mils	CI-1/0A or CI-1/0-840	1
			2/0 AWG	—	260 mils		
					280 mils		
295 mils	260 mils	CI-2/0	1				
280 mils	280 mils						
5451A-CI-1A	49529	0.905-1.055" (23,0-26,8 mm)	1 AWG	1/0 AWG	280 mils 295 mils	CI-1A	1
5451A-CI-1/0A	49530	0.905-1.055" (23,0-26,8 mm)	1/0 AWG	—	260 mils 280 mils 295 mils	CI-1/0A	1
5451A-CI-21-840	49532	0.905-1.055" (23,0-26,8 mm)	2 or 1 AWG	1 or 1/0 AWG	295 mils	CI-21-840	1
5451A-CI-1/0-840	49528	0.905-1.055" (23,0-26,8 mm)	1/0 AWG	—	260 mils 280 mils 295 mils	CI-1/0-840	1
5451A-CI-2/0	49531	0.905-1.055" (23,0-26,8 mm)	2/0 AWG	—	260 mils 280 mils	CI-2/0	1

Order No.	UPC	Case Qty.
5451A	054007-49527	1
5451A-CI-1A	054007-49529	1

25/28 kV: 3M™ Molded Rubber Splice Kits: Single Conductor (1/C)

3M™ Molded Rubber QS-II Inline CN/JCN Cable Splice Kits 5451A Series (continued)

Order No.	UPC	Case Qty.
5451A-CI-1/0A	054007-49530	1
5451A-CI-21-840	054007-49532	1
5451A-CI-1/0-840	054007-49528	1
5451A-CI-2/0	054007-49531	1

3M™ Connectors CI and CI-A Series

Meets the requirements of ANSI C119.4

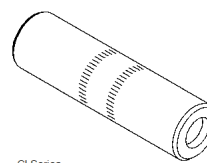

CI-Series

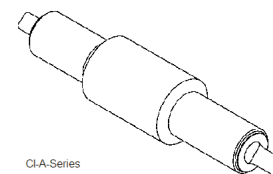

CI-A-Series

Order No.	UPC	Conductor Size	Connector O.D.	Connectors per Case
CI-22A	054007-15868	2 AWG Solid	0.910" (23 mm)	10
CI-2A	054007-00721	2 AWG Stranded, 1 AWG Solid	0.910" (23 mm)	10
CI-1A	054007-00722	2-1 AWG Stranded, 1-1/0 AWG Solid	0.910" (23 mm)	10
CI-21-840	054007-09136	2-1 AWG Stranded, 1-1/0 AWG Solid	0.910" (23 mm)	10
CI-1/0A	054007-14176	1/0 AWG Stranded	0.910" (23 mm)	10
CI-1/0-840	054007-09137	1/0 AWG Stranded	0.910" (23 mm)	10
CI-2/0	054007-11875	2/0 AWG Stranded	0.910" (23 mm)	10
CI-3/0	054007-11883	3/0 AWG Stranded	0.910" (23 mm)	10
CI-4/0	054007-11891	4/0 AWG Stranded	0.910" (23 mm)	10
CI-250	054007-11909	250 kcmil Stranded	1.125" (29 mm)	10
CI-350	054007-11925	350 kcmil Stranded	1.125" (29 mm)	10
CI-450	054007-11933	500 kcmil Compact	1.312" (33 mm)	10
CI-500	054007-25644	500 kcmil Stranded	1.312" (33 mm)	10
CI-650	054007-11941	750 kcmil Compact	1.590" (43 mm)	10
CI-750	054007-25651	750 kcmil Stranded	1.590" (43 mm)	10

25/28 kV: 3M™ Molded Rubber Cable Repair Splice Kit 5451R: Single Conductor (1/C)

3M™ Molded Rubber QS-II JCN Cable Repair Splice Kits 5451R Series

The 3M™ Molded Rubber QS-II JCN Cable Repair Splice Kit 5451R Series is a 25/28 kV class inline splice designed to serve as a cable repair for concentric neutral (CN) and jacketed concentric neutral (JCN) distribution class power cables. It is designed to replace up to 6" (15,24 cm) of damaged cable, thus virtually eliminating the need to splice in a new section of cable with two separate splices.

The splice is a one-piece molded design made of specially formulated, peroxide cured EPDM rubbers. Each splice is production tested on CN cable to ensure reliability. The splice is designed for use with the special 3M™ CIR-Series Inline Compression Connector provided, for connecting either aluminum or copper conductors. The 3M™ Molded Rubber QS-II Splice meets the 25 kV voltage rating requirements of IEEE 404. Jacketing kit is needed for JCN Cable.

Note: 3M™ Repair Connector CIR-A series connectors are sized for 5/8 crimping die; 3M™ Repair Connector CIR-840 series connectors are sized for 840 crimping die.

Note: Cable sizes shown below are for standard insulation thickness. Final determining factor is cable insulation O.D.

Voltage	25/28 kV
Number of Conductors	Single Conductor
Shielding Type	Concentric Neutral (CN), Jacketed Concentric Neutral (JCN)
Splice Type	Inline Repair
Technology	Molded Rubber

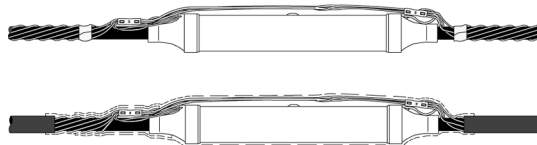
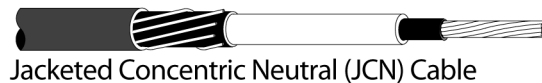

Order No.	UPC	Insulation O.D. Range	Conductor Size, Stranded	Conductor Size, Solid	Connector Included	Case Qty.
5451R-CIR-21A	054007-49479	0.870"-1.055" (22,1-26,8 mm)	2-1 AWG	1-1/0 AWG	CIR-21A	1
5451R-CIR-21-840	054007-49478	0.870"-1.055" (22,1-26,8 mm)	2-1 AWG	1-1/0 AWG	CIR-21-840	1
5451R-CIR-1/0A	054007-49476	0.870"-1.055" (22,1-26,8 mm)	1/0 AWG	-	CIR-1/0A	1
5451R-CIR-1/0-840	054007-49477	0.870"-1.055" (22,1-26,8 mm)	1/0 AWG	-	CIR-1/0-840	1

3M™ Aluminum Repair Connector CIR Series for 3M™ Molded Rubber QS-II JCN Cable Repair Splice Kit 5451R

3M™ Aluminum Repair Connector CIR Series are extra long connectors which are used to bridge gaps up to 6" (15,24 cm) when a piece of damaged cable is removed. They can be used with copper or aluminum conductors.

3M™ CIR Series Repair Connectors are specially designed for use with 3M™ Cable Repair Splice Kits. They are aluminum connectors for use on aluminum or copper cable conductors. When used with the appropriate splice kit, these connectors allow up to 6" (15,24 cm) of damaged cable conductor to be removed, virtually eliminating the need to splice in a new section of cable. CIR series connectors meet the requirements of ANSI C119.4.

Connector Base Metal	Aluminum
For use with	Aluminum or Copper Conductor

Order No.	UPC	Conductor Size, Stranded	Conductor Size, Solid	Length	Outside Diameter (O.D.)	Case Qty.
CIR-1/0-840	054007-09137	1/0 AWG	-	9.0" (228,6 mm)	0.91" (23,1 mm)	10
CIR-1/0A	054007-50226	1/0 AWG	-	9.0" (228,6 mm)	0.91" (23,1 mm)	10
CIR-21-840	054007-09136	2-1/0 AWG	1-1/0 AWG	9.0" (228,6 mm)	0.91" (23,1 mm)	10
CIR-21A	054007-50227	2-1 AWG	1-1/0 AWG	9.0" (228,6 mm)	0.91" (23,1 mm)	10

25/28 kV: 3M™ PILC Splice Kits: Single Conductor (1/C)

3M™ Cold Shrink QS-III 1/C Transition Splice Kits 5520A-1T-PILC Series

3M™ Cold Shrink QS-III 1/C Transition Splice Kits, 5520A-1T-PILC Series (which includes 5524A-1T-PILC, 5525A-1T-PILC, and 5526A-1T-PILC) are 25/28 kV class inline splices designed to transition single-conductor PILC to Poly/EPR cable and meet the 25 kV voltage class rating requirements of IEEE 404.

The splice kits include an oil barrier system based on a cold shrink tube design of specially formulated, oil-resistant polymer, and laboratory tested to nominal internal pressures of 40 psi with no oil leakage. The splice body itself is a one-piece molded design made of specially formulated silicone rubber. An EPDM rubber foldback cold shrink jacket is included for physical protection and environmental sealing.

Each kit contains sufficient material to make one splice. Connector is not provided with the kits due to customer specific application requirements. To ensure a positive oil stop, a non-tapered, sealed connector (with a solid center barrier) should be used.

Note: Cable sizes shown below are for standard insulation thickness. Final determining factor is cable insulation O.D.

Voltage	25/28 kV
Number of Conductors	Single Conductor
Shielding Type	Paper Insulated Lead Covered (PILC)
Splice Type	Inline PILC Transition
Technology	Cold Shrink

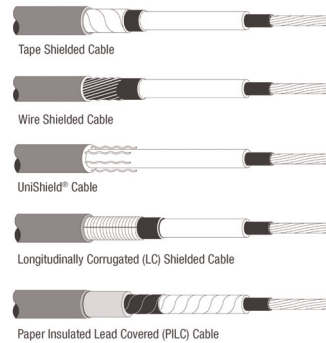

Order No.	UPC 051128-	Max. O.D. Over Lead Sheath	PILC Cable Insul. O.D.	Poly/EPR Cable Insul. O.D.	PILC Cable Conductor Size 100%	PILC Cable Conductor Size 133%	Poly/EPR Cable Conductor Size	Case Qty.
5524A-1T-PILC	-57198	1.35" (34 mm)	0.87"-1.16" (22,1-29,5 mm)	0.84"-1.32" (21,3-33,5 mm)	1 AWG-250 kcmil (50-120 mm ²)	1-2/0 AWG (50-60 mm ²)	1 AWG-250 kcmil (50-120 mm ²)	1
5525A-1T-PILC	-57199	1.79" (45 mm)	1.14"-1.57" (29,0-39,9 mm)	1.07"-1.70" (27,2-43,2 mm)	300-650 kcmil (150-325 mm ²)	250-500 kcmil (120-240 mm ²)	250-750 kcmil (120-325 mm ²)	1
5526A-1T-PILC	-57200	2.14" (54 mm)	1.49"-1.91" (37,8-48,5 mm)	1.24"-2.07" (31,5-52,6 mm)	700-1000 kcmil (400-500 mm ²)	550-1000 kcmil (300-500 mm ²)	550-1000 kcmil (300-500 mm ²)	1

35 kV Medium Voltage Splices

The following 3M products cover splicing needs for applications up to 35 kV, and promote dependable performance, stability and long life with every splice you make.



Section	Page
35 kV	222-230
3M™ Cold Shrink Splice Kits	223-227
Single Conductor (1/C)	223-225
3M™ Cold Shrink QS-III Inline CN/JCN Cable Splice Kits 5467A and 5468A Series	223
3M™ Cold Shrink QS-III Inline Shielded Cable Splice Kits 5535A and 5536A.....	224
3M™ Cold Shrink QS-III CN/JCN Cable Shield-Break Splice Kits 5467A-XB and 5468A-XB	225
Three Conductor (3/C)	226-227
3M™ Cold Shrink QS-III 3/C Armored or Non-Armored Splice Kits 5797A-MT and 5798A-MT	226
3M™ Cold Shrink MT-E Trifurcating Accessory Kit (One 3/C to Three 1/C) for 35 kV	227
3M™ Molded Rubber Splice Kits	228-229
Single Conductor (1/C)	228-229
3M™ Molded Rubber QS CN/JCN Cable Splice Kits 5432 and 5433	228
3M™ Molded Rubber QS-II CN/JCN Cable Splice Kits 5461	229
3M™ Connectors CI-A and CI-840 Series for 3M™ Molded Rubber QS Cable Splice Kits 5432 and 5461 Series	229
3M™ PILC Splice Kits	230
Single Conductor (1/C)	230
3M™ Cold Shrink QS-III 1/C Transition Splice Kits 5530A-1T-PILC Series	230

35 kV: 3M™ Cold Shrink Splice Kits: Single Conductor (1/C)

3M™ Cold Shrink QS-III Inline CN/JCN Cable Splice Kits 5467A and 5468A Series

3M™ Cold Shrink QS-III Inline CN/JCN Cable Splices 5467A, 5467A-WG, 5468A and 5468A-WG are inline splices for joining 35 kV jacketed concentric neutral (JCN) or concentric neutral (CN) power cables. It is a cold shrink design. The cold shrink splice body is a one-piece molded design made of specially formulated silicone rubbers, while the jacketing is made of EPDM rubber for its special physical properties. Each splice is high-voltage production tested to ensure reliability.

The splices can be used with standard copper (Cu) or aluminum (Al/Cu) inline compression (crimp type) connectors, and can be used for size transitions within the listed kit size range. They are designed to exceed minimum industry test standards, and have a BIL rating of 250 kV (equal to a 46 kV voltage class). The 3M™ Cold Shrink QS-III Splices 5467A, 5467A-WG, 5468A and 5468A-WG meet or exceed the 35 kV Voltage Class rating requirements of IEEE 404.

Kits can be ordered with connectors packed in the kit, or the kit and connector can be ordered as separate items. Each kit makes one splice.

Note: 5467A-WG and 5468A-WG are partially jacketed splices containing built-in bleeder wires. Additional end user materials are required to convert to full jacketing.

Note: Cable sizes shown below are for standard insulation thickness. Final determining factor is cable insulation O.D.

Voltage	35 kV
Number of Conductors	Single Conductor
Shielding Type	Concentric Neutral (CN), Jacketed Concentric Neutral (JCN)
Splice Type	Inline
Technology	Cold Shrink

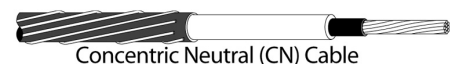

Order No.	UPC	Insulation O.D. Range	Conductor Size	Connector Included	Case Qty.
5467A	054007-43051	1.07"-1.70" (27,2-43,2 mm)	1/0 AWG-350 kcmil (60-185 mm ²)	-	1
5467A-1/0-AL	054007-43052	1.07"-1.70" (27,2-43,2 mm)	1/0 AWG	20005	1
5467A-1/0-CU	054007-43057	1.07"-1.70" (27,2-43,2 mm)	1/0 AWG	10005	1
5467A-2/0-AL	054007-43053	1.07"-1.70" (27,2-43,2 mm)	2/0 AWG	20006	1
5467A-2/0-CU	054007-43058	1.07"-1.70" (27,2-43,2 mm)	2/0 AWG	10006	1
5467A-3/0-AL	054007-43054	1.07"-1.70" (27,2-43,2 mm)	3/0 AWG	20007	1
5467A-3/0-CU	054007-43059	1.07"-1.70" (27,2-43,2 mm)	3/0 AWG	10007	1
5467A-4/0-AL	054007-43055	1.07"-1.70" (27,2-43,2 mm)	4/0 AWG	20008	1
5467A-4/0-CU	054007-43060	1.07"-1.70" (27,2-43,2 mm)	4/0 AWG	10008	1
5467A-250-AL	054007-43056	1.07"-1.70" (27,2-43,2 mm)	250 kcmil	20009	1
5467A-250-CU	054007-43061	1.07"-1.70" (27,2-43,2 mm)	250 kcmil	10009	1
5467A-350-AL	054007-04589	1.07"-1.70" (27,2-43,2 mm)	350 kcmil	20011	1
5467A-350-CU	054007-04590	1.07"-1.70" (27,2-43,2 mm)	350 kcmil	10011	1
5467A-WG	051128-53883	1.07"-1.70" (27,2-43,2 mm)	1/0 AWG-350 kcmil (60-185 mm ²)	-	1
5468A	054007-43062	1.24"-2.07" (31,5-52,6 mm)	350-1000 kcmil (185-500 mm ²)	-	1
5468A-350-AL	054007-43063	1.24"-2.07" (31,5-52,6 mm)	350 kcmil	20011	1
5468A-350-CU	054007-43067	1.24"-2.07" (31,5-52,6 mm)	350 kcmil	10011	1
5468A-500-AL	054007-43064	1.24"-2.07" (31,5-52,6 mm)	500 kcmil	20014	1
5468A-500-CU	054007-43068	1.24"-2.07" (31,5-52,6 mm)	500 kcmil	10014	1
5468A-750-AL	054007-43065	1.24"-2.07" (31,5-52,6 mm)	750 kcmil	20019	1
5468A-750-CU	054007-43069	1.24"-2.07" (31,5-52,6 mm)	750 kcmil	10019	1
5468A-1000-AL	054007-43066	1.24"-2.07" (31,5-52,6 mm)	1000 kcmil	20024	1
5468A-1000-CU	054007-43070	1.24"-2.07" (31,5-52,6 mm)	1000 kcmil	10024	1
5468A-WG	051128-53909	1.24"-2.07" (31,5-52,6 mm)	350-1000 kcmil (185-500 mm ²)	-	1

35 kV: 3M™ Cold Shrink Splice Kits: Single Conductor (1/C)

3M™ Cold Shrink QS-III Inline Shielded Cable Splice Kits 5535A and 5536A

3M™ Cold Shrink QS-III Inline Shielded Cable Splice Kits 5535A and 5536A Series are inline splices for joining 35 kV tape shield, wire shield, UniShield® or longitudinally corrugated (LC) shielded power cables. The cold shrink splice body is a one-piece molded design made of specially formulated silicone rubbers, while the jacketing is made of EPDM rubber for its special physical properties. Each splice is high-voltage production tested to ensure reliability.

The splices can be used with standard copper (Cu) or aluminum (Al/Cu) inline compression (crimp type) connectors, and can be used for size transitions within the listed kit size range. They are designed to exceed minimum industry test standards, and have a BIL rating of 250 kV (equal to a 46 kV voltage class). The 3M™ Cold Shrink QS-III Splices 5535A and 5536A meet or exceed the 35 kV Voltage Class rating requirements of IEEE 404.

Kits can be ordered with connectors packed in the kit, or the kit and connector can be ordered as separate items. Each kit makes one splice.

Note: Cable sizes shown below are for standard insulation thickness. Final determining factor is cable insulation O.D.

Voltage	35 kV
Number of Conductors	Single Conductor
Shielding Type	Tape Shield, Wire Shield, UniShield®, Longitudinally Corrugated (LC)
Splice Type	Inline
Technology	Cold Shrink

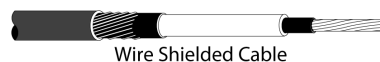
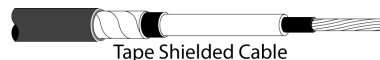

Order No.	UPC	Insulation O.D. Range	Conductor Size	Connector Included	Case Qty.
5535A	054007-43071	1.07"-1.70" (27,2-43,2 mm)	1/0 AWG-350 kcmil (60-185 mm ²)	-	1
5535A-1/0-AL	054007-43072	1.07"-1.70" (27,2-43,2 mm)	1/0 AWG	20005	1
5535A-1/0-CU	054007-43077	1.07"-1.70" (27,2-43,2 mm)	1/0 AWG	10005	1
5535A-2/0-AL	054007-43073	1.07"-1.70" (27,2-43,2 mm)	2/0 AWG	20006	1
5535A-2/0-CU	054007-43078	1.07"-1.70" (27,2-43,2 mm)	2/0 AWG	10006	1
5535A-3/0-AL	054007-43074	1.07"-1.70" (27,2-43,2 mm)	3/0 AWG	20007	1
5535A-3/0-CU	054007-43079	1.07"-1.70" (27,2-43,2 mm)	3/0 AWG	10007	1
5535A-4/0-AL	054007-43075	1.07"-1.70" (27,2-43,2 mm)	4/0 AWG	20008	1
5535A-4/0-CU	054007-43080	1.07"-1.70" (27,2-43,2 mm)	4/0 AWG	10008	1
5535A-250-AL	054007-43076	1.07"-1.70" (27,2-43,2 mm)	250 kcmil	20009	1
5535A-250-CU	054007-43081	1.07"-1.70" (27,2-43,2 mm)	250 kcmil	10009	1
5535A-350-AL	054007-04591	1.07"-1.70" (27,2-43,2 mm)	350 kcmil	20011	1
5535A-350-CU	054007-04592	1.07"-1.70" (27,2-43,2 mm)	350 kcmil	10011	1
5536A	054007-43082	1.24"-2.07" (31,5-52,6 mm)	350-1000 kcmil (185-500 mm ²)	-	1
5536A-350-AL	054007-43083	1.24"-2.07" (31,5-52,6 mm)	350 kcmil	20011	1
5536A-350-CU	054007-43087	1.24"-2.07" (31,5-52,6 mm)	350 kcmil	10011	1
5536A-500-AL	054007-43084	1.24"-2.07" (31,5-52,6 mm)	500 kcmil	20014	1
5536A-500-CU	054007-43088	1.24"-2.07" (31,5-52,6 mm)	500 kcmil	10014	1
5536A-750-AL	054007-43085	1.24"-2.07" (31,5-52,6 mm)	750 kcmil	20019	1
5536A-750-CU	054007-43089	1.24"-2.07" (31,5-52,6 mm)	750 kcmil	10019	1
5536A-1000-AL	054007-43086	1.24"-2.07" (31,5-52,6 mm)	1000 kcmil	20024	1
5536A-1000-CU	054007-43090	1.24"-2.07" (31,5-52,6 mm)	1000 kcmil	10024	1

35 kV: 3M™ Cold Shrink Splice Kits: Single Conductor (1/C)

3M™ Cold Shrink QS-III CN/JCN Cable Shield-Break Splice Kits 5467A-XB and 5468A-XB

3M™ Cold Shrink QS-III Shield-Break Splice Kits 5467A-XB and 5468A-XB Series are inline splices designed for providing a shield-break in the joining of 35 kV jacketed concentric neutral (JCN) or concentric neutral (CN) power cables. It is a cold shrink design sized to fit Type MV-90 or type MV-105 cables with copper or aluminum conductor sizes ranging from 1/0-1000 kcmil (185-500 mm²). The shield-break allows the splice to be used for shield-break and cross-bounding installations. Each splice is high-voltage production tested to ensure reliability. Meets the requirements of IEEE 404.

Each kit makes one shield-break splice.

Note: Cable sizes shown below are for standard insulation thickness. Final determining factor is cable insulation O.D.

Voltage	35 kV
Number of Conductors	Single Conductor
Shielding Type	Concentric Neutral (CN), Jacketed Concentric Neutral (JCN)
Splice Type	Inline Cross-Bond
Technology	Cold Shrink



Jacketed Concentric Neutral (JCN) Cable

Order No.	UPC	Insulation O.D. Range	Conductor Size	Typical Splice Length	Case Qty.
5467A-XB	051128-54939	1.07"-1.70" (27,2-43,2 mm)	1/0 AWG-350 kcmil (60-185 mm²)	62.0" (1574,8 mm)	1
5468A-XB	051128-54940	1.24"-2.07" (31,5-52,6 mm)	350-1000 kcmil (185-500 mm²)	66.0" (1676,4 mm)	1

35 kV: 3M™ Cold Shrink Splice Kits: Three Conductor (3/C)

3M™ Cold Shrink QS-III 3/C Armored or Non-Armored Splice Kits 5797A-MT and 5798A-MT

The 3M™ Cold Shrink QS-III 3/C Armored or Non-Armored Splice Kits 5797A-MT and 5798A-MT Series are designed for splicing 3/C, armored and non-armored, shielded power cables. The kits are rated for use on 35 kV cables with conductor sizes from 1/0 AWG-1000 kcmil (60-500 mm²). The kits are designed to be used with 3M™ Scotchlok™ Connectors 10000 and 20000 Series or other UL listed inline compression connectors that fit within the dimension limits listed in the Connector Dimensional Requirements Table on the data sheet.

The splice utilizes several technologies to accommodate the various functions of a 3/C shielded power cable: 3M™ Cold Shrink QS-III Splice Bodies, Scotch® Tapes for moisture sealing, Constant Force Springs for connecting ground braid jumpers and Armorcast for replacing the cable armor and/or jacket. The completed splice is designed for use in cable trays, weather exposed or direct burial locations. Meets the requirements of IEEE 404.

Connectors are not included in the kit and must be ordered separately.

Note: When making a trifurcating splice, the 3M™ Cold Shrink MT-E Trifurcating Accessory Kit must be used along with the splice kit.

Note: Cable sizes shown below are for standard insulation thickness. Final determining factor is cable insulation O.D.

Voltage	35 kV
Number of Conductors	Three Conductor
Shielding Type	Shielded Armored or Non-Armored
Splice Type	Inline, Trifurcating
Technology	Cold Shrink



Three-Conductor Armored, Shielded Cable

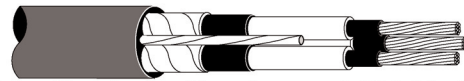

Three-Conductor Non-Armored, Shielded Cable

Order No.	UPC	Insulation O.D. Range	Conductor Size	Suggested Accessory	Case Qty.
5797A-MT	054007-43419	1.07"-1.70" (27,2-43,2 mm)	1/0 AWG-350 kcmil (60-185 mm ²)	3M™ Trifurcating Accessory for 3-C to 3 Single Conductors MT-E	1
5798A-MT	054007-43420	1.24"-2.07" (31,5-52,6 mm)	350-1000 kcmil (185-500 mm ²)	3M™ Trifurcating Accessory for 3-C to 3 Single Conductors MT-E	1

35 kV: 3M™ Cold Shrink Splice Kits: Three Conductor (3/C)

3M™ Cold Shrink MT-E Trifurcating Accessory Kit (One 3/C to Three 1/C) for 35 kV

3M™ Cold Shrink MT-E Trifurcating Accessory Kit is used to break out and seal a transition from 3/C to three 1/C.

For use with 3M™ Cold Shrink QS-III Splicing Series 5700A-MT.

Note: Cable sizes shown below are for standard insulation thickness. Final determining factor is cable insulation O.D.

Voltage: 35 kV

Number of Conductors: One 3/C to three 1/C



Selection Table

3M™ Splice 57XXA-MT	35 kV (345 mil)	Appropriate MT Transition Kit
*Typical Conductor Size Range – AWG/kcmil		
5797A-MT	1/0- 350	MT-E
5798A-MT	350	MT-E

Order No.	UPC	Single Conductor Jacket O.D.	Kits per Case
MT-E	051128-54318	1.13"-1.80" (28,7-45,7 mm)	1

35 kV: 3M™ Molded Rubber Splice Kits: Single Conductor (1/C)

3M™ Molded Rubber QS CN/JCN Cable Splice Kits 5432 and 5433

3M™ Molded Rubber QS CN/JCN Cable Splice Kits 5432 and 5433 are inline splices designed for use on 35 kV CN or JCN cable. Meets requirements of IEEE 404.

Important: On all QS kits use the primary insulation O.D. range for final ordering criteria. For copper or aluminum conductor cable, select the correct splice with connector from the table provided. Jacketing kit is needed for JCN cable.

Each kit makes one splice. Connectors are packed in kits when indicated.

Note: Cable sizes shown below are for standard insulation thickness. Final determining factor is cable insulation O.D.

Voltage	35 kV
Number of Conductors	Single Conductor
Shielding Type	Concentric Neutral (CN), Jacketed Concentric Neutral (JCN)
Splice Type	Inline
Technology	Molded Rubber



Concentric Neutral (CN) Cable



Jacketed Concentric Neutral (JCN) Cable

Order No.	UPC	Insulation O.D. Range	Conductor Size	Connector Included	Case Qty.
5432	054007-02338	1.06"-1.21" (26,9-30,7 mm)	2-1/0 AWG	-	1
5432-CI-1A	054007-08357	1.06"-1.21" (26,9-30,7 mm)	1 AWG (Stranded); 1/0 AWG (Solid)	CI-1A	1
5432-CI-1/0A	054007-31222	1.06"-1.21" (26,9-30,7 mm)	1/0 AWG (Stranded)	CI-1/0A	1
5433	054007-02339	1.12"-1.32" (28,4-33,5 mm)	3/0-4/0 AWG	-	1
5433-CI-3/0B	054007-49485	1.12"-1.32" (28,4-33,5 mm)	3/0 AWG	CI-3/0B	1
5433-CI-4/0B	054007-49486	1.12"-1.32" (28,4-33,5 mm)	4/0 AWG	CI-4/0B	1

35 kV: 3M™ Molded Rubber Splice Kits: Single Conductor (1/C)

3M™ Molded Rubber QS-II CN/JCN Cable Splice Kits 5461

3M™ Molded Rubber QS-II CN/JCN Cable Splice Kits 5461 Series are inline splices designed for use on 35 kV CN or JCN cable. Meets requirements of IEEE 404.

Important: On all QS kits use the primary insulation O.D. range for final ordering criteria. For copper or aluminum conductor cable, select the correct splice with connector from the table provided. Jacketing kit is needed for JCN cable.

Each kit makes one splice. Connectors are packed in kits when indicated.

Note: Cable sizes shown below are for standard insulation thickness. Final determining factor is cable insulation O.D.

Voltage	35 kV
Number of Conductors	Single Conductor
Shielding Type	Concentric Neutral (CN), Jacketed Concentric Neutral (JCN)
Splice Type	Inline
Technology	Molded Rubber



Concentric Neutral (CN) Cable



Jacketed Concentric Neutral (JCN) Cable

Order No.	UPC	Insulation O.D. Range	Conductor Size	Connector Included	Case Qty.
5461	054007-09129	1.00"-1.15" (25,4-29,2 mm)	1-1/0 AWG	-	1
5461-CI-1/0A	054007-09156	1.00"-1.15" (25,4-29,2 mm)	1/0 AWG	CI-1/0A	1
5461-CI-1/0-840	054007-09157	1.00"-1.15" (25,4-29,2 mm)	1/0 AWG	CI-1/0-840	1

3M™ Connectors CI-A and CI-840 Series for 3M™ Molded Rubber QS Cable Splice Kits 5432 and 5461 Series

3M™ Aluminum Connectors CI Series are for splicing applications on aluminum or copper cable conductors.

The aluminum connectors CI Series are specially designed for use with 3M™ Molded Rubber QS Cable Splice Bodies. These connectors meet the requirements of ANSI C119.4.



CI-A-Series



CI-840-Series

Barrel Style	Standard Barrel
Connector Base Material	Aluminum
For use with	Aluminum or Copper Conductors

Order No.	UPC	Stranded Conductor Size, Cu or Al	Solid Conductor Size, Cu or Al	Connector O.D.	Case Qty.
CI-1A	054007-00722	2-1 AWG	1-1/0 AWG	0.91" (23,1 mm)	10
CI-1/0A	054007-14176	1/0 AWG	-	0.91" (23,1 mm)	10
CI-1/0-840	054007-09137	1/0 AWG	-	0.91" (23,1 mm)	10
CI-3/0B	-	3/0 AWG	3/0 AWG	0.91" (23,1 mm)	10
CI-4/0B	-	4/0 AWG	4/0 AWG	0.91" (23,1 mm)	10

35 kV: 3M™ PILC Splice Kits: Single Conductor (1/C)

3M™ Cold Shrink QS-III 1/C Transition Splice Kits 5530A-1T-PILC Series

3M™ Cold Shrink QS-III 1/C Transition Splice Kits, 5530A-1T-PILC Series (which includes 5535A-1T-PILC, 5536A-1T-PILC, and 5537A-1T-PILC) are 35 kV class inline splices designed to transition single-conductor PILC to Poly/EPR cable and meet the 35 kV voltage class rating requirements of IEEE Std. 404.

The splice kits include an oil barrier system based on a cold shrink tube design of specially formulated, oil-resistant polymer, and laboratory tested to nominal internal pressures of 40 psi with no oil leakage. The splice body itself is a one-piece molded design made of specially formulated silicone rubber. An EPDM rubber foldback cold shrink jacket is included for physical protection and environmental sealing.

Each kit contains sufficient material to make one splice. Connector is not provided with the kits due to customer specific application requirements. To ensure a positive oil stop, a non-tapered, sealed connector (with a solid center barrier) should be used.

Note: Cable sizes shown below are for standard insulation thickness. Final determining factor is cable insulation O.D.

Voltage	35 kV
Number of Conductors	Single Conductor
Shielding Type	Paper Insulated Lead Covered (PILC)
Splice Type	Inline PILC Transition
Technology	Cold Shrink

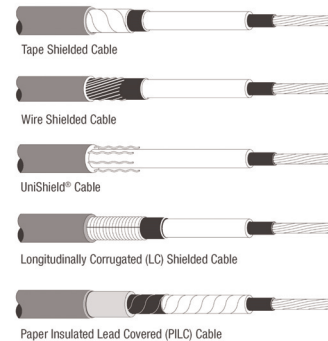

Order No.	UPC 051128-	Max. O.D. Over Lead Sheath	PILC Cable Insul. O.D.	Poly/EPR Cable Insul. O.D.	PILC Cable Conductor Size 100%	PILC Cable Conductor Size 133%	Poly/EPR Cable Conductor Size	Case Qty.
5535A-1T-PILC	-57201	1.50" (38,1 mm)	1.10"-1.31" (27,9-33,3 mm)	1.07"-1.70" (27,2-43,2 mm)	1/0-4/0 AWG (60-95 mm ²)	1/0-2/0 AWG (60 mm ²)	1/0 AWG-350 kcmil (60-185 mm ²)	1
5536A-1T-PILC	-57202	1.88" (47,8 mm)	1.32"-1.67" (33,5-42,4 mm)	1.11"-1.70" (28,2-43,2 mm)	250-450 kcmil (150-200 mm ²)	3/0 AWG-450 kcmil (95-200 mm ²)	3/0 AWG-500 kcmil (95-240 mm ²)	1
5537A-1T-PILC	-57203	2.23" (56,6 mm)	1.57"-2.0" (39,9-50,8 mm)	1.24"-2.07" (31,5-52,6 mm)	500-1000 kcmil (240-500 mm ²)	500-900 kcmil (240-400 mm ²)	500-1000 kcmil (240-500 mm ²)	1

46 kV Medium Voltage Splices

The following 3M products cover splicing needs for applications up to 46 kV, and promote dependable performance, stability and long life with every splice you make.



Section	Page
46 kV	231-232
3M™ Cold Shrink Splice Kits	232
Single Conductor (1/C)	232
3M™ Cold Shrink QS-III Inline Shielded Splice Kit 5545A	232

46 kV: 3M™ Cold Shrink Splice Kits: Single Conductor (1/C)

3M™ Cold Shrink QS-III Inline Shielded Splice Kit 5545A

3M™ Cold Shrink QS-III Splice Kit 5545A Series are inline splices for joining 46 kV Tape, Wire, LC, and UniShield® power cables. The cold shrink splice body is a one-piece molded design made of specially formulated silicone rubbers, while the jacketing is made of EPDM rubber for its special physical properties. Each splice is high-voltage production tested to ensure reliability.

The splice can be used with standard copper (Cu) or aluminum (Al/Cu) inline compression (crimp type) connectors, and can be used for size transitions within the listed kit size range. The kit is designed to exceed minimum industry test standards, and has a BIL rating of 250 kV. The 3M™ Cold Shrink QS-III Splice 5545A meets or exceeds the 46 kV Voltage Class rating requirements of IEEE 404.

Each kit makes one splice. Connectors are not included in the kit and must be ordered separately.

Note: Cable sizes shown below are for standard insulation thickness. Final determining factor is cable insulation O.D.

Voltage	46 kV
Number of Conductors	Single Conductor
Shielding Type	Tape Shield, Wire Shield, UniShield®, Longitudinally Corrugated (LC)
Splice Type	Inline
Technology	Cold Shrink

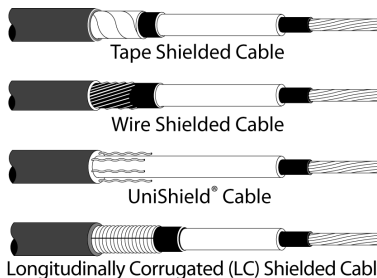

Order No.	UPC	Insulation O.D. Range	Conductor Size	Connector	Case Qty.
5545A	051128-55089	1.24"-2.07" (31,5-52,6 mm)	4/0-1000 kcmil* (120-500 mm²) *4/0 AWG - 250 kcmil cable may be used with aluminum connectors only - do not use 4/0 AWG or 250 kcmil copper connector.	-	1



Компания «ЭлектроПласт» предлагает заключение долгосрочных отношений при поставках импортных электронных компонентов на взаимовыгодных условиях!

Наши преимущества:

- Оперативные поставки широкого спектра электронных компонентов отечественного и импортного производства напрямую от производителей и с крупнейших мировых складов;
- Поставка более 17-ти миллионов наименований электронных компонентов;
- Поставка сложных, дефицитных, либо снятых с производства позиций;
- Оперативные сроки поставки под заказ (от 5 рабочих дней);
- Экспресс доставка в любую точку России;
- Техническая поддержка проекта, помощь в подборе аналогов, поставка прототипов;
- Система менеджмента качества сертифицирована по Международному стандарту ISO 9001;
- Лицензия ФСБ на осуществление работ с использованием сведений, составляющих государственную тайну;
- Поставка специализированных компонентов (Xilinx, Altera, Analog Devices, Intersil, Interpoint, Microsemi, Aeroflex, Peregrine, Syfer, Eurofarad, Texas Instrument, Miteq, Cobham, E2V, MA-COM, Hittite, Mini-Circuits, General Dynamics и др.);

Помимо этого, одним из направлений компании «ЭлектроПласт» является направление «Источники питания». Мы предлагаем Вам помощь Конструкторского отдела:

- Подбор оптимального решения, техническое обоснование при выборе компонента;
- Подбор аналогов;
- Консультации по применению компонента;
- Поставка образцов и прототипов;
- Техническая поддержка проекта;
- Защита от снятия компонента с производства.



Как с нами связаться

Телефон: 8 (812) 309 58 32 (многоканальный)

Факс: 8 (812) 320-02-42

Электронная почта: org@eplast1.ru

Адрес: 198099, г. Санкт-Петербург, ул. Калинина, дом 2, корпус 4, литера А.