

# Accessories & Hardware

## Contents

---

Part Number	Page
AT001s .....	Y4
AT100s .....	Y6
AT200s .....	Y7
AT400s .....	Y9
AT500s .....	Y14
AT600s .....	Y17
AT700s .....	Y19
AT2100s .....	Y19
AT3000s .....	Y20
AT4000s .....	Y23
AT4100s .....	Y27
AT9000s .....	Y34

---

Toggle

Rockers

Pushbuttons

Illuminated PB

Programmable

Keylocks

Rotaries

Slides

Tactiles

Tilt

Touch

Indicators

Accessories

Supplement

Y

## Color Codes

<b>A</b> Black	<b>F</b> Green
<b>B</b> White	<b>G</b> Blue
<b>C</b> Red	<b>H</b> Gray
<b>D</b> Amber	<b>J</b> Clear
<b>E</b> Yellow	<b>S</b> Metallic Silver

## Hardware Threading

Many hardware pieces are available in both metric and inch threading, and in such cases **M** (metric) and **H** (inch) are noted in the descriptions. The customer must select threading by placing an M or H after the basic AT part number. If the hardware is available only in metric or inch, no code is used in the description; threading is designated on the drawing.

# Accessories & Hardware

Toggles

Rockers

Pushbuttons

Illuminated PB

Programmable

Keylocks

Rotaries

Slides

Tactiles

Tilt

Touch

Indicators

Accessories

Supplement

## AT010s~ AT090s

\* Available in Americas only

**\* AT016**  
16mm Hex Mounting Nut  
Steel  
Series: CKM

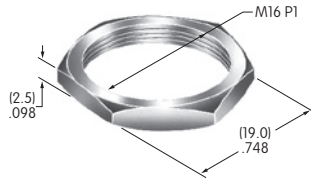

**\* AT019**  
19mm Hex Mounting Nut  
Brass with nickel plating  
Series: CKL

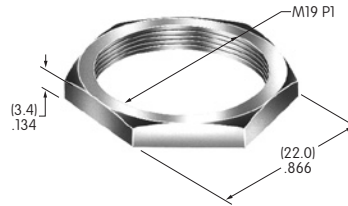

**\* AT050**  
Knurled Nut  
Brass with nickel plating  
Series: SB40

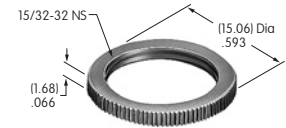

**\* AT055**  
Crossover Guard  
Polypropylene  
Series: KB

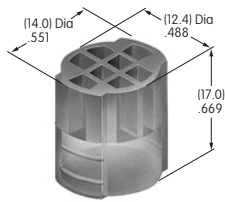

**AT056**  
Dress Cap Nut  
Brass with chrome plating  
Series: M P S

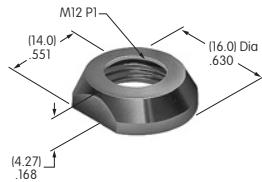

**AT056T**  
Threaded Through Dress Nut  
Brass with chrome plating  
Series: M P S

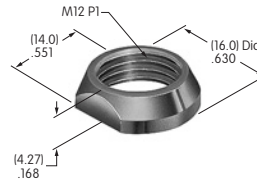

**\* AT057**  
Mounting Nut  
Brass with zinc plating,  
chromate finish  
Series: KB

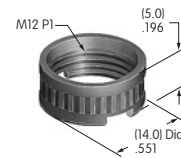

**\* AT062**  
.250" Wide Rocker  
Polyamide  
Colors: A B C  
Series: A

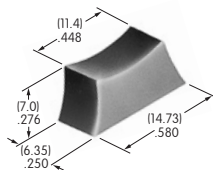

**\* AT063**  
Gasket  
Nitrile butadiene rubber  
Color: A  
Series: B Threaded Bushing

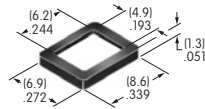

**AT064-1**  
Panel Frame for Rocker & Paddle .365" Wide  
Polyamide  
Color: A  
Series: M

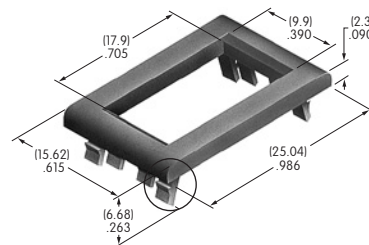

**AT064-2**  
Panel Frame for Rocker & Paddle .365" Wide  
Polyamide  
Color: A  
Series: M

AT064-1 accommodates  
panel thickness  
1.2 ~ 2.3mm  
(.047 ~ .090")



AT064-2 accommodates  
panel thickness  
1.57 ~ 3.18mm  
(.062 ~ .125")



Color Codes: A Black B White C Red D Amber E Yellow F Green G Blue H Gray J Clear

# Accessories & Hardware

**AT065-1**  
**Panel Frame for Rocker & Paddle .450" Wide**  
 Polyamide  
 Color: A  
 Series: M

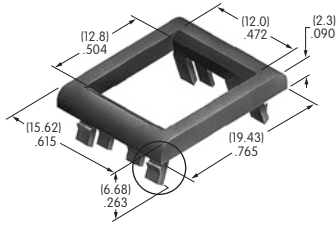

AT065-1 accommodates  
 panel thickness  
 1.2 ~ 2.3mm  
 (.047 ~ .090")



**AT065-2**  
**Panel Frame for Rocker & Paddle .450" Wide**  
 Polyamide  
 Color: A  
 Series: M

**\* AT066**  
**.300" Wide Rocker**  
 Polyamide  
 Color: A B C  
 Series: A

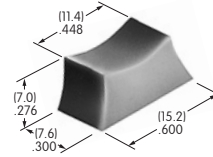

AT065-2 accommodates  
 panel thickness  
 1.57 ~ 3.18mm  
 (.062 ~ .125")



**\* AT070**  
**LED for AT208 Bezel**  
 Colors: C F  
 Series: EB M MB24

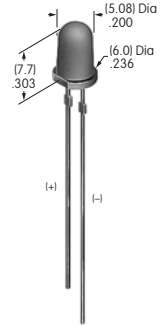

**\* AT073**  
**Mounting Nut**  
 Brass with nickel plating  
 Series: HB

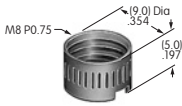

**\* AT074**  
**Mounting Nut for LB Panel Seal**  
 Brass with chrome  
 Series: LB

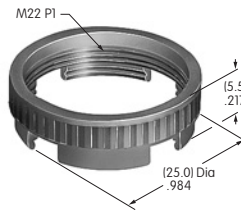

**\* AT075**  
**O-ring for LB Panel Seal**  
 Nitrile butadiene rubber  
 Series: LB

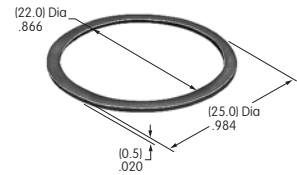

**AT080**  
**Screw Adaptor for AT452 & AT454**  
 Brass  
 Series: MB20 SCB

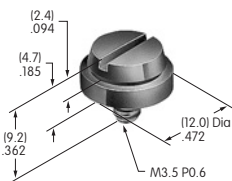

**AT089**  
**O-ring for YB Panel Seal**  
 Nitrile butadiene rubber  
 Series: YB

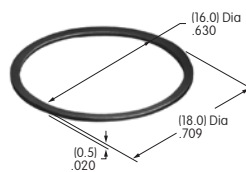

**\* AT092**  
**Knurled Mounting Nut**  
 Glass fiber reinforced PBT  
 Series: YB YB2

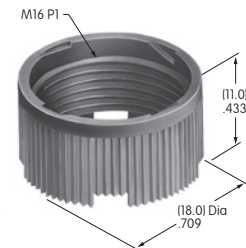

Color Codes: A Black B White C Red D Amber E Yellow F Green G Blue H Gray J Clear

# Accessories & Hardware

Toggles

Rockers

Pushbuttons

Illuminated PB

Programmable

Keylocks

Rotaries

Slides

Tactiles

Tilt

Touch

Indicators

Accessories

Supplement

**\* AT094**

**PC Adaptor**

Holder: Polypropylene  
 Spring: Spring steel with nickel plating  
 PC Pins: Brass with nickel plating  
 Series: DSA01

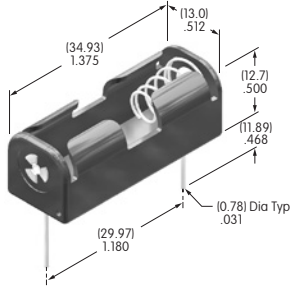

**\* AT097** ← **NEW**

**JST Connector for OLED Rocker**

JST Part No. BM12B-SURS  
 PCB Mount  
 Series: SmartSwitch

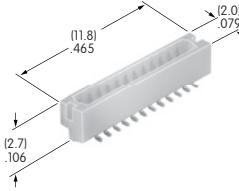

## AT100s

**AT105**

**Cap Removal Tool**

Stainless steel  
 Series: HB KB LB UB YB

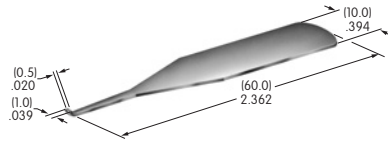

**AT106**

**Socket Wrench**

Aluminum with black alumite finish  
 Series: YB YB2

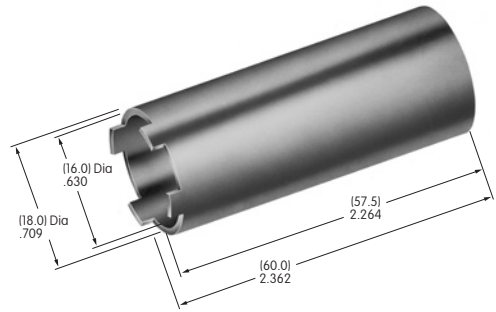

**AT107**

**Lamp Extractor**

Polyvinyl chloride  
 Series: KB LW MLW YB

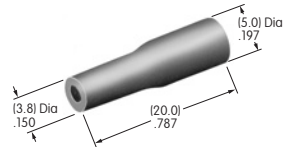

**AT108**

**Socket Wrench**

Aluminum with black alumite finish  
 Series: KB

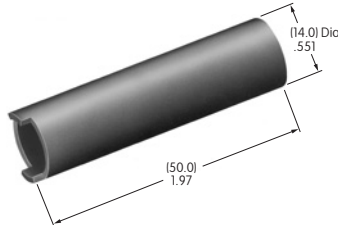

**AT109**

**Cap Extractor**

Stainless steel  
 Series: HB KB LB UB YB

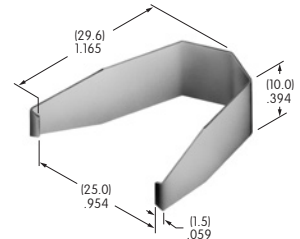

**Color Codes:** A Black B White C Red D Amber E Yellow F Green G Blue H Gray J Clear

# Accessories & Hardware

**AT110**  
**Socket Wrench**  
 Brass  
 Series: HB

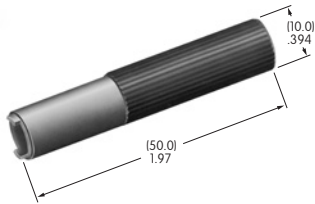

**AT111**  
**Lamping Tool**  
 Stainless steel  
 Series: HB KB YB

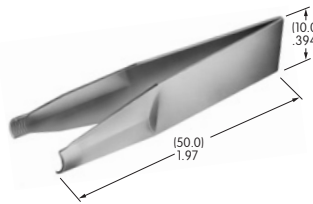

**AT112**  
**Socket Wrench**  
 Brass with nickel plating  
 Series: LB

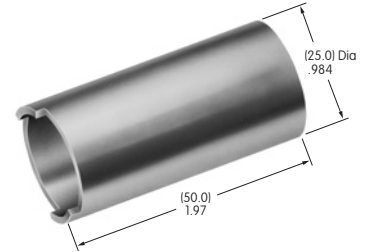

## AT200s

**AT201**  
**ON-OFF Plate for 12mm Threaded Bushing**  
 Brass with nickel plating  
 Series: M P S

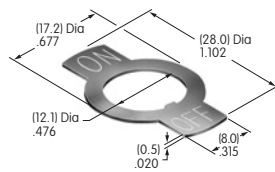

**AT202**  
**ON-OFF Plate for 12mm Threaded Bushing**  
 Aluminum  
 Colors: Red & black enamel  
 Series: M P S

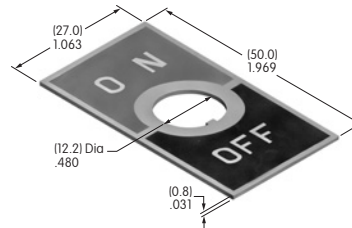

**AT204**  
**Bezel**  
 Polycarbonate  
 Colors: A B C D E F G H  
 Series: MLW

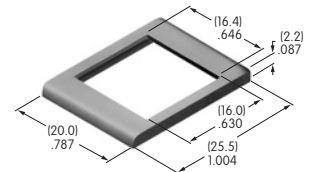

**AT206**  
**Bezel**  
 Polycarbonate  
 Colors: A B C D E F G H  
 Series: LW

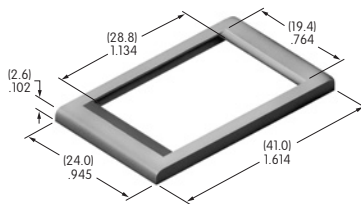

**AT207**  
**Bezel**  
 Polycarbonate  
 Colors: A B C E F G H  
 Series: EB MB24 MB25

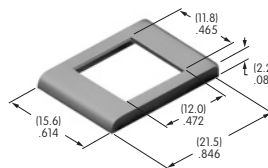

**AT208**  
**Bezel for AT070 LED**  
 Polycarbonate  
 Color: A  
 Series: EB M MB24 MB25

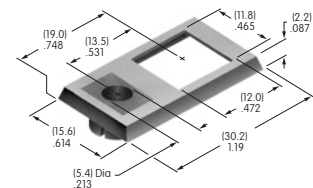

Color Codes: A Black B White C Red D Amber E Yellow F Green G Blue H Gray J Clear

# Accessories & Hardware

Toggle

Rockers

Pushbuttons

Illuminated PB

Programmable

Keylocks

Rotaries

Slides

Tactiles

Tilt

Touch

Indicators

Accessories

Supplement

**AT209**  
**ON-OFF Plate for 6mm Threaded Bushing**  
 Brass with nickel plating  
 Series: M P

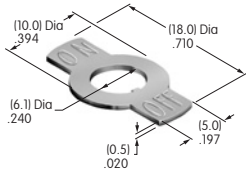

**AT210**  
**ON-OFF Plate for 6mm Threaded Bushing**  
 Aluminum  
 Colors: Red & black ink  
 Series: M P

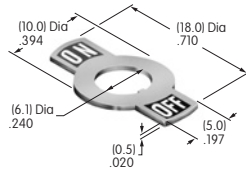

**AT211**  
**ON-OFF Plate for 6mm Threaded Bushing**  
 Aluminum  
 Colors: Red & black enamel  
 Series: M P

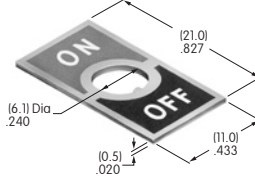

**AT212**  
**Bezel for 2 AT617 LEDs**  
 Polycarbonate  
 Color: A  
 Series: EB M MB24 MB25

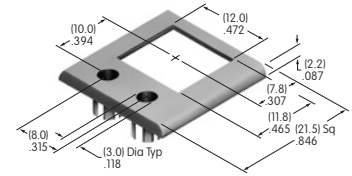

**AT213**  
**Bezel for 2 AT618 LEDs**  
 Polycarbonate  
 Color: A  
 Series: EB M MB24 MB25

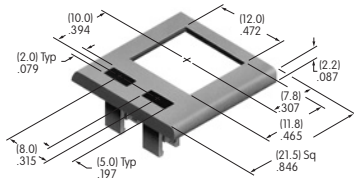

**AT214**  
**ON-OFF Plate for 12mm Threaded Bushing**  
 Aluminum  
 Colors: Red & black ink  
 Series: M P S

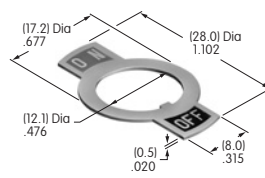

**AT215**  
**ON-OFF Plate for 12mm Threaded Bushing**  
 Aluminum  
 Colors: Red & black enamel  
 Series: M P S

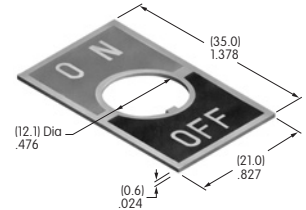

**AT217**  
**Barrier**  
 Polyamide  
 Colors: A B H  
 Series: JWM

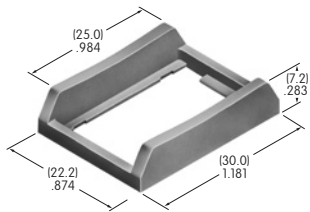

**AT218**  
**Barrier**  
 Polyamide  
 Colors: A B H  
 Series: JWJ

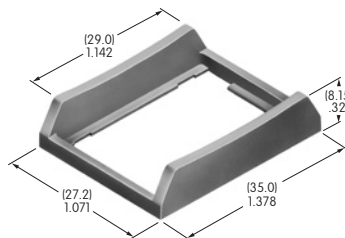

**AT219**  
**Barrier**  
 Polyamide  
 Colors: A  
 Series: JWS

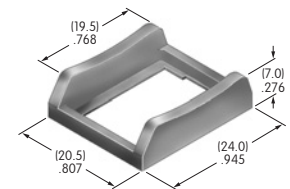

**Color Codes:** A Black B White C Red D Amber E Yellow F Green G Blue H Gray J Clear





# Accessories & Hardware

Toggle

Rockers

Pushbuttons

Illuminated PB

Programmable

Keylocks

Rotaries

Slides

Tactiles

Tilt

Touch

Indicators

Accessories

Supplement

## AT406

**Bat Lever Cap**  
Polyvinyl chloride  
Colors: A B C E F G  
Series: M P S

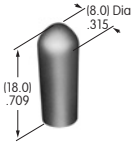

## AT407

**.394" Diameter Screw-on Cap**  
PBT  
Colors: A B C E F G H  
Series: MB20

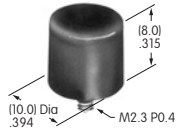

## AT412

**.748" Diameter Screw-on Cap**  
Polystyrene  
Colors: A B C F  
Series: MB20 SCB WB

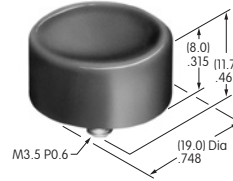

## AT413

**.315" Diameter Screw-on Cap**  
PBT  
Colors: A B C E F G H  
Series: MB20

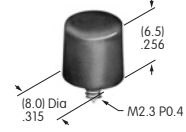

## AT414

**.520" Diameter Screw-on Cap**  
PBT  
Colors: A B C D E F G H  
Series: MB20 SB SCB WB

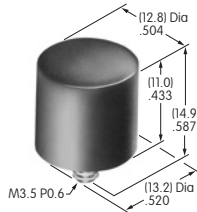

## AT415

**Bat Lever Cap**  
Polyethylene  
Colors: A B C E F G  
Series: D2 M

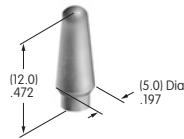

## AT416

**Lamp Cover for AT602**  
Silicon rubber  
Colors: C D F  
Series: LW

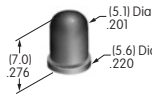

## AT420

**Rocker**  
Polycarbonate  
Colors: B J  
Series: LW

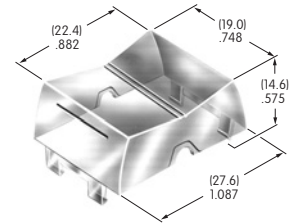

## AT421

**Filter for AT420**  
Polycarbonate  
Colors: B C D E F G  
Series: LW

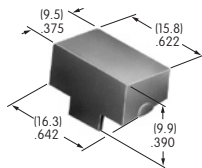

## AT422

**Slip-on Cap**  
Polyethylene  
Colors: A B C E F G  
Series: SB40

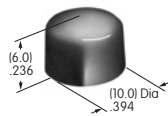

## AT426

**Solid Color Paddle**  
Polycarbonate  
Colors: A B C D E F G  
Series: MLW

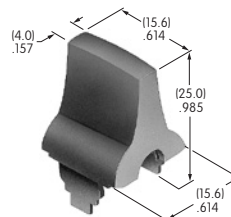

## AT427

**Cap for Locking Lever (code L)**  
Brass with bright nickel plating (supplied with switch)  
Anodized aluminum  
Colors: A C G  
Series: D2 M



**Color Codes:** A Black B White C Red D Amber E Yellow F Green G Blue H Gray J Clear

# Accessories & Hardware

## AT428 (M-metric H-inch)

**Splashproof Boot**  
Silicone rubber  
Color: A  
Series: D2 M P

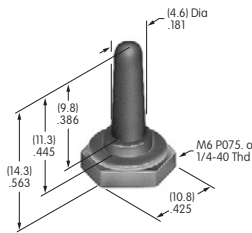

## AT429

**Indicator Cap**  
Polycarbonate  
Colors: B C D E F G  
Series: P01

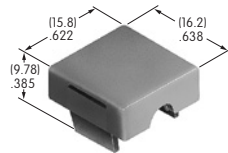

## AT431

**Large Rotary Knob**  
Phenolic resin  
Color: A  
Series: HS PS TS

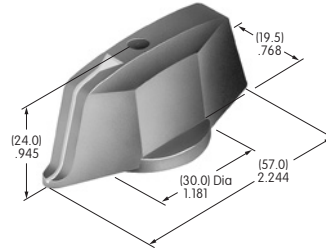

## AT432

**Small Rotary Knob**  
Phenolic resin  
Color: A  
Series: HS PS TS

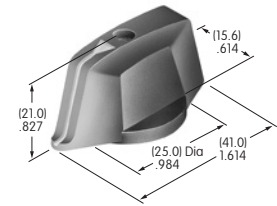

## AT433

**Knob for Miniature Rotaries**  
Polyacetal  
Color: A  
Series: FR01 MR

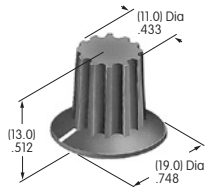

## AT434

**Bat Lever Cap**  
Polyvinyl chloride  
Colors: A B C E F G  
Series: M

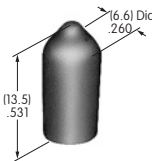

## AT435

**Screw-on Cap**  
Brass with chrome plating  
Series: SB265

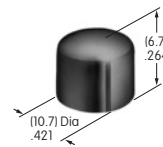

## AT438

**Design Rocker**  
Polycarbonate  
Colors: B C D F G  
Series: MLW

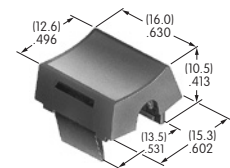

## AT442

**.394" Diameter Snap-on Cap**  
Polycarbonate  
Colors: A B C E F G H  
Series: DB EB M2B MB20 MB25

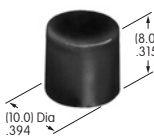

## AT443

**.315" Diameter Snap-on Cap**  
Polycarbonate  
Colors: A B C E F G H  
Series: DB EB M2B MB20 MB25

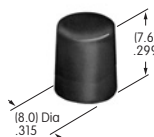

## AT444

**Bat Lever Conical Cap**  
Polyethylene  
Colors: A B C E F G  
Series: D2 M M2T

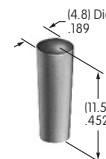

## AT445

**Cap for Color Tipped Cone Toggle**  
Polycarbonate  
Colors: A B C E F G  
Series: M

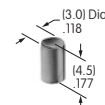

Color Codes: A Black B White C Red D Amber E Yellow F Green G Blue H Gray J Clear

# Accessories & Hardware

Toggles

Rockers

Pushbuttons

Illuminated PB

Programmable

Keylocks

Rotaries

Slides

Tactiles

Tilt

Touch

Indicators

Accessories

Supplement

**AT452**  
**Rectangular Insert**  
 Polycarbonate  
 Colors: A B C F G H  
 Series: MB20 SCB  
 Used with Screw Adaptor AT080

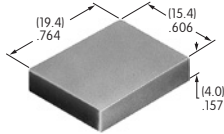

**AT453**  
**Rectangular Shroud**  
 Polycarbonate  
 Colors: A B H  
 Series: MB20 SCB

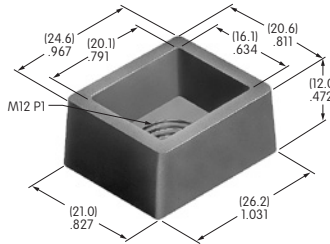

**AT454**  
**Round Insert**  
 Polycarbonate  
 Colors: A B C F G H  
 Series: MB20 SCB  
 Used with Screw Adaptor AT080



**AT455**  
**Round Shroud**  
 Polycarbonate  
 Colors: A B H  
 Series: MB20 SCB

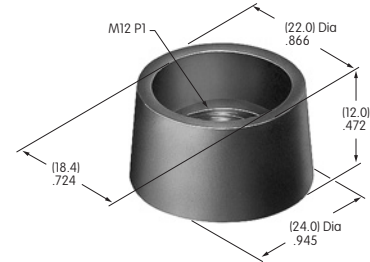

**AT460**  
**Cap for Color Capped Cone Toggle**  
 Polyethylene  
 Colors: A B C E F G  
 Series: M

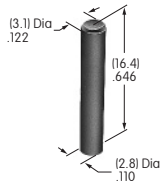

**AT465**  
**.453" Square Cap**  
 Polycarbonate  
 Colors: A B C E F G H  
 Series: EB MB24 MB25

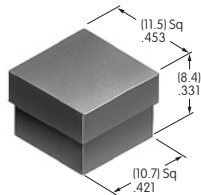

**AT466**  
**.453" False Illuminated Rocker**  
 Polycarbonate  
 Cap Color: A  
 Window Color: B/C  
 Series: M

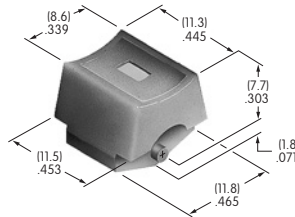

**AT467**  
**Short Paddle**  
 Polyamide  
 Colors: A B C E F G H  
 Series: A

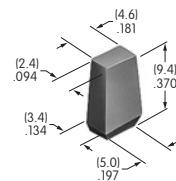

**AT468**  
**Long Paddle**  
 Polyamide  
 Colors: A B C E F G H  
 Series: A

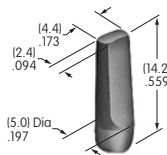

**AT469**  
**.260" Wide Rocker**  
 Polyamide  
 Colors: A B C E F G H  
 Series: A

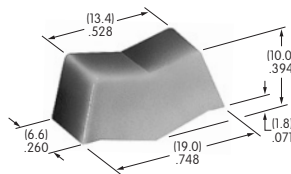

**AT475**  
**.201" Diameter Cap**  
 Polyamide  
 Colors: A B C  
 Series: AB BB FB M2B MB24

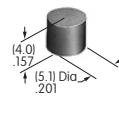

**AT476**  
**Square Solid Colored Cap**  
 Polycarbonate  
 Colors: BJ CJ EJ FJ GJ  
 Series: LB

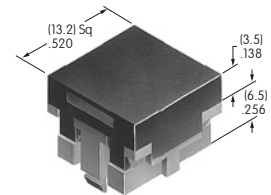

**Color Codes:** A Black B White C Red D Amber E Yellow F Green G Blue H Gray J Clear

# Accessories & Hardware

## AT477

**Square Colored Insert Cap**  
 Polycarbonate  
 Colors: JB JC JE JF JG  
 Series: LB

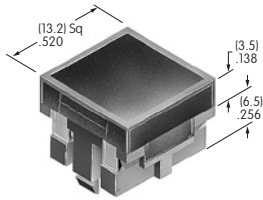

## AT480

**Square Spot Illuminated Cap**  
 Polycarbonate  
 Cap Colors: A B C F  
 LED Colors: C D F CF  
 Series: LB

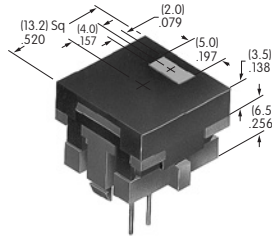

## AT484

**Square Nonilluminated Cap**  
 Polycarbonate  
 Colors: A B C E F G H  
 Series: LB

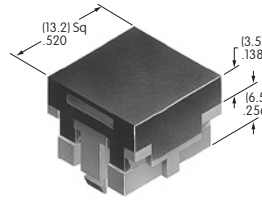

## AT485

**Square Solid Colored Cap**  
 Polycarbonate  
 Colors: A BB CB CC EB  
 FB FF GB GG  
 Series: KB

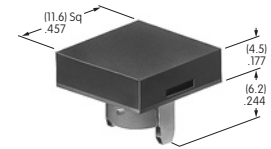

## AT486

**Round Solid Colored Cap**  
 Polycarbonate  
 Colors: A BB CB CC EB  
 FB FF GB GG  
 Series: KB



## AT487

**Square Colored Insert Cap**  
 Polycarbonate  
 Colors: JB JC JE JF JG  
 Series: KB

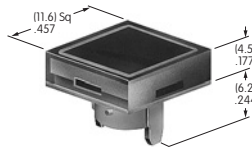

## AT488

**Round Colored Insert Cap**  
 Polycarbonate  
 Colors: JB JC JE JF JG  
 Series: KB



## AT494

**Protective Guard**  
 Cover: Polycarbonate  
 Base: Polyamide  
 Series: KB

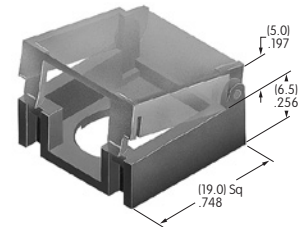

## AT495

**Dust Cover**  
 Lid: Polyvinyl chloride  
 Base: Polyamide  
 Series: KB

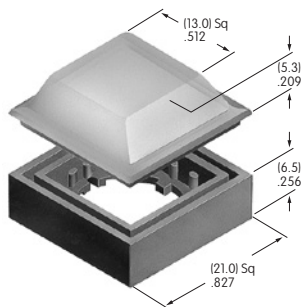

## AT496

**.295" Diameter Cap**  
 Polyamide  
 Colors: A B C  
 Series: AB BB FB M2B MB24

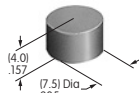

## AT497

**End Barrier**  
 Polyamide  
 Color: A  
 Series: LB

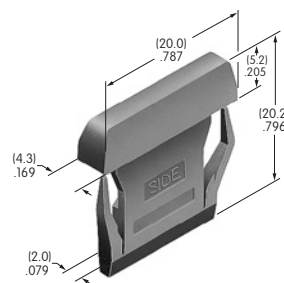

## AT498

**Center Barrier**  
 Polyamide  
 Color: A  
 Series: LB

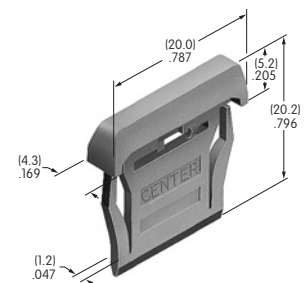

Color Codes: A Black B White C Red D Amber E Yellow F Green G Blue H Gray J Clear

# Accessories & Hardware

Toggle

Rockers

Pushbuttons

Illuminated PB

Programmable

Keylocks

Rotaries

Slides

Tactiles

Tilt

Touch

Indicators

Accessories

Supplement

**AT499**  
**Protective Guard for Square**  
 Cover: Polycarbonate  
 Base: Polyamide  
 Series: LB

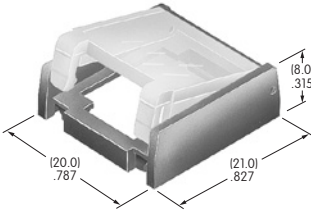

**AT500s**

**AT501 (M-metric H-inch)**  
**Knurled Face Nut**  
 Brass with chrome plating  
 Series: D2 DB EB M MB20  
 MB24 P

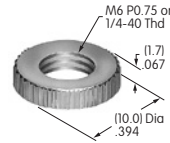

**AT503 (M-metric H-inch)**  
**Hex Face Nut**  
 Brass with chrome plating  
 Series: M P S SB WB WT

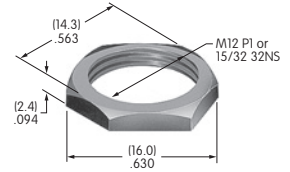

**AT504M**  
**Knurled Face Nut**  
 Brass with chrome plating  
 Series: M P S SB SCB  
 WB WT

**AT506M**  
**Locking Ring**  
 Steel with zinc/chromate  
 Series: M MB20 P S SB

**AT507 (M-metric H-inch)**  
**Locking Ring**  
 Steel with zinc/chromate  
 Series: D2 DB EB M MB20  
 MB24 MB25 MR P

**AT508**  
**Internal Tooth Lockwasher**  
 Steel with zinc/chromate  
 Series: M P S SB SCB  
 SK TL WB WT

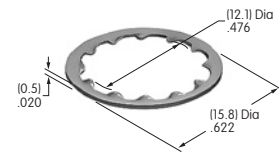
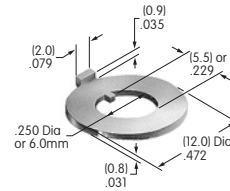
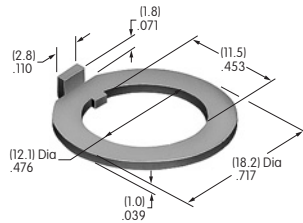
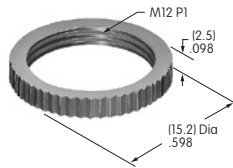

**AT509**  
**Internal Tooth Lockwasher**  
 Steel with zinc/chromate  
 Series: D2 DB EB FR01 M  
 MB25 MR P S SB

**AT512 (M-metric H-inch)**  
**Conical Nut**  
 Brass with chrome plating  
 Series: EB MB20

**AT512C (M-metric H-inch)**  
**Conical Nut**  
 Brass with chrome plating  
 Series: EB MB20

**AT513H**  
**Hex Nut**  
 Brass with nickel plating  
 Series: M MB20 MB24

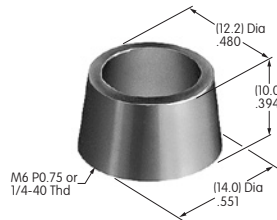
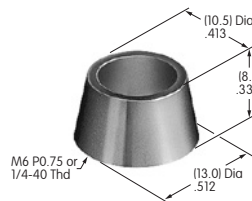
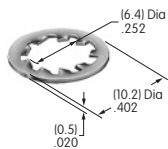

**Color Codes:** A Black B White C Red D Amber E Yellow F Green G Blue H Gray J Clear

# Accessories & Hardware

## AT513M

### Hex Nut

Brass with nickel plating  
Series: B D2 DB EB FR01 M  
MB20 MB25 MR P

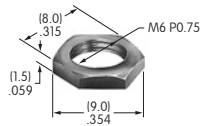

## AT515 (M-metric H-inch)

### Locking Ring for D Flat Bushing

Steel with zinc/chromate  
Series: FR01 M MB24

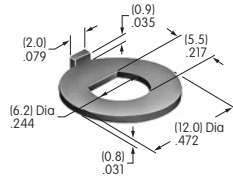

## AT516

### O-ring

Nitrile butadiene rubber  
Series: M MB20

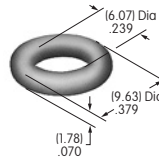

## AT518

### Locking Ring

Steel with zinc/chromate  
Series: HS PS TS

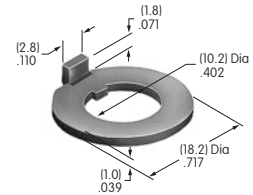

## AT520

### Split Lockwasher

Steel with zinc/chromate  
Series: HS PS TS

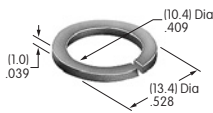

## AT526

### Hex Mounting Nut

Steel with nickel plating  
Series: HS PS TS

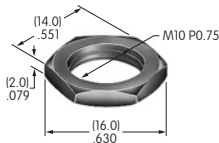

## AT527 (M-metric H-inch)

### Hex Mounting Nut

Steel with nickel plating  
Series: M P S SB SCB  
SK TL

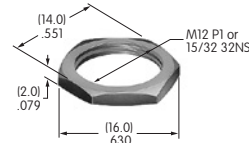

## AT527MA

### Black Hex Face Nut

Steel with black chrome plating  
Series: TL

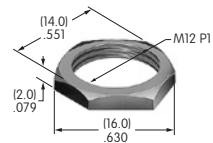

## AT529

### Mounter for Square Cap

Stainless steel frame  
GFR PBT spacer  
Series: EB

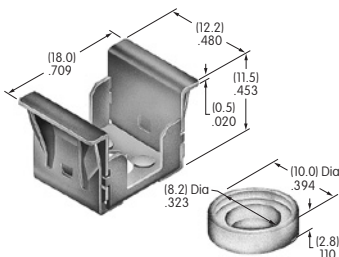

## AT530

### Panel Mount for Single Pole

Polyamide & polyacetel  
Colors: A B C E F G H  
Series: A AB

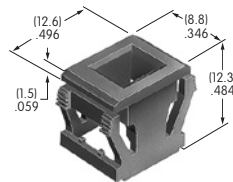

## AT531

### Panel Mount for Single or Double Pole

Polyamide & polyacetel  
Colors: A B C E F G H  
Series: A AB

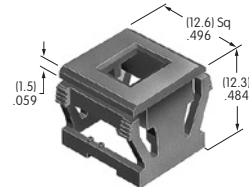

## AT532 (M-metric H-inch)

### Dress Cap Nut

Brass with nickel plating  
Series: EB M MB20 MB24 P

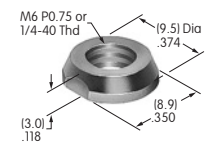

Color Codes: A Black B White C Red D Amber E Yellow F Green G Blue H Gray J Clear

# Accessories & Hardware

Toggle

Rockers

Pushbuttons

Illuminated PB

Programmable

Keylocks

Rotaries

Slides

Tactiles

Tilt

Touch

Indicators

Accessories

Supplement

**AT532T (M-metric H-inch)**  
**Threaded Through Dress Nut**  
 Brass with nickel plating  
 Series: EB M MB20 MB24 P

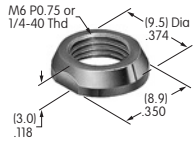

**AT533T (M-metric H-inch)**  
**Threaded Through Dress Nut**  
 Brass with nickel plating  
 Series: EB M MB20 MB24 P

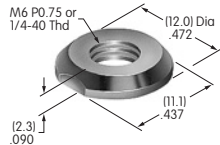

**AT535**  
**Rubber Ring for MR Panel Seal**  
 Nitrile butadiene rubber  
 Series: MRB MRK

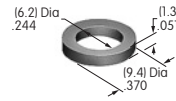

**AT536**  
**Hex Nut**  
 Brass with nickel plating  
 Series: FB

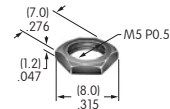

**AT537**  
**O-ring**  
 Nitrile butadiene rubber  
 Series: S

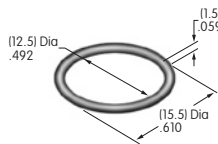

**AT541**  
**O-ring for Panel Seal with AT4115**  
 Nitrile butadiene rubber  
 Series: YB

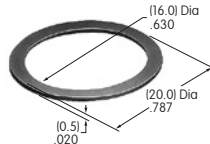

**AT542**  
**Coupler for LCD 36 x 24 Pushbutton**  
 PBT  
 Series: SmartSwitch

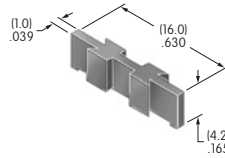

**AT543**  
**Support Bracket**  
 Steel with tin plating  
 Series: MRK

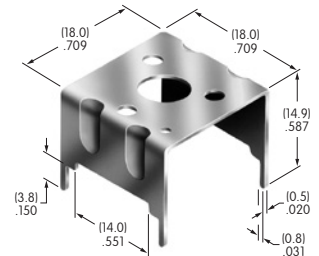

**AT545**  
**Locking Ring**  
 Steel with zinc/chromate  
 Series: MRA MRB MRK

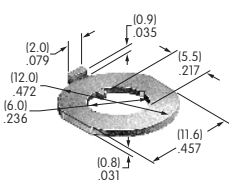

**AT546**  
**Mounting Bracket for Block Mounting**  
 Phosphor bronze with tin plating  
 Series: GB2

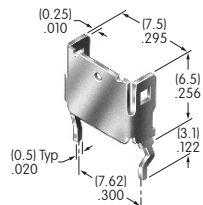

**AT547**  
**Mounter for AT4140**  
 Polyamide  
 Color: A  
 Series: JB

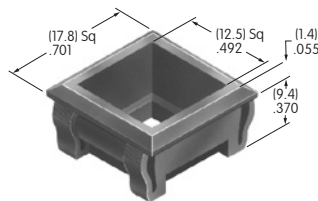

**AT548**  
**Panel Mount Housing for LCD 36 x 24 Pushbutton (not for Compact SmartSwitch)**  
 Polyamide  
 Color: A  
 Series: SmartSwitch

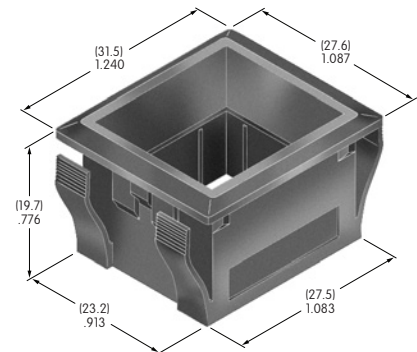

**Color Codes:** A Black B White C Red D Amber E Yellow F Green G Blue H Gray J Clear

# Accessories & Hardware

## AT600s

**AT602**  
Incandescent Lamp  
Volts: 6 12 18 24 28  
Series: LW MLW  
T-1 1/2 Pilot Slide Base

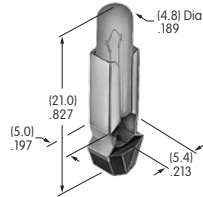

**AT602N**  
Neon Lamp  
Volts: 110  
Series: LW MLW  
T-1 1/2 Pilot Slide Base

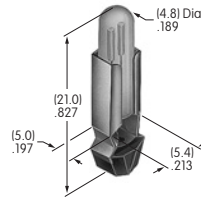

**AT607**  
Incandescent Lamp  
Volts: 5 12  
Series: LB  
T-1 Bi-pin

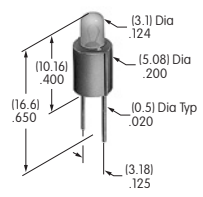

**AT607N**  
Neon Lamp  
Volts: 110  
Series: LB  
T-1 Bi-pin

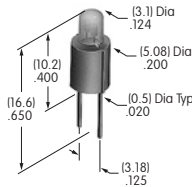

**AT611**  
Incandescent Lamp  
Volts: 5 12  
Series: KB YB  
T-1 Bi-pin

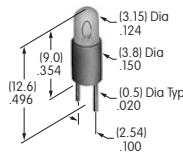

**AT615**  
Neon Lamp  
Volts: 110  
Series: KB  
T-1 Bi-pin

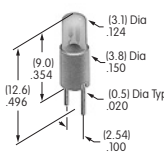

**AT617**  
Single Element LED  
Colors: C E F  
Used for AT212 Bezel

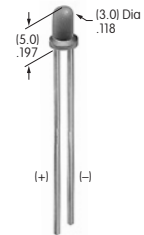

**AT618**  
Single Element LED  
Colors: C E F  
Used for AT213 Bezel

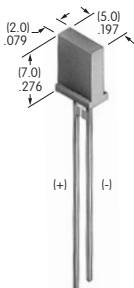

**AT621**  
6-element Bicolor LED  
Without Resistor; Volts: 2  
With Resistor; Volts: 5 12 24  
Colors: CF  
Series: YB  
T-1 1/2 Bi-pin

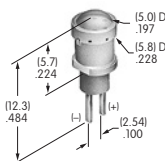

**AT622**  
Single Element LED  
Colors: C E F  
Series: MLW  
T-1 3/4 Pilot Slide Base

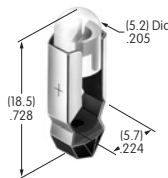

**AT624**  
Single Element LED  
Color: G  
Series: HB  
T-1 Bi-pin

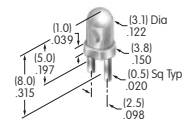

Color Codes: A Black B White C Red D Amber E Yellow F Green G Blue H Gray J Clear



# Accessories & Hardware

Toggle

Rockers

Pushbuttons

Illuminated PB

Programmable

Keylocks

Rotaries

Slides

Tactiles

Tilt

Touch

Indicators

Accessories

Supplement

## AT625

**Super Bright  
Single Element LED**  
Color: G  
Series: KB LB YB YB2  
T-1 Bi-pin

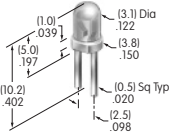

## AT627

**Bright  
4-Element LED**  
With Resistor; Volts: 5 12 24  
Colors: C D F  
Series: LB  
T-1 Bi-pin

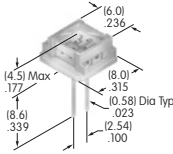

## AT628

**Bright  
Double Element LED**  
Colors: C D F  
Series: YB YB2  
T-1 Bi-pin

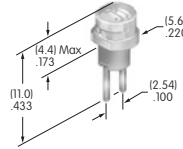

## AT629

**Single Element LED**  
Color: B  
Series: HB  
T-1 Bi-pin

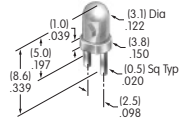

## AT630

**Single Element LED**  
Color: F  
Series: HB  
T-1 Bi-pin

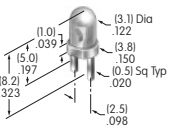

## AT631

**Super Bright  
Single Element LED**  
Color: B  
Series: KB LB YB YB2  
T-1 Bi-pin

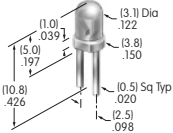

## AT632

**Super Bright  
Single Element LED**  
Color: F  
Series: KB LB YB YB2  
T-1 Bi-pin

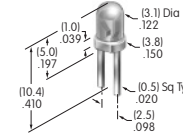

## AT633

**Single Element LED**  
Colors: C D F  
Series: HB  
T-1 Bi-pin

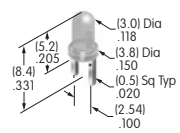

## AT634

**Bright  
2- or 4-Element LED**  
With Resistor; Volts: 5 12 24  
Colors: C D F  
Series: KB YB YB2  
T-1 1/4 Bi-pin

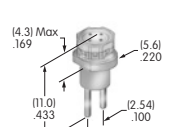

## AT635

**Bright  
Single Element LED**  
Colors: C D F  
Series: KB LB  
T-1 1/2 Bi-pin

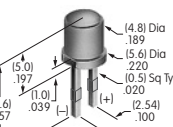

## AT636 ← NEW

**Bright  
Single Element LED**  
With Resistor; Volts: 5 12 24  
Color: F  
Series: YB2  
T-1 1/4 Bi-pin

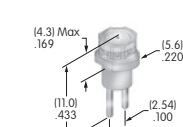

**Color Codes:** A Black B White C Red D Amber E Yellow F Green G Blue H Gray J Clear

# Accessories & Hardware

## AT700s

**AT701**  
**Single Pole**  
**Straight PC Adaptor**  
 Glass fiber  
 reinforced polyamide  
 Series: KB

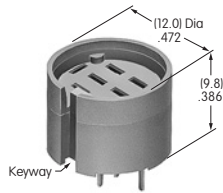

**AT702**  
**Double Pole**  
**Straight PC Adaptor**  
 Glass fiber  
 reinforced polyamide  
 Series: KB

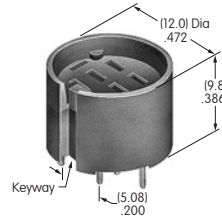

**AT711**  
**Single Pole**  
**Straight PC Adaptor**  
 Glass fiber  
 reinforced polyamide  
 Series: LB

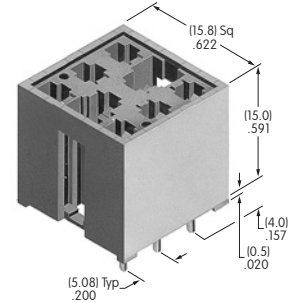

**AT712**  
**Double Pole**  
**Straight PC Adaptor**  
 Glass fiber reinforced polyamide  
 Series: LB

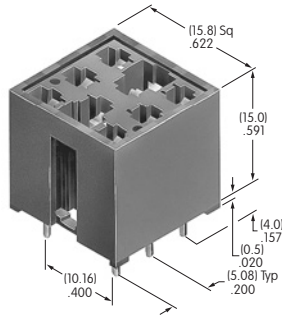

**AT713** ← **NEW**  
**Receptacle Connector**  
 Connects to RS232C  
 Compatible with  
 FTCS04B & FTCS05B (5-wire) or  
 FTCS04A & FTCS04A2 (4 wire)  
 Length: 19.7" (500.0mm)  
 Series: FT

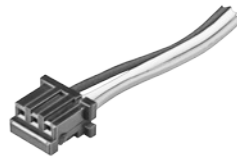

**AT714** ← **NEW**  
**Receptacle Connector**  
 Connects to Power Source  
 of Control Boards  
 FTCS04B & FTCS05B (5-wire)  
 Length: 19.7" (500.0mm)  
 Series: FT



**AT715** ← **NEW**  
**Connector Cable**  
 Cable for OLED Rocker  
 Length: 19.7" (500.0mm)  
 Series: SmartSwitch



## AT2100s

**AT2107**  
**Bezel**  
 Polyamide  
 Colors: A B E F G H  
 Series: M M2100

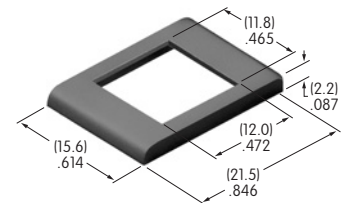

Color Codes: A Black B White C Red D Amber E Yellow F Green G Blue H Gray J Clear

# Accessories & Hardware

Toggles

Rockers

Pushbuttons

Illuminated PB

Programmable

Keylocks

Rotaries

Slides

Tactiles

Tilt

Touch

Indicators

Accessories

Supplement

## AT3000s

**AT3001**  
**Square Solid Cap**  
 Polycarbonate  
 Colors: BB CB EB FB GB  
 Series: YB

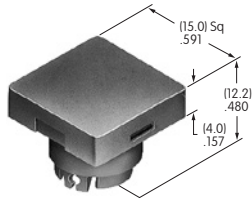

**AT3002**  
**Round Solid Cap**  
 Polycarbonate  
 Colors: BB CB EB FB GB  
 Series: YB

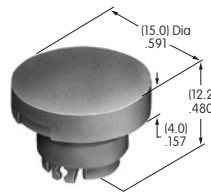

**AT3003**  
**Rectangular Solid Cap**  
 Polycarbonate  
 Colors: BB CB EB FB GB  
 Series: YB

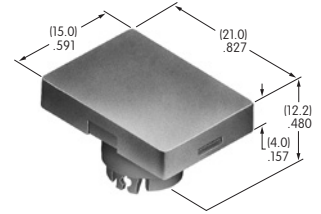

**AT3004**  
**Square Cap for Bright LED & Bicolor**  
 Polycarbonate  
 Colors: JB JC JD JF  
 Series: YB

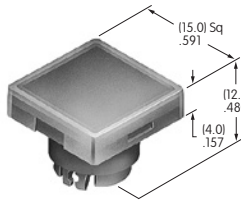

**AT3005**  
**Round Cap for Bright LED & Bicolor**  
 Polycarbonate  
 Colors: JB JC JD JF  
 Series: YB

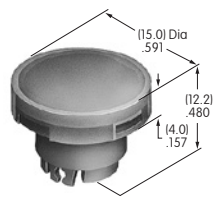

**AT3006**  
**Rectangular Cap for Bright LED & Bicolor**  
 Polycarbonate  
 Colors: JB JC JD JF  
 Series: YB

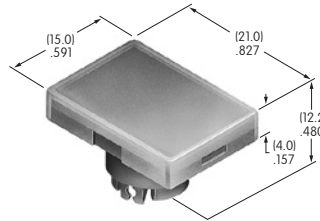

**AT3010**  
**Square Spot Illuminated Cap with Built-in LED**  
 Without Resistor; Volts: 2  
 With Resistor; Volts: 5 12 24  
 Polycarbonate  
 Cap Colors: JA JB JC JE JF  
 LED Colors: C D F CF  
 Series: YB

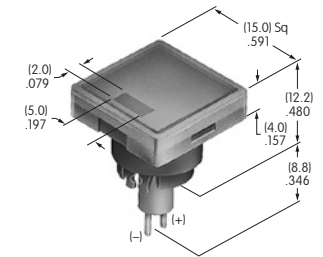

**AT3011**  
**Round Spot Illuminated Cap with Built-in LED**  
 Without Resistor; Volts: 2  
 With Resistor; Volts: 5 12 24  
 Polycarbonate  
 Cap Colors: JA JB JC JE JF  
 LED Colors: C D F CF  
 Series: YB

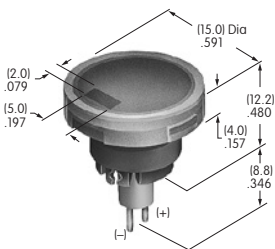

**AT3012**  
**Rectangular Spot Illuminated Cap with Built-in LED**  
 Without Resistor; Volts: 2  
 With Resistor; Volts: 5 12 24  
 Polycarbonate  
 Cap Colors: JA JB JC JE JF  
 LED Colors: C D F CF  
 Series: YB

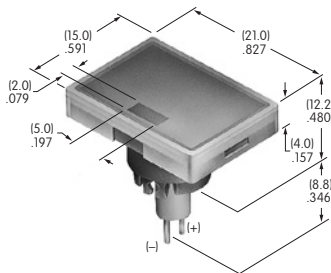

**AT3014**  
**Square Cap for Super Bright LED**  
 Polycarbonate  
 Colors: JB  
 Series: YB

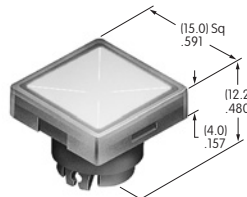

**AT3015**  
**Round Cap for Super Bright LED**  
 Polycarbonate  
 Colors: JB  
 Series: YB

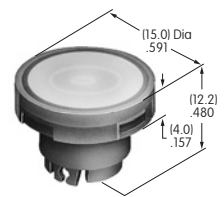

**Color Codes:** A Black B White C Red D Amber E Yellow F Green G Blue H Gray J Clear

# Accessories & Hardware

**AT3016**  
**Rectangular Cap for Super Bright LED**  
 Polycarbonate  
 Color: JB  
 Series: YB

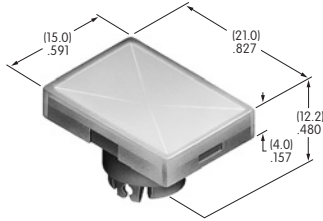

**AT3017** ← **NEW**  
**Round Cap for Bright LED**  
 Polycarbonate  
 Colors: JB CB EB FB  
 Series: YB2

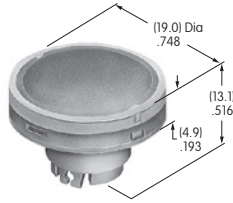

**AT3018** ← **NEW**  
**Round Cap for Super Bright LED**  
 Polycarbonate  
 Color: JB  
 Series: YB2

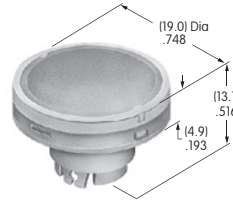

**AT3019** ← **NEW**  
**Round Solid Cap**  
 Polycarbonate  
 Color: S (Metallic Silver)  
 Series: YB2

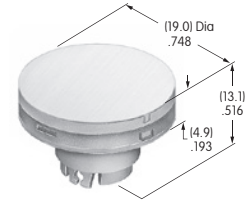

**AT3020** ← **NEW**  
**Round Cap for Bright or Super Bright LED with Clear Illumination Ring**  
 Lens: Polycarbonate  
 Insert: Polyester  
 Color: JS (Metallic Silver with Clear Ring)  
 Series: YB2

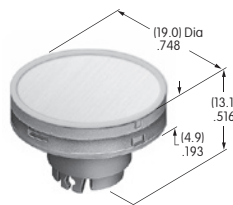

**AT3021**  
**Flat Cap for Barrier Flange**  
 Polyphenylene oxide  
 Colors: A B C H  
 Series: JP

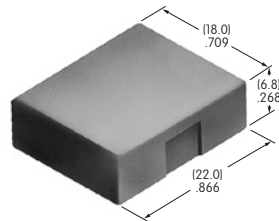

**AT3022** ← **NEW**  
**Square Cap for Single or Bicolor LED**  
 Polycarbonate Resin  
 Colors: JB JC JD JF  
 Series: NP01

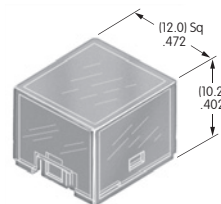

**AT3023** ← **NEW**  
**Square Cap for Bicolor LED with Alternating Legends**  
 Polycarbonate Resin  
 Color: J  
 Series: NP01

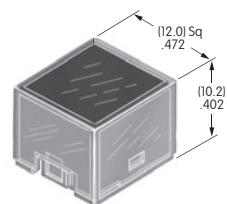

**AT3024** ← **NEW**  
**Square Solid Cap**  
 Polycarbonate Resin  
 Colors: A B C H  
 Series: NP01

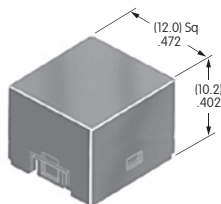

**AT3069**  
**Sculptured Cap with Alternating Legend for Illuminated**  
 Polycarbonate  
 Color: J  
 Series: UB2

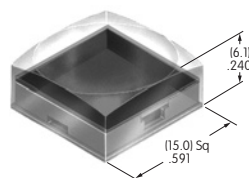

**AT3070**  
**Flat Cap with Alternating Legend for Illuminated**  
 Polycarbonate  
 Color: J  
 Series: UB2

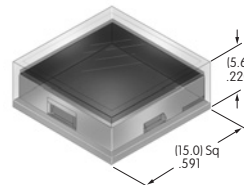

**AT3073**  
**Sculptured Cap for Nonilluminated**  
 Polycarbonate  
 Colors: JA JB JC JD JF  
 Series: UB2

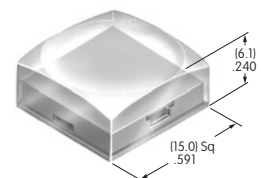

**Color Codes:** A Black B White C Red D Amber E Yellow F Green G Blue H Gray J Clear

# Accessories & Hardware

Toggle

Rockers

Pushbuttons

Illuminated PB

Programmable

Keylocks

Rotaries

Slides

Tactiles

Tilt

Touch

Indicators

Accessories

Supplement

**AT3074**  
**Sculptured Cap for Illuminated**  
 Polycarbonate  
 Colors: JB JC JD JF  
 Series: UB2

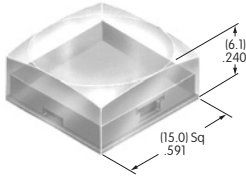

**AT3075**  
**Beveled Cap for Illuminated**  
 Polycarbonate  
 Colors: B C D F  
 Series: UB2

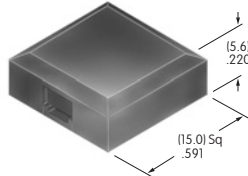

**AT3076**  
**Flat Cap for Illuminated with Lens/Diffuser**  
 Polycarbonate  
 Colors: JB JC JD JF  
 Series: UB2

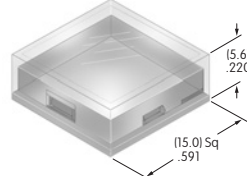

**AT3077**  
**Beveled Cap for Nonilluminated**  
 Polycarbonate  
 Colors: A B C D F  
 Series: UB2

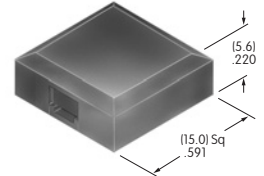

**AT3078**  
**12mm Sculptured Cap with Lens/Diffuser**  
 Polycarbonate  
 Colors: JB  
 Series: KP

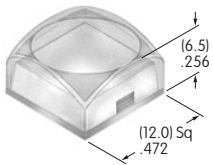

**AT3079**  
**15mm Sculptured Cap with Lens/Diffuser**  
 Polycarbonate  
 Colors: JB  
 Series: KP

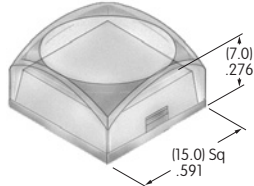

**AT3080**  
**17.4mm Sculptured Cap with Lens/Diffuser**  
 Polycarbonate  
 Colors: JB  
 Series: KP

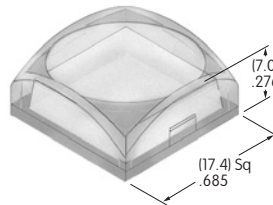

**AT3081**  
**Transparent Lens**  
 Polycarbonate  
 Color: J  
 Series: HB2

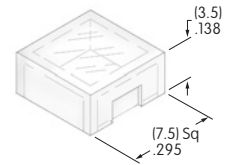

**AT3082**  
**Translucent Diffuser**  
 Polycarbonate  
 Color: B  
 Series: HB2

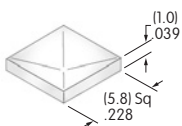

**AT3083**  
**12mm Flat Cap with Lens/Diffuser**  
 Polycarbonate  
 Colors: JB  
 Series: KP

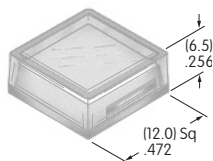

**AT3084**  
**15mm Flat Cap with Lens/Diffuser**  
 Polycarbonate  
 Colors: JB  
 Series: KP

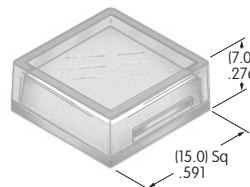

**AT3085**  
**17.4mm Flat Cap with Lens/Diffuser**  
 Polycarbonate  
 Colors: JB  
 Series: KP

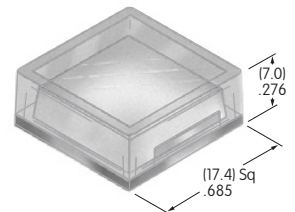

**Color Codes:** A Black B White C Red D Amber E Yellow F Green G Blue H Gray J Clear

# Accessories & Hardware

## AT3086

### 12mm Home Key Cap with Lens/Diffuser

Polycarbonate  
Colors: JB  
Series: KP

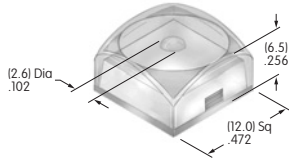

## AT3087

### 15mm Home Key Cap with Lens/Diffuser

Polycarbonate  
Colors: JB  
Series: KP

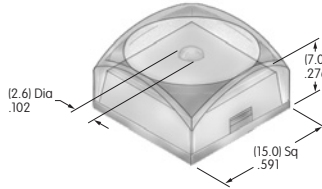

## AT3088

### 17.4mm Home Key Cap with Lens/Diffuser

Polycarbonate  
Colors: JB  
Series: KP

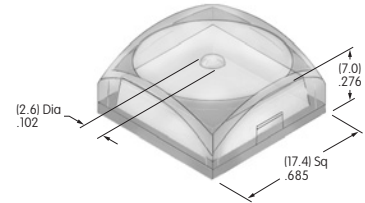

## AT4000s

### AT4001

#### Square Dust Cover

Lid: Polyvinyl chloride  
Gasket: Polyethylene  
Series: LB UB

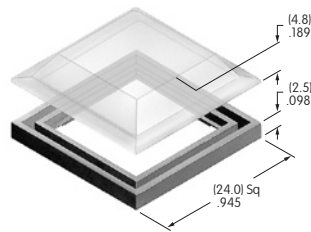

### AT4002

#### Round Dust Cover

Lid: Polyvinyl chloride  
Gasket: Polyethylene  
Series: LB

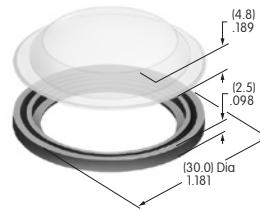

### AT4003

#### .394" Bat Lever Cap

Polyvinyl chloride  
Colors: A B C  
Series: A B

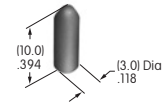

## AT4011

### Rectangular Dust Cover

Lid: Polyvinyl chloride  
Gasket: Polyethylene  
Series: LB UB

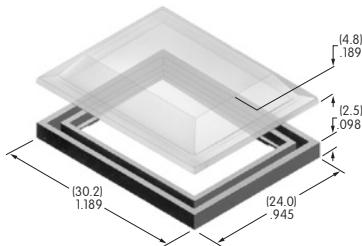

## AT4012

### Round Solid Colored Cap

Polycarbonate  
Colors: BJ CJ EJ FJ GJ  
Series: LB

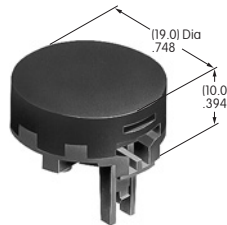

## AT4013

### Round Colored Insert Cap

Polycarbonate  
Colors: JB JC JE JF JG  
Series: LB

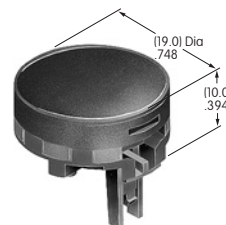

## AT4016

### Round Spot Illuminated Cap

Polycarbonate  
Cap Colors: A B C F  
LED Colors: C D F CF  
Series: LB

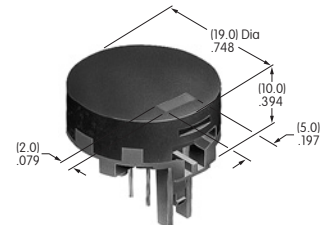

Color Codes: A Black B White C Red D Amber E Yellow F Green G Blue H Gray J Clear

# Accessories & Hardware

Toggle

Rockers

Pushbuttons

Illuminated PB

Programmable

Keylocks

Rotaries

Slides

Tactiles

Tilt

Touch

Indicators

Accessories

Supplement

**AT4017**  
**Round Nonilluminated Cap**  
 Polycarbonate  
 Colors: A B C E F G H  
 Series: LB

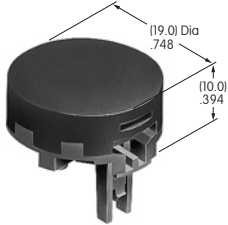

**AT4021**  
**Rectangular Solid Colored Cap**  
 Polycarbonate  
 Colors: A BB CB CC EB  
 FB FF GB GG  
 Series: KB

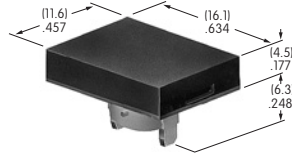

**AT4022**  
**Rectangular Colored Insert Cap**  
 Polycarbonate  
 Cap Colors: JB JC JE JF JG  
 Series: KB

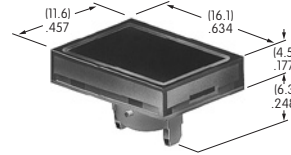

**AT4024**  
**Protective Guard**  
 Cover: Polycarbonate  
 Base: Polyamide  
 Series: KB

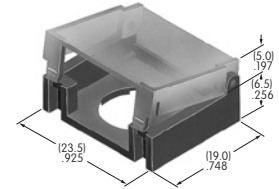

**AT4025**  
**Rectangular Dust Cover**  
 Lid: Polyvinyl chloride  
 Base: Polyamide  
 Series: KB

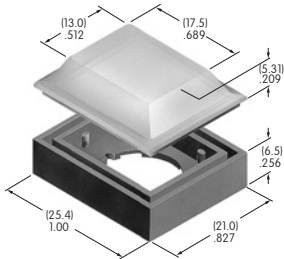

**AT4026**  
**Rectangular Solid Colored Cap**  
 Polycarbonate  
 Colors: BJ CJ EJ FJ GJ  
 Series: LB

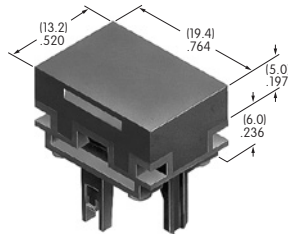

**AT4027**  
**Rectangular Colored Insert Cap**  
 Polycarbonate  
 Colors: JB JC JE JF JG  
 Series: LB

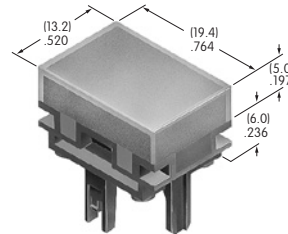

**AT4030**  
**Rectangular Nonilluminated Cap**  
 Polycarbonate  
 Colors: A B C E F G H  
 Series: LB

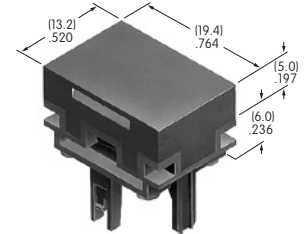

**AT4031**  
**Square Cap for Bright & Super Bright LED**  
 Polycarbonate  
 Colors: JB  
 Series: HB

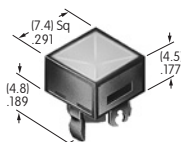

**AT4032**  
**Round Cap for Bright & Super Bright LED**  
 Polycarbonate  
 Colors: JB  
 Series: HB

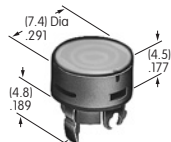

**AT4033**  
**Square Indicator Cap**  
 Polycarbonate  
 Colors: JB  
 Series: HB

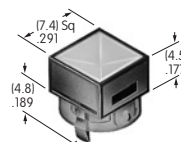

**AT4034**  
**Round Indicator Cap**  
 Polycarbonate  
 Colors: JB  
 Series: HB

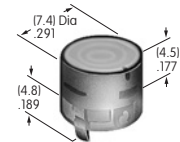

**Color Codes:** A Black B White C Red D Amber E Yellow F Green G Blue H Gray J Clear

# Accessories & Hardware

**AT4035**  
**Square Nonilluminated Cap**  
 Polycarbonate  
 Colors: A B C E F G  
 Series: HB

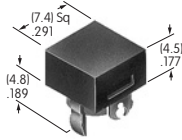

**AT4036**  
**Round Nonilluminated Cap**  
 Polycarbonate  
 Colors: B C E F G  
 Series: HB

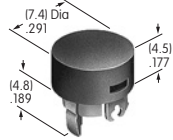

**AT4041 (M-metric H-inch)**  
**Splashproof Boot for Momentary**  
 Black silicone rubber  
 Series: MB

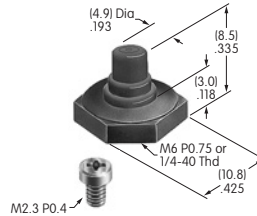

**AT4042 (M-metric H-inch)**  
**Splashproof Boot for Alternate**  
 Black silicone rubber  
 Series: MB

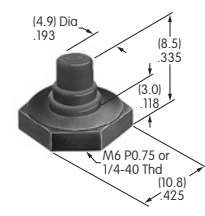

**AT4043**  
**Splashproof Boot**  
 Black silicone rubber  
 Series: MB SB WB

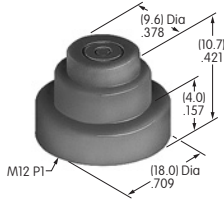

**AT4051**  
**Spot Illuminated Cap**  
 Polycarbonate  
 Colors: AB  
 Series: KB

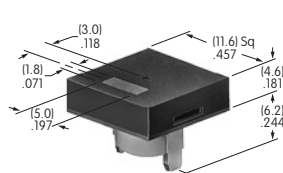

**AT4052**  
**Spot Illuminated Cap**  
 Polycarbonate  
 Colors: AB  
 Series: HB

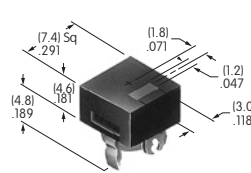

**AT4054**  
**Round Solid Colored Cap**  
 Polycarbonate  
 Colors: BJ CJ EJ FJ GJ  
 Series: LB Panel Seal

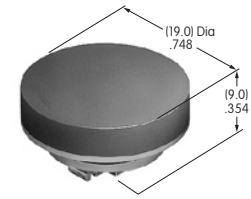

**AT4055**  
**Round Colored Insert Cap**  
 Polycarbonate  
 Colors: JB JC JE JF JG  
 Series: LB Panel Seal

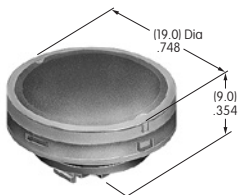

**AT4057**  
**Protective Guard**  
 Polycarbonate  
 Series: LB

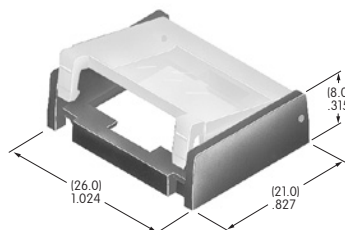

**AT4058**  
**Sculptured Cap**  
 Polyamide  
 Colors: A B C E F G H  
 Series: JB

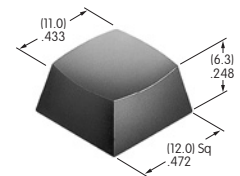

**Color Codes:** A Black B White C Red D Amber E Yellow F Green G Blue H Gray J Clear



# Accessories & Hardware

Toggles

Rockers

Pushbuttons

Illuminated PB

Programmable

Keylocks

Rotaries

Slides

Tactiles

Tilt

Touch

Indicators

Accessories

Supplement

**AT4059**  
**Flat Cap**  
 Polycarbonate  
 Colors: A B C E F G H  
 Series: JB

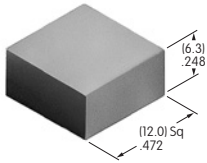

**AT4060**  
**Clear Cap with Colored Diffuser**  
 Polycarbonate  
 Colors: JB JC JE JF  
 Series: JB

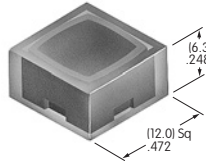

**AT4062**  
**Rocker**  
 Polyamide  
 Colors: A B C  
 Series: G

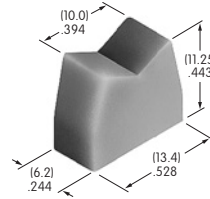

**AT4063**  
**.157" Diameter Slip-on Cap**  
 Polyamide  
 Colors: A B C  
 Series: GB G3B

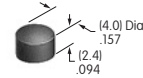

**AT4064**  
**.248" Bat Lever Cap**  
 Polyvinyl chloride  
 Colors: A B C  
 Series: A B

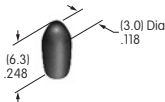

**AT4065**  
**Slide Cap**  
 Polycarbonate  
 Cap Color: A  
 Window: C E F  
 Series: SS

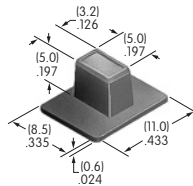

**AT4072**  
**Protective Guard**  
 Lid: Polycarbonate  
 Base: Glass fiber reinforced polycarbonate  
 Series: YB

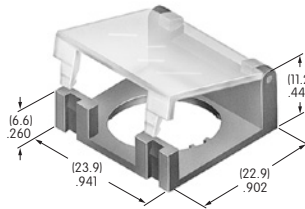

**AT4073**  
**Square Opaque Cap for Nonilluminated**  
 Polycarbonate  
 Colors: A B C E F G  
 Series: UB

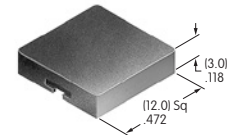

**AT4074**  
**Square Transparent Cap for Illuminated**  
 Polycarbonate  
 Colors: C D F J  
 Series: UB

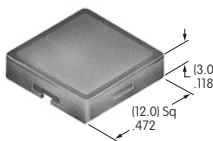

**AT4075**  
**Diffuser for AT4074 Square Cap**  
 Polycarbonate  
 Colors: B C D F  
 Series: UB

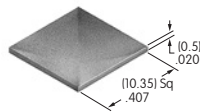

**AT4076**  
**Button with Frame for Illuminated**  
 Polycarbonate  
 Colors: BB BC BE BF BH  
 Series: JB

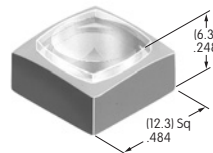

**AT4077**  
**Button for Nonilluminated**  
 Polycarbonate  
 Colors: B C E F G H  
 Series: JB

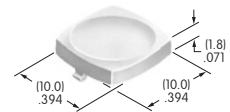

**Color Codes:** A Black B White C Red D Amber E Yellow F Green G Blue H Gray J Clear

# Accessories & Hardware

## AT4078

**Frame for AT4077**  
Polycarbonate  
Colors: B C E F G H  
Series: JB

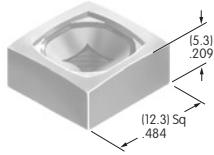

## AT4079

**Actuator Key**  
Brass alloy with  
bright nickel plating  
Series: SK

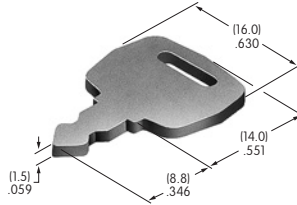

## AT4080

**Actuator Key**  
Brass alloy with  
bright nickel plating  
Antistatic ABS resin handle  
Color: A  
Series: SK

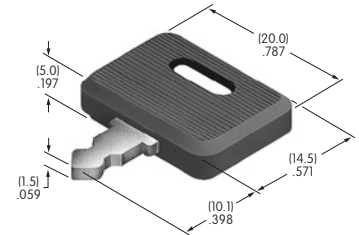

## AT4081

**Actuator Key**  
Zinc alloy with chrome plating  
Series: SK

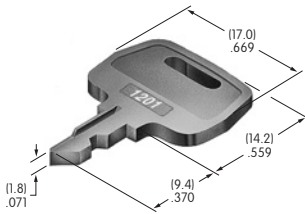

## AT4082

**Actuator Key**  
Zinc alloy with chrome plating  
Series: SK

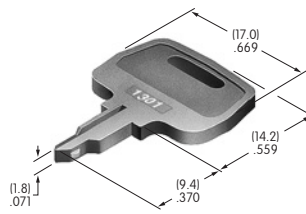

## AT4094

**Actuator Key**  
Polyacetal  
Color: A  
Series: SK

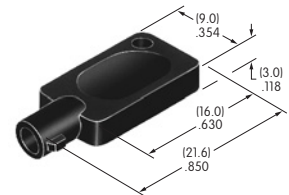

# AT4100s

## AT4103

**Small Color Tipped Knob**  
Polyester with polyamide tip  
Base Color: A  
Tip Colors: A B C E F G H  
Series: FR01 MR

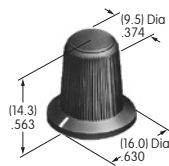

## AT4104

**Large Color Tipped Knob**  
Polyester with polyamide tip  
Base Color: A  
Tip Colors: A B C E F G H  
Series: FR01 MR

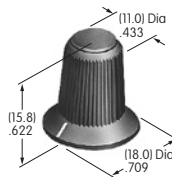

## AT4115

**Dust Cover**  
Lid: Polyvinyl chloride  
Base: Polyamide  
Series: YB

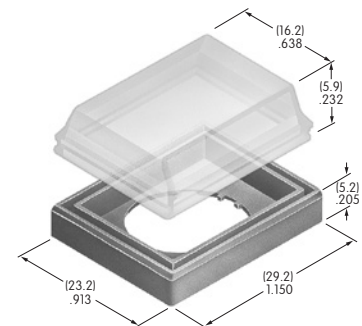

Color Codes: A Black B White C Red D Amber E Yellow F Green G Blue H Gray J Clear

# Accessories & Hardware

Toggle

Rockers

Pushbuttons

Illuminated PB

Programmable

Keylocks

Rotaries

Slides

Tactiles

Tilt

Touch

Indicators

Accessories

Supplement

**AT4116**  
**Rectangular Opaque Cap for Nonilluminated**  
 Polycarbonate  
 Colors: A B C E F G  
 Series: UB

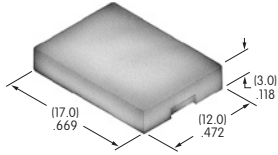

**AT4117**  
**Rectangular Transparent Cap for Illuminated**  
 Polycarbonate  
 Colors: C D F J  
 Series: UB

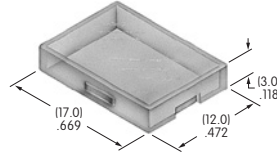

**AT4118**  
**Diffuser for AT4117 Rectangular Transparent Cap**  
 Polycarbonate  
 Colors: B C D F  
 Series: UB

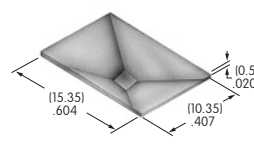

**AT4119**  
**Square Spot Illuminated Cap**  
 Polycarbonate  
 Colors: AB  
 Series: UB

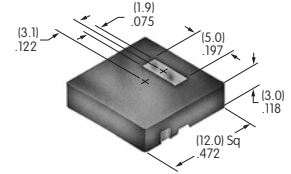

**AT4120**  
**Rectangular Spot Illuminated Cap**  
 Polycarbonate  
 Colors: AB  
 Series: UB

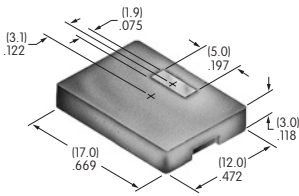

**AT4124**  
**Actuator Key**  
 Brass with nickel plating  
 Series: SK

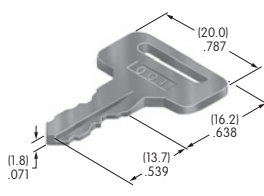

**AT4125**  
**LED Rocker**  
 Polycarbonate  
 Colors: B C E F  
 Series: MLW

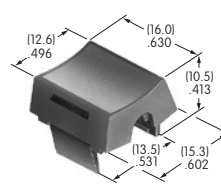

**AT4126**  
**Dust Cover**  
 Polyvinyl chloride & polyamide  
 Color: A  
 Series: JWJ

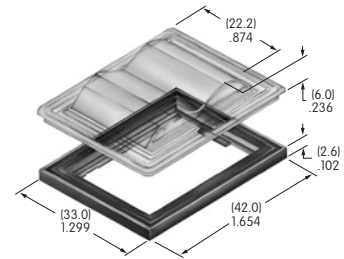

**AT4127**  
**Sculptured Rocker**  
 Polycarbonate  
 Colors: B C E F  
 Series: MLW

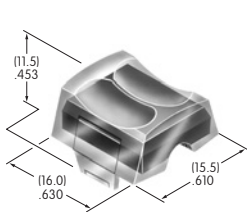

**AT4128**  
**Round Cap for Super Bright LED**  
 Polycarbonate  
 Colors: JB  
 Series: LB

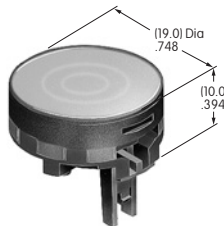

**AT4129**  
**Square Cap for Super Bright LED**  
 Polycarbonate  
 Colors: JB  
 Series: LB

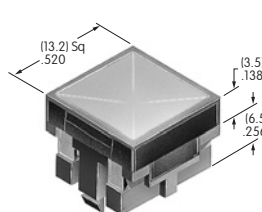

**AT4130**  
**Rectangular Cap for Super Bright LED**  
 Polycarbonate  
 Colors: JB  
 Series: LB

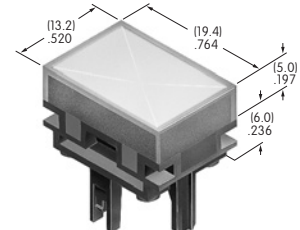

**Color Codes:** A Black B White C Red D Amber E Yellow F Green G Blue H Gray J Clear

# Accessories & Hardware

**AT4131**  
**Round Cap for Super Bright LED**  
 Polycarbonate  
 Colors: JB  
 Series: LB Panel Seal



**AT4132**  
**Round Cap for Bright & Super Bright LED**  
 Polycarbonate  
 Colors: JB  
 Series: KB



**AT4133**  
**Square Cap for Bright & Super Bright LED**  
 Polycarbonate  
 Colors: JB  
 Series: KB



**AT4134**  
**Rectangular Cap for Bright & Super Bright LED**  
 Polycarbonate  
 Colors: JB  
 Series: KB

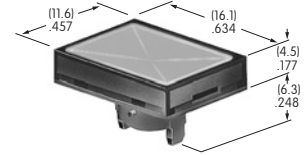

**AT4135**  
**Frosted Cap with White Base**  
 Polycarbonate  
 Colors: B C E F  
 Series: JB

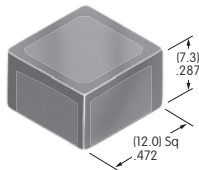

**AT4137**  
**Rectangular Cap**  
 PBT  
 Colors: A B C  
 Series: GB2

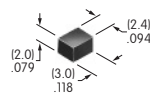

**AT4139**  
**Square Flat Cap**  
 Polycarbonate  
 Colors: A B C H  
 Series: JB

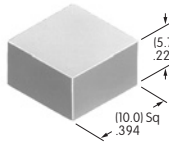

**AT4140**  
**Cap for Mounter AT547**  
 Polycarbonate  
 Colors: A B C H  
 Series: JB

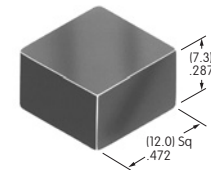

**AT4141**  
**Protective Guard**  
 Cover: Polycarbonate  
 Base: GFR polyamide  
 Series: UB2

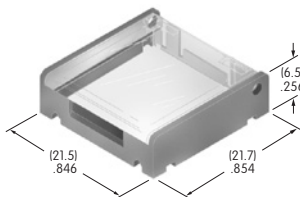

**AT4142**  
**Spring Loaded Protective Guard**  
 Cover: Polycarbonate  
 Base: GFR polyamide  
 Coil spring: Stainless steel  
 Series: UB2

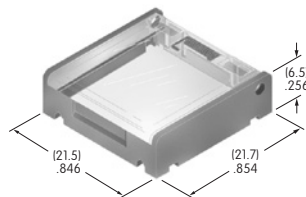

**AT4143**  
**End Barrier**  
 Polyamide  
 Color: A  
 Series: UB2

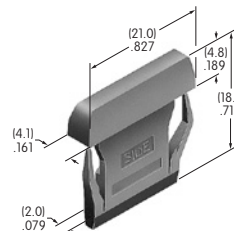

**AT4144**  
**Center Barrier**  
 Polyamide  
 Color: A  
 Series: UB2

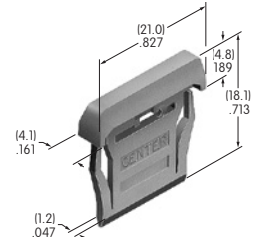

Color Codes: A Black B White C Red D Amber E Yellow F Green G Blue H Gray J Clear

# Accessories & Hardware

Toggle

Rockers

Pushbuttons

Illuminated PB

Programmable

Keylocks

Rotaries

Slides

Tactiles

Tilt

Touch

Indicators

Accessories

Supplement

**AT4145**  
**Square Dust Cover**  
 Lid: PVC  
 Gasket: Polyethylene  
 Series: UB2

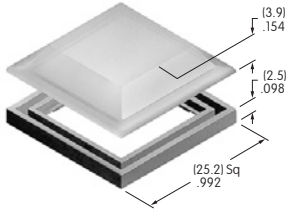

**AT4146**  
**Tubular Key**  
 Brass with nickel plating  
 ABS handle  
 Color: A  
 Series: CKM

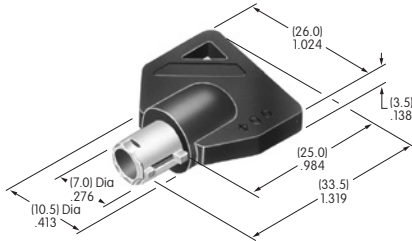

**AT4147**  
**Flat Key**  
 Brass with nickel plating  
 ABS handle  
 Color: A  
 Series: CKM

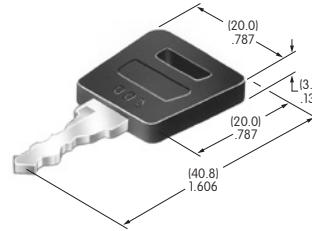

**AT4148**  
**.365" Wide Rocker**  
 Polyamide  
 Colors: A B C E F G H  
 Series: M M2T P

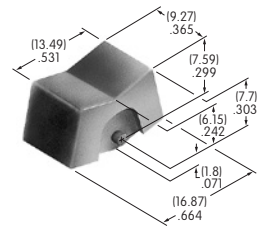

**AT4149**  
**.365" Wide Paddle**  
 Polyamide  
 Colors: A B C E F G H  
 Series: M M2T P

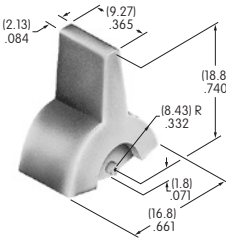

**AT4150**  
**.450" Wide Rocker**  
 Polyamide  
 Colors: A B C E F G H  
 Series: M M2T

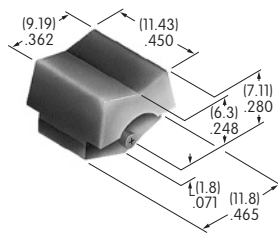

**AT4151**  
**.450" Wide Paddle**  
 Polyamide  
 Colors: A B C E F G H  
 Series: M M2T

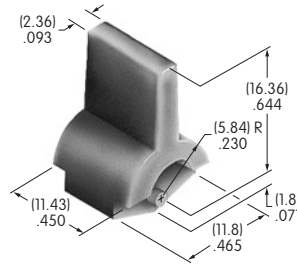

**AT4152**  
**Tubular Key**  
 Brass with nickel plating  
 Series: CKL

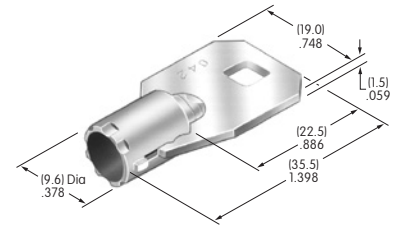

**AT4153**  
**Flat Key**  
 Brass with chrome plating  
 Series: CKL

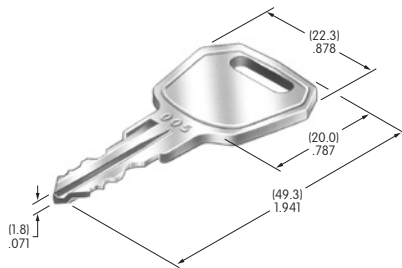

**AT4156**  
**.595" Wide Rocker**  
 Polyamide  
 Colors: A B C E F G H  
 Series: M P

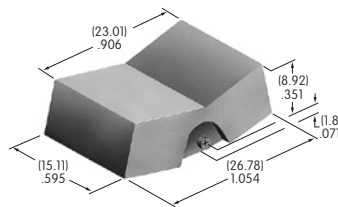

**AT4157**  
**.595" Wide Paddle**  
 Polyamide  
 Colors: A B C E F G H  
 Series: M P

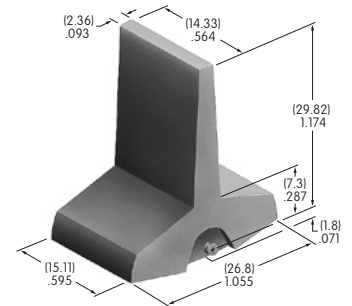

**Color Codes:** A Black B White C Red D Amber E Yellow F Green G Blue H Gray J Clear

# Accessories & Hardware

## AT4158

**Square Cap for Bright LED**  
Polycarbonate  
Colors: JC JD JF  
Series: KB

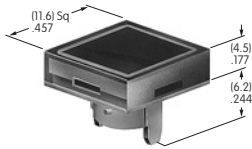

## AT4159

**Rectangular Cap for Bright LED**  
Polycarbonate  
Colors: JC JD JF  
Series: KB

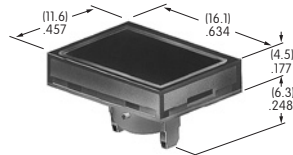

## AT4160

**Round Cap for Bright LED**  
Polycarbonate  
Colors: JC JD JF  
Series: KB



## AT4162

**Square Cap for Bright LED**  
Polycarbonate  
Colors: JB JC JD JF  
Series: LB

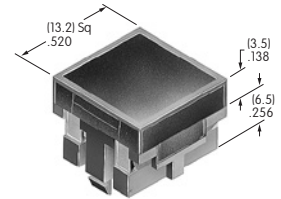

## AT4163

**Rectangular Cap for Bright LED**  
Polycarbonate  
Colors: JB JC JD JF  
Series: LB

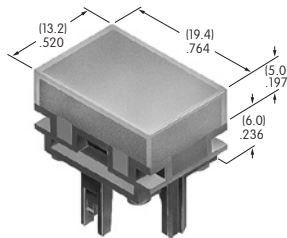

## AT4164

**Round Cap for Bright LED**  
Polycarbonate  
Colors: JB JC JD JF  
Series: LB



## AT4165

**Round Cap for Bright LED**  
Polycarbonate  
Colors: JB JC JD JF  
Series: LB Panel Seal

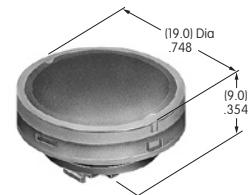

## AT4166

**Square Cap for Bright LED**  
Polycarbonate  
Colors: CB DB FB  
Series: HB

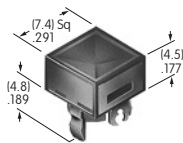

## AT4167

**Round Cap for Bright LED**  
Polycarbonate  
Colors: CB DB FB  
Series: HB

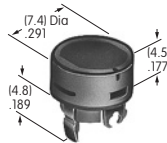

## AT4168

**Square Indicator Cap for Bright LED**  
Polycarbonate  
Colors: CB DB FB  
Series: HB

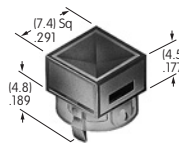

## AT4169

**Round Indicator Cap for Bright LED**  
Polycarbonate  
Colors: CB DB FB  
Series: HB

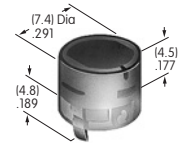

Color Codes: A Black B White C Red D Amber E Yellow F Green G Blue H Gray J Clear

# Accessories & Hardware

Toggles

Rockers

Pushbuttons

Illuminated PB

Programmable

Keylocks

Rotaries

Slides

Tactiles

Tilt

Touch

Indicators

Accessories

Supplement

**AT4170**  
**Spring Loaded Protective Guard**  
 Cover: Polycarbonate  
 Base: Polyamide  
 Coil spring: Stainless steel  
 Series: UB2

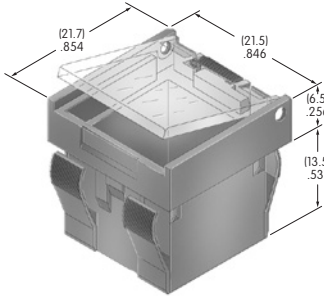

**AT4171**  
**Spring Loaded Protective Guard**  
 Cover: Polycarbonate  
 Base: Polyamide  
 Coil spring: Stainless steel  
 Series: LB UB

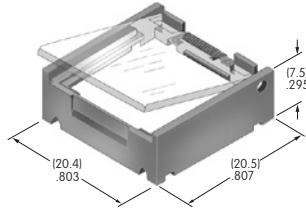

**AT4172**  
**Spring Loaded Protective Guard**  
 Cover: Polycarbonate  
 Base: Polyamide  
 Coil spring: Stainless steel  
 Series: LB UB

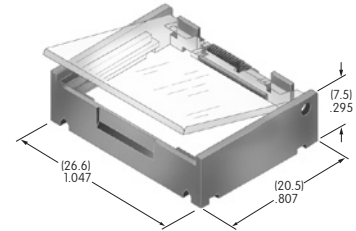

**AT4173**  
**Spring Loaded Protective Guard**  
 Cover: Polycarbonate  
 Base: Polyamide  
 Coil spring: Stainless steel  
 Series: UB

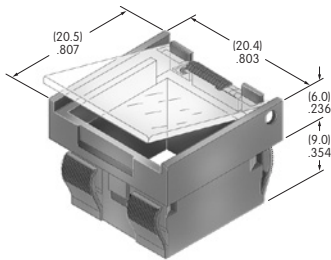

**AT4174**  
**Spring Loaded Protective Guard**  
 Cover: Polycarbonate  
 Base: Polyamide  
 Coil spring: Stainless steel  
 Series: UB

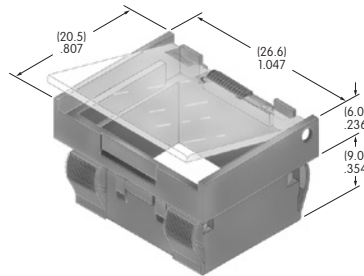

**AT4175**  
**Spring Loaded Protective Guard**  
 Cover: Polycarbonate  
 Base: Glass fiber reinforced polyamide  
 Coil spring: Stainless steel  
 Series: YB

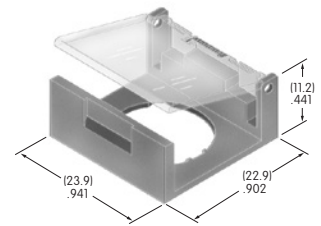

**AT4176**  
**Square Cap for Bright LED**  
 Polycarbonate  
 Colors: JB JC JD JF  
 Series: LB

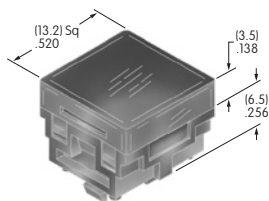

**AT4177**  
**Rectangular Cap for Bright LED**  
 Polycarbonate  
 Colors: JB JC JD JF  
 Series: LB

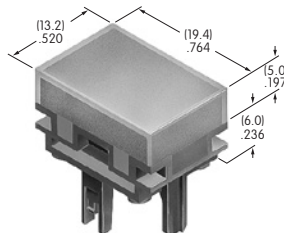

**AT4178**  
**Round Cap for Bright LED**  
 Polycarbonate  
 Colors: JB JC JD JF  
 Series: LB

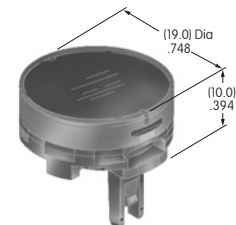

**Color Codes:** A Black B White C Red D Amber E Yellow F Green G Blue H Gray J Clear

## AT4179

### Round Cap for Bright LED

Polycarbonate  
Colors: JB JC JD JF  
Series: LB Panel Seal

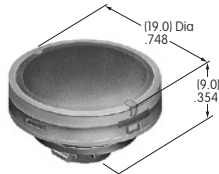

## AT4180

### Snap-on Knob

Polyamide  
Knob: Black  
Flange: Transparent brown  
Series: FRO1

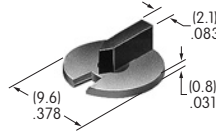

## AT4181 ← NEW

### Splashproof Boot Assembly

Boot Material: Black silicon rubber  
Hex Nut Material & Finish:  
Nickel plated brass  
O-ring Material:  
Nitrile butadiene rubber  
Series: M P S WT

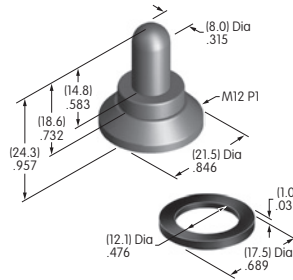

#### Switch Installation Instructions

1. Install switch bushing into mounting hole of panel from the back and adjust bushing to protrude 3.5 ~ 5.5mm (.138 ~ .217").
2. Install o-ring on bushing and tighten nut from above.
3. Insert boot onto nut. Be sure the boot and nut are a firm, secure fit.

#### Non-Splashproof Switches

##### M, P or S Toggles with 12mm Bushings

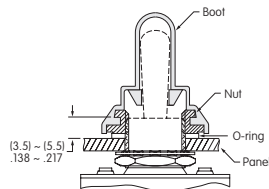

Use boot, nut and o-ring as shown. Use lockwasher and hexagon nut (from standard switch hardware) behind panel.

#### For 12mm Bushings in M, P, S & WT Toggles

##### Boot & Nut Assembly Instructions

1. Stretch base of the boot to fit around outer edges of the nut.
2. The ridge inside of boot must be firmly seated in groove of the nut.
3. Moving all around perimeter, push (with about 10N of force) toward center to assure boot seals tightly into groove (with no air pockets).

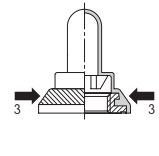
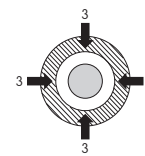
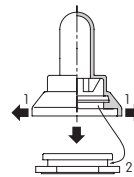

#### Splashproof Switches

##### S1AW ~ S29AW S Toggles

##### WT Toggles or M Toggle with B3 Bushing

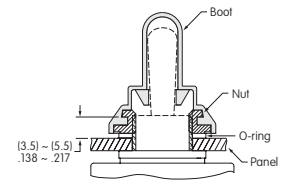
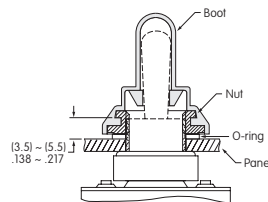

Use boot, nut and o-ring as shown. Use o-ring only (from standard switch hardware) behind panel.

Series or Part Numbers	Panel Thickness (Maximum)
<ul style="list-style-type: none"> <li>• M Series B2 Toggles with 12mm B1 &amp; B3 Bushings</li> <li>• P Series B Toggles with 12mm Bushing</li> <li>• S31 ~ 39, S41 ~ 49, S31F ~ 33F, S41F ~ S43F, S31T ~ 33T, S41T ~ 43T</li> <li>• S301 ~ 309, S331 ~ 339, S301F, S331F ~ 333F, S335F, S301T ~ 309T, S331T ~ 339T</li> <li>• S421 ~ 429, S421T ~ 429</li> </ul>	5.0mm (.197")
<ul style="list-style-type: none"> <li>• WT11S ~ 29S, WT11T ~ 29T, WT11L ~ 29L</li> </ul>	3.5mm (.138")
<ul style="list-style-type: none"> <li>• S1A ~ 7A, S21A, S1F ~ 7F, S21F</li> <li>• S114, S116</li> <li>• S1AW ~ 9AW, S21AW, S25AW ~ 29AW</li> </ul>	3.0mm (.118")

Color Codes: A Black B White C Red D Amber E Yellow F Green G Blue H Gray J Clear



# Accessories & Hardware

Toggle

Rockers

Pushbuttons

Illuminated PB

Programmable

Keylocks

Rotaries

Slides

Tactiles

Tilt

Touch

Indicators

Accessories

Supplement

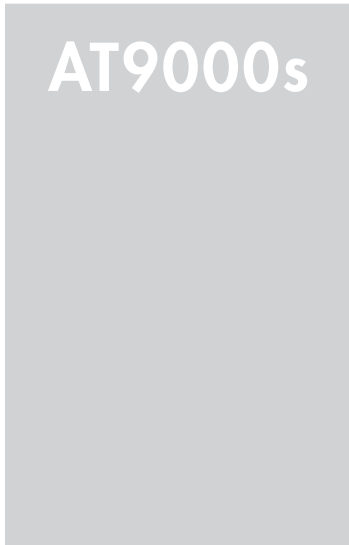

**AT9201**  
**Bezel**  
 Polycarbonate  
 Colors: A B C D E F G H  
 Series: MLW

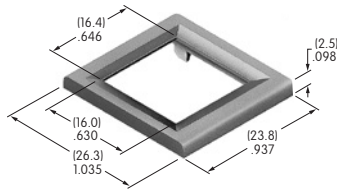

**AT9410**  
**Round Splash Cover**  
 Lid: Polyvinyl chloride  
 Base: Polyethylene  
 O-ring: Nitrile butadiene rubber  
 Series: LB Panel Seal

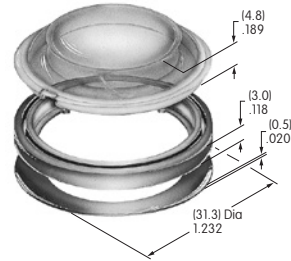

**AT9704-02YC**  
**Socket for LCD 36 x 24**  
**Single & Bicolor Pushbutton**  
 Base: Glass fiber reinforced PBT  
 Terminals: Brass/beryllium copper  
 Series: SmartSwitch

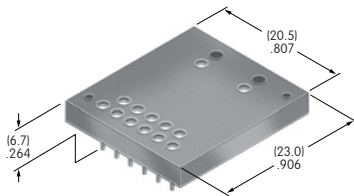

**AT9704-065E** ← **NEW**  
**Socket for LCD 36 x 24**  
**RGB Pushbutton**  
 Base: Glass fiber reinforced PBT  
 Terminals: Brass/beryllium copper  
 Series: SmartSwitch

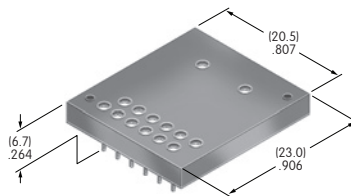

**AT9704-065F**  
**Socket for LCD 36 x 24**  
**Compact Pushbutton**  
 Base: Glass fiber reinforced PBT  
 Terminals: Brass/beryllium copper  
 Series: SmartSwitch

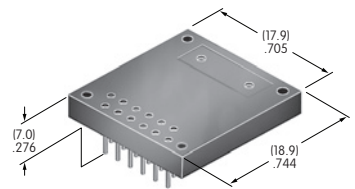

Note: By extracting some of the pins, socket may be used for the **64 x 32 Compact Pushbutton**

**AT9704-085K** ← **NEW**  
**Socket for LCD 64 x 32 Pushbutton**  
 Base: Glass fiber reinforced PBT  
 Terminals: Brass/beryllium copper  
 Series: SmartSwitch

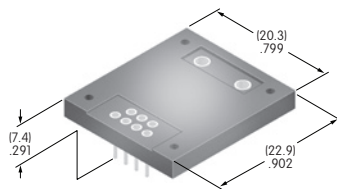

**AT9704-085L** ← **NEW**  
**Socket for OLED 64 x 48 Pushbutton**  
 Base: Glass fiber reinforced PBT  
 Terminals: Brass/beryllium copper  
 Series: SmartSwitch

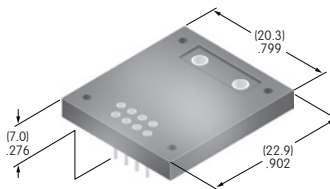

**AT9704-085M** ← **NEW**  
**Socket for OLED 52 x 36 Display**  
 Base: Glass fiber reinforced PBT  
 Terminals: Brass/beryllium copper  
 Series: SmartSwitch

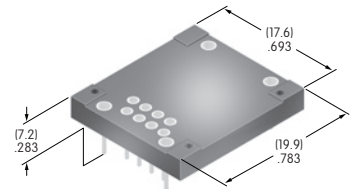

**Color Codes:** A Black B White C Red D Amber E Yellow F Green G Blue H Gray J Clear



Компания «ЭлектроПласт» предлагает заключение долгосрочных отношений при поставках импортных электронных компонентов на взаимовыгодных условиях!

Наши преимущества:

- Оперативные поставки широкого спектра электронных компонентов отечественного и импортного производства напрямую от производителей и с крупнейших мировых складов;
- Поставка более 17-ти миллионов наименований электронных компонентов;
- Поставка сложных, дефицитных, либо снятых с производства позиций;
- Оперативные сроки поставки под заказ (от 5 рабочих дней);
- Экспресс доставка в любую точку России;
- Техническая поддержка проекта, помощь в подборе аналогов, поставка прототипов;
- Система менеджмента качества сертифицирована по Международному стандарту ISO 9001;
- Лицензия ФСБ на осуществление работ с использованием сведений, составляющих государственную тайну;
- Поставка специализированных компонентов (Xilinx, Altera, Analog Devices, Intersil, Interpoint, Microsemi, Aeroflex, Peregrine, Syfer, Eurofarad, Texas Instrument, Miteq, Cobham, E2V, MA-COM, Hittite, Mini-Circuits, General Dynamics и др.);

Помимо этого, одним из направлений компании «ЭлектроПласт» является направление «Источники питания». Мы предлагаем Вам помощь Конструкторского отдела:

- Подбор оптимального решения, техническое обоснование при выборе компонента;
- Подбор аналогов;
- Консультации по применению компонента;
- Поставка образцов и прототипов;
- Техническая поддержка проекта;
- Защита от снятия компонента с производства.



#### Как с нами связаться

**Телефон:** 8 (812) 309 58 32 (многоканальный)

**Факс:** 8 (812) 320-02-42

**Электронная почта:** [org@eplast1.ru](mailto:org@eplast1.ru)

**Адрес:** 198099, г. Санкт-Петербург, ул. Калинина, дом 2, корпус 4, литера А.