

Accessories & Hardware

Contents

Part Number	Page
AT001s	Y4
AT100s	Y6
AT200s	Y7
AT400s	Y9
AT500s	Y14
AT600s	Y17
AT700s	Y19
AT2100s	Y19
AT3000s	Y20
AT4000s	Y23
AT4100s	Y27
AT9000s	Y34

Toggle

Rockers

Pushbuttons

Illuminated PB

Programmable

Keylocks

Rotaries

Slides

Tactiles

Tilt

Touch

Indicators

Accessories

Supplement

Y

Color Codes

A Black	F Green
B White	G Blue
C Red	H Gray
D Amber	J Clear
E Yellow	S Metallic Silver

Hardware Threading

Many hardware pieces are available in both metric and inch threading, and in such cases **M** (metric) and **H** (inch) are noted in the descriptions. The customer must select threading by placing an M or H after the basic AT part number. If the hardware is available only in metric or inch, no code is used in the description; threading is designated on the drawing.

Accessories & Hardware

Toggles

Rockers

Pushbuttons

Illuminated PB

Programmable

Keylocks

Rotaries

Slides

Tactiles

Tilt

Touch

Indicators

Accessories

Supplement

AT010s~ AT090s

* Available in Americas only

*** AT016**
16mm Hex Mounting Nut
Steel
Series: CKM



*** AT019**
19mm Hex Mounting Nut
Brass with nickel plating
Series: CKL



*** AT050**
Knurled Nut
Brass with nickel plating
Series: SB40



*** AT055**
Crossover Guard
Polypropylene
Series: KB



AT056
Dress Cap Nut
Brass with chrome plating
Series: M P S



AT056T
Threaded Through Dress Nut
Brass with chrome plating
Series: M P S



*** AT057**
Mounting Nut
Brass with zinc plating,
chromate finish
Series: KB



*** AT062**
.250" Wide Rocker
Polyamide
Colors: A B C
Series: A



*** AT063**
Gasket
Nitrile butadiene rubber
Color: A
Series: B Threaded Bushing



AT064-1
Panel Frame for Rocker & Paddle .365" Wide
Polyamide
Color: A
Series: M



AT064-2
Panel Frame for Rocker & Paddle .365" Wide
Polyamide
Color: A
Series: M

AT064-1 accommodates panel thickness 1.2 ~ 2.3mm (.047 ~ .090")



AT064-2 accommodates panel thickness 1.57 ~ 3.18mm (.062 ~ .125")



Color Codes: A Black B White C Red D Amber E Yellow F Green G Blue H Gray J Clear

Accessories & Hardware

AT065-1
Panel Frame for Rocker & Paddle .450" Wide
 Polyamide
 Color: A
 Series: M



AT065-1 accommodates
 panel thickness
 1.2 ~ 2.3mm
 (.047 ~ .090")



AT065-2
Panel Frame for Rocker & Paddle .450" Wide
 Polyamide
 Color: A
 Series: M

*** AT066**
.300" Wide Rocker
 Polyamide
 Color: A B C
 Series: A



AT065-2 accommodates
 panel thickness
 1.57 ~ 3.18mm
 (.062 ~ .125")



*** AT070**
LED for AT208 Bezel
 Colors: C F
 Series: EB M MB24



*** AT073**
Mounting Nut
 Brass with nickel plating
 Series: HB



*** AT074**
Mounting Nut for LB Panel Seal
 Brass with chrome
 Series: LB



*** AT075**
O-ring for LB Panel Seal
 Nitrile butadiene rubber
 Series: LB



AT080
Screw Adaptor for AT452 & AT454
 Brass
 Series: MB20 SCB



AT089
O-ring for YB Panel Seal
 Nitrile butadiene rubber
 Series: YB



*** AT092**
Knurled Mounting Nut
 Glass fiber reinforced PBT
 Series: YB YB2



Color Codes: A Black B White C Red D Amber E Yellow F Green G Blue H Gray J Clear

Accessories & Hardware

Toggles

Rockers

Pushbuttons

Illuminated PB

Programmable

Keylocks

Rotaries

Slides

Tactiles

Tilt

Touch

Indicators

Accessories

Supplement

*** AT094**

PC Adaptor

Holder: Polypropylene
 Spring: Spring steel with nickel plating
 PC Pins: Brass with nickel plating
 Series: DSA01



*** AT097** ← **NEW**

JST Connector for OLED Rocker

JST Part No. BM12B-SURS
 PCB Mount
 Series: SmartSwitch



AT100s

AT105

Cap Removal Tool

Stainless steel
 Series: HB KB LB UB YB



AT106

Socket Wrench

Aluminum with black alumite finish
 Series: YB YB2



AT107

Lamp Extractor

Polyvinyl chloride
 Series: KB LW MLW YB



AT108

Socket Wrench

Aluminum with black alumite finish
 Series: KB



AT109

Cap Extractor

Stainless steel
 Series: HB KB LB UB YB



Color Codes: A Black B White C Red D Amber E Yellow F Green G Blue H Gray J Clear

Accessories & Hardware

AT110
Socket Wrench
 Brass
 Series: HB



AT111
Lamping Tool
 Stainless steel
 Series: HB KB YB



AT112
Socket Wrench
 Brass with nickel plating
 Series: LB



AT200s

AT201
ON-OFF Plate for 12mm Threaded Bushing
 Brass with nickel plating
 Series: M P S



AT202
ON-OFF Plate for 12mm Threaded Bushing
 Aluminum
 Colors: Red & black enamel
 Series: M P S



AT204
Bezel
 Polycarbonate
 Colors: A B C D E F G H
 Series: MLW



AT206
Bezel
 Polycarbonate
 Colors: A B C D E F G H
 Series: LW



AT207
Bezel
 Polycarbonate
 Colors: A B C E F G H
 Series: EB MB24 MB25



AT208
Bezel for AT070 LED
 Polycarbonate
 Color: A
 Series: EB M MB24 MB25



Color Codes: A Black B White C Red D Amber E Yellow F Green G Blue H Gray J Clear

Accessories & Hardware

Toggle

Rockers

Pushbuttons

Illuminated PB

Programmable

Keylocks

Rotaries

Slides

Tactiles

Tilt

Touch

Indicators

Accessories

Supplement

AT209
ON-OFF Plate for 6mm Threaded Bushing
 Brass with nickel plating
 Series: M P



AT210
ON-OFF Plate for 6mm Threaded Bushing
 Aluminum
 Colors: Red & black ink
 Series: M P



AT211
ON-OFF Plate for 6mm Threaded Bushing
 Aluminum
 Colors: Red & black enamel
 Series: M P



AT212
Bezel for 2 AT617 LEDs
 Polycarbonate
 Color: A
 Series: EB M MB24 MB25



AT213
Bezel for 2 AT618 LEDs
 Polycarbonate
 Color: A
 Series: EB M MB24 MB25



AT214
ON-OFF Plate for 12mm Threaded Bushing
 Aluminum
 Colors: Red & black ink
 Series: M P S



AT215
ON-OFF Plate for 12mm Threaded Bushing
 Aluminum
 Colors: Red & black enamel
 Series: M P S



AT217
Barrier
 Polyamide
 Colors: A B H
 Series: JWM



AT218
Barrier
 Polyamide
 Colors: A B H
 Series: JWJ



AT219
Barrier
 Polyamide
 Colors: A
 Series: JWS



Color Codes: A Black B White C Red D Amber E Yellow F Green G Blue H Gray J Clear

AT400s

AT401A/H/S
Splashproof Boot Assembly
 Hex Nut Material & Finish:
 Nickel plated brass
 O-ring Material:
 Nitrile butadiene rubber
 Series: M P S WT



AT401A for Oil Resistance
 Boot Material: Black nitrile butadiene rubber

AT401H for Dust & Ozone Resistance
 Boot Material: Gray ethylene propylene rubber

AT401S for Flexibility, Resilience, and Tensile Strength over Wide Temperature Range
 Boot Material: Black silicone rubber

For 12mm Bushings in M, P, S and WT Toggles

Boot Assembly Instructions

1. After mounting boot AT401 over toggle, press into place.
2. Be sure boot is pressed evenly and firmly down at or below height (A) as shown.



Switch Installation Instructions

1. Install switch bushing into mounting hole of panel from the back and adjust bushing to protrude 3.5 ~ 5.5mm (.138 ~ .217") above panel.
2. Install boot over bushing and tighten with hex nut.

Non-Splashproof Switches

M, P or S Toggles with 12mm Bushings

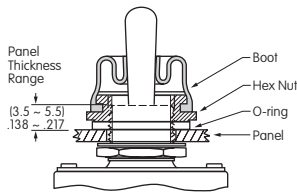

Use boot, nut and o-ring as shown. Use lockwasher and hexagon nut (from standard switch hardware) behind panel.

Splashproof Switches

S1AW ~ S29AW S Toggles

WT Toggles or M Toggle with B3 Bushing



Use boot, nut and o-ring as shown. Use o-ring only (from standard switch hardware) behind panel.

AT401P
O-ring
 Nitrile butadiene rubber
 Color: A
 Series: M MB20 TL WB WT



AT402
Splashproof Boot
 Silicon rubber for A C E F
 Ethylene propylene rubber for H
 Colors: A C E F H
 Series: M P S

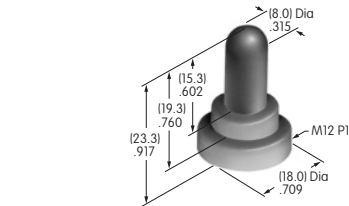

AT402S
Splashproof Boot
 Silicon rubber
 Color: A
 Series: M

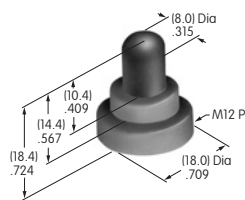

AT405
Solid Color Rocker
 Polycarbonate
 Colors: A B C D E F G
 Series: MLW



Color Codes: A Black B White C Red D Amber E Yellow F Green G Blue H Gray J Clear

Accessories & Hardware

Toggle

Rocker

Pushbutton

Illuminated PB

Programmable

Keylocks

Rotaries

Slides

Tactiles

Tilt

Touch

Indicators

Accessories

Supplement

AT406

Bat Lever Cap
Polyvinyl chloride
Colors: A B C E F G
Series: M P S



AT407

.394" Diameter Screw-on Cap
PBT
Colors: A B C E F G H
Series: MB20



AT412

.748" Diameter Screw-on Cap
Polystyrene
Colors: A B C F
Series: MB20 SCB WB



AT413

.315" Diameter Screw-on Cap
PBT
Colors: A B C E F G H
Series: MB20



AT414

.520" Diameter Screw-on Cap
PBT
Colors: A B C D E F G H
Series: MB20 SB SCB WB



AT415

Bat Lever Cap
Polyethylene
Colors: A B C E F G
Series: D2 M



AT416

Lamp Cover for AT602
Silicon rubber
Colors: C D F
Series: LW



AT420

Rocker
Polycarbonate
Colors: B J
Series: LW



AT421

Filter for AT420
Polycarbonate
Colors: B C D E F G
Series: LW



AT422

Slip-on Cap
Polyethylene
Colors: A B C E F G
Series: SB40



AT426

Solid Color Paddle
Polycarbonate
Colors: A B C D E F G
Series: MLW



AT427

Cap for Locking Lever (code L)
Brass with bright nickel plating (supplied with switch)
Anodized aluminum
Colors: A C G
Series: D2 M



Color Codes: A Black B White C Red D Amber E Yellow F Green G Blue H Gray J Clear

Accessories & Hardware

AT428 (M-metric H-inch)

Splashproof Boot
Silicone rubber
Color: A
Series: D2 M P



AT429

Indicator Cap
Polycarbonate
Colors: B C D E F G
Series: P01



AT431

Large Rotary Knob
Phenolic resin
Color: A
Series: HS PS TS



AT432

Small Rotary Knob
Phenolic resin
Color: A
Series: HS PS TS



AT433

Knob for Miniature Rotaries
Polyacetal
Color: A
Series: FR01 MR



AT434

Bat Lever Cap
Polyvinyl chloride
Colors: A B C E F G
Series: M



AT435

Screw-on Cap
Brass with chrome plating
Series: SB265



AT438

Design Rocker
Polycarbonate
Colors: B C D F G
Series: MLW



AT442

.394" Diameter Snap-on Cap
Polycarbonate
Colors: A B C E F G H
Series: DB EB M2B MB20 MB25

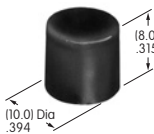

AT443

.315" Diameter Snap-on Cap
Polycarbonate
Colors: A B C E F G H
Series: DB EB M2B MB20 MB25

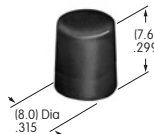

AT444

Bat Lever Conical Cap
Polyethylene
Colors: A B C E F G
Series: D2 M M2T



AT445

Cap for Color Tipped Cone Toggle
Polycarbonate
Colors: A B C E F G
Series: M



Color Codes: A Black B White C Red D Amber E Yellow F Green G Blue H Gray J Clear

Accessories & Hardware

Toggles

Rockers

Pushbuttons

Illuminated PB

Programmable

Keylocks

Rotaries

Slides

Tactiles

Tilt

Touch

Indicators

Accessories

Supplement

AT452
Rectangular Insert
 Polycarbonate
 Colors: A B C F G H
 Series: MB20 SCB
 Used with Screw Adaptor AT080



AT453
Rectangular Shroud
 Polycarbonate
 Colors: A B H
 Series: MB20 SCB



AT454
Round Insert
 Polycarbonate
 Colors: A B C F G H
 Series: MB20 SCB
 Used with Screw Adaptor AT080



AT455
Round Shroud
 Polycarbonate
 Colors: A B H
 Series: MB20 SCB



AT460
Cap for Color Capped Cone Toggle
 Polyethylene
 Colors: A B C E F G
 Series: M



AT465
.453" Square Cap
 Polycarbonate
 Colors: A B C E F G H
 Series: EB MB24 MB25



AT466
.453" False Illuminated Rocker
 Polycarbonate
 Cap Color: A
 Window Color: B/C
 Series: M



AT467
Short Paddle
 Polyamide
 Colors: A B C E F G H
 Series: A



AT468
Long Paddle
 Polyamide
 Colors: A B C E F G H
 Series: A



AT469
.260" Wide Rocker
 Polyamide
 Colors: A B C E F G H
 Series: A



AT475
.201" Diameter Cap
 Polyamide
 Colors: A B C
 Series: AB BB FB M2B MB24



AT476
Square Solid Colored Cap
 Polycarbonate
 Colors: BJ CJ EJ FJ GJ
 Series: LB



Color Codes: A Black B White C Red D Amber E Yellow F Green G Blue H Gray J Clear

Accessories & Hardware

AT477

Square Colored Insert Cap
Polycarbonate
Colors: JB JC JE JF JG
Series: LB



AT480

Square Spot Illuminated Cap
Polycarbonate
Cap Colors: A B C F
LED Colors: C D F CF
Series: LB



AT484

Square Nonilluminated Cap
Polycarbonate
Colors: A B C E F G H
Series: LB



AT485

Square Solid Colored Cap
Polycarbonate
Colors: A BB CB CC EB
FB FF GB GG
Series: KB



AT486

Round Solid Colored Cap
Polycarbonate
Colors: A BB CB CC EB
FB FF GB GG
Series: KB



AT487

Square Colored Insert Cap
Polycarbonate
Colors: JB JC JE JF JG
Series: KB



AT488

Round Colored Insert Cap
Polycarbonate
Colors: JB JC JE JF JG
Series: KB



AT494

Protective Guard
Cover: Polycarbonate
Base: Polyamide
Series: KB



AT495

Dust Cover
Lid: Polyvinyl chloride
Base: Polyamide
Series: KB



AT496

.295" Diameter Cap
Polyamide
Colors: A B C
Series: AB BB FB M2B MB24



AT497

End Barrier
Polyamide
Color: A
Series: LB



AT498

Center Barrier
Polyamide
Color: A
Series: LB



Color Codes: A Black B White C Red D Amber E Yellow F Green G Blue H Gray J Clear

Accessories & Hardware

Toggle

Rockers

Pushbuttons

Illuminated PB

Programmable

Keylocks

Rotaries

Slides

Tactiles

Tilt

Touch

Indicators

Accessories

Supplement

AT499
Protective Guard for Square
 Cover: Polycarbonate
 Base: Polyamide
 Series: LB



AT500s

AT501 (M-metric H-inch)
Knurled Face Nut
 Brass with chrome plating
 Series: D2 DB EB M MB20
 MB24 P



AT503 (M-metric H-inch)
Hex Face Nut
 Brass with chrome plating
 Series: M P S SB WB WT



AT504M
Knurled Face Nut
 Brass with chrome plating
 Series: M P S SB SCB
 WB WT

AT506M
Locking Ring
 Steel with zinc/chromate
 Series: M MB20 P S SB

AT507 (M-metric H-inch)
Locking Ring
 Steel with zinc/chromate
 Series: D2 DB EB M MB20
 MB24 MB25 MR P

AT508
Internal Tooth Lockwasher
 Steel with zinc/chromate
 Series: M P S SB SCB
 SK TL WB WT



AT509
Internal Tooth Lockwasher
 Steel with zinc/chromate
 Series: D2 DB EB FR01 M
 MB25 MR P S SB

AT512 (M-metric H-inch)
Conical Nut
 Brass with chrome plating
 Series: EB MB20

AT512C (M-metric H-inch)
Conical Nut
 Brass with chrome plating
 Series: EB MB20

AT513H
Hex Nut
 Brass with nickel plating
 Series: M MB20 MB24



Color Codes: A Black B White C Red D Amber E Yellow F Green G Blue H Gray J Clear

Accessories & Hardware

AT513M

Hex Nut

Brass with nickel plating
Series: B D2 DB EB FRO1 M
MB20 MB25 MR P



AT515 (M-metric H-inch)

Locking Ring for D Flat Bushing

Steel with zinc/chromate
Series: FRO1 M MB24



AT516

O-ring

Nitrile butadiene rubber
Series: M MB20



AT518

Locking Ring

Steel with zinc/chromate
Series: HS PS TS



AT520

Split Lockwasher

Steel with zinc/chromate
Series: HS PS TS

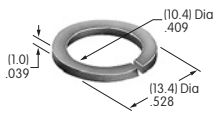

AT526

Hex Mounting Nut

Steel with nickel plating
Series: HS PS TS



AT527 (M-metric H-inch)

Hex Mounting Nut

Steel with nickel plating
Series: M P S SB SCB
SK TL



AT527MA

Black Hex Face Nut

Steel with black chrome plating
Series: TL



AT529

Mounter for Square Cap

Stainless steel frame
GFR PBT spacer
Series: EB



AT530

Panel Mount for Single Pole

Polyamide & polyacetel
Colors: A B C E F G H
Series: A AB



AT531

Panel Mount for Single or Double Pole

Polyamide & polyacetel
Colors: A B C E F G H
Series: A AB



AT532 (M-metric H-inch)

Dress Cap Nut

Brass with nickel plating
Series: EB M MB20 MB24 P



Color Codes: A Black B White C Red D Amber E Yellow F Green G Blue H Gray J Clear

Accessories & Hardware

Toggle

Rockers

Pushbuttons

Illuminated PB

Programmable

Keylocks

Rotaries

Slides

Tactiles

Tilt

Touch

Indicators

Accessories

Supplement

AT532T (M-metric H-inch)
Threaded Through Dress Nut
 Brass with nickel plating
 Series: EB M MB20 MB24 P



AT533T (M-metric H-inch)
Threaded Through Dress Nut
 Brass with nickel plating
 Series: EB M MB20 MB24 P



AT535
Rubber Ring for MR Panel Seal
 Nitrile butadiene rubber
 Series: MRB MRK



AT536
Hex Nut
 Brass with nickel plating
 Series: FB



AT537
O-ring
 Nitrile butadiene rubber
 Series: S

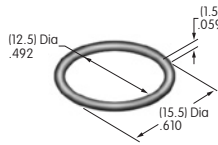

AT541
O-ring for Panel Seal with AT4115
 Nitrile butadiene rubber
 Series: YB

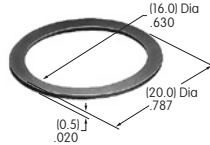

AT542
Coupler for LCD 36 x 24 Pushbutton
 PBT
 Series: SmartSwitch



AT543
Support Bracket
 Steel with tin plating
 Series: MRK

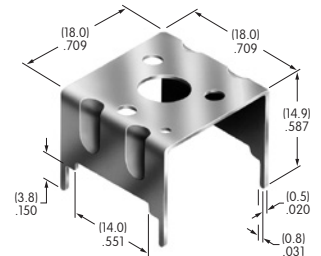

AT545
Locking Ring
 Steel with zinc/chromate
 Series: MRA MRB MRK



AT546
Mounting Bracket for Block Mounting
 Phosphor bronze with tin plating
 Series: GB2



AT547
Mounter for AT4140
 Polyamide
 Color: A
 Series: JB



AT548
Panel Mount Housing for LCD 36 x 24 Pushbutton (not for Compact SmartSwitch)
 Polyamide
 Color: A
 Series: SmartSwitch

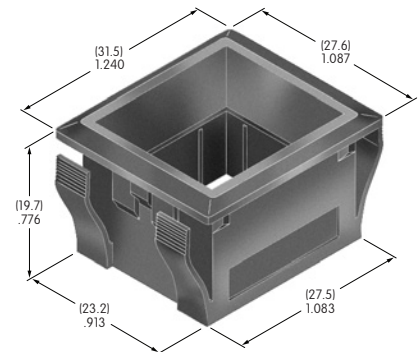

Color Codes: A Black B White C Red D Amber E Yellow F Green G Blue H Gray J Clear

Accessories & Hardware

AT600s

AT602
Incandescent Lamp
Volts: 6 12 18 24 28
Series: LW MLW
T-1 1/2 Pilot Slide Base



AT602N
Neon Lamp
Volts: 110
Series: LW MLW
T-1 1/2 Pilot Slide Base



AT607
Incandescent Lamp
Volts: 5 12
Series: LB
T-1 Bi-pin



AT607N
Neon Lamp
Volts: 110
Series: LB
T-1 Bi-pin



AT611
Incandescent Lamp
Volts: 5 12
Series: KB YB
T-1 Bi-pin



AT615
Neon Lamp
Volts: 110
Series: KB
T-1 Bi-pin



AT617
Single Element LED
Colors: C E F
Used for AT212 Bezel



AT618
Single Element LED
Colors: C E F
Used for AT213 Bezel



AT621
6-element Bicolor LED
Without Resistor; Volts: 2
With Resistor; Volts: 5 12 24
Colors: CF
Series: YB
T-1 1/2 Bi-pin



AT622
Single Element LED
Colors: C E F
Series: MLW
T-1 3/4 Pilot Slide Base



AT624
Single Element LED
Color: G
Series: HB
T-1 Bi-pin



Color Codes: A Black B White C Red D Amber E Yellow F Green G Blue H Gray J Clear

Accessories & Hardware

Toggle

Rockers

Pushbuttons

Illuminated PB

Programmable

Keylocks

Rotaries

Slides

Tactiles

Tilt

Touch

Indicators

Accessories

Supplement

AT625

**Super Bright
Single Element LED**
Color: G
Series: KB LB YB YB2
T-1 Bi-pin



AT627

**Bright
4-Element LED**
With Resistor; Volts: 5 12 24
Colors: C D F
Series: LB
T-1 Bi-pin



AT628

**Bright
Double Element LED**
Colors: C D F
Series: YB YB2
T-1 Bi-pin



AT629

Single Element LED
Color: B
Series: HB
T-1 Bi-pin



AT630

Single Element LED
Color: F
Series: HB
T-1 Bi-pin



AT631

**Super Bright
Single Element LED**
Color: B
Series: KB LB YB YB2
T-1 Bi-pin



AT632

**Super Bright
Single Element LED**
Color: F
Series: KB LB YB YB2
T-1 Bi-pin



AT633

Single Element LED
Colors: C D F
Series: HB
T-1 Bi-pin



AT634

**Bright
2- or 4-Element LED**
With Resistor; Volts: 5 12 24
Colors: C D F
Series: KB YB YB2
T-1 1/4 Bi-pin



AT635

**Bright
Single Element LED**
Colors: C D F
Series: KB LB
T-1 1/2 Bi-pin



AT636 ← NEW

**Bright
Single Element LED**
With Resistor; Volts: 5 12 24
Color: F
Series: YB2
T-1 1/4 Bi-pin



Color Codes: A Black B White C Red D Amber E Yellow F Green G Blue H Gray J Clear

Accessories & Hardware

AT700s

AT701
Single Pole
Straight PC Adaptor
 Glass fiber
 reinforced polyamide
 Series: KB



AT702
Double Pole
Straight PC Adaptor
 Glass fiber
 reinforced polyamide
 Series: KB



AT711
Single Pole
Straight PC Adaptor
 Glass fiber
 reinforced polyamide
 Series: LB



AT712
Double Pole
Straight PC Adaptor
 Glass fiber reinforced polyamide
 Series: LB



AT713 ← **NEW**
Receptacle Connector
 Connects to RS232C
 Compatible with
 FTCS04B & FTCS05B (5-wire) or
 FTCS04A & FTCS04A2 (4 wire)
 Length: 19.7" (500.0mm)
 Series: FT



AT714 ← **NEW**
Receptacle Connector
 Connects to Power Source
 of Control Boards
 FTCS04B & FTCS05B (5-wire)
 Length: 19.7" (500.0mm)
 Series: FT



AT715 ← **NEW**
Connector Cable
 Cable for OLED Rocker
 Length: 19.7" (500.0mm)
 Series: SmartSwitch



AT2100s

AT2107
Bezel
 Polyamide
 Colors: A B E F G H
 Series: M M2100



Color Codes: A Black B White C Red D Amber E Yellow F Green G Blue H Gray J Clear

Accessories & Hardware

Toggles

Rockers

Pushbuttons

Illuminated PB

Programmable

Keylocks

Rotaries

Slides

Tactiles

Tilt

Touch

Indicators

Accessories

Supplement

AT3000s

AT3001
Square Solid Cap
 Polycarbonate
 Colors: BB CB EB FB GB
 Series: YB



AT3002
Round Solid Cap
 Polycarbonate
 Colors: BB CB EB FB GB
 Series: YB



AT3003
Rectangular Solid Cap
 Polycarbonate
 Colors: BB CB EB FB GB
 Series: YB



AT3004
Square Cap for Bright LED & Bicolor
 Polycarbonate
 Colors: JB JC JD JF
 Series: YB



AT3005
Round Cap for Bright LED & Bicolor
 Polycarbonate
 Colors: JB JC JD JF
 Series: YB

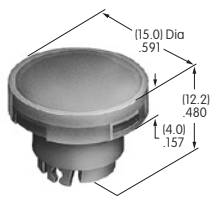

AT3006
Rectangular Cap for Bright LED & Bicolor
 Polycarbonate
 Colors: JB JC JD JF
 Series: YB



AT3010
Square Spot Illuminated Cap with Built-in LED
 Without Resistor; Volts: 2
 With Resistor; Volts: 5 12 24
 Polycarbonate
 Cap Colors: JA JB JC JE JF
 LED Colors: C D F CF
 Series: YB



AT3011
Round Spot Illuminated Cap with Built-in LED
 Without Resistor; Volts: 2
 With Resistor; Volts: 5 12 24
 Polycarbonate
 Cap Colors: JA JB JC JE JF
 LED Colors: C D F CF
 Series: YB



AT3012
Rectangular Spot Illuminated Cap with Built-in LED
 Without Resistor; Volts: 2
 With Resistor; Volts: 5 12 24
 Polycarbonate
 Cap Colors: JA JB JC JE JF
 LED Colors: C D F CF
 Series: YB

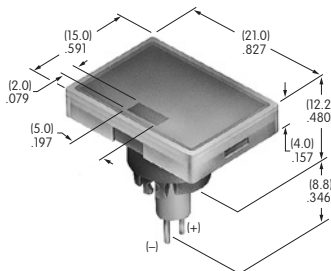

AT3014
Square Cap for Super Bright LED
 Polycarbonate
 Colors: JB
 Series: YB



AT3015
Round Cap for Super Bright LED
 Polycarbonate
 Colors: JB
 Series: YB



Color Codes: A Black B White C Red D Amber E Yellow F Green G Blue H Gray J Clear

Accessories & Hardware

AT3016
Rectangular Cap for Super Bright LED
 Polycarbonate
 Color: JB
 Series: YB



AT3017 ← **NEW**
Round Cap for Bright LED
 Polycarbonate
 Colors: JB CB EB FB
 Series: YB2



AT3018 ← **NEW**
Round Cap for Super Bright LED
 Polycarbonate
 Color: JB
 Series: YB2



AT3019 ← **NEW**
Round Solid Cap
 Polycarbonate
 Color: S (Metallic Silver)
 Series: YB2



AT3020 ← **NEW**
Round Cap for Bright or Super Bright LED with Clear Illumination Ring
 Lens: Polycarbonate
 Insert: Polyester
 Color: JS (Metallic Silver with Clear Ring)
 Series: YB2



AT3021
Flat Cap for Barrier Flange
 Polyphenylene oxide
 Colors: A B C H
 Series: JP



AT3022 ← **NEW**
Square Cap for Single or Bicolor LED
 Polycarbonate Resin
 Colors: JB JC JD JF
 Series: NP01



AT3023 ← **NEW**
Square Cap for Bicolor LED with Alternating Legends
 Polycarbonate Resin
 Color: J
 Series: NP01



AT3024 ← **NEW**
Square Solid Cap
 Polycarbonate Resin
 Colors: A B C H
 Series: NP01



AT3069
Sculptured Cap with Alternating Legend for Illuminated
 Polycarbonate
 Color: J
 Series: UB2



AT3070
Flat Cap with Alternating Legend for Illuminated
 Polycarbonate
 Color: J
 Series: UB2



AT3073
Sculptured Cap for Nonilluminated
 Polycarbonate
 Colors: JA JB JC JD JF
 Series: UB2



Color Codes: A Black B White C Red D Amber E Yellow F Green G Blue H Gray J Clear

Accessories & Hardware

Toggle

Rockers

Pushbuttons

Illuminated PB

Programmable

Keylocks

Rotaries

Slides

Tactiles

Tilt

Touch

Indicators

Accessories

Supplement

AT3074
Sculptured Cap for Illuminated
 Polycarbonate
 Colors: JB JC JD JF
 Series: UB2



AT3075
Beveled Cap for Illuminated
 Polycarbonate
 Colors: B C D F
 Series: UB2



AT3076
Flat Cap for Illuminated with Lens/Diffuser
 Polycarbonate
 Colors: JB JC JD JF
 Series: UB2



AT3077
Beveled Cap for Nonilluminated
 Polycarbonate
 Colors: A B C D F
 Series: UB2



AT3078
12mm Sculptured Cap with Lens/Diffuser
 Polycarbonate
 Colors: JB
 Series: KP



AT3079
15mm Sculptured Cap with Lens/Diffuser
 Polycarbonate
 Colors: JB
 Series: KP



AT3080
17.4mm Sculptured Cap with Lens/Diffuser
 Polycarbonate
 Colors: JB
 Series: KP



AT3081
Transparent Lens
 Polycarbonate
 Color: J
 Series: HB2



AT3082
Translucent Diffuser
 Polycarbonate
 Color: B
 Series: HB2



AT3083
12mm Flat Cap with Lens/Diffuser
 Polycarbonate
 Colors: JB
 Series: KP



AT3084
15mm Flat Cap with Lens/Diffuser
 Polycarbonate
 Colors: JB
 Series: KP



AT3085
17.4mm Flat Cap with Lens/Diffuser
 Polycarbonate
 Colors: JB
 Series: KP



Color Codes: A Black B White C Red D Amber E Yellow F Green G Blue H Gray J Clear

Accessories & Hardware

AT3086

12mm Home Key Cap with Lens/Diffuser

Polycarbonate
Colors: JB
Series: KP



AT3087

15mm Home Key Cap with Lens/Diffuser

Polycarbonate
Colors: JB
Series: KP



AT3088

17.4mm Home Key Cap with Lens/Diffuser

Polycarbonate
Colors: JB
Series: KP



AT4000s

AT4001

Square Dust Cover

Lid: Polyvinyl chloride
Gasket: Polyethylene
Series: LB UB



AT4002

Round Dust Cover

Lid: Polyvinyl chloride
Gasket: Polyethylene
Series: LB



AT4003

.394" Bat Lever Cap

Polyvinyl chloride
Colors: A B C
Series: A B



AT4011

Rectangular Dust Cover

Lid: Polyvinyl chloride
Gasket: Polyethylene
Series: LB UB



AT4012

Round Solid Colored Cap

Polycarbonate
Colors: BJ CJ EJ FJ GJ
Series: LB



AT4013

Round Colored Insert Cap

Polycarbonate
Colors: JB JC JE JF JG
Series: LB



AT4016

Round Spot Illuminated Cap

Polycarbonate
Cap Colors: A B C F
LED Colors: C D F CF
Series: LB



Color Codes: A Black B White C Red D Amber E Yellow F Green G Blue H Gray J Clear

Accessories & Hardware

Toggle

Rockers

Pushbuttons

Illuminated PB

Programmable

Keylocks

Rotaries

Slides

Tactiles

Tilt

Touch

Indicators

Accessories

Supplement

AT4017
Round Nonilluminated Cap
 Polycarbonate
 Colors: A B C E F G H
 Series: LB



AT4021
Rectangular Solid Colored Cap
 Polycarbonate
 Colors: A BB CB CC EB
 FB FF GB GG
 Series: KB



AT4022
Rectangular Colored Insert Cap
 Polycarbonate
 Cap Colors: JB JC JE JF JG
 Series: KB



AT4024
Protective Guard
 Cover: Polycarbonate
 Base: Polyamide
 Series: KB



AT4025
Rectangular Dust Cover
 Lid: Polyvinyl chloride
 Base: Polyamide
 Series: KB



AT4026
Rectangular Solid Colored Cap
 Polycarbonate
 Colors: BJ CJ EJ FJ GJ
 Series: LB



AT4027
Rectangular Colored Insert Cap
 Polycarbonate
 Colors: JB JC JE JF JG
 Series: LB



AT4030
Rectangular Nonilluminated Cap
 Polycarbonate
 Colors: A B C E F G H
 Series: LB



AT4031
Square Cap for Bright & Super Bright LED
 Polycarbonate
 Colors: JB
 Series: HB



AT4032
Round Cap for Bright & Super Bright LED
 Polycarbonate
 Colors: JB
 Series: HB



AT4033
Square Indicator Cap
 Polycarbonate
 Colors: JB
 Series: HB



AT4034
Round Indicator Cap
 Polycarbonate
 Colors: JB
 Series: HB



Color Codes: A Black B White C Red D Amber E Yellow F Green G Blue H Gray J Clear

Accessories & Hardware

AT4035
Square Nonilluminated Cap
 Polycarbonate
 Colors: A B C E F G
 Series: HB



AT4036
Round Nonilluminated Cap
 Polycarbonate
 Colors: B C E F G
 Series: HB



AT4041 (M-metric H-inch)
Splashproof Boot for Momentary
 Black silicone rubber
 Series: MB



AT4042 (M-metric H-inch)
Splashproof Boot for Alternate
 Black silicone rubber
 Series: MB



AT4043
Splashproof Boot
 Black silicone rubber
 Series: MB SB WB



AT4051
Spot Illuminated Cap
 Polycarbonate
 Colors: AB
 Series: KB



AT4052
Spot Illuminated Cap
 Polycarbonate
 Colors: AB
 Series: HB



AT4054
Round Solid Colored Cap
 Polycarbonate
 Colors: BJ CJ EJ FJ GJ
 Series: LB Panel Seal



AT4055
Round Colored Insert Cap
 Polycarbonate
 Colors: JB JC JE JF JG
 Series: LB Panel Seal



AT4057
Protective Guard
 Polycarbonate
 Series: LB



AT4058
Sculptured Cap
 Polyamide
 Colors: A B C E F G H
 Series: JB



Color Codes: A Black B White C Red D Amber E Yellow F Green G Blue H Gray J Clear

Accessories & Hardware

Toggles

Rockers

Pushbuttons

Illuminated PB

Programmable

Keylocks

Rotaries

Slides

Tactiles

Tilt

Touch

Indicators

Accessories

Supplement

AT4059
Flat Cap
 Polycarbonate
 Colors: A B C E F G H
 Series: JB



AT4060
Clear Cap with Colored Diffuser
 Polycarbonate
 Colors: JB JC JE JF
 Series: JB



AT4062
Rocker
 Polyamide
 Colors: A B C
 Series: G



AT4063
.157" Diameter Slip-on Cap
 Polyamide
 Colors: A B C
 Series: GB G3B



AT4064
.248" Bat Lever Cap
 Polyvinyl chloride
 Colors: A B C
 Series: A B



AT4065
Slide Cap
 Polycarbonate
 Cap Color: A
 Window: C E F
 Series: SS



AT4072
Protective Guard
 Lid: Polycarbonate
 Base: Glass fiber reinforced polycarbonate
 Series: YB



AT4073
Square Opaque Cap for Nonilluminated
 Polycarbonate
 Colors: A B C E F G
 Series: UB



AT4074
Square Transparent Cap for Illuminated
 Polycarbonate
 Colors: C D F J
 Series: UB



AT4075
Diffuser for AT4074 Square Cap
 Polycarbonate
 Colors: B C D F
 Series: UB



AT4076
Button with Frame for Illuminated
 Polycarbonate
 Colors: BB BC BE BF BH
 Series: JB



AT4077
Button for Nonilluminated
 Polycarbonate
 Colors: B C E F G H
 Series: JB



Color Codes: A Black B White C Red D Amber E Yellow F Green G Blue H Gray J Clear

Accessories & Hardware

AT4078

Frame for AT4077
Polycarbonate
Colors: B C E F G H
Series: JB

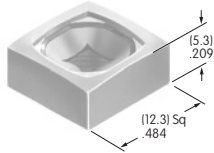

AT4079

Actuator Key
Brass alloy with
bright nickel plating
Series: SK

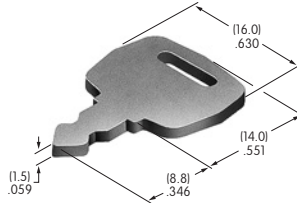

AT4080

Actuator Key
Brass alloy with
bright nickel plating
Antistatic ABS resin handle
Color: A
Series: SK



AT4081

Actuator Key
Zinc alloy with chrome plating
Series: SK



AT4082

Actuator Key
Zinc alloy with chrome plating
Series: SK

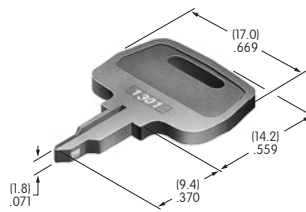

AT4094

Actuator Key
Polyacetal
Color: A
Series: SK



AT4100s

AT4103

Small Color Tipped Knob
Polyester with polyamide tip
Base Color: A
Tip Colors: A B C E F G H
Series: FR01 MR



AT4104

Large Color Tipped Knob
Polyester with polyamide tip
Base Color: A
Tip Colors: A B C E F G H
Series: FR01 MR



AT4115

Dust Cover
Lid: Polyvinyl chloride
Base: Polyamide
Series: YB

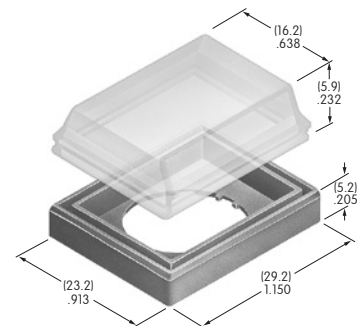

Color Codes: A Black B White C Red D Amber E Yellow F Green G Blue H Gray J Clear

Accessories & Hardware

Toggle

Rocker

Pushbutton

Illuminated PB

Programmable

Keylocks

Rotaries

Slides

Tactiles

Tilt

Touch

Indicators

Accessories

Supplement

AT4116
Rectangular Opaque Cap for Nonilluminated
 Polycarbonate
 Colors: A B C E F G
 Series: UB



AT4117
Rectangular Transparent Cap for Illuminated
 Polycarbonate
 Colors: C D F J
 Series: UB



AT4118
Diffuser for AT4117 Rectangular Transparent Cap
 Polycarbonate
 Colors: B C D F
 Series: UB



AT4119
Square Spot Illuminated Cap
 Polycarbonate
 Colors: AB
 Series: UB

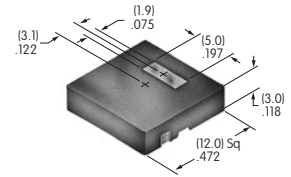

AT4120
Rectangular Spot Illuminated Cap
 Polycarbonate
 Colors: AB
 Series: UB

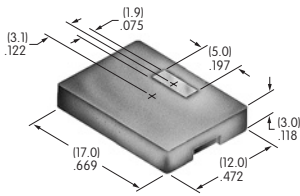

AT4124
Actuator Key
 Brass with nickel plating
 Series: SK

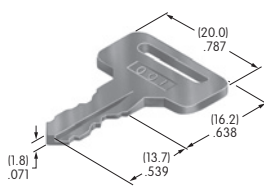

AT4125
LED Rocker
 Polycarbonate
 Colors: B C E F
 Series: MLW

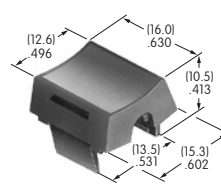

AT4126
Dust Cover
 Polyvinyl chloride & polyamide
 Color: A
 Series: JWJ

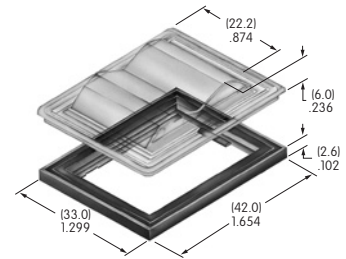

AT4127
Sculptured Rocker
 Polycarbonate
 Colors: B C E F
 Series: MLW



AT4128
Round Cap for Super Bright LED
 Polycarbonate
 Colors: JB
 Series: LB



AT4129
Square Cap for Super Bright LED
 Polycarbonate
 Colors: JB
 Series: LB



AT4130
Rectangular Cap for Super Bright LED
 Polycarbonate
 Colors: JB
 Series: LB

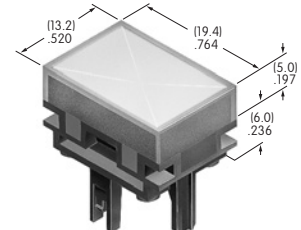

Color Codes: A Black B White C Red D Amber E Yellow F Green G Blue H Gray J Clear

Accessories & Hardware

AT4131
Round Cap for Super Bright LED
 Polycarbonate
 Colors: JB
 Series: LB Panel Seal



AT4132
Round Cap for Bright & Super Bright LED
 Polycarbonate
 Colors: JB
 Series: KB



AT4133
Square Cap for Bright & Super Bright LED
 Polycarbonate
 Colors: JB
 Series: KB



AT4134
Rectangular Cap for Bright & Super Bright LED
 Polycarbonate
 Colors: JB
 Series: KB



AT4135
Frosted Cap with White Base
 Polycarbonate
 Colors: B C E F
 Series: JB



AT4137
Rectangular Cap
 PBT
 Colors: A B C
 Series: GB2



AT4139
Square Flat Cap
 Polycarbonate
 Colors: A B C H
 Series: JB



AT4140
Cap for Mounter AT547
 Polycarbonate
 Colors: A B C H
 Series: JB



AT4141
Protective Guard
 Cover: Polycarbonate
 Base: GFR polyamide
 Series: UB2



AT4142
Spring Loaded Protective Guard
 Cover: Polycarbonate
 Base: GFR polyamide
 Coil spring: Stainless steel
 Series: UB2



AT4143
End Barrier
 Polyamide
 Color: A
 Series: UB2



AT4144
Center Barrier
 Polyamide
 Color: A
 Series: UB2



Color Codes: A Black B White C Red D Amber E Yellow F Green G Blue H Gray J Clear

Accessories & Hardware

Toggle

Rockers

Pushbuttons

Illuminated PB

Programmable

Keylocks

Rotaries

Slides

Tactiles

Tilt

Touch

Indicators

Accessories

Supplement

AT4145
Square Dust Cover
 Lid: PVC
 Gasket: Polyethylene
 Series: UB2



AT4146
Tubular Key
 Brass with nickel plating
 ABS handle
 Color: A
 Series: CKM



AT4147
Flat Key
 Brass with nickel plating
 ABS handle
 Color: A
 Series: CKM



AT4148
.365" Wide Rocker
 Polyamide
 Colors: A B C E F G H
 Series: M M2T P



AT4149
.365" Wide Paddle
 Polyamide
 Colors: A B C E F G H
 Series: M M2T P



AT4150
.450" Wide Rocker
 Polyamide
 Colors: A B C E F G H
 Series: M M2T



AT4151
.450" Wide Paddle
 Polyamide
 Colors: A B C E F G H
 Series: M M2T



AT4152
Tubular Key
 Brass with nickel plating
 Series: CKL

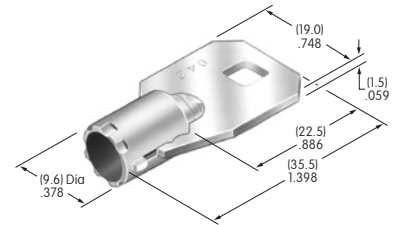

AT4153
Flat Key
 Brass with chrome plating
 Series: CKL



AT4156
.595" Wide Rocker
 Polyamide
 Colors: A B C E F G H
 Series: M P



AT4157
.595" Wide Paddle
 Polyamide
 Colors: A B C E F G H
 Series: M P



Color Codes: A Black B White C Red D Amber E Yellow F Green G Blue H Gray J Clear

Accessories & Hardware

AT4158

Square Cap for Bright LED
Polycarbonate
Colors: JC JD JF
Series: KB



AT4159

Rectangular Cap for Bright LED
Polycarbonate
Colors: JC JD JF
Series: KB



AT4160

Round Cap for Bright LED
Polycarbonate
Colors: JC JD JF
Series: KB



AT4162

Square Cap for Bright LED
Polycarbonate
Colors: JB JC JD JF
Series: LB



AT4163

Rectangular Cap for Bright LED
Polycarbonate
Colors: JB JC JD JF
Series: LB



AT4164

Round Cap for Bright LED
Polycarbonate
Colors: JB JC JD JF
Series: LB



AT4165

Round Cap for Bright LED
Polycarbonate
Colors: JB JC JD JF
Series: LB Panel Seal



AT4166

Square Cap for Bright LED
Polycarbonate
Colors: CB DB FB
Series: HB



AT4167

Round Cap for Bright LED
Polycarbonate
Colors: CB DB FB
Series: HB



AT4168

Square Indicator Cap for Bright LED
Polycarbonate
Colors: CB DB FB
Series: HB



AT4169

Round Indicator Cap for Bright LED
Polycarbonate
Colors: CB DB FB
Series: HB



Color Codes: A Black B White C Red D Amber E Yellow F Green G Blue H Gray J Clear

Accessories & Hardware

Toggle

Rockers

Pushbuttons

Illuminated PB

Programmable

Keylocks

Rotaries

Slides

Tactiles

Tilt

Touch

Indicators

Accessories

Supplement

AT4170
Spring Loaded Protective Guard
 Cover: Polycarbonate
 Base: Polyamide
 Coil spring: Stainless steel
 Series: UB2



AT4171
Spring Loaded Protective Guard
 Cover: Polycarbonate
 Base: Polyamide
 Coil spring: Stainless steel
 Series: LB UB



AT4172
Spring Loaded Protective Guard
 Cover: Polycarbonate
 Base: Polyamide
 Coil spring: Stainless steel
 Series: LB UB



AT4173
Spring Loaded Protective Guard
 Cover: Polycarbonate
 Base: Polyamide
 Coil spring: Stainless steel
 Series: UB



AT4174
Spring Loaded Protective Guard
 Cover: Polycarbonate
 Base: Polyamide
 Coil spring: Stainless steel
 Series: UB



AT4175
Spring Loaded Protective Guard
 Cover: Polycarbonate
 Base: Glass fiber reinforced polyamide
 Coil spring: Stainless steel
 Series: YB



AT4176
Square Cap for Bright LED
 Polycarbonate
 Colors: JB JC JD JF
 Series: LB



AT4177
Rectangular Cap for Bright LED
 Polycarbonate
 Colors: JB JC JD JF
 Series: LB



AT4178
Round Cap for Bright LED
 Polycarbonate
 Colors: JB JC JD JF
 Series: LB



Color Codes: A Black B White C Red D Amber E Yellow F Green G Blue H Gray J Clear

AT4179

Round Cap for Bright LED

Polycarbonate
Colors: JB JC JD JF
Series: LB Panel Seal



AT4180

Snap-on Knob

Polyamide
Knob: Black
Flange: Transparent brown
Series: FRO1



AT4181 ← NEW

Splashproof Boot Assembly

Boot Material: Black silicon rubber
Hex Nut Material & Finish:
Nickel plated brass
O-ring Material:
Nitrile butadiene rubber
Series: M P S WT

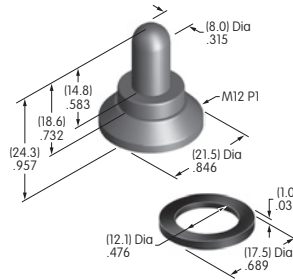

Switch Installation Instructions

1. Install switch bushing into mounting hole of panel from the back and adjust bushing to protrude 3.5 ~ 5.5mm (.138 ~ .217").
2. Install o-ring on bushing and tighten nut from above.
3. Insert boot onto nut. Be sure the boot and nut are a firm, secure fit.

Non-Splashproof Switches

M, P or S Toggles with 12mm Bushings



Use boot, nut and o-ring as shown. Use lockwasher and hexagon nut (from standard switch hardware) behind panel.

For 12mm Bushings in M, P, S & WT Toggles

Boot & Nut Assembly Instructions

1. Stretch base of the boot to fit around outer edges of the nut.
2. The ridge inside of boot must be firmly seated in groove of the nut.
3. Moving all around perimeter, push (with about 10N of force) toward center to assure boot seals tightly into groove (with no air pockets).



Splashproof Switches

S1AW ~ S29AW S Toggles

WT Toggles or M Toggle with B3 Bushing



Use boot, nut and o-ring as shown. Use o-ring only (from standard switch hardware) behind panel.

Series or Part Numbers	Panel Thickness (Maximum)
<ul style="list-style-type: none"> • M Series B2 Toggles with 12mm B1 & B3 Bushings • P Series B Toggles with 12mm Bushing • S31 ~ 39, S41 ~ 49, S31F ~ 33F, S41F ~ S43F, S31T ~ 33T, S41T ~ 43T • S301 ~ 309, S331 ~ 339, S301F, S331F ~ 333F, S335F, S301T ~ 309T, S331T ~ 339T • S421 ~ 429, S421T ~ 429 	5.0mm (.197")
<ul style="list-style-type: none"> • WT11S ~ 29S, WT11T ~ 29T, WT11L ~ 29L 	3.5mm (.138")
<ul style="list-style-type: none"> • S1A ~ 7A, S21A, S1F ~ 7F, S21F • S114, S116 • S1AW ~ 9AW, S21AW, S25AW ~ 29AW 	3.0mm (.118")

Color Codes: A Black B White C Red D Amber E Yellow F Green G Blue H Gray J Clear

Accessories & Hardware

Toggle

Rockers

Pushbuttons

Illuminated PB

Programmable

Keylocks

Rotaries

Slides

Tactiles

Tilt

Touch

Indicators

Accessories

Supplement



AT9201
Bezel
 Polycarbonate
 Colors: A B C D E F G H
 Series: MLW



AT9410
Round Splash Cover
 Lid: Polyvinyl chloride
 Base: Polyethylene
 O-ring: Nitrile butadiene rubber
 Series: LB Panel Seal



AT9704-02YC
Socket for LCD 36 x 24
Single & Bicolor Pushbutton
 Base: Glass fiber reinforced PBT
 Terminals: Brass/beryllium copper
 Series: SmartSwitch



AT9704-065E ← **NEW**
Socket for LCD 36 x 24
RGB Pushbutton
 Base: Glass fiber reinforced PBT
 Terminals: Brass/beryllium copper
 Series: SmartSwitch



AT9704-065F
Socket for LCD 36 x 24
Compact Pushbutton
 Base: Glass fiber reinforced PBT
 Terminals: Brass/beryllium copper
 Series: SmartSwitch



Note: By extracting some of the pins, socket may be used for the **64 x 32 Compact Pushbutton**

AT9704-085K ← **NEW**
Socket for LCD 64 x 32 Pushbutton
 Base: Glass fiber reinforced PBT
 Terminals: Brass/beryllium copper
 Series: SmartSwitch



AT9704-085L ← **NEW**
Socket for OLED 64 x 48 Pushbutton
 Base: Glass fiber reinforced PBT
 Terminals: Brass/beryllium copper
 Series: SmartSwitch



AT9704-085M ← **NEW**
Socket for OLED 52 x 36 Display
 Base: Glass fiber reinforced PBT
 Terminals: Brass/beryllium copper
 Series: SmartSwitch



Color Codes: A Black B White C Red D Amber E Yellow F Green G Blue H Gray J Clear



Компания «ЭлектроПласт» предлагает заключение долгосрочных отношений при поставках импортных электронных компонентов на взаимовыгодных условиях!

Наши преимущества:

- Оперативные поставки широкого спектра электронных компонентов отечественного и импортного производства напрямую от производителей и с крупнейших мировых складов;
- Поставка более 17-ти миллионов наименований электронных компонентов;
- Поставка сложных, дефицитных, либо снятых с производства позиций;
- Оперативные сроки поставки под заказ (от 5 рабочих дней);
- Экспресс доставка в любую точку России;
- Техническая поддержка проекта, помощь в подборе аналогов, поставка прототипов;
- Система менеджмента качества сертифицирована по Международному стандарту ISO 9001;
- Лицензия ФСБ на осуществление работ с использованием сведений, составляющих государственную тайну;
- Поставка специализированных компонентов (Xilinx, Altera, Analog Devices, Intersil, Interpoint, Microsemi, Aeroflex, Peregrine, Syfer, Eurofarad, Texas Instrument, Miteq, Cobham, E2V, MA-COM, Hittite, Mini-Circuits, General Dynamics и др.);

Помимо этого, одним из направлений компании «ЭлектроПласт» является направление «Источники питания». Мы предлагаем Вам помощь Конструкторского отдела:

- Подбор оптимального решения, техническое обоснование при выборе компонента;
- Подбор аналогов;
- Консультации по применению компонента;
- Поставка образцов и прототипов;
- Техническая поддержка проекта;
- Защита от снятия компонента с производства.



Как с нами связаться

Телефон: 8 (812) 309 58 32 (многоканальный)

Факс: 8 (812) 320-02-42

Электронная почта: org@eplast1.ru

Адрес: 198099, г. Санкт-Петербург, ул. Калинина, дом 2, корпус 4, литера А.