

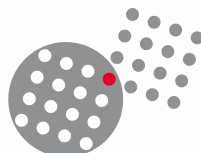

8D Series

MIL-DTL-38999 Series III



SOURIAU
Connection Technology



Contents

Overview

- MIL-DTL-38999: A universal product platform 04
- 8D Series - Presentation 05
- Product overview 06
- A superior concept 07
- A performing MIL standard connector design 08
- Technical features & benefits 09
- Contact layouts 11
- Contact layouts (matrix) 15

Standard Series

- **Aluminum Series**
 - Part numbers 18
 - Dimensions 20
 - Backshells 23
 - Dummy receptacle 28
 - Caps 29
 - Connectors weight 30
- **Composite Series**
 - Part numbers 32
 - Dimensions 34
 - Backshells 36
 - Connectors weight 37
- **Stainless Steel Series**
 - Part numbers 40
 - Dimensions 42
 - Connectors weight 45
- **Titanium Series**
 - Part numbers 48
 - Dimensions 49
 - Connectors weight 52
- **Bronze Series**
 - Part numbers 54
 - Dimensions 55
 - Backshells 58
 - Dummy receptacle 62
 - Caps 63

Common Section

- Contents 64
- Orientations 65
- Panel cut-out 65
- Crimp contacts 66
- Straight PC tail contacts 68
- Coaxial contacts #12 69
- Solder cup 69
- Crimp contacts: 1500 mating 69
- Wire wrap contacts 69
- Quadrax #8 contacts 69
- Thermocouple contacts 70
- Dummy contacts 70
- Filler plugs 70
- Insertion and extraction tools 71
- Crimping tools 71
- Wiring instruction 72
- Gaskets 74
- Plastic protective caps 74

Derived Series

- Reinforced sealing Series 75
- Hermetic Series 77
- Clinch nuts 81
- Double flange 85
- Optical ELIO® Contacts 91
- RJ45/USB Series 101

Range Extension

- 8D8 / 8D9 Series 110
- 8DB bulkhead feedthrough 110
- 8D hermetic ELIO® feedthrough 111
- 8D hermetic aluminum power & signal connector 111
- Coordinates for straight PC tail terminations 112



MIL-DTL-38999: A universal product platform



Series I: 8LT Series

- ▶ High density (#22D) MIL-spec circular (1980's)
- ▶ Scoop proof
- ▶ Coupling system: Bayonet
- ▶ Method of mounting: screws or jam nut
- ▶ Shell: Aluminum alloy
- ▶ Plating: olive green cadmium or nickel
- ▶ QPL approved
- ▶ Numerous layouts



Series I.5: 8ST Series

- ▶ High density - same layouts as 38999 Series I
- ▶ Lightweight version of Series I
- ▶ Scoop proof, bayonet coupling
- ▶ Method of mounting: screws or jam nut
- ▶ Shell: Aluminum alloy
- ▶ Plating: olive green cadmium or nickel
- ▶ VG 96912 German specification
- ▶ JN 1003 Typhoon specification



Series II: 8T Series

- ▶ Short version of MIL-DTL-38999 Series I
- ▶ Low profile = lightweight
- ▶ High density MIL-spec circular (1980's)
- ▶ Non-scoop proof, bayonet coupling
- ▶ Method of mounting: screws or jam nut
- ▶ Shell: Aluminum alloy
- ▶ Plating: olive green cadmium, nickel, hard anodized
- ▶ QPL approved
- ▶ Numerous layouts

8D Series - MIL-DTL-38999 Series III



8D Series - Presentation

38999 Series III: 8D Series

Since the early 80's, Souriau is a major supplier of 38999 Series III, the screw-coupled version of MIL-C-38999. Present on the main international programs, Souriau has developed a range of products that meet the performance required in extreme environments:

- Civil and military aeronautics
- Ground military
- Industrial
- Marine and offshore

This evolution of MIL-C-38999 allows:

- A high contact density up to 128 contacts #22D
- A quick screw coupling with self locking mechanism
- High resistance to harsh environments (vibration, 200°C)

Always at the cutting edge of innovation, Souriau's teams have continuously improved this range of connectors:

- Composite version in the 90's (Its choice is recommended wherever weight is critical)
- Titanium version for weight saving and very high and mechanical resistance
- Today Souriau remains innovative with cadmium free and RoHS solutions.
In 2009 Souriau was the first to be QPL qualified for Zinc Nickel plating.

This product family is in accordance with MIL-DTL-38999 Series III, EN 3645, CECC (standard for bronze shell), ... and also meets many customers' standards (Rolls Royce, ABS, BACC, ...)



8D Series - Product overview

Standard Series

- ▶ 5 different materials
- ▶ A full platform that matches any environment
- ▶ Different platings (including RoHS & Cadmium free platings)

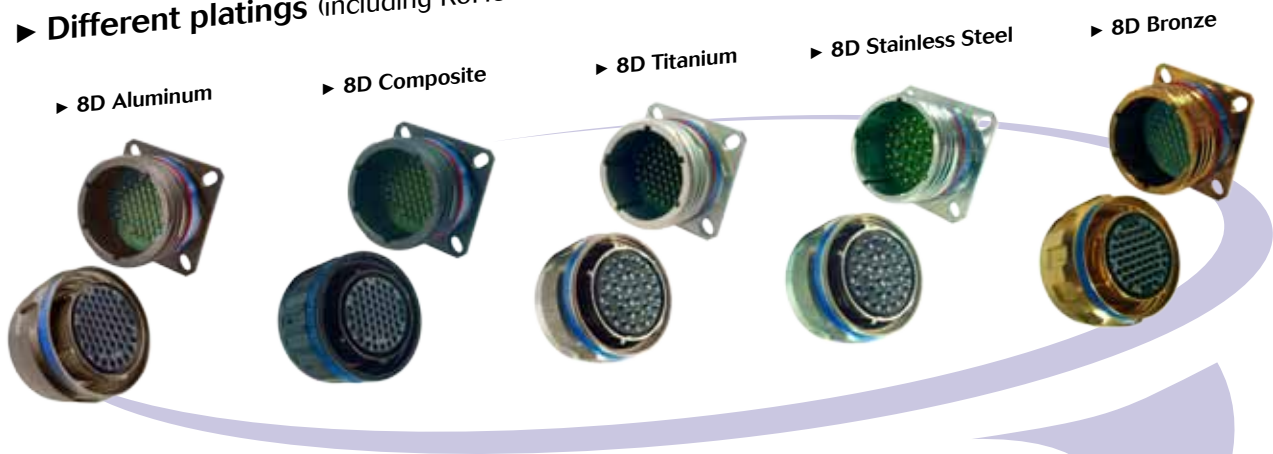

Derived Series

- ▶ Various possibilities of range extension & shell variant from Standard Series
- ▶ The only limit is your imagination: Consult us !

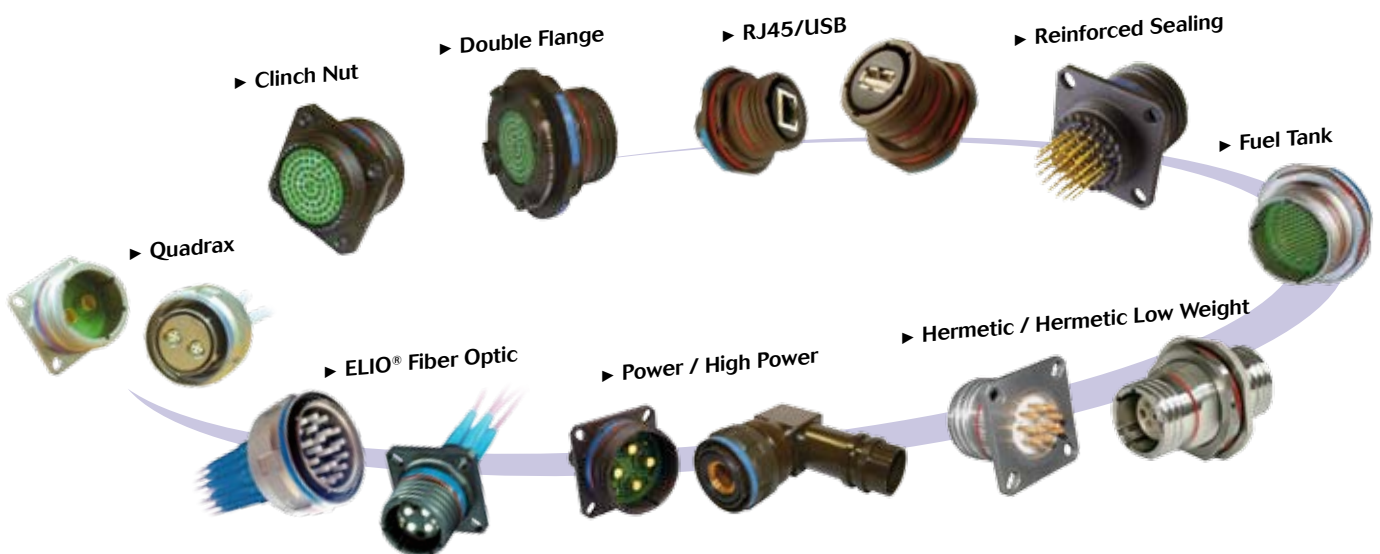

8D Series - MIL-DTL-38999 Series III



8D Series - A superior concept

A full range of contact

► Multi-contact technology provides versatile connectors

► Signal transmission

► High speed data transmission
► Quadrax ► Triax ► Coax ► ELIO® fiber optic

► High power transmission

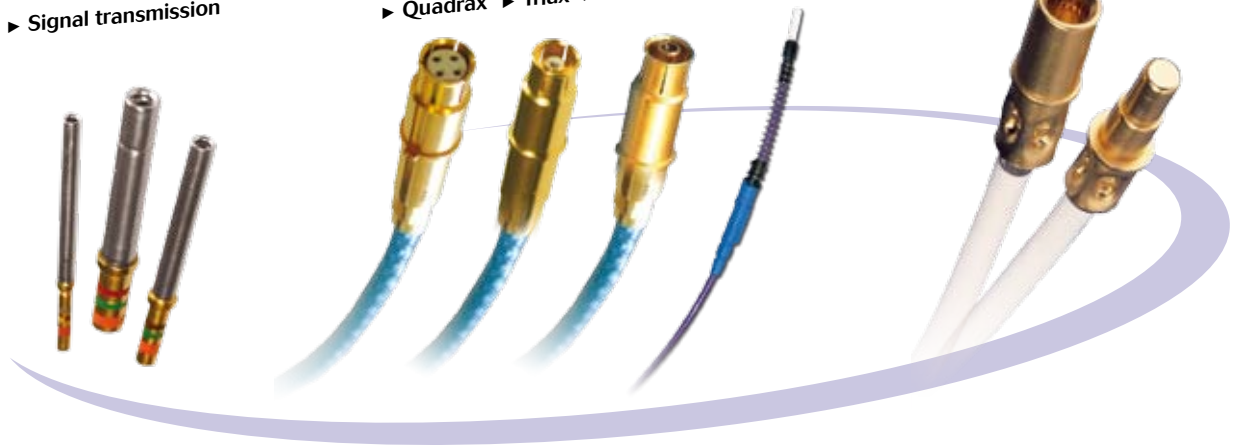

► Various contact styles

► Crimp ► Solder cup ► PC tails ► Wire wrap

► Common cavity for all #8 contacts

Metal clips patented by Souriau

► Unique clip retention technology

► High performance contact retention system:

- Insure high temperature withstanding
- Provides superior strenght in vibrations
- Better retention characteristics than plastic clips

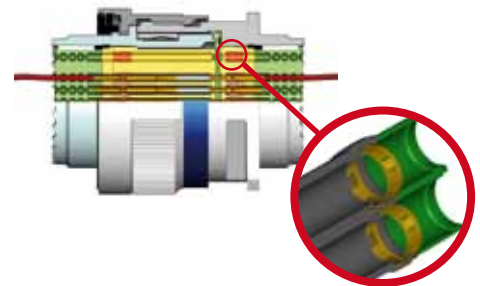

High performance sealing (IP67)

► Each contact cavity is individually sealed

Accessories available

► Protective caps, backshells, tools, ...



A performing MIL standard connector design

Scoop proof connector

- ▶ No risk of damaging the contact during the coupling operation

Unique self locking mechanism

- ▶ Connector will never unscrew even under high vibration (44g)

Visual mating indication

- ▶ Red band visible = not correctly mated



- ▶ Red band hidden = correctly mated



Quick screw coupling

- ▶ 1 1/4 turn to mate



Fully shielded connector

- ▶ 360° shielding

360° teeth for optimum shield continuity with accessories

EMI Ring



- ▶ Shell to shell bottoming = perfect shield continuity

8D Series - MIL-DTL-38999 Series III



Description

- High contact density
- Screw coupling
- Contact protection: 100% Scoop proof
- Shell size from 9 to 25
- Accessories available (protective caps, backshells, etc...)
- RFI - EMI shielding and shell to shell continuity
- Hermetic
- Protected by cadmium, nickel, green zinc cobalt or black zinc nickel plating

Applications

- Civil and Military Aerospace
- Marine and Offshore Equipment
- Defense and Ground Military
- Industrial

Standards

- MIL-DTL-38999 Series III
- EN3645
- BACC63CT/CU; BACC63DB/DC

Technical features

Mechanical

- **Shell:**
Aluminum, composite, stainless steel, bronze
- **Shells plating:**
 - . Aluminum shell:
 - Cadmium olive drab (W)
 - Nickel (F)
 - Black zinc nickel (Z)
 - Green zinc cobalt (ZO)
 - . Composite shell:
 - Cadmium olive drab (J)
 - Nickel (M)
 - Without plating (X)

- . Stainless steel shell:
 - Passivated (K)
 - Nickel (S)
 - . Titanium shell:
 - Without plating (TT)
 - Nickel (TF)
 - . Bronze shell:
 - Without plating
 - **Insulator:** Thermoplastic
 - **Grommet and interfacial seal:** Silicone elastomer
 - **Contacts:** Copper alloy
 - **Contacts plating:** Gold over nickel plated
 - **Endurance:**
 - . 500 mating/unmating operations whatever the material used
 - . 1500 mating/unmating operations with composite connectors + specifics contacts
 - **Shock:** 300g, 3 ms according EN 2591-D2 method A
 - **Vibration:**
 - . Sinus:
 - . 10 à 2000 Hz, 3x12 hrs (60g, 140 - 2000 Hz) with T° cycling
 - . Random:
 - . 50 to 2000 Hz, 2x8 Hrs (1g2/ Hz, 100 - 2000Hz) at T° max.
 - . 25 to 2000 Hz, 2x8 Hrs (5g2/ Hz, 100 - 300Hz) at ambient T°
- Test with accessories in acc with EN2591-D3

• Contact retention:

Contacts size	22	20	16	12	8	4
Min force in N	44	67	111	111	111	200

Weight comparison

Example for a plug shell size 15

Materials	Weight	
Stainless steel	58.80 g	42% lighter
Titanium	33.90 g	
Aluminum	20.35 g	40% lighter
Composite	14.30 g	
		30% lighter

8D Series - MIL-DTL-38999 Series III



Electrical

• Test voltage rating (Vrms)

Service	sea level	at 21000 m
M	1 300	800
N	1 000	600
I	1 800	1 000
II	2 300	1 000

• Contact resistance

Contacts size	22	20	16	12	8	4
Resistance mΩ	14.6	7.3	3.8	3.5	3	2

• Insulation resistance:

≥ 5 000 MΩ (under 500 Vdc)

• Contact rating:

Contacts size	22	20	16	12	8	4
Rating (A)	5	7.5	13	23	45	80

• Shell continuity

- . Aluminum shell:
 - Cadmium olive drab (W): 2.5 Ωh
 - Nickel (F): 1 Ωh
 - Black zinc nickel (Z): 2.5 Ωh
 - Green zinc cobalt (ZC): 2.5 Ωh
- . Composite shell:
 - Cadmium olive drab (J): 3 Ωh
 - Nickel (M): 3 Ωh
- . Stainless steel shell:
 - Passivated (K): 10 Ωh
 - Nickel (S): 1 Ωh
- . Titanium shell:
 - Without plating (TT): 10 Ωh
 - Nickel (TF): 1 Ωh
- . Bronze shell:
 - Without plating: 5 Ωh

• Shielding:

- . Aluminum shell:
 - F: 65 db at 10 GHz
 - F: 85 db at 1 GHz
 - W: 50 db at 10 GHz
 - Z & ZC: Consult us
- . Composite shell:
 - J: 90 db at 10 GHz
 - M: 85 db at 1 GHz
- . Stainless steel shell:
 - K: 45 db at 10 GHz
 - S: 65 db at 10 GHz
- . Titanium shell:
 - TT: 45 db at 10 GHz
 - TF: 65 db at 10 GHz
- . Bronze shell:
 - 85 db at 10 GHz

Climatics

• Temperature range:

- . Aluminum shell:
 - W: -65°C +175°C
 - F: -65°C +200°C
 - Z: -65°C +200°C
 - ZC: -65°C +200°C
- . Composite shell:
 - J: -65°C +175°C
 - M: -65°C +200°C
 - Without plating (X): -65°C +175°C
- . Stainless steel shell:
 - K: -65°C +200°C
 - S: -65°C +200°C
- . Titanium shell:
 - TT: -65°C +200°C
 - TF: -65°C +200°C
- . Bronze shell:
 - Without plating: -65°C +175°C

• Sealing:

Mated connectors meet altitude immersion requirements of MIL-DTL-38999.

• Salt spray:

- . Aluminum shell:
 - W: 500 Hrs
 - F: 48 Hrs
 - Z: 500 Hrs
 - ZC: 500 Hrs
- . Composite shell:
 - J: 2000 Hrs
 - M: 2000 Hrs
 - Without plating (X): 2000 Hrs
- . Stainless steel shell:
 - K: 500 Hrs
 - S: 48 Hrs
- . Titanium shell:
 - TT: 500 Hrs
 - TF: 48 Hrs
- . Bronze shell:
 - Without plating: 500 Hrs

Resistance to fluids

• According to MIL-DTL-38999 standard

- . Gasoline: JP5 (OTAN F44)
- . Mineral hydrolic fluid: MIL-H-5606 (OTAN H515)
- . Synthetic hydraulic fluid: Skydrol 500 B4

• LD4 (SAE AS 1241)

- . Mineral lubricating: MIL-L-7870A (OTAN 0142)
- . Synthetic lubricating: MIL-L-23699 (OTAN 0156), MIL-L-7808
- . Cleaning fluid: MIL-DTL-25769 diluted
- . De-icing fluid: MIL-A-8243
- . Extinguishing fluid: Chlorobrométhane
- . Cooling fluid: Coolanol









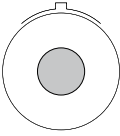
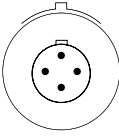
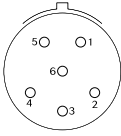
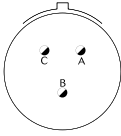

8D Series - MIL-DTL-38999 Series III



Contact layouts

09 / A

01  1 Optical position	05  1#8 Quadrax	35  6#22D Service M	98  3#20 Service I
--	---	---	--

-  Contact #22D
-  Contact #20
-  Contact #16
-  Contact #12
-  Contact #10
-  Contact #8 Triax
-  Contact #8 Power
-  Contact #8 Quadrax
-  Contact ELIO® (optical fiber)
-  Contact #4 Power

11 / B

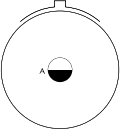
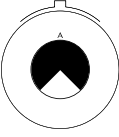
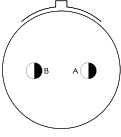
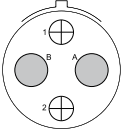
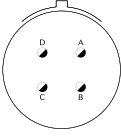
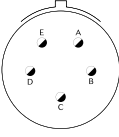
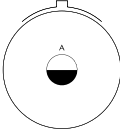
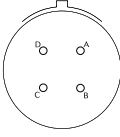
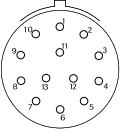
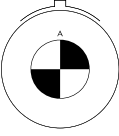
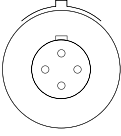
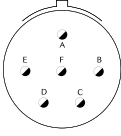
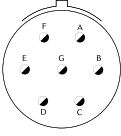
01  1#12 Service II all series excepted JVS	01  1#8 Coax Service I only for JVS	02  2#16 Service I	02  2 Optical positions	04  4#20 Service I	05  5#20 Service I	12  1#12 Service II only for JVS	22  4#22D Service M
35  13#22D Service M	80  1#8 Triax Service I	81  1#8 Quadrax	98  6#20 Service I	99  7#20 Service I			

13 / C

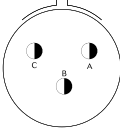
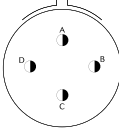
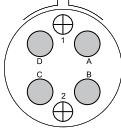
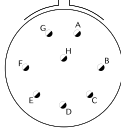
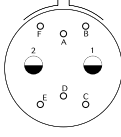
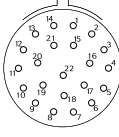
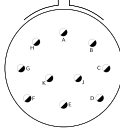
03  3#16 Service I	04  4#16 Service I	04  4 Optical positions	08  8#20 Service I	26  2#12 6#22D Service M	35  22#22D Service M	98  10#20 Service I
--	--	---	--	---	---	---

 ELIO® fiber optic  Ethernet Quadrax

8D Series - MIL-DTL-38999 Series III



Contact layouts

15 / D

05 5#16 Service II	15 1#16 14#20 Service I	18 18#20 Service I	19 19#20 Service I	35 37#22D Service M	97 4#16 8#20 Service I
-------------------------------------	---	-------------------------------------	-------------------------------------	--------------------------------------	--

17 / E

02 38#22D 1#8 Triax Service M	06 6#12 Service I	08 8#16 Service II	20 4#12 16#22D Service M	22 2#12 2#8 Triax Service M	26 26#20 Service I	35 55#22D Service M	75 2#8 Triax Service M	
80 2#12 2#8 Quadrax	81 38#22D 1#8 Quadrax	82 2#8 Quadrax	99 2#16 21#20 Service I					

19 / F

08 8 Optical positions	11 11#16 Service II	18 14#22D 4#8 Triax Service M	28 26#20 2#16 Service I	32 32#20 Service I	35 66#22D Service M	53* 53#22D	84 14#22D 4#8 Quadrax
---	--------------------------------------	---	---	-------------------------------------	--------------------------------------	--------------------------	--

ELIO® fiber optic Ethernet Quadrax * Pending layout

8D Series - MIL-DTL-38999 Series III



Contact layouts

21 / G

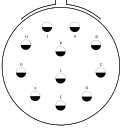
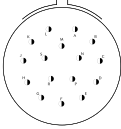
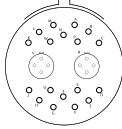
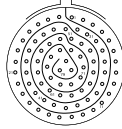
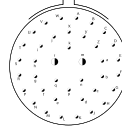
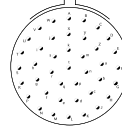
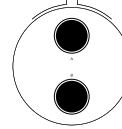
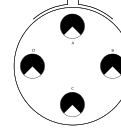
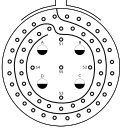
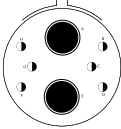
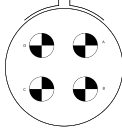
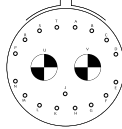
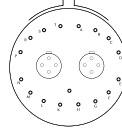
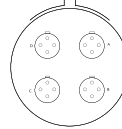
11  11#12 Service I	16  16#16 Service II	20*  18#20 2#8 Quadrax	35  79#22D Service M	39  2#16 37#20 Service I	41  41#20 Service I	42  2#4 Power Service I	48  4#8 Power Service I
59  55#22D 4#12 Service M	72  2#4 Power 6#16 Service I	75  4#8 Triax Service M	77  17#22D 2#8 Coax Service M	<div style="background-color: #cccccc; padding: 2px;">78</div>  17#22D 2#8 Quadrax	<div style="background-color: #cccccc; padding: 2px;">84</div>  4#8 Quadrax		

23 / H

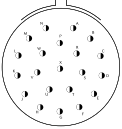
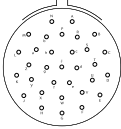
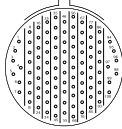
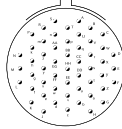
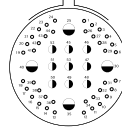
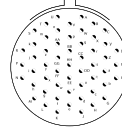
21  21#16 Service II	32  32#20 Service I	35  100#22D Service M	53  53#20 Service I	54  4#12, 9#16 40#22D Service M	55  55#20 Service I
---	--	--	--	---	---

8D Series - MIL-DTL-38999 Series III



Contact layouts

25 / J							
<p>04</p> <p>8#16 48#20 Service I</p>	<p>07</p> <p>2#8 Triax 97#22D Service M</p>	<p>08</p> <p>8#8 Triax Service M</p>	<p>11</p> <p>2#20 9#10 Service N</p>	<p>17</p> <p>36#22D 6#8 Triax</p>	<p>19</p> <p>19#12 Service I</p>	<p>20*</p> <p>10#20, 13#16 4#12 Coax 3#8 Triax Service N</p>	<p>24</p> <p>12#16 12#12 Service II</p>
<p>24</p> <p>24 Optical positions</p>	<p>29</p> <p>29#16 Service I</p>	<p>35</p> <p>128#22D Service M</p>	<p>37</p> <p>37#16 Service I</p>	<p>41</p> <p>22#22D, 3#20 11#16, 2#12 3#8 Triax Service M</p>	<p>43</p> <p>23#20 20#16 Service I</p>	<p>44</p> <p>4#4 Power 4#16 Service I</p>	<p>46</p> <p>40#20, 4#16 2#8 Coax Service I</p>
<p>61</p> <p>61#20 Service I</p>	<p>80</p> <p>10#20 13#16 4#12 Coax 3#8 Quadrax</p>	<p>81</p> <p>22#22D 3#20, 11#16 2#12 3#8 Quadrax</p>	<p>82</p> <p>97#22D 2#8 Quadrax</p>	<p>86</p> <p>40#20 4#16 2#8 Quadrax</p>	<p>87</p> <p>36#22D 6#8 Quadrax</p>	<p>88</p> <p>8#8 Quadrax</p>	<p>90</p> <p>40#20, 4#16 2#8 Twinax Service I</p>

ELIO® fiber optic
 Ethernet Quadrax
 * For classes F, W, K, S only

8D Series - MIL-DTL-38999 Series III



Contact layouts

Shell size	Layout	MIL-DTL-38999 (QPL) Aluminum, Stainless steel & Composite	8D Titanium	JVS (CECC) Bronze connectors	Hermetics	EN3645	BACC63 CT/CU DB/DC	Number of contacts	#22D	#20	#16	#12	#10	#8	#4 Power	Optical posi- tions
09 / A	09-01							1								1
	09-05 (1)	Consult us	Consult us	Consult us				1						1 Qdx		
	09-35							6	6							
	09-98							3		3						
11 / B	11-01							1				1				
	11-01							1						1 Coax		
	11-02							2			2					
	11-02							2								2
	11-04							4		4						
	11-05							5		5						
	11-12							1				1				
	11-22							4	4							
	11-35							13	13							
	11-80							1						1 Triax		
	11-81							1						1 Qdx		
11-98							6		6							
11-99							7		7							
13 / C	13-03							3								
	13-04							4			4					
	13-04							4								4
	13-08							8		8						
	13-26							8	6			2				
	13-35							22	22							
13-98							10		10							
15 / D	15-05							5			5					
	15-15							15		14	1					
	15-18							18		18						
	15-19							19		19						
	15-35							37	37							
	15-97							12		8	4					
17 / E	17-02							39	38					1 Triax		
	17-06							6				6				
	17-08							8			8					
	17-20							20	16			4				
	17-22							4				2		2 Triax		
	17-26							26		26						
	17-35							55	55							
	17-75							2						2 Triax		
	17-80							4				2		2 Qdx		
	17-81							39	38					1 Qdx		
17-82							2						2 Qdx			
17-99							23		21	2						
19 / F	19-08							8								8
	19-11							11			11					
	19-18							18	14					4 Triax		
	19-28							28		26	2					
	19-32							32		32						
	19-35							66	66							
	19-53							53	53							
19-84							18	14					4 Qdx			

Souriau's layout
 Souriau's layout & Layout according to corresponding norm

(1) Grounded insert only

#8 Pow: Power; Qdx: Quadrax; Twx: Twinax

8D Series - MIL-DTL-38999 Series III



Contact layouts

Shell size	Layout	MIL-DTL-38999 (QPL) Aluminum, Stainless steel & Composite	8D Titanium	JVS (CECC) Bronze connectors	Hermetics	EN3645	BACC63 CT/CU DB/DC	Number of contacts	#22D	#20	#16	#12	#10	#8	#4 Power	Optical posi- tions	
21 / G	21-11							11				11					
	21-16							16			16						
	21-20							20		18				2 Qdx			
	21-35							79	79								
	21-39							39		37	2						
	21-41							41		41							
	21-42							2							2		
	21-48							4						4 Pow			
	21-59							59	55			4					
	21-72							8							2		
	21-75							4						4 Triax			
	21-77							19	17					2 Coax			
	21-78							19	17					2 Qdx			
21-84							4						4 Qdx				
23 / H	23-21							21			21						
	23-32							32		32							
	23-35							100	100								
	23-53							53		53							
	23-54							53	40		9	4					
	23-55							55		55							
25 / J	25-04							56		48	8						
	25-07							99	97					2 Triax			
	25-08			(2)				8						8 Triax			
	25-11							11		2			9				
	25-17							42	36					6 Triax			
	25-19							19				19					
	25-20	(3)		(4)		(5)	(6)	30		10	13	4		3 Triax			
	25-24							24			12	12					
	25-24							24								24	
	25-29							29			29						
	25-35							128	128								
	25-37							37			37						
	25-41							41	22	3	11	2		3 Triax			
	25-43							43		23	20						
	25-44							8			4				4		
	25-46							46		40	4			2 Coax			
	25-61							61		61							
	25-80							30		10	13	4		3 Qdx			
	25-81							41	22	3	11	2		3 Qdx			
	25-82							99	97					2 Qdx			
25-86							46		40	4			2 Qdx				
25-87							42	36					6 Qdx				
25-88							8						8 Qdx				
25-90							46		40	4			2 Twx				

- Souriau's layout
- Souriau's layout & Layout according to corresponding norm
- (2) For CECC, layout 25-08 only delivered without contact
- (3) For Aluminum & Stainless steel only
- (4) For classes F, W, S, K only
- (5) For classes F, W, K only
- (6) Qualified BACC63DB/DC only
- #8 Pow: Power; Qdx: Quadrax; Twx: Twinax



Aluminum Series

MIL-DTL-38999 Series III

8D - D38999 Aluminum Series



Connector part numbers

Basic Series	8D	0	-	11	W	35	P	N	-	-	L
Shell style:											
<ul style="list-style-type: none"> 0: Square flange receptacle 1: In line receptacle 7: Jam nut receptacle 5: Plug with RFI shielding 											
<i>Also available:</i>											
<ul style="list-style-type: none"> . Square flange receptacle with clinch nuts (see page 81) . Jam nut receptacle with double flange (see page 85) 											
Type:											
None: Connectors with standard crimp contacts.											
L: Receptacle with long PC tail (male and female size #22D, #20).											
C: Receptacle with short PC tail (male and female #22D, #20, #16).											
S: Receptacle with specific PC tail (male et female #22D)											
W: Receptacle with male contacts #22D for wire wrap (3 wraps)											
T: Receptacle with male contacts #20 for wire wrap (2 wraps)											
P: Receptacle with solder cup - only available for Reinforced sealing Series (see page 75) - male and female size #22D; male #16 & #12; female #16 & #12 and male female #20 please consult us											
Shell size: 09, 11, 13, 15, 17, 19, 21, 23, 25											
Plating:											
W: Olive drab cadmium											
F: Nickel											
ZC: Green zinc cobalt											
Z: Black zinc nickel											
Contact layout: See pages 11 to 14											
Contact type:											
P: Pin											
A: Connector supplied less pin contact or with specific contacts (connector marking: A + orientation)											
S: Socket											
B: Connector supplied less socket contact or with specific contacts (connector marking: B + orientation)											
Orientation: N, A, B, C, D, E (see page 65)											
Specification:											
046: Tinned straight PC tail											
251: Connector provided with power contacts (layouts with contact #8)											
022: Fuel tank											
Special custom:											
None: Standard plastic cap											
M: Antistatic plastic cap											
L: For P or S contact type only, connectors delivered without contacts, connectors marking P or S plus orientation											

8D - D38999 Aluminum Series



MIL-DTL-38999 part numbers*

Basic Series	D38999	20	W	B	35	P	N	L
Shell style:								
20: Square flange receptacle								
24: Jam nut receptacle								
26: Plug with RFI shielding.								
Plating:								
W: Olive drab cadmium								
F: Nickel								
Shell size: A, B, C, D, E, F, G, H, J								
Contact layout: See page 15 for layout according to MIL-DTL-38999								
Contact type:								
P: Pin								
A: Connector supplied less pin contact or with specific contacts (connector marking: A + orientation)								
S: Socket								
B: Connector supplied less socket contact or with specific contacts (connector marking: B + orientation)								
Orientation: N, A, B, C, D, E (see page 65)								
L: For P or S contact type only, connector delivered without contacts, connector marking P or S (without L)								

* Note: To place an order of MIL connectors delivered without MIL removable crimp contacts and keep P or S plus orientation marking, it must be specify clearly on the order (by adding a suffix L at the end of the P/N or specified in comment).

EN3645 part numbers

Basic Series	EN3645	W	6	G	N	35	B	N
Plating:								
W: Olive drab cadmium								
F: Nickel								
Shell style:								
0: Square flange receptacle								
6: Plug								
7: Jam nut receptacle								
Shell size:								
09=A, 11=B, 13=C, 15=D, 17=E, 19=F, 21=G, 23=H, 25=J								
Grounding:								
N: Standard insert not grounded								
Contact layout:								
See page 15 for layout according to EN3645								
Contact type:								
A: Connector supplied less pin contact								
B: Connector supplied less socket contact								
F: Socket								
M: Pin								
Orientation:								
N, A, B, C, D, E (see page 65)								

8D - D38999 Aluminum Series



Dimensions

Receptacle type 0										
	Shell size	A Max	B Max	C Max	D Thread	E ± 0.3	F	G	H ± 0.2	J ± 0.2
	09 (A)	20.9	10.72	2.5	M12 x 1-6g	23.8	18.26	15.09	3.25	5.49
11 (B)	M15 x 1-6g				26.2	20.62	18.26	4.93		
13 (C)	M18 x 1-6g				28.6	23.01	20.62	4.4		
15 (D)	M22 x 1-6g				31	24.61	23.01	4.93		
17 (E)	M25 x 1-6g				33.3	26.97	24.61			
19 (F)	M28 x 1-6g				36.5	29.36	26.97			
21 (G)	20.1	11.54	3.2	M31 x 1-6g	39.7	31.75	29.36	3.91	6.15	
23 (H)				M34 x 1-6g	42.9	34.93	31.75			
25 (J)				M37 x 1-6g	46	38.1	34.93			

Receptacle type 7								
	Shell size	A ± 0.15	B Max	C Max	D Max	E Max	F ± 0.4	G Thread
	09 (A)	16.53	9.9	3.2	30.5	23	27	M12 x 1-6g
11 (B)	19.07	35.2			26	31.8	M15 x 1-6g	
13 (C)	23.82	38.4			31	34.9	M18 x 1-6g	
15 (D)	26.97	41.6			34	38.1	M22 x 1-6g	
17 (E)	30.15	44.8			37	41.3	M25 x 1-6g	
19 (F)	33.32	49.5			41	46	M28 x 1-6g	
21 (G)	36.50	52.7			46	49.2	M31 x 1-6g	
23 (H)	39.67	55.9			47	52.4	M34 x 1-6g	
25 (J)	42.85	59			51.23	55.6	M37 x 1-6g	

Recommended coupling torque on panel for jam nut receptacle (type 7)

Shell	09 (A)	11 (B)	13 (C)	15 (D)	17 (E)	19 (F)	21 (G)	23 (H)	25 (J)
Coupling torque (± 0.5 N.m)	4	5	7	8	9	10	12	13	14

Note: All dimensions are in millimeters (mm)

8D - D38999 Aluminum Series



In line receptacle type 1

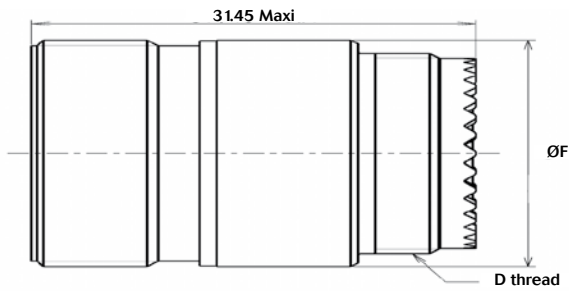

Shell size	D thread	Ø F
09 (A)	M12 x 1-6g	15.90
11 (B)	M15 x 1-6g	19.05
13 (C)	M18 x 1-6g	22.25
15 (D)	M22 x 1-6g	25.40
17 (E)	M25 x 1-6g	30.15
19 (F)	M28 x 1-6g	31.75
21 (G)	M31 x 1-6g	34.75
23 (H)	M34 x 1-6g	37.10
25 (J)	M37 x 1-6g	41.30

Plug type 5

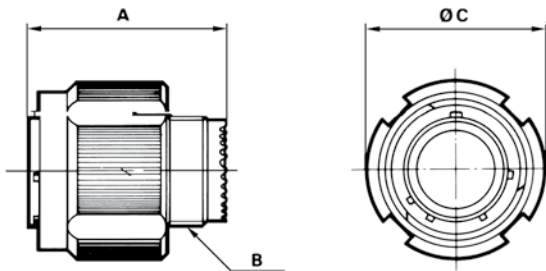

Shell size	A Max.	B thread	C Max.
09 (A)	31.00	M12 x 1-6g	21.80
11 (B)	31.00	M15 x 1-6g	25.00
13 (C)	31.00	M18 x 1-6g	29.40
15 (D)	31.00	M22 x 1-6g	32.50
17 (E)	31.00	M25 x 1-6g	35.70
19 (F)	31.00	M28 x 1-6g	38.50
21 (G)	31.00	M31 x 1-6g	41.70
23 (H)	31.00	M34 x 1-6g	44.90
25 (J)	31.00	M37 x 1-6g	48.00

Mated connectors dimensions

Type 0 with plug

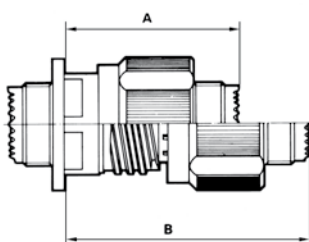

Type 7 with plug

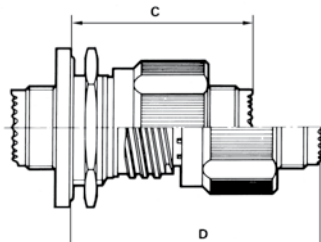

Shell size	A Max.	B Max.	C Max.	D Max.
09 (A)	37.00	52.30	38.30	53.60
11 (B)	37.00	52.30	38.30	53.60
13 (C)	37.00	52.30	38.50	53.80
15 (D)	37.00	52.30	38.50	53.80
17 (E)	37.00	52.30	38.50	53.80
19 (F)	37.00	52.30	38.50	53.80
21 (G)	36.00	51.30	38.50	53.80
23 (H)	36.00	51.30	38.50	53.80
25 (J)	36.00	51.30	38.50	53.80

Note: All dimensions are in millimeters (mm)

8D - D38999 Aluminum Series



Receptacle with straight PC tail contacts

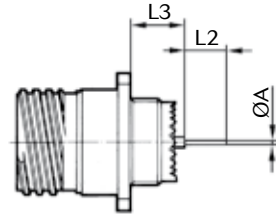
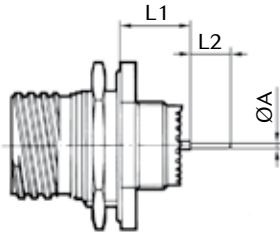

		Shell size			09 (A)	11 (B)	13 (C)	15 (C)	17 (E)	19 (F)	21 (G)	23 (H)	25 (J)
		Contact size	Contact type	PC tail type									
A		#22D	M & F	L & C	0.70								
		#22D	M & F	S	0.50								
		#20	M & F	C	0.70								
		#16	M & F	C	1.15								
L1	Min	#22D	M	L & C	10.52	10.34							
	Max	#22D	M	L & C	11.46	11.28							
	Min	#22D	F	L & C	10.19	10.01							
	Max	#22D	F	L & C	11.46	11.28							
	Min	#22D	M	S	10.19	10.01							
	Max	#22D	M	S	11.46	11.28							
	Min	#22D	F	S	10.69	10.51							
	Max	#22D	F	S	11.63	11.45							
	Min	#20	M	C	10.36	10.18							
	Max	#20	M	C	11.63	11.45							
	Min	#20	F	C	10.69	10.51							
	Max	#20	F	C	11.63	11.45							
	Min	#16	M	C	10.69	10.51							
	Max	#16	M	C	11.63	11.45							
	Min	#16	F	C	10.69	10.51							
	Max	#16	F	C	11.63	11.45							
L2		#22D	M & F	L	8.50								
		#22D	M & F	C	4.00								
		#22D	M & F	S	5.10								
		#20	M & F	C	5.10								
		#16	M & F	C	5.10								
L3	Min	#22D	M	L & C	9.48							9.59	
	Max	#22D	M	L & C	10.58							10.69	
	Min	#22D	F	L & C	9.15							9.26	
	Max	#22D	F	L & C	10.58							10.69	
	Min	#22D	M	S	9.65							9.76	
	Max	#22D	M	S	10.75							10.86	
	Min	#22D	F	S	9.15							9.26	
	Max	#22D	F	S	10.75							10.86	
	Min	#20	M	C	9.65							9.76	
	Max	#20	M	C	10.75							10.86	
	Min	#20	F	C	9.65							9.76	
	Max	#20	F	C	10.75							10.86	
	Min	#16	M	C	9.65							9.76	
	Max	#16	M	C	10.75							10.86	
	Min	#16	F	C	9.65							9.76	
	Max	#16	F	C	10.75							10.86	

M: Male contact

F: Female contact

L: Long PC tail

C: Short PC tail

S: Specific PC tail

Dimensions in millimeters

8D - D38999 Aluminum Series



Souriau backshells part numbers

Basic Series									8D	102	B	02
Shell style:												
09	11	13	15	17	19	21	23	25				
101	102	103	104	105	106	107	108	109				
Plating:												
B: Olive drab cadmium												
F: Nickel												
Backshell type:												
01: Back nut (please consult us)												
02: Straight cable clamp												
03: 90° cable clamp												
13: Backshell for heat shrink boots												

Cross reference table

Backshell type	AS85049 Standard	Souriau Part Numbers
Back nut	M85049/14-**-x	8D101x01
Straight cable clamp	M85049/38-**-x	8D101x02
90° cable clamp	M85049/39-**-x	8D101x03
Backshell for heat shrink boots	M85049/69-**-x	8D101x13
Backshell for screen termination and cable clamp	M85049/19-**-x	N/A

x: Plating **: Shell size: see pages 11 to 14

8D - D38999 Aluminum Series



Backshells - Cable clamp

Straight cable clamp (Type 38)

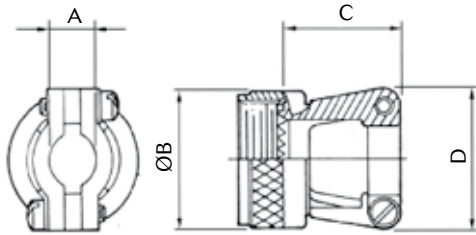

90° cable clamp (Type 39)

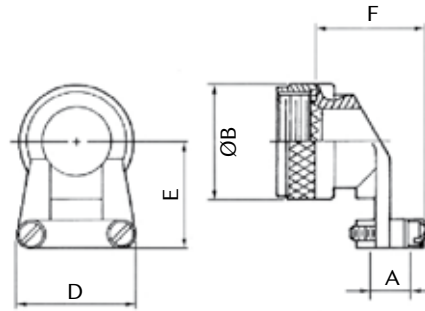

Shell size	A		ØB Max	C Max	D Max	E	F
	Min	Max					
09	2.50	5.90	21.80	23.10	21.60	25.40	25.70
11	3.90	5.90	25.00	23.10	22.90	27.90	25.70
13	4.80	8.30	29.40	25.70	27.90	27.90	30.70
15	6.60	11.60	32.50	26.90	29.20	31.80	32.00
17	7.20	15.60	35.70	29.50	33.00	33.00	35.80
19	8.30	16.10	38.50	35.80	38.10	34.30	38.40
21	8.70	17.70	41.70	38.40	40.60	40.60	42.20
23	9.70	20.90	44.90	42.20	43.20	44.50	44.70
25	10.60	21.70	48.00	44.70	45.70	47.00	48.50

Basic Series M85049 38 - 11 W

Backshell type:

- 38: Straight cable clamp
- 39: 90° cable clamp

Nut type:

- : Without self-locking
- S: With self-locking

Shell size:

09, 11, 13, 15, 17, 19, 21, 23, 25

Plating:

Type 38 & 39:

- A: Black anodized (500 hours salt spray)
- W: Olive drab cadmium over nickel (500 hours salt spray)

Type 38S & 39S:

- W: Olive drab cadmium over nickel (500 hours salt spray)
- N: Nickel (48 hours salt spray)

Note: All dimensions are in millimeters (mm)

8D - D38999 Aluminum Series



Backshell for screen termination and cable clamp

Backshell for screen termination and cable clamp (Type 19)

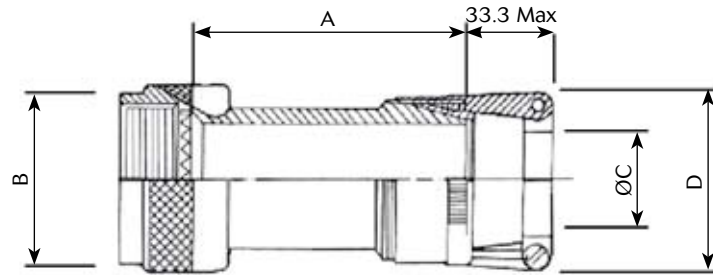

Shell size	A Max	B Max	Clamp indicator base on shell size
09	38.10	19.10	01 - 02
11		21.60	01 - 02 - 03
13		25.40	02 - 03 - 04
15		27.90	02 - 03 - 04 - 05
17		31.80	02 - 03 - 04 - 05 - 06
19		35.60	03 - 04 - 05 - 06 - 07
21		38.10	03 - 04 - 05 - 06 - 07 - 08
23		41.90	03 - 04 - 05 - 06 - 07 - 08
25		44.50	04 - 05 - 06 - 07 - 08 - 10

Clamp size indicator	C		D
	Min	Max	
01	1.60	3.20	20.30
02	3.20	6.35	25.40
03	6.35	9.50	27.90
04	7.90	12.70	30.50
05	11.10	15.90	31.80
06	14.30	19.00	35.60
07	17.45	22.20	38.10
08	20.60	24.40	41.90
09	23.80	28.60	44.50
10	27.00	31.75	48.30

Basic Series M85049 19 11 W 03

Shell style:
19: Backshell for screen termination and cable clamp

Shell size:
09, 11, 13, 15, 17, 19, 21, 23, 25

Plating:
W: Olive drab cadmium
N: Nickel

Clamp size indicator:
See tables above

Note: All dimensions are in millimeters (mm)

8D - D38999 Aluminum Series



Backshells for heat shrink boots

Backshell for heat shrink boots (Type 69)

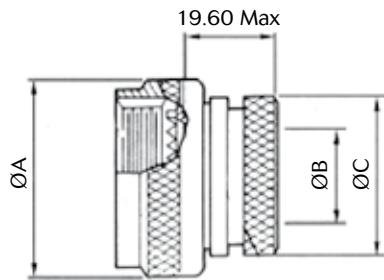

Shell size	ØA Max	ØB Max	ØC Max
09	19.10	6.35	13.55
11	21.60	9.50	15.40
13	25.40	12.70	19.70
15	29.20	15.90	21.30
17	31.80	19.00	24.50
19	35.60	20.60	26.50
21	39.40	23.80	30.90
23	41.90	27.00	34.40
25	47.00	30.20	36.65

Straight backshell for heat shrink boots (Type 88)

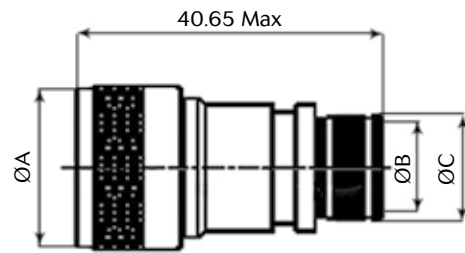

Shell size	ØA Max	ØB ^{±0.10} Entry size		ØC	
		02	03	02	03
09	21.79	N/A	6.35	N/A	10.03
11	24.99	N/A	7.92	N/A	11.61
13	29.39	7.92	11.13	11.61	14.81
15	32.49	11.13	14.27	14.81	17.96
17	35.71	12.70	15.88	16.38	19.56
19	38.51	15.88	19.05	19.56	22.73
21	41.71	15.88	20.62	19.56	24.30
23	44.91	17.47	23.83	21.06	27.51
25	47.98	19.05	25.40	22.73	29.08

Basic Series

M85049

69

11

A

D

Backshell type:

69: Backshell for heat shrink boots

88: Straight backshell for heat shrink boots

Shell size:

09, 11, 13, 15, 17, 19, 21, 23, 25

Plating:

Type 69:

A: Black anodised (500 hours salt spray)

Type 88:

J: Olive drab cadmium over electroless nickel

M: Electroless nickel

Option (Type 69 only):

Empty: Without drain hole

D: With drain hole

Entry size (Type 88 only):

02: See table above

03: See table above

8D - D38999 Aluminum Series



Dummy receptacle

Dimensions

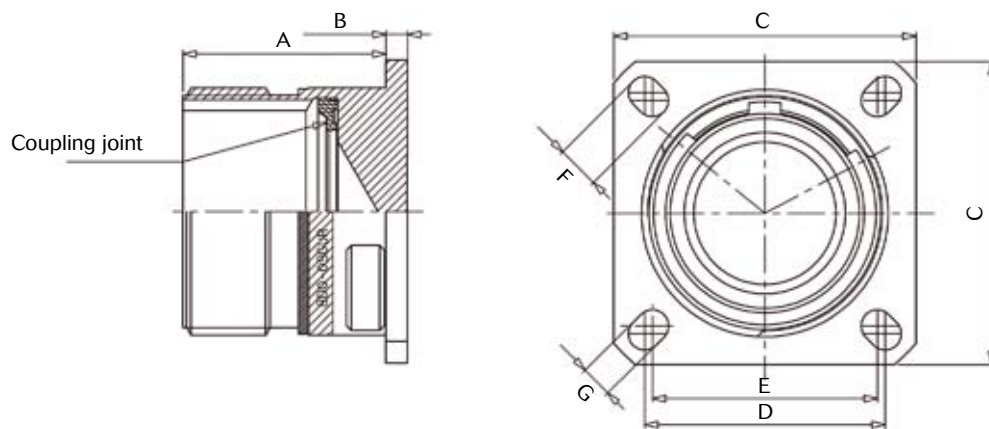

Shell size	Souriau Part number *	A Max	B Max	C ± 0.30	D	E	F ± 0.20	G ± 0.20
09	8D0-09GUR 8D0-09FUR	20.90	2.50	23.80	18.26	15.09	4.49	3.25
11	8D0-11GUR 8D0-11FUR	20.90	2.50	26.20	20.62	18.26	4.93	3.25
13	8D0-13GUR 8D0-13FUR	20.90	2.50	28.60	23.01	20.62	4.93	3.25
15	8D0-15GUR 8D0-15FUR	20.90	2.50	31.00	24.61	23.01	4.93	3.25
17	8D0-17GUR 8D0-17FUR	20.90	2.50	33.30	26.97	24.61	4.93	3.25
19	8D0-19GUR 8D0-19FUR	20.90	2.50	36.50	26.97	24.61	4.93	3.25
21	8D0-21GUR 8D0-21FUR	20.10	3.20	39.70	31.75	29.36	4.93	3.25
23	8D0-23GUR 8D0-23FUR	20.10	3.20	42.90	34.93	31.75	6.15	3.91
25	8D0-25GUR 8D0-25FUR	20.10	3.20	46.00	38.10	34.93	6.15	3.91

* G: Olive green cadmium
F: Nickel

Note: All dimensions are in millimeters (mm)

8D - D38999 Aluminum Series



Caps

Caps for receptacle (D38999/33 - S2453)

With rope and eyelet

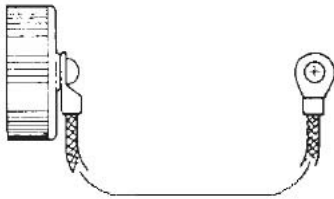

With rope and ring

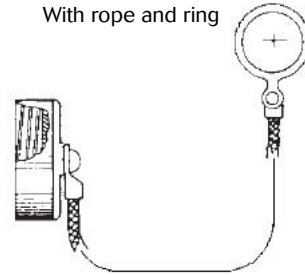

Shell size	Part numbers	
	Plating **	Olive green plating
9	S2453-09W-**	D38999/33 W 09 R
11	S2453-11W-**	D38999/33 W 11 R
13	S2453-13W-**	D38999/33 W 13 R
15	S2453-15W-**	D38999/33 W 15 R
17	S2453-17W-**	D38999/33 W 17 R
19	S2453-19W-**	D38999/33 W 19 R
21	S2453-21W-**	D38999/33 W 21 R
23	S2453-23W-**	D38999/33 W 23 R
25	S2453-25W-**	D38999/33 W 25 R

Shell size	Part numbers	
	Plating **	Olive green plating
9	S2453-09W**-1	D38999/33 W 09 N
11	S2453-11W**-1	D38999/33 W 11 N
13	S2453-13W**-1	D38999/33 W 13 N
15	S2453-15W**-1	D38999/33 W 15 N
17	S2453-17W**-1	D38999/33 W 17 N
19	S2453-19W**-1	D38999/33 W 19 N
21	S2453-21W**-1	D38999/33 W 21 N
23	S2453-23W**-1	D38999/33 W 23 N
25	S2453-25W**-1	D38999/33 W 25 N

Caps for plug (D38999/32 - S2454)

With rope and eyelet

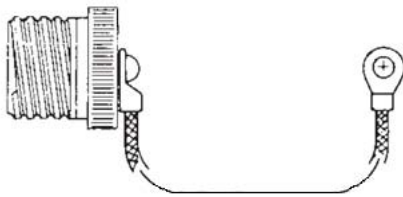

With rope and ring

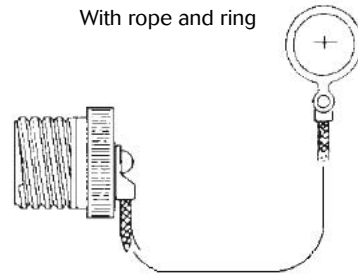

Shell size	Part numbers	
	Plating **	Olive green plating
9	S2454-09F-** S	D38999/32 W 09 R
11	S2454-11F-** S	D38999/32 W 11 R
13	S2454-13F-** S	D38999/32 W 13 R
15	S2454-15F-** S	D38999/32 W 15 R
17	S2454-17F-** S	D38999/32 W 17 R
19	S2454-19F-** S	D38999/32 W 19 R
21	S2454-21F-** S	D38999/32 W 21 R
23	S2454-23F-** S	D38999/32 W 23 R
25	S2454-25F-** S	D38999/32 W 25 R

Shell size	Part numbers	
	Plating **	Olive green plating
9	S2454-09W**-S	D38999/32 W 09 N
11	S2454-11W**-S	D38999/32 W 11 N
13	S2454-13W**-S	D38999/32 W 13 N
15	S2454-15W**-S	D38999/32 W 15 N
17	S2454-17W**-S	D38999/32 W 17 N
19	S2454-19W**-S	D38999/32 W 19 N
21	S2454-21W**-S	D38999/32 W 21 N
23	S2454-23W**-S	D38999/32 W 23 N
25	S2454-25W**-S	D38999/32 W 25 N

** Plating - 34 : Olive green cadmium. Plating - 12 : Nickel.

Note: Method of attachment to cover and ring is optional. Please consult us.

8D - D38999 Aluminum Series



Connectors weight

	With contacts						Without contact					
	Plug (type 5)		Receptacle (type 0)		Receptacle (type 7)		Plug (type 5)		Receptacle (type 0)		Receptacle (type 7)	
	Male	Female	Male	Female	Male	Female	Male	Female	Male	Female	Male	Female
09 – 35	11.47	13.05	9.15	10.73	13.91	15.49	11.05	11.55	8.73	9.23	13.49	13.99
09 – 98	11.47	12.77	9.15	10.45	13.91	15.21	11.05	11.57	8.73	9.25	13.49	14.01
11 – 01	14.98	17.92	12.01	14.95	18.17	21.11	14.32	16.32	11.35	13.35	17.51	19.51
11 – 02	14.61	17.15	11.64	14.18	17.80	20.34	13.99	15.59	11.02	12.62	17.18	18.78
11 – 04	14.80	17.86	11.83	14.89	17.99	21.05	14.24	16.26	11.27	13.29	17.43	19.45
11 – 05	14.83	18.04	11.86	15.07	19.48	21.23	14.13	16.04	11.16	13.07	17.32	19.23
11 – 22	14.47	16.89	11.50	13.92	17.66	20.08	14.19	15.89	11.22	12.92	17.38	19.08
11 – 35	14.73	18.20	11.76	15.23	17.68	21.39	13.82	14.95	10.85	11.98	17.01	18.14
11 – 80	18.30	21.90	15.30	18.90	21.50	28.39	13.80	14.90	10.80	11.90	17.00	18.10
11 – 98	14.70	17.46	11.73	14.49	17.89	20.65	13.86	15.06	10.89	12.09	17.05	18.25
11 – 99	14.87	18.09	11.90	15.12	18.06	21.28	13.89	15.29	10.92	12.32	17.08	18.48
13 – 04	21.04	24.82	15.71	19.49	24.14	27.92	19.80	21.70	14.47	16.37	22.90	24.80
13 – 08	21.42	26.60	16.09	21.27	24.52	29.70	20.30	23.40	14.97	18.07	23.40	26.50
13 – 26	21.79	27.44	16.46	22.11	24.89	30.54	20.05	22.74	14.72	17.41	23.15	25.84
13 – 35	21.22	26.99	15.89	21.66	24.32	30.09	19.68	21.49	14.35	16.16	22.78	24.59
13 – 98	21.08	25.70	15.75	20.37	24.18	28.80	19.68	21.70	14.35	16.37	22.78	24.80
15 – 05	26.04	31.38	19.54	24.88	29.62	34.96	24.49	27.48	17.99	20.98	28.07	31.06
15 – 15	26.84	34.00	20.34	27.50	30.42	37.58	24.57	27.62	18.07	21.12	28.15	31.20
15 – 18	27.05	35.93	20.55	29.43	30.63	39.51	24.53	28.73	18.03	22.23	28.11	32.31
15 – 19	26.58	34.31	20.08	27.81	30.16	37.89	23.92	26.71	17.42	20.21	27.50	30.29
15 – 35	26.68	35.92	20.18	29.42	30.26	39.50	24.09	26.67	17.59	20.17	27.67	30.25
15 – 97	26.51	33.56	20.01	27.06	30.09	37.14	24.15	27.24	17.65	20.74	27.73	30.82
17 – 02	32.96	46.30	31.26	44.60	42.06	55.40	25.80	29.80	24.10	28.10	34.90	38.90
17 – 06	29.90	39.50	28.21	37.81	39.00	48.60	25.94	29.90	24.25	28.21	35.04	39.00
17 – 08	28.89	37.62	27.20	35.93	37.99	46.72	26.41	31.38	24.72	29.69	35.51	40.48
17 – 26	29.47	40.26	27.78	38.57	38.57	49.36	25.83	29.86	24.14	28.17	34.93	38.96
17 – 35	29.71	43.26	28.02	41.57	38.81	52.36	25.86	29.51	24.17	27.82	34.96	38.61
17 – 75	35.31	46.60	33.62	44.91	44.41	55.70	26.31	32.60	24.62	30.91	35.41	41.70
17 – 99	29.52	40.08	27.83	38.39	38.62	49.18	25.96	30.12	24.27	28.43	35.06	39.22
19 – 11	37.77	51.36	31.07	44.66	44.62	58.21	34.36	42.78	27.66	46.43	30.86	49.63
19 – 32	36.98	50.38	30.28	43.68	43.83	57.23	32.50	37.58	25.80	41.23	29.00	44.43
19 – 35	37.29	53.74	30.59	47.04	44.14	44.09	32.67	37.24	25.97	40.89	29.17	44.09
21 – 11	45.51	65.35	39.31	59.15	53.19	73.03	38.25	47.75	32.05	51.93	35.55	55.43
21 – 16	42.61	57.89	36.41	51.69	50.29	65.57	37.65	45.41	31.45	49.59	34.95	53.09
21 – 35	42.89	63.55	36.69	57.35	50.57	71.23	37.36	43.80	31.16	47.98	34.66	51.48
21 – 39	44.27	64.60	38.07	58.40	51.95	72.28	38.47	48.24	32.27	52.42	35.77	55.92
21 – 41	42.81	60.18	36.61	64.36	50.49	67.86	37.07	43.78	30.87	47.96	34.37	51.46
21 – 48	49.59	49.93	43.39	43.73	55.27	57.61	36.48	43.38	30.28	37.18	44.16	51.06
21 – 75	54.48	71.38	48.28	65.18	62.16	79.06	36.48	43.38	30.28	37.18	44.16	51.06
23 – 21	50.49	73.74	44.19	67.44	59.23	82.48	43.98	57.36	37.68	62.20	41.58	66.10
23 – 35	48.85	75.00	42.55	68.70	57.59	83.74	41.85	50.00	35.55	54.84	39.45	58.74
23 – 53	48.91	71.10	42.61	64.80	57.65	79.84	41.49	49.90	35.19	54.74	39.09	58.64
23 – 55	49.66	72.73	43.36	66.43	58.40	81.47	41.96	50.73	35.66	55.57	39.56	59.47
25 – 07	61.89	90.70	55.73	85.10	71.15	99.10	46.41	56.20	40.25	61.26	44.45	65.46
25 – 11	54.48	71.38	48.28	65.18	62.16	79.06	36.48	43.38	42.94	55.94	58.36	71.36
25 – 19	59.76	91.77	53.60	85.61	69.02	101.03	47.22	61.37	41.06	66.43	45.26	70.63
25 – 24	59.26	90.62	53.10	84.46	68.52	99.88	47.62	62.06	41.46	67.12	45.66	71.32
25 – 29	57.58	86.55	51.42	80.39	66.84	95.81	48.59	63.93	42.43	68.99	46.63	73.19
25 – 35	55.37	88.20	49.21	82.04	64.63	97.46	46.41	56.20	40.25	61.26	44.45	65.46
25 – 37	57.57	89.86	51.41	59.36	66.83	90.06	46.10	61.00	39.94	60.50	55.36	61.20
25 – 44	52.80	67.61	46.53	65.39	62.05	83.39	44.40	59.22	38.14	57.00	53.66	75.00
25 – 43	57.62	88.30	51.46	82.14	66.88	97.56	48.20	63.50	42.04	68.56	46.24	72.76
25 – 46	59.92	83.76	53.76	77.60	69.18	93.02	45.28	55.44	39.12	60.50	43.32	64.70
25 – 61	54.67	81.42	48.51	75.26	63.93	90.68	46.13	57.02	39.97	62.08	44.17	66.28
25 – 08	81.00	112.83	74.84	106.67	90.26	122.09	45.00	56.83	38.84	61.69	43.04	66.09
25 – 20	66.02	96.24	59.86	90.08	75.28	105.50	44.45	54.70	38.29	59.76	42.49	63.96
25 – 04	58.42	88.27	52.26	82.11	67.68	97.53	49.22	62.83	43.06	67.89	47.26	72.09

Weight in gram (+/- 15%)



Composite Series

MIL-DTL-38999 Series III

8D - D38999 Composite Series



Connector part numbers

Basic Series	8D	0	-	11	J	35	P	N	-	-	L
Shell style:											
0: Square flange receptacle											
5: Plug with RFI shielding											
Type:											
None: Connectors with standard crimp contacts.											
L: Receptacle with long PC tail (male and female size #22D, #20).											
C: Receptacle with short PC tail (male and female #22D, #20, #16).											
S: Receptacle with specific PC tail (male et female #22D)											
W: Receptacle with male contacts #22D for wire wrap (3 wraps)											
T: Receptacle with male contacts #20 for wire wrap (2 wraps)											
P: Receptacle with solder cup (male and female size #22D; male #16 & #12; female #16 & #12 and male female #20 please consult us)											
Shell size: 09, 11, 13, 15, 17, 19, 21, 23, 25											
Plating:											
J: Olive drab cadmium											
M: Nickel											
X: Without plating											
Contact layout: See pages 11 to 14											
Contact type:											
P: Pin (500 mating/unmating)											
H: Pin (1500 mating/unmating)											
A: Connector supplied less pin contact or with specific contacts (connector marking: A + orientation)											
S: Socket (500 mating/unmating)											
J: Socket (1500 mating/unmating)											
B: Connector supplied less socket contact or with specific contacts (connector marking: B + orientation)											
Orientation: N, A, B, C, D, E (see page 65)											
Specification:											
046: Tinned straight PC tail											
251: Connector provided with power contacts (layouts with contact #8)											
022: Fuel tank											
Special custom:											
None: Standard plastic cap											
M: Antistatic plastic cap											
L: For P or S contact type only, connectors delivered without contacts, connectors marking P or S plus orientation.											

MIL-DTL-38999 part numbers*

Basic Series	D38999	20	M	B	35	P	N	L
Shell style:								
20: Square flange receptacle								
26: Plug with RFI shielding.								
Plating:								
J: Olive drab cadmium								
M: Nickel								
Shell size: 09=A, 11=B, 13=C, 15=D, 17=E, 19=F, 21=G, 23=H, 25=J								
Contact layout: See page 15 for layout according to MIL-DTL-38999								
Contact type:								
P: Pin (500 mating/unmating)								
H: Pin (1500 mating/unmating)								
A: Connector supplied less pin contact or with specific contacts (connector marking: A + orientation)								
S: Socket (500 mating/unmating)								
J: Socket (1500 mating/unmating)								
B: Connector supplied less socket contact or with specific contacts (connector marking: B + orientation)								
Orientation: N, A, B, C, D, E (see page 65)								
L: For P or S contact type only, connector delivered without contacts, connector marking P or S (without L)								

* Note: To place an order of MIL connectors delivered without MIL removable crimp contacts and keep P or S plus orientation marking, it must be specify clearly on the order (by adding a suffix L at the end of the P/N or specified in comment).

8D - D38999 Composite Series



BACC part numbers

Basic Series: BACC63CT: 8D5*M (composite plug) BACC63CU: 8D0*M (composite square flange receptacle)	BACC63CT	13	98	P	N	H
Shell size: 09=A, 11=B, 13=C, 15=D, 17=E, 19=F, 21=G, 23=H, 25=J						
Contact layout: See page 15 for layout according to BACC						
Contact type: P: Pin A: Connector supplied less pin contact or with specific contacts (connector marking: A + orientation) S: Socket B: Connector supplied less socket contact or with specific contacts (connector marking: B + orientation)						
Orientation: N, A, B, C, D, E (see page 65)						
H: Without contacts & without filler plug = L -: Empty with contacts						

EN3645 part numbers

Basic Series	EN3645	J	6	G	N	35	B	N
Plating: J: Olive drab cadmium M: Nickel								
Shell style: 0: Square flange receptacle 6: Plug								
Shell size: 09=A, 11=B, 13=C, 15=D, 17=E, 19=F, 21=G, 23=H, 25=J								
Grounding: N: Standard insert not grounded								
Contact layout: See page 15 for layout according to EN3645								
Contact type: A: Connector supplied less pin contact B: Connector supplied less socket contact F: Socket M: Pin								
Orientation: N, A, B, C, D, E (see page 65)								

8D - D38999 Composite Series



Dimensions

Receptacle type 0										
	Shell size	A Max	B Max	C Max	D Thread	E ^{±0.3}	F	G	H ^{±0.2}	J ^{±0.2}
	09 (A)	19.65	11.96	3.65	M12 x 1-6g	23.8	18.26	15.09	3.25	5.49
11 (B)	M15 x 1-6g				26.2	20.62	18.26	4.93		
13 (C)	M18 x 1-6g				28.6	23.01	20.62	4.39		
15 (D)	M22 x 1-6g				31	24.61	23.01			
17 (E)	M25 x 1-6g				33.3	26.97	24.61			
19 (F)	3.7	M28 x 1-6g	36.5	29.36	26.97	4.93				
21 (G)	18.85	12.76	4.35	M31 x 1-6g	39.7	31.75	29.36	3.91	6.15	
23 (H)				4.4	M34 x 1-6g	42.9	34.93			31.75
25 (J)					M37 x 1-6g	46	38.1			34.93

Plug type 5				
	Shell size	A Max.	B thread	C Max.
	09 (A)	31.00	M12 x 1-6g	21.80
11 (B)	31.00	M15 x 1-6g	25.00	
13 (C)	31.00	M18 x 1-6g	29.40	
15 (D)	31.00	M22 x 1-6g	32.50	
17 (E)	31.00	M25 x 1-6g	35.70	
19 (F)	31.00	M28 x 1-6g	38.50	
21 (G)	31.00	M31 x 1-6g	41.70	
23 (H)	31.00	M34 x 1-6g	44.90	
25 (J)	31.00	M37 x 1-6g	48.00	

Mated connectors			
	Shell size	A Max.	B Max.
	09 (A)	37.00	52.30
11 (B)	37.00	52.30	
13 (C)	37.00	52.30	
15 (D)	37.00	52.30	
17 (E)	37.00	52.30	
19 (F)	37.00	52.30	
21 (G)	36.00	51.30	
23 (H)	36.00	51.30	
25 (J)	36.00	51.30	

Note: All dimensions are in millimeters (mm)

8D - D38999 Composite Series



Receptacle with straight PC tail contacts

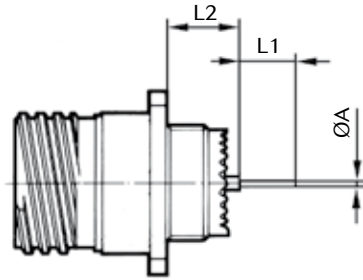

	Shell size			09 (A)	11 (B)	13 (C)	15 (C)	17 (E)	19 (F)	21 (G)	23 (H)	25 (J)
	Contact size	Contact type	PC tail type									
A	#22D	M & F	L & C	0.70								
	#22D	M & F	S	0.50								
	#20	M & F	C	0.70								
	#16	M & F	C	1.15								
L1	#22D	M & F	L	8.50								
	#22D	M & F	C	4.00								
	#22D	M & F	S	5.00								
	#20	M & F	C	5.00								
	#16	M & F	C	5.00								
L2	Min	#22D	M	L & C	9.48				9.59			
	Max	#22D	M	L & C	10.38				10.48			
	Min	#22D	F	L & C	9.15				9.26			
	Max	#22D	F	L & C	10.58				10.69			
	Min	#22D	M	S	9.65				9.76			
	Max	#22D	M	S	10.55				10.65			
	Min	#22D	F	S	9.65				9.76			
	Max	#22D	F	S	10.55				10.65			
	Min	#20	M	C	9.65				9.76			
	Max	#20	M	C	10.55				10.65			
	Min	#20	F	C	9.65				9.76			
	Max	#20	F	C	10.55				10.65			
	Min	#16	M	C	9.65				9.76			
	Max	#16	M	C	10.55				10.65			
	Min	#16	F	C	9.65				9.76			
	Max	#16	F	C	10.55				10.65			

M: Male contact F: Female contact L: Long PC tail C: Short PC tail S: Specific PC tail

Note: All dimensions are in millimeters (mm)

8D - D38999 Composite Series



Backshells

Straight cable clamp (Type 91)

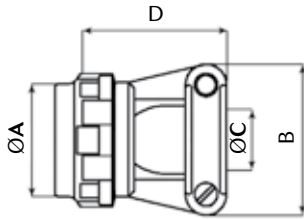

90° cable clamp (Type 92)

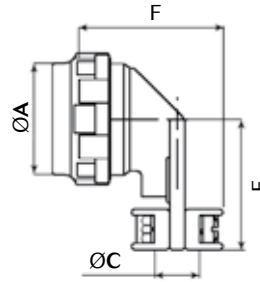

Shell size	ØA Max	B Max	C Max	D Max	E	F
09	21.80	24.90	5.55	21.25	22.20	26.95
11	25.00	26.00	6.70	24.30	23.80	27.95
13	29.40	30.50	8.75	27.95	26.20	30.00
15	32.50	33.00	11.70	27.95	28.60	33.00
17	35.70	36.10	13.85	31.25	33.30	35.05
19	38.50	38.60	15.60	35.80	34.95	36.85
21	41.70	41.65	17.75	38.35	38.10	39.15
23	44.90	45.00	19.80	42.15	41.30	41.15
25	48.00	48.00	21.60	44.70	44.45	42.95

Basic Series

M85049

91

11

M

Backshell type:

91: Straight cable clamp

92: 90° cable clamp

Shell size:

09, 11, 13, 15, 17, 19, 21, 23, 25

Plating:

J: Olive drab cadmium over electroless nickel

M: Electroless nickel

T: Without plating

8D - D38999 Composite Series



Connectors weight

	With contacts				Without contact			
	Plug (type 5)		Receptacle (type 0)		Plug (type 5)		Receptacle (type 0)	
	Male	Female	Male	Female	Male	Female	Male	Female
09-35	8.5	10.1	7.8	9.4	8.1	8.6	7.4	7.9
09-98	8.5	9.8	7.8	9.1	8.1	8.6	7.4	7.9
11-01	12.8	15.7	10.4	13.3	12.1	14.1	9.7	11.7
11-02	11.5	14.1	09.3	11.8	10.9	12.5	08.7	10.3
11-04	12.6	15.7	10.2	13.3	12.0	14.1	9.7	11.7
11-05	12.6	15.8	10.2	13.4	11.9	13.8	9.5	11.5
11-22	11.4	13.8	09.1	11.6	11.1	12.8	08.8	10.6
11-35	12.5	16.0	10.1	13.6	11.6	12.8	9.2	10.4
11-80	15.25	18.6	13.40	10.4	10.75	11.63	08.90	09.4
11-98	12.5	15.3	10.1	12.9	11.7	12.8	9.3	10.5
11-99	11.8	15.0	09.6	12.8	10.8	12.2	08.6	10.0
13-04	17.2	20.9	13.7	17.5	15.6	17.9	12.4	14.3
13-08	17.6	22.8	14.1	19.2	16.5	19.6	12.9	16.1
13-26	17.9	23.6	14.4	20.1	16.2	18.9	12.7	15.4
13-35	17.4	23.1	13.8	19.6	15.8	17.6	12.3	14.1
13-98	17.2	21.8	13.7	18.3	15.8	17.9	12.3	14.3
15-05	21.4	26.7	16.6	21.9	19.8	22.8	15.0	18.0
15-15	22.2	29.3	17.4	24.5	19.9	23.0	15.1	18.1
15-18	22.4	31.3	17.6	26.5	19.9	24.0	15.0	19.2
15-19	22.0	29.6	17.1	24.8	19.2	22.0	14.5	17.2
15-35	22.0	31.3	17.2	26.5	19.4	22.0	14.6	17.2
15-97	21.8	28.9	17.1	24.1	19.4	22.6	14.7	17.8
17-02	26.51	38.85	25.23	37.57	19.35	22.35	18.07	21.07
17-06	25.9	35.5	23.2	32.8	21.9	25.9	19.2	23.2
17-08	24.9	33.6	22.2	30.1	22.4	27.4	19.7	24.7
17-26	25.5	36.3	22.8	33.6	21.8	25.9	19.2	23.1
17-35	25.7	39.3	23.0	36.6	21.9	25.5	19.2	22.8
17-75	31.3	42.6	28.6	39.9	22.3	28.6	19.6	25.9
17-99	25.5	36.1	22.8	33.4	22.0	26.1	19.3	23.4
19-11	32.1	45.7	26.1	39.7	28.7	37.1	22.7	31.1
19-32	31.3	44.7	25.3	38.7	26.8	31.9	20.8	25.9
19-35	31.6	48.1	25.6	42.0	27.1	31.6	21.0	25.6
21-11	38.0	57.9	32.8	52.6	30.8	40.3	25.5	35.1
21-16	35.1	50.4	29.9	45.2	30.2	37.9	24.9	32.7
21-35	35.4	56.1	30.1	50.8	29.9	36.3	24.6	31.1
21-39	36.8	57.1	31.5	51.9	31.0	40.8	25.7	35.5
21-41	35.3	52.7	30.1	47.5	29.6	36.3	24.3	31.0
21-48	42.41	62.40	37.71	57.70	29.3	36.2	24.6	31.5
21-75	47.3	64.2	42.6	59.50	29.3	36.2	24.6	31.5
23-21	43.1	66.3	38.0	61.2	36.5	49.9	31.5	44.8
23-35	41.4	67.5	36.3	62.5	34.4	42.5	29.3	37.5
23-53	41.5	63.6	36.4	58.6	34.1	42.4	29.0	37.4
23-55	42.2	65.3	42.2	60.2	34.5	43.3	29.4	38.2
25-07	53.6	90.05	49.0	84.85	37.8	51.8	33.2	46.6
25-11	59.08	81.60	54.48	77.00	40.8	53.8	36.2	49.2
25-19	51.7	83.7	46.6	78.6	39.2	53.3	34.0	48.2
25-24	51.2	82.5	46.1	77.4	39.6	54.0	34.4	48.9
25-29	49.5	78.5	44.4	73.4	40.5	55.9	35.4	50.7
25-35	47.3	80.1	42.2	75.0	38.4	48.1	33.2	43.0
25-37	49.27	80.36	45.47	76.16	37.8	51.50	34.0	47.30
25-44	69.64	93.70	65.04	94.65	36.1	45.80	31.5	46.75
25-43	49.6	80.2	44.4	75.1	40.1	55.4	35.0	50.3
25-46	51.9	75.7	46.7	70.1	37.2	47.4	32.1	42.2
25-61	46.6	73.4	41.5	68.2	38.1	48.9	32.9	43.8
25-08	72.9	104.8	67.8	99.6	36.9	48.8	31.8	43.6
25-20	57.9	88.2	52.8	83.0	36.4	46.6	31.3	41.5
25-04	50.4	80.2	45.3	75.0	41.2	54.8	36.1	49.6

Weight in gram (+/- 15%)



Stainless Steel Series

MIL-DTL-38999 Series III

8D - D38999 Stainless Steel Series



Connector part numbers

Basic Series	8D	0	-	11	K	35	P	N	-	-	L
Shell style:											
0: Square flange receptacle											
7: Jam nut receptacle											
5: Plug with RFI shielding											
Type:											
None: Connectors with standard crimp contacts.											
L: Receptacle with long PC tail (male and female size #22D, #20).											
C: Receptacle with short PC tail (male and female #22D, #20, #16).											
S: Receptacle with specific PC tail (male et female #22D)											
W: Receptacle with male contacts #22D for wire wrap (3 wraps)											
T: Receptacle with male contacts #20 for wire wrap (2 wraps)											
P: Receptacle with solder cup (male and female size #22D; male #16 & #12; female #16 & #12 and male female #20 please consult us)											
Shell size: 09, 11, 13, 15, 17, 19, 21, 23, 25											
Plating:											
K: Passivated											
S: Nickel											
Contact layout: See pages 11 to 14											
Contact type:											
P: Pin											
A: Connector supplied less pin contact or with specific contacts (connector marking: A + orientation)											
S: Socket											
B: Connector supplied less socket contact or with specific contacts (connector marking: B + orientation)											
Orientation: N, A, B, C, D, E (see page 65)											
Specification:											
046: Tinned straight PC tail											
251: Connector provided with power contacts (layouts with contact #8)											
022: Fuel tank											
Special custom											
None: Standard plastic cap											
M: Antistatic plastic cap											
L: For P or S contact type only, connectors delivered without contacts, connectors marking P or S plus orientation.											

MIL-DTL-38999 part numbers*

Basic Series	D38999	20	K	B	35	P	N	L
Shell style:								
20: Square flange receptacle								
24: Jam nut receptacle								
26: Plug with RFI shielding.								
Plating:								
K: Passivated								
S: Nickel								
Shell size: 09=A, 11=B, 13=C, 15=D, 17=E, 19=F, 21=G, 23=H, 25=J								
Contact layout: See page 15 for layout according to MIL-DTL-38999								
Contact type:								
P: Pin								
A: Connector supplied less pin contact or with specific contacts (connector marking: A + orientation)								
S: Socket								
B: Connector supplied less socket contact or with specific contacts (connector marking: B + orientation)								
Orientation: N, A, B, C, D, E (see page 65)								
L: For P or S contact type only, connector delivered without contacts, connector marking P or S (without L)								

* Note: To place an order of MIL connectors delivered without MIL removable crimp contacts and keep P or S plus orientation marking, it must be specified clearly on the order (by adding a suffix L at the end of the P/N or specified in comment).

8D - D38999 Stainless Steel Series



BACC part numbers

Basic Series: BACC63DB: 8D5*K (stainless steel plug) BACC63DC: 8D0*K (stainless steel square flange receptacle)	BACC63DB	13	98	P	N	H
Shell size: 09=A, 11=B, 13=C, 15=D, 17=E, 19=F, 21=G, 23=H, 25=J						
Contact layout: See page 15 for layout according to BACC						
Contact type: P: Pin A: Connector supplied less pin contact or with specific contacts (connector marking: A + orientation) S: Socket B: Connector supplied less socket contact or with specific contacts (connector marking: B + orientation)						
Orientation: N, A, B, C, D, E (see page 65)						
H: Without contacts & without filler plug = L -: Empty with contacts						

EN3645 part numbers

Basic Series	EN3645	K	6	G	N	35	B	N
Plating: K: Stainless steel passivated								
Shell style: 0: Square flange receptacle 6: Plug 7: Jam nut receptacle								
Shell size: 09=A, 11=B, 13=C, 15=D, 17=E, 19=F, 21=G, 23=H, 25=J								
Grounding: N: Standard insert not grounded								
Contact layout: See page 15 for layout according to EN3645								
Contact type: A: Connector supplied less pin contact B: Connector supplied less socket contact F: Socket M: Pin								
Orientation: N, A, B, C, D, E (see page 65)								

8D - D38999 Stainless Steel Series



Dimensions

Receptacle type 0 (8D) or type 20 (D38999)

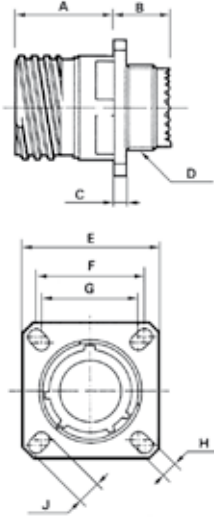

Shell size	A Max	B Max	C Max	D Thread	E ± 0.3	F	G	H ± 0.2	J ± 0.2
09 (A)	20.2	11.4	2.5	M12 x 1-6g	23.8	18.26	15.09	3.25	5.49
11 (B)				M15 x 1-6g	26.2	20.62	18.26		4.93
13 (C)				M18 x 1-6g	28.6	23.01	20.62		4.4
15 (D)				M22 x 1-6g	31	24.61	23.01		4.93
17 (E)				M25 x 1-6g	33.3	26.97	24.61		4.93
19 (F)				M28 x 1-6g	36.5	29.36	26.97		4.93
21 (G)	19.8	11.8	3.2	M31 x 1-6g	39.7	31.75	29.36	3.91	6.15
23 (H)		11.4		M34 x 1-6g	42.9	34.93	31.75		
25 (J)				M37 x 1-6g	46	38.1	34.93		

Receptacle type 7 (8D) or type 24 (D38999)

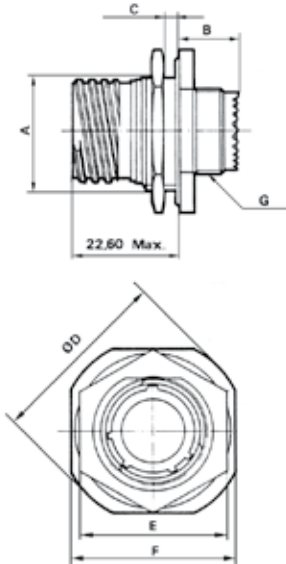

Shell size	A ± 0.15	B Max	C Max	D Max	E Max	F ± 0.4	G Thread
09 (A)	16.57	9.9	3.2	30.5	23	27	M12 x 1-6g
11 (B)	19.12			35.2	26	31.8	M15 x 1-6g
13 (C)	23.87			38.4	31	34.9	M18 x 1-6g
15 (D)	27.02			41.6	34	38.1	M22 x 1-6g
17 (E)	30.2			44.8	37	41.3	M25 x 1-6g
19 (F)	33.37			49.5	41	46	M28 x 1-6g
21 (G)	36.55			52.7	46	49.2	M31 x 1-6g
23 (H)	39.72			55.9	47	52.4	M34 x 1-6g
25 (J)	42.90			59	51.23	55.6	M37 x 1-6g

Recommended coupling torque on panel for jam nut receptacle (type 7)

Shell	09 (A)	11 (B)	13 (C)	15 (D)	17 (E)	19 (F)	21 (G)	23 (H)	25 (J)
Coupling torque (± 0.5 N.m)	4	5	7	8	9	10	12	13	14

Note: All dimensions are in millimeters (mm)

8D - D38999 Stainless Steel Series



Plug type 5 (8D) or type 26 (D38999)

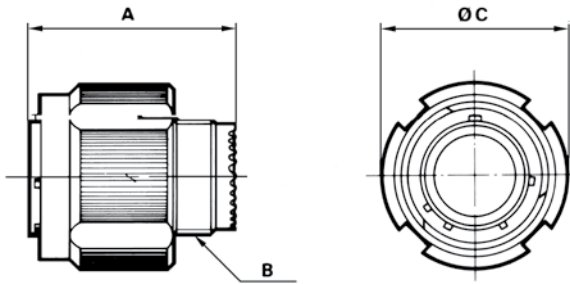

Shell size	A Max.	B thread	C Max.
09 (A)	31.00	M12 x 1-6g	21.80
11 (B)	31.00	M15 x 1-6g	25.00
13 (C)	31.00	M18 x 1-6g	29.40
15 (D)	31.00	M22 x 1-6g	32.50
17 (E)	31.00	M25 x 1-6g	35.70
19 (F)	31.00	M28 x 1-6g	38.50
21 (G)	31.00	M31 x 1-6g	41.70
23 (H)	31.00	M34 x 1-6g	44.90
25 (J)	31.00	M37 x 1-6g	48.00

Mated connectors dimensions

Type 0 with plug

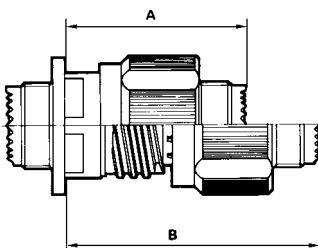

Type 7 with plug

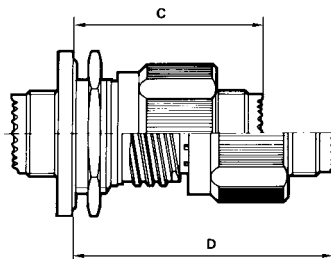

Shell size	A Max.	B Max.	C Max.	D Max.
09 (A)	37.00	52.30	38.30	53.60
11 (B)	37.00	52.30	38.30	53.60
13 (C)	37.00	52.30	38.50	53.80
15 (D)	37.00	52.30	38.50	53.80
17 (E)	37.00	52.30	38.50	53.80
19 (F)	37.00	52.30	38.50	53.80
21 (G)	36.00	51.30	38.50	53.80
23 (H)	36.00	51.30	38.50	53.80
25 (J)	36.00	51.30	38.50	53.80

Note: All dimensions are in millimeters (mm)

8D - D38999 Stainless Steel Series



Receptacle with straight PC tail contacts



		Shell size			09 (A)	11 (B)	13 (C)	15 (C)	17 (E)	19 (F)	21 (G)	23 (H)	25 (J)
		Contact size	Contact type	PC tail type									
A		#22D	M & F	L & C					0.70				
		#22D	M & F	S					0.50				
		#20	M & F	C					0.70				
		#16	M & F	C					1.15				
L1	Min	#22D	M	L & C	10.52					10.34			
	Max	#22D	M	L & C	11.46					11.28			
	Min	#22D	F	L & C	10.19					10.01			
	Max	#22D	F	L & C	11.46					11.28			
	Min	#22D	M	S	10.69					10.51			
	Max	#22D	M	S	11.63					11.45			
	Min	#22D	F	S	10.36					10.18			
	Max	#22D	F	S	11.63					11.45			
	Min	#20	M	C	10.69					10.51			
	Max	#20	M	C	11.63					11.45			
	Min	#20	F	C	10.69					10.51			
	Max	#20	F	C	11.63					11.45			
	Min	#16	M	C	10.69					10.51			
	Max	#16	M	C	11.63					11.45			
	Min	#16	F	C	10.69					10.51			
	Max	#16	F	C	11.63					11.45			
L2		#22D	M & F	L					8.50				
		#22D	M & F	C					4.00				
		#22D	M & F	S					5.10				
		#20	M & F	C					5.10				
		#16	M & F	C					5.10				
L3	Min	#22D	M	L & C			9.48					9.59	
	Max	#22D	M	L & C			10.58					10.69	
	Min	#22D	F	L & C			9.15					9.26	
	Max	#22D	F	L & C			10.58					10.69	
	Min	#22D	M	S			9.65					9.76	
	Max	#22D	M	S			10.75					10.86	
	Min	#22D	F	S			9.15					9.26	
	Max	#22D	F	S			10.75					10.86	
	Min	#20	M	C			9.65					9.76	
	Max	#20	M	C			10.75					10.86	
	Min	#20	F	C			9.65					9.76	
	Max	#20	F	C			10.75					10.86	
	Min	#16	M	C			9.65					9.76	
	Max	#16	M	C			10.75					10.86	
	Min	#16	F	C			9.65					9.76	
	Max	#16	F	C			10.75					10.86	

M: Male contact

F: Female contact

L: Long PC tail

C: Short PC tail

S: Specific PC tail

Dimensions in millimeters

8D - D38999 Stainless Steel Series



Connectors weight

	With contacts						Without contact					
	Plug (type 5)		Receptacle (type 0)		Receptacle (type 7)		Plug (type 5)		Receptacle (type 0)		Receptacle (type 7)	
	Male	Female	Male	Female	Male	Female	Male	Female	Male	Female	Male	Female
09-35	30.63	32.21	23.93	25.51	33.93	35.51	30.21	30.71	23.51	24.01	33.51	34.01
09-98	30.63	31.93	23.93	25.23	33.93	35.23	30.21	30.73	23.51	24.03	33.51	34.03
11-01	38.13	41.07	29.53	32.47	42.43	45.37	37.47	39.47	28.87	30.87	41.77	43.77
11-02	37.76	40.30	29.36	30.12	46.98	49.52	37.14	38.74	28.56	30.16	46.36	47.96
11-04	37.95	41.01	29.35	32.41	42.25	45.31	37.39	39.41	28.79	30.81	41.69	43.71
11-05	37.98	41.19	29.38	32.59	42.04	45.49	37.28	39.19	28.68	30.59	41.58	43.49
11-22	37.48	39.54	28.90	130.86	46.70	48.76	37.34	39.04	28.76	30.36	46.56	48.26
11-35	37.88	41.35	29.28	32.75	41.94	45.65	36.97	38.10	28.37	29.50	41.27	42.40
11-80	38.12	44.84	29.73	36.26	47.78	54.06	34.86	37.84	26.45	29.26	44.51	47.06
11-98	37.85	40.61	29.25	32.01	42.15	44.91	37.01	38.21	28.41	29.61	41.31	42.51
11-99	38.02	41.24	29.44	32.66	47.24	50.46	37.04	38.44	28.46	29.86	46.26	47.66
13-04	53.34	57.12	37.94	41.72	56.24	60.02	52.10	54.00	36.70	38.60	55.00	56.90
13-08	53.72	58.90	38.32	43.50	56.62	61.80	52.60	55.70	37.20	40.30	55.50	58.60
13-26	54.09	59.74	38.69	44.34	56.99	62.64	52.35	55.04	36.95	39.64	55.25	57.94
13-35	53.52	59.29	38.12	43.89	56.42	62.19	51.98	53.79	36.58	38.39	54.88	56.69
13-98	53.38	58.00	37.98	42.60	56.28	60.90	51.98	54.00	36.58	38.60	54.88	56.90
15-05	64.49	69.83	45.69	51.03	67.59	72.93	62.94	65.93	44.14	47.13	66.04	69.03
15-15	65.29	72.45	46.49	53.65	68.39	75.55	63.02	66.07	44.22	47.27	66.12	69.17
15-18	65.50	74.38	46.70	55.58	68.60	77.48	62.98	67.18	44.18	48.38	66.08	70.28
15-19	65.03	72.76	46.23	53.96	68.13	75.86	62.37	65.16	43.57	46.36	65.47	68.26
15-35	65.13	74.37	46.33	55.57	68.23	77.47	62.54	65.12	43.74	46.32	65.64	68.22
15-97	64.96	72.01	46.16	53.21	68.06	75.11	62.60	65.69	43.80	46.89	65.70	68.79
17-02	77.80	92.64	72.89	87.73	104.09	118.95	74.53	86.09	69.62	81.18	100.82	112.38
17-06	69.07	78.67	64.17	73.77	87.27	96.87	65.11	69.07	60.21	64.17	83.31	87.27
17-08	68.06	76.79	63.16	71.89	86.26	94.99	65.58	70.55	60.68	65.65	83.78	88.75
17-26	68.64	79.43	63.74	74.53	86.84	97.63	65.00	69.03	60.10	64.13	83.20	87.23
17-35	68.88	82.43	63.98	77.53	87.08	100.63	65.03	68.68	60.13	63.78	83.23	86.88
17-75	74.48	85.77	69.58	80.87	92.68	103.97	65.48	71.77	60.58	66.87	83.68	89.97
17-99	68.69	79.25	63.79	74.35	86.89	97.45	65.13	69.29	60.23	64.39	83.33	87.49
19-11	87.04	100.63	67.69	81.28	97.59	111.18	83.63	92.05	64.28	73.45	94.18	103.35
19-32	86.25	99.65	66.90	80.30	96.80	110.20	81.77	86.85	62.42	67.50	92.32	97.40
19-35	86.56	103.01	67.21	83.66	97.11	113.56	81.94	86.51	62.59	67.16	92.49	97.06
21-11	99.71	119.55	81.81	101.65	111.81	131.65	92.45	101.95	74.55	84.05	104.55	114.05
21-16	96.81	112.09	78.91	94.19	108.91	124.19	91.85	99.61	73.95	81.71	103.95	111.71
21-35	97.09	117.75	79.19	99.85	109.19	129.85	91.56	98.00	73.66	80.10	103.66	110.10
21-39	98.47	118.80	80.57	100.90	110.57	130.90	92.67	102.44	74.77	84.54	104.77	114.54
21-41	97.01	114.38	79.11	126.48	109.11	126.48	91.27	97.98	73.37	80.08	103.37	80.08
21-48	103.84	123.82	85.93	105.91	126.02	146.02	90.72	97.62	72.81	79.71	112.92	119.82
21-75	108.72	125.62	90.81	107.71	130.92	147.82	90.72	97.62	72.81	79.71	112.92	119.82
23-21	108.81	132.06	90.61	113.86	122.81	146.06	102.30	115.68	84.10	97.48	116.30	129.68
23-35	107.17	133.32	88.97	115.12	121.17	147.32	100.17	108.32	81.97	90.12	114.17	122.32
23-53	107.23	129.42	89.03	111.22	121.23	143.42	99.81	108.22	81.61	90.02	113.81	122.22
23-55	107.98	131.05	89.78	112.85	121.98	145.05	100.28	109.05	82.08	90.85	114.28	123.05
25-07	133.3	157.7	115.5	172.25	160.06	172.25	108.51	119.45	90.71	101.65	135.27	101.65
25-11	132.31	152.31	114.51	134.51	159.71	179.07	111.51	124.51	93.71	106.71	138.91	151.27
25-19	122.14	154.15	104.34	136.35	136.74	168.75	109.60	123.75	91.80	105.95	124.20	138.35
25-24	121.64	153.00	103.84	135.20	136.24	167.60	110.00	124.44	92.20	106.64	124.60	139.04
25-29	119.96	148.93	102.16	131.13	134.56	163.53	110.97	126.31	93.17	108.51	125.57	140.91
25-35	117.75	150.58	99.95	132.78	132.35	165.18	108.79	118.58	90.99	100.78	123.39	133.18
25-37	119.98	148.26	102.18	162.67	146.74	162.67	108.51	119.40	90.71	101.60	135.27	101.60
25-44	140.35	164.98	122.55	179.58	167.11	179.71	106.81	117.08	89.01	99.28	133.57	99.41
25-43	120.00	150.68	102.20	132.88	134.60	165.28	110.58	125.88	92.78	108.08	125.18	140.48
25-46	122.30	146.14	104.50	128.34	136.90	160.74	107.66	117.82	89.86	100.02	122.26	132.42
25-61	117.05	143.80	99.25	126.00	131.65	158.40	108.51	119.40	90.71	101.60	123.11	155.51
25-08	143.38	175.21	125.58	157.41	157.98	189.81	107.38	119.21	89.58	101.41	121.98	133.81
25-20	128.40	158.62	110.60	140.82	143.00	173.22	106.83	117.08	89.03	99.28	121.43	131.68
25-04	120.80	150.65	103.00	132.85	135.40	165.25	111.60	125.21	93.80	107.41	126.20	139.81

Weight in gram (+/- 15%)



Titanium Series

Derived from MIL-DTL-38999 Series III

8D - Titanium Series



Connector part numbers

Basic Series	8D	0	-	11	TT	35	P	N	-	-	L
Shell style:											
0: Square flange receptacle											
7: Jam nut receptacle											
5: Plug with RFI shielding											
Type:											
None: Connectors with standard crimp contacts.											
L: Receptacle with long PC tail (male and female size #22D, #20).											
C: Receptacle with short PC tail (male and female #22D, #20, #16).											
S: Receptacle with specific PC tail (male et female #22D)											
W: Receptacle with male contacts #22D for wire wrap (3 wraps)											
T: Receptacle with male contacts #20 for wire wrap (2 wraps)											
P: Receptacle with solder cup (male and female size #22D; male #16 & #12; female #16 & #12 and male female #20 please consult us)											
Shell size:											
09, 11, 13, 15, 17, 19, 21, 23, 25											
Plating:											
TT: Without plating											
TF: Nickel											
Contact layout:											
See pages 11 to 14											
Contact type:											
P: Pin											
A: Connector supplied less pin contact or with specific contacts (connector marking: A + orientation)											
S: Socket											
B: Connector supplied less socket contact or with specific contacts (connector marking: B + orientation)											
Orientation:											
N, A, B, C, D, E (see page 65)											
Specification:											
046: Tinned straight PC tail											
251: Connector provided with power contacts (layouts with contact #8)											
022: Fuel tank											
Special custom											
None: Standard plastic cap											
M: Antistatic plastic cap											
L: For P or S contact type only, connectors delivered without contacts, connectors marking P or S plus orientation.											

8D - Titanium Series



Dimensions

Receptacle type 0										
	Shell size	A Max	B Max	C Max	D Thread	E ± 0.3	F	G	H ± 0.2	J ± 0.2
	09 (A)	20.2	11.4	2.5	M12 x 1-6g	23.8	18.26	15.09	3.25	5.49
11 (B)	M15 x 1-6g				26.2	20.62	18.26	4.93		
13 (C)	M18 x 1-6g				28.6	23.01	20.62	4.4		
15 (D)	M22 x 1-6g				31	24.61	23.01	4.93		
17 (E)	M25 x 1-6g				33.3	26.97	24.61			
19 (F)	M28 x 1-6g				36.5	29.36	26.97			
21 (G)	19.8	11.8	3.2	M31 x 1-6g	39.7	31.75	29.36	3.91	6.15	
23 (H)				M34 x 1-6g	42.9	34.93	31.75			
25 (J)		11.4		M37 x 1-6g	46	38.1	34.93			

Receptacle type 7								
	Shell size	A ± 0.15	B Max	C Max	D Max	E Max	F ± 0.4	G Thread
	09 (A)	16.57	9.9	3.2	30.5	23	27	M12 x 1-6g
11 (B)	19.12	35.2			26	31.8	M15 x 1-6g	
13 (C)	23.87	38.4			31	34.9	M18 x 1-6g	
15 (D)	27.02	41.6			34	38.1	M22 x 1-6g	
17 (E)	30.2	44.8			37	41.3	M25 x 1-6g	
19 (F)	33.37	49.5			41	46	M28 x 1-6g	
21 (G)	36.55	52.7			46	49.2	M31 x 1-6g	
23 (H)	39.72	55.9			47	52.4	M34 x 1-6g	
25 (J)	42.90	59			51.23	55.6	M37 x 1-6g	

Recommended coupling torque on panel for jam nut receptacle (type 7)

Shell	09 (A)	11 (B)	13 (C)	15 (D)	17 (E)	19 (F)	21 (G)	23 (H)	25 (J)
Coupling torque (± 0.5 N.m)	4	5	7	8	9	10	12	13	14

Note: All dimensions are in millimeters (mm)

8D - Titanium Series



Plug type 5

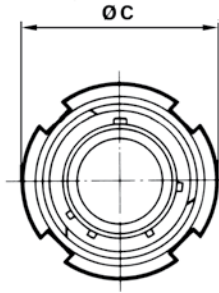
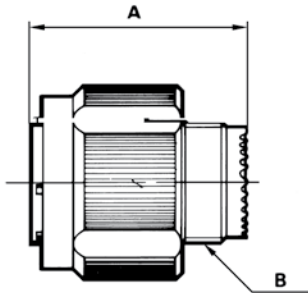

Shell size	A Max.	B thread	C Max.
09	31.00	M12 x 1-6g	21.80
11	31.00	M15 x 1-6g	25.00
13	31.00	M18 x 1-6g	29.40
15	31.00	M22 x 1-6g	32.50
17	31.00	M25 x 1-6g	35.70
19	31.00	M28 x 1-6g	38.50
21	31.00	M31 x 1-6g	41.70
23	31.00	M34 x 1-6g	44.90
25	31.00	M37 x 1-6g	48.00

Mated connectors dimensions

Type 0 with plug

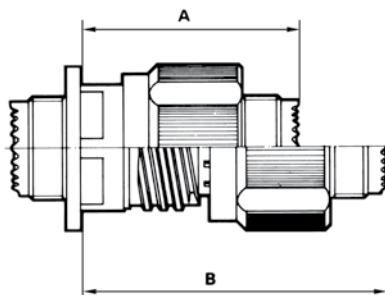

Type 7 with plug

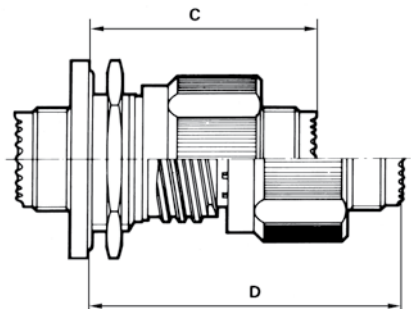

Shell size	A Max.	B Max.	C Max.	D Max.
09	37.00	52.30	38.30	53.60
11	37.00	52.30	38.30	53.60
13	37.00	52.30	38.50	53.80
15	37.00	52.30	38.50	53.80
17	37.00	52.30	38.50	53.80
19	37.00	52.30	38.50	53.80
21	36.00	51.30	38.50	53.80
23	36.00	51.30	38.50	53.80
25	36.00	51.30	38.50	53.80

Note: All dimensions are in millimeters (mm)

8D - Titanium Series



Receptacle with straight PC tail contacts



	Shell size			09 (A)	11 (B)	13 (C)	15 (C)	17 (E)	19 (F)	21 (G)	23 (H)	25 (J)	
	Contact size	Contact type	PC tail type										
A	#22D	M & F	L & C	0.70									
	#22D	M & F	S	0.50									
	#20	M & F	C	0.70									
	#16	M & F	C	1.15									
L1	Min	#22D	M	L & C	10.52								10.34
	Max	#22D	M	L & C	11.46								11.28
	Min	#22D	F	L & C	10.19								10.01
	Max	#22D	F	L & C	11.46								11.28
	Min	#22D	M	S	10.19								10.01
	Max	#22D	M	S	11.46								11.28
	Min	#22D	F	S	10.69								10.51
	Max	#22D	F	S	11.63								11.45
	Min	#20	M	C	10.36								10.18
	Max	#20	M	C	11.63								11.45
	Min	#20	F	C	10.69								10.51
	Max	#20	F	C	11.63								11.45
	Min	#16	M	C	10.69								10.51
	Max	#16	M	C	11.63								11.45
	Min	#16	F	C	10.69								10.51
	Max	#16	F	C	11.63								11.45
L2	#22D	M & F	L	8.50									
	#22D	M & F	C	4.00									
	#22D	M & F	S	5.10									
	#20	M & F	C	5.10									
	#16	M & F	C	5.10									
L3	Min	#22D	M	L & C	9.48							9.59	
	Max	#22D	M	L & C	10.58							10.69	
	Min	#22D	F	L & C	9.15							9.26	
	Max	#22D	F	L & C	10.58							10.69	
	Min	#22D	M	S	9.65							9.76	
	Max	#22D	M	S	10.75							10.86	
	Min	#22D	F	S	9.15							9.26	
	Max	#22D	F	S	10.75							10.86	
	Min	#20	M	C	9.65							9.76	
	Max	#20	M	C	10.75							10.86	
	Min	#20	F	C	9.65							9.76	
	Max	#20	F	C	10.75							10.86	
	Min	#16	M	C	9.65							9.76	
	Max	#16	M	C	10.75							10.86	
	Min	#16	F	C	9.65							9.76	
	Max	#16	F	C	10.75							10.86	

M: Male contact

F: Female contact

L: Long PC tail

C: Short PC tail

S: Specific PC tail

Dimensions in millimeters

8D - Titanium Series



Connectors weight

	With contacts						Without contact					
	Plug (type 5)		Receptacle (type 0)		Receptacle (type 7)		Plug (type 5)		Receptacle (type 0)		Receptacle (type 7)	
	Male	Female	Male	Female	Male	Female	Male	Female	Male	Female	Male	Female
09-35	18.23	19.81	14.37	15.95	20.14	21.72	17.81	18.31	13.95	14.45	19.72	20.22
09-98	18.23	19.53	14.37	15.67	20.14	21.44	17.81	18.33	13.95	14.47	19.72	20.24
11-01	23.15	26.09	18.19	21.13	25.63	28.57	22.49	24.49	17.53	19.53	24.97	26.97
11-02	22.78	25.32	17.82	20.36	28.1	30.64	22.16	23.76	17.2	18.8	27.48	29.08
11-04	22.97	26.03	18.01	21.07	25.45	28.51	22.41	24.43	17.45	19.47	24.89	26.91
11-05	23.00	26.21	18.04	21.25	25.24	28.69	22.30	24.21	17.34	19.25	24.78	26.69
11-22	22.64	25.06	17.68	20.10	27.96	30.38	22.36	24.06	17.40	19.10	27.68	29.38
11-35	22.90	26.37	17.94	21.41	25.14	28.85	21.99	23.12	17.03	18.16	24.47	25.60
11-80	25.38	29.86	20.08	24.88	30.66	35.78	22.10	22.86	16.80	17.88	27.38	28.78
11-98	22.87	25.63	17.91	20.67	25.35	28.11	22.03	23.23	17.07	18.27	24.51	25.71
11-99	23.04	26.26	18.06	21.28	25.53	28.75	22.06	23.46	17.08	18.48	24.55	25.95
13-04	32.44	36.22	23.56	27.34	34.11	37.89	31.20	33.10	22.32	24.22	32.87	34.77
13-08	32.82	38.00	23.94	29.12	34.49	39.67	31.70	34.80	22.82	25.92	33.37	36.47
13-26	33.19	38.84	24.31	29.96	34.86	40.51	31.45	34.14	22.57	25.26	33.12	35.81
13-35	32.62	38.39	23.74	29.51	34.29	40.06	31.08	32.89	22.20	24.01	32.75	34.56
13-98	32.48	37.10	23.60	28.22	34.15	38.77	31.08	33.10	22.20	24.22	32.75	34.77
15-05	39.61	44.95	28.77	34.11	41.40	46.74	38.06	41.05	27.22	30.21	39.85	42.84
15-15	40.41	47.57	29.57	36.73	42.20	49.36	38.14	41.19	27.30	30.35	39.93	42.98
15-18	40.62	49.50	29.78	38.66	42.41	51.29	38.10	42.30	27.26	31.46	39.89	44.09
15-19	40.15	47.88	29.31	37.04	41.94	49.67	37.49	40.28	26.65	29.44	39.28	42.07
15-35	40.25	49.49	29.41	38.65	42.04	51.28	37.66	40.24	26.82	29.40	39.45	42.03
15-97	40.08	47.13	29.24	36.29	41.87	48.92	37.72	40.81	26.88	29.97	39.51	42.60
17-02	48.16	58.40	45.20	55.44	63.99	74.23	44.89	51.85	41.93	48.89	60.72	67.68
17-06	43.73	53.33	40.90	50.50	54.23	63.83	39.77	43.73	36.94	40.90	50.27	54.23
17-08	42.72	51.45	39.89	48.62	53.22	61.95	40.24	45.21	37.41	42.38	50.74	55.71
17-26	43.30	54.09	40.47	51.26	53.80	64.59	39.66	43.69	36.83	40.86	50.16	54.19
17-35	43.54	57.09	40.71	54.26	54.04	67.59	39.69	43.34	36.86	40.51	50.19	53.84
17-75	49.14	60.43	46.31	57.60	59.64	70.93	40.14	46.43	37.31	43.60	50.64	56.93
17-99	43.35	53.91	40.52	51.08	53.85	64.41	39.79	43.95	36.96	41.12	50.29	54.45
19-11	55.16	68.75	44.00	57.59	61.25	74.84	51.75	60.17	40.59	66.26	40.59	66.26
19-32	54.37	67.77	43.21	56.61	60.46	73.86	49.89	54.97	38.73	61.06	38.73	61.06
19-35	54.68	71.13	43.52	59.97	60.77	77.22	50.06	54.63	38.90	60.72	38.90	60.72
21-11	64.64	84.48	54.31	74.15	71.62	91.46	57.38	66.88	47.05	73.86	47.05	73.86
21-16	61.74	77.02	51.41	66.69	68.72	84.00	56.78	64.54	46.45	71.52	46.45	71.52
21-35	62.02	82.68	51.69	72.35	69.00	89.66	56.49	62.93	46.16	69.91	46.16	69.91
21-39	63.40	83.73	53.07	73.40	70.38	90.71	57.60	67.37	47.27	74.35	47.27	74.35
21-41	61.94	79.31	51.61	86.29	68.92	86.29	56.20	62.91	45.87	69.89	45.87	69.89
21-48	68.73	88.71	58.4	78.38	81.56	101.54	55.61	62.51	45.28	52.18	68.44	75.34
21-75	73.61	90.51	63.28	80.18	86.44	103.34	55.61	62.51	45.28	52.18	68.44	75.34
23-21	71.07	94.32	60.57	83.82	79.15	102.40	64.56	77.94	54.06	86.02	54.06	86.02
23-35	69.43	95.58	58.93	85.08	77.51	103.66	62.43	70.58	51.93	78.66	51.93	78.66
23-53	69.49	91.68	58.99	81.18	77.57	99.76	62.07	70.48	51.57	78.56	51.57	78.56
23-55	70.24	93.31	59.74	82.81	78.32	101.39	62.54	71.31	52.04	79.39	52.04	79.39
25-07	83.91	117.09	73.64	123.58	99.34	121.8	68.12	78.84	57.85	85.33	83.55	83.55
25-11	91.92	111.92	81.65	101.65	94.65	127.35	71.12	84.12	60.85	73.85	86.55	99.55
25-19	81.78	113.79	71.51	103.52	90.20	122.21	69.24	83.39	58.97	91.81	58.97	91.81
25-24	81.28	112.64	71.01	102.37	89.70	121.06	69.64	84.08	59.37	92.50	59.37	92.50
25-29	79.60	108.57	69.33	98.30	88.02	116.99	70.61	85.95	60.34	94.37	60.34	94.37
25-35	77.39	110.22	67.12	99.95	85.81	118.64	68.43	78.22	58.16	86.64	58.16	86.64
25-37	79.59	107.09	69.32	116.12	95.02	113.36	68.12	79.04	57.85	87.26	83.55	84.50
25-44	99.96	127.50	89.69	134.23	115.39	134.44	66.42	77.85	56.15	86.33	81.85	84.54
25-43	79.64	110.32	69.37	100.05	88.06	118.74	70.22	85.52	59.95	93.94	59.95	93.94
25-46	81.94	105.78	71.67	95.51	90.36	114.20	67.30	77.46	57.03	85.88	57.03	85.88
25-61	76.69	103.44	66.42	93.17	85.11	111.86	68.15	79.04	57.88	87.46	57.88	87.46
25-08	103.02	134.85	92.75	124.58	111.44	143.27	67.02	78.85	56.75	87.27	56.75	87.27
25-20	88.04	118.26	77.77	107.99	96.46	126.68	66.47	76.72	56.20	85.14	56.20	85.14
25-04	80.44	110.29	70.17	100.02	88.86	118.71	71.24	84.85	60.97	93.27	60.97	93.27

Weight in gram (+/- 15%)

* Please, consult us for weight of receptacles type 77.

38999 Bronze Series



CECC approved

CECC 75.201.00

38999 Bronze Series



Connector part numbers

Basic Series	JVS	16	A	11	35	P	N	-
Shell style:								
00: Square flange receptacle								
07: Jam nut receptacle								
16: Plug with RFI shielding								
Material:								
A: Bronze housing material								
Shell size:								
09, 11, 13, 15, 17, 19, 21, 23, 25								
Contact layout:								
See pages 11 to 14								
Contact type:								
P: Pin	A: Connector supplied less pin contact or with specific contacts (connector marking: A + orientation)							
S: Socket	B: Connector supplied less socket contact or with specific contacts (connector marking: B + orientation)							
Orientation:								
N, A, B, C, D, E (see page 65)								
Specification:								
251: Connector provides with power contacts (layouts with contacts #8)								
CI: Printed board mounting contacts								
LI: Receptacle with long PC tail (pin or socket #22D)								
L: For P or S contact type only, connectors delivered without contacts, connectors marking P or S plus orientation								

CECC part numbers

Basic Series	C 752 002	B	B	98	P	C	N	A	0	1	G
Shell style:											
A: Plug											
B: Square flange receptacle											
C: Jam nut receptacle											
Shell size:											
09=A, 11=B, 13=C, 15=D, 17=E, 19=F, 21=G, 23=H, 25=J											
Contact layout:											
See pages 11 to 14											
Contact type:											
P: Pin											
S: Socket											
Type of contact termination:											
C: Crimp contact											
Orientation:											
N, A, B, C, D, E (see page 65)											
Shell material:											
A: Aluminum bronze											
Supply code:											
0: Connectors supplied with contacts											
1: Connectors supplied without contacts											
Assessment level:											
1: Level 1											
Performance level:											
G: Level G											

Note: C 752 002 refers to the abbreviated form of the CECC 75 201-002 type designation.

38999 Bronze Series



Dimensions

Receptacle type 00 (JVS) or type B (CECC)

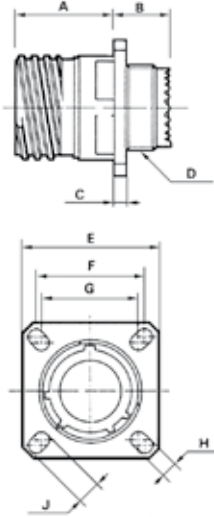

Shell size	A Max	B Max	C Max	D Thread	E ± 0.3	F	G	H ± 0.2	J ± 0.2
09 (A)	20.2	11.4	2.5	M12 x 1-6g	23.8	18.26	15.09	3.25	5.49
11 (B)				M15 x 1-6g	26.2	20.62	18.26		4.93
13 (C)				M18 x 1-6g	28.6	23.01	20.62		4.4
15 (D)				M22 x 1-6g	31	24.61	23.01		4.93
17 (E)				M25 x 1-6g	33.3	26.97	24.61		
19 (F)				M28 x 1-6g	36.5	29.36	26.97		
21 (G)	19.8	11.8	3.2	M31 x 1-6g	39.7	31.75	29.36	3.91	6.15
23 (H)		11.4		M34 x 1-6g	42.9	34.93	31.75		
25 (J)				M37 x 1-6g	46	38.1	34.93		

Receptacle type 07 (JVS) or type C (CECC)

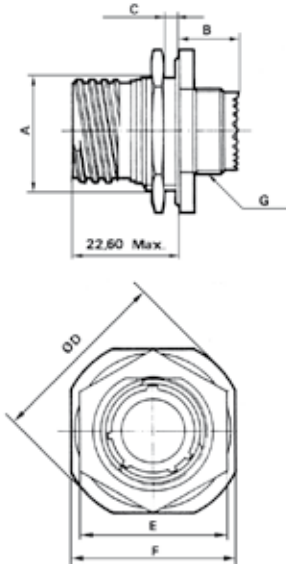

Shell size	A ± 0.15	B Max	C Max	D Max	E Max	F ± 0.4	G Thread
09 (A)	16.57	9.9	3.2	30.5	23	27	M12 x 1-6g
11 (B)	19.12			35.2	26	31.8	M15 x 1-6g
13 (C)	23.87			38.4	31	34.9	M18 x 1-6g
15 (D)	27.02			41.6	34	38.1	M22 x 1-6g
17 (E)	30.2			44.8	37	41.3	M25 x 1-6g
19 (F)	33.37			49.5	41	46	M28 x 1-6g
21 (G)	36.55			52.7	46	49.2	M31 x 1-6g
23 (H)	39.72			55.9	47	52.4	M34 x 1-6g
25 (J)	42.90			59	51.23	55.6	M37 x 1-6g

Recommended coupling torque on panel for jam nut receptacle (type 7)

Shell	09 (A)	11 (B)	13 (C)	15 (D)	17 (E)	19 (F)	21 (G)	23 (H)	25 (J)
Coupling torque (± 0.5 N.m)	4	5	7	8	9	10	12	13	14

Note: All dimensions are in millimeters (mm)

38999 Bronze Series



Plug type 16 (JVS) or type A (CECC)

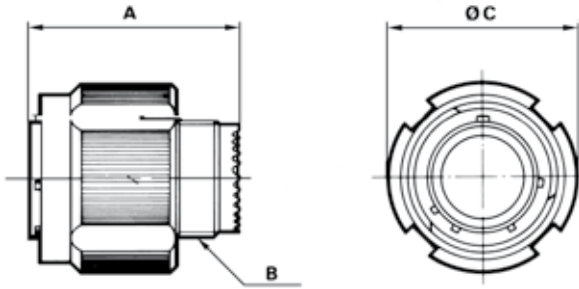

Shell size	A Max.	B thread	C Max.
09 (A)	31.00	M12 x 1-6g	21.10
11 (B)	31.00	M15 x 1-6g	23.80
13 (C)	31.00	M18 x 1-6g	28.20
15 (D)	31.00	M22 x 1-6g	31.40
17 (E)	31.00	M25 x 1-6g	36.50
19 (F)	31.00	M28 x 1-6g	39.30
21 (G)	31.00	M31 x 1-6g	42.50
23 (H)	31.00	M34 x 1-6g	45.30
25 (J)	31.00	M37 x 1-6g	48.40

Mated connectors dimensions

Type 00 with plug

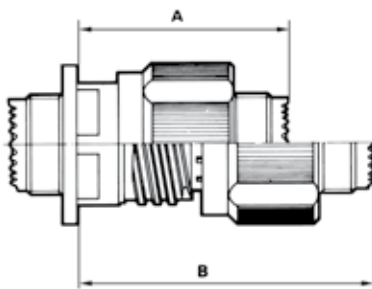

Type 7 with plug

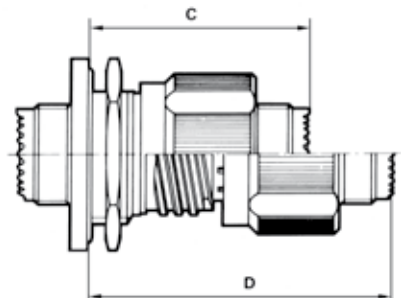

Shell size	A Max.	B Max.	C Max.	D Max.
09 (A)	37.00	52.30	38.30	53.60
11 (B)	37.00	52.30	38.30	53.60
13 (C)	37.00	52.30	38.30	53.60
15 (D)	37.00	52.30	38.30	53.60
17 (E)	37.00	52.30	38.30	53.60
19 (F)	37.00	52.30	38.30	53.60
21 (G)	36.00	51.30	38.30	53.60
23 (H)	36.00	51.30	38.30	53.60
25 (J)	36.00	51.30	38.30	53.60

Note: All dimensions are in millimeters (mm)

38999 Bronze Series



Receptacle with straight PC tail contacts (CI & TI specification)

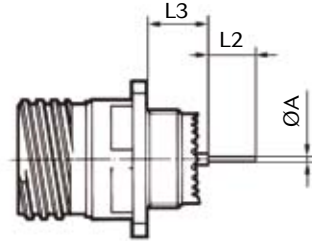
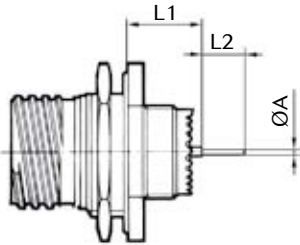

	Shell size			09 (A)	11 (B)	13 (C)	15 (C)	17 (E)	19 (F)	21 (G)	23 (H)	25 (J)
	Contact size	Contact type	PC tail type									
A	#22D	M & F	L					0.70				
	#22D	M & F	C					0.50				
	#20	M & F	C					0.70				
	#16	M & F	C					1.15				
L1	Min	#22D	M	L	10.52				10.34			
	Max	#22D	M	L	11.46				11.28			
	Min	#22D	F	L	10.19				10.01			
	Max	#22D	F	L	11.46				11.28			
	Min	#22D	M	C	10.19				10.01			
	Max	#22D	M	C	11.46				11.28			
	Min	#22D	F	C	10.69				10.51			
	Max	#22D	F	C	11.63				11.45			
	Min	#20	M	C	10.36				10.18			
	Max	#20	M	C	11.63				11.45			
	Min	#20	F	C	10.69				10.51			
	Max	#20	F	C	11.63				11.45			
	Min	#16	M	C	10.69				10.51			
	Max	#16	M	C	11.63				11.45			
	Min	#16	F	C	10.69				10.51			
	Max	#16	F	C	11.63				11.45			
L2	#22D	M & F	L					8.50				
	#22D	M & F	C					5.10				
	#20	M & F	C					5.10				
	#16	M & F	C					5.10				
L3	Min	#22D	M	L		9.48					9.59	
	Max	#22D	M	L		10.58					10.69	
	Min	#22D	F	L		9.15					9.26	
	Max	#22D	F	L		10.58					10.69	
	Min	#22D	M	C		9.65					9.76	
	Max	#22D	M	C		10.75					10.86	
	Min	#22D	F	C		9.15					9.26	
	Max	#22D	F	C		10.75					10.86	
	Min	#20	M	C		9.65					9.76	
	Max	#20	M	C		10.75					10.86	
	Min	#20	F	C		9.65					9.76	
	Max	#20	F	C		10.75					10.86	
	Min	#16	M	C		9.65					9.76	
	Max	#16	M	C		10.75					10.86	
	Min	#16	F	C		9.65					9.76	
	Max	#16	F	C		10.75					10.86	

M: Male contact

F: Female contact

L: Long PC tail

C: Short PC tail

Dimensions in millimeters

38999 Bronze Series



Backshell part numbers

Basic Series	JVS	A	11	A	00	C	SB
Accessory style							
A : Rear accessory (backshell)							
Shell size:							
09, 11, 13, 15, 17, 19, 21, 23, 25							
Accessory type:							
A: Screened adaptor for use with compression spring or band strap							
B: Adaptor with strain relief cable clamp							
E: Screened adaptor with braid trap							
G: Environmental cone clamp screened adaptor							
P: Adaptor for heat shrink boot							
X: Cone clamp screened adaptor							
Cable entry size:							
For B type:							
00: Standard, by default choice							
For other types:							
00: Standard, by default choice							
03 to 32: Depending on backshell type, please refer to corresponding table							
Angle:							
A: Straight backshell (orientation by default)							
B: 45° backshell (except for «B Type» accessory)							
C: 90° right angle backshell							
Variant:							
For all types:							
None: Supplied without any other accessory							
For E, X and G type:							
CC: Cable clamp variant							

38999 Bronze Series



A Type - Screened adaptor for use with compression spring or band strap

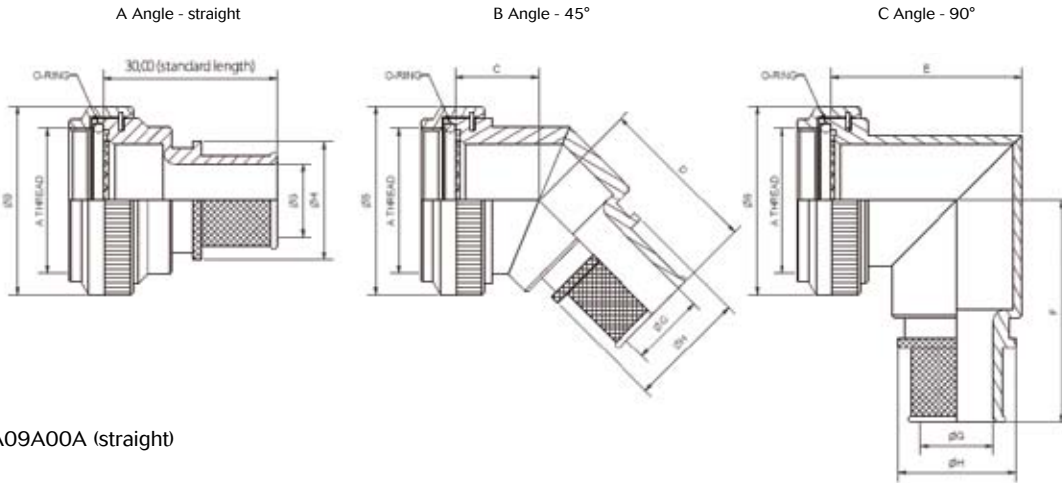

Example: JVSA09A00A (straight)

Shell Size	A Thread	B Max	C Max	D Max	E Max	F Max	Max Entry*
09	M12 x 1.0	18.0	13.1	24.7	25.5	30.5	04
11	M15 x 1.0	21.0	13.9	25.9	26.5	32.2	06
13	M18 x 1.0	24.5	14.5	26.3	31.0	33.7	08
15	M22 x 1.0	29.0	15.5	27.2	37.0	35.2	10
17	M25 x 1.0	32.5	16.1	28.0	40.0	36.9	12
19	M28 x 1.0	35.5	16.8	28.3	44.5	38.5	13
21	M31 x 1.0	37.0	17.1	29.1	49.0	40.1	16
23	M34 x 1.0	40.0	17.7	29.5	51.5	41.6	18
25	M37 x 1.0	43.5	18.4	30.4	53.0	43.1	20

Entry Size	G	H Max	Entry Size	G	H Max
03	4.77	13.9	12	19.05	26.7
04	6.35	13.9	13	20.62	28.3
05	7.92	15.5	14	22.23	29.9
06	9.52	17.2	15	23.82	31.5
07	11.10	18.7	16	25.40	33.1
08	12.70	20.3	17	27.00	34.7
09	14.27	21.9	18	28.60	36.3
10	15.88	23.5	19	30.20	37.9
11	17.47	25.1	20	31.80	39.5

* Recommendation only, please consult us for outside entry size

B Type - Adaptor with strain relief cable clamp

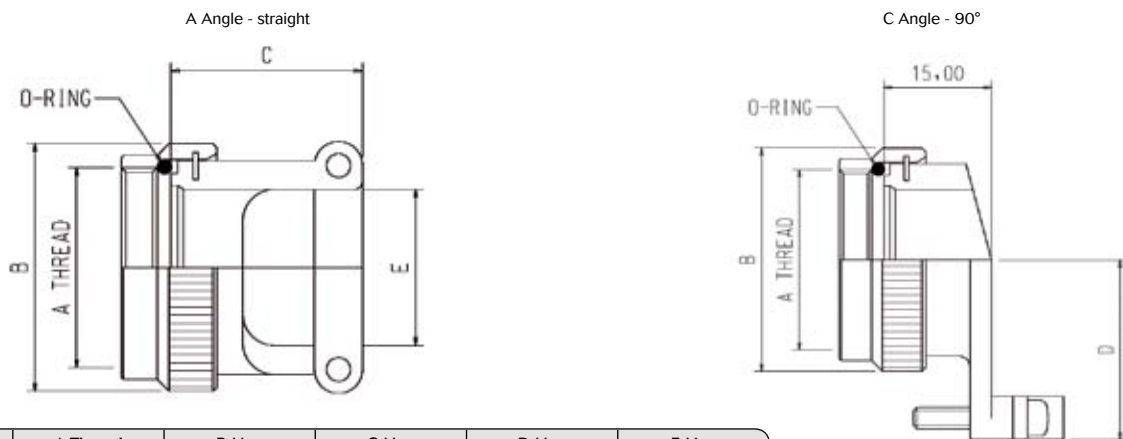

Shell Size	A Thread	B Max	C Max	D Max	E Max
09	M12 x 1.0	18.0	21.5	20.0	7.0
11	M15 x 1.0	21.0	21.5	21.0	10.5
13	M18 x 1.0	24.5	23.5	22.0	13.4
15	M22 x 1.0	29	23.5	23.0	16.5
17	M25 x 1.0	32.5	24.5	25.0	19.7
19	M28 x 1.0	35.5	27.5	27.5	22.2
21	M31 x 1.0	37.0	34.5	30.0	25.6
23	M34 x 1.0	40.0	37.5	31.5	28.5
25	M37 x 1.0	43.5	37.5	34.5	31.7

Example: JVSA09B00A (straight)

Note: All dimensions are in millimeters (mm)

38999 Bronze Series



E Type - Screened adaptor with braid trap

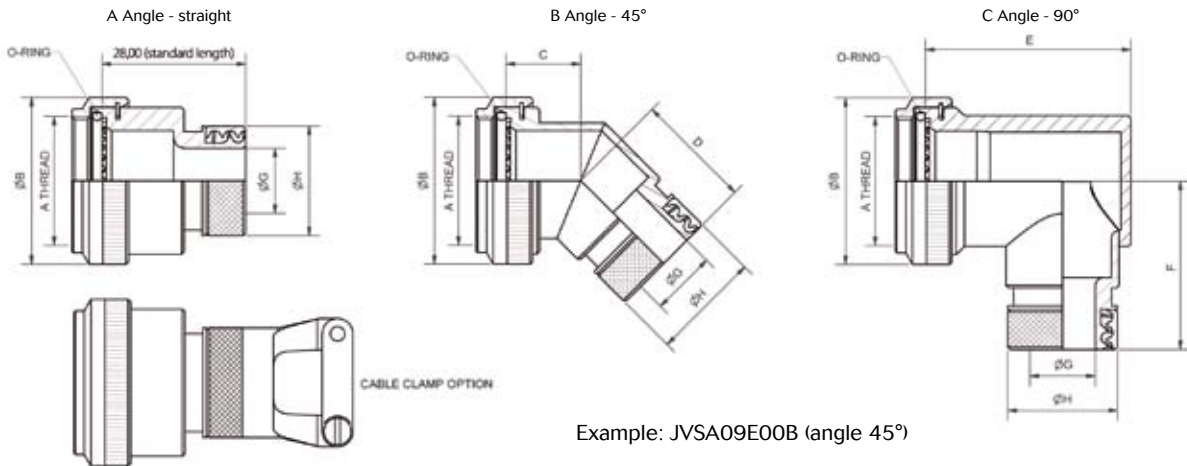

Example: JVSA09E00B (angle 45°)

Shell Size	A Thread	B Max	C Max	D Max	E Max	F Max	Max Entry
09	M12 x 1.0	18.0	13.1	23.6	25.7	30.5	04
11	M15 x 1.0	21.0	13.9	24.4	26.7	32.2	06
13	M18 x 1.0	24.5	14.5	24.8	31.2	33.7	08
15	M22 x 1.0	29.0	15.5	25.6	37.2	35.2	10
17	M25 x 1.0	32.5	16.1	26.4	40.2	36.9	12
19	M28 x 1.0	35.5	16.8	26.8	44.7	38.5	13
21	M31 x 1.0	37.0	17.1	27.6	49.2	40.1	16
23	M34 x 1.0	40.0	17.7	28.0	51.7	41.6	18
25	M37 x 1.0	43.5	18.4	29.0	53.2	43.1	20

Entry Size	G	H Max	Entry Size	G	H Max
03	4.77	15.0	12	19.05	27.7
04	6.35	15.0	13	20.62	29.3
05	7.92	16.6	14	22.23	30.9
06	9.52	18.2	15	23.82	32.5
07	11.10	19.8	16	25.40	34.1
08	12.70	21.4	17	27.00	35.7
09	14.27	23.0	18	28.60	37.3
10	15.88	24.6	19	30.20	39.1
11	17.47	26.2	20	31.80	40.4

G Type - Environmental cone clamp screened adaptor

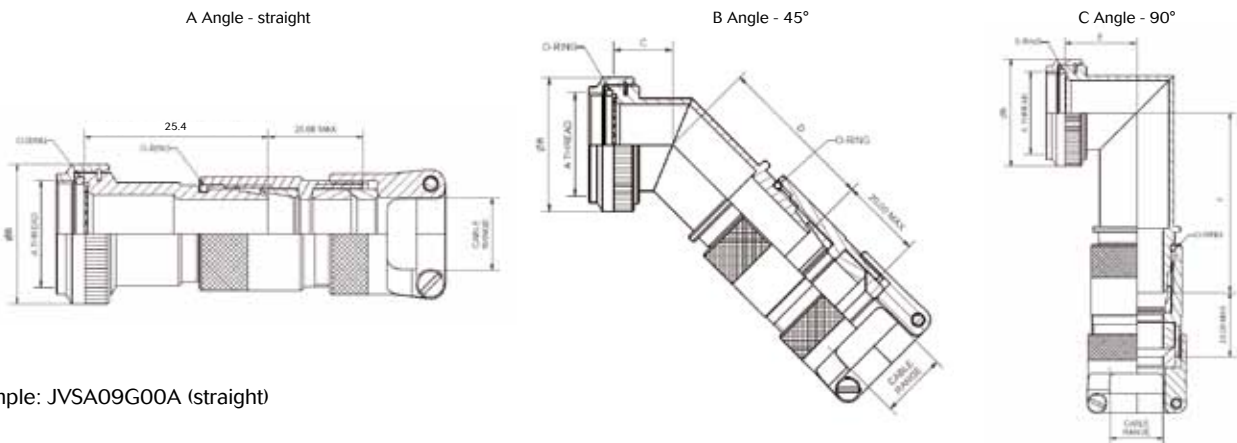

Example: JVSA09G00A (straight)

Shell Size	A Thread	B Max	C Max	D Max	E Max	F Max	Max Entry
09	M12 x 1.0	18.0	13.1	30.5	15.8	39.2	-
11	M15 x 1.0	21.0	13.9	30.5	17.6	42.3	04
13	M18 x 1.0	24.5	14.5	32.5	19.0	42.8	06
15	M22 x 1.0	29.0	15.5	40.3	21.5	50.5	10
17	M25 x 1.0	32.5	16.1	43.1	23.1	52.8	12
19	M28 x 1.0	35.5	16.8	47.9	24.5	57.1	12
21	M31 x 1.0	37.0	17.1	47.9	25.3	57.1	16
23	M34 x 1.0	40.0	17.7	56.5	27.5	64.7	16
25	M37 x 1.0	43.5	18.4	56.5	28.3	64.7	16

Entry Size	Cable Range
04	3.2 - 7.9
06	6.4 - 11.1
08	9.8 - 14.3
10	8.9 - 15.9
12	12.7 - 19.1
16	15.9 - 23.8

Note: All dimensions are in millimeters (mm)

38999 Bronze Series



P Type - Adaptor for heat shrink boot

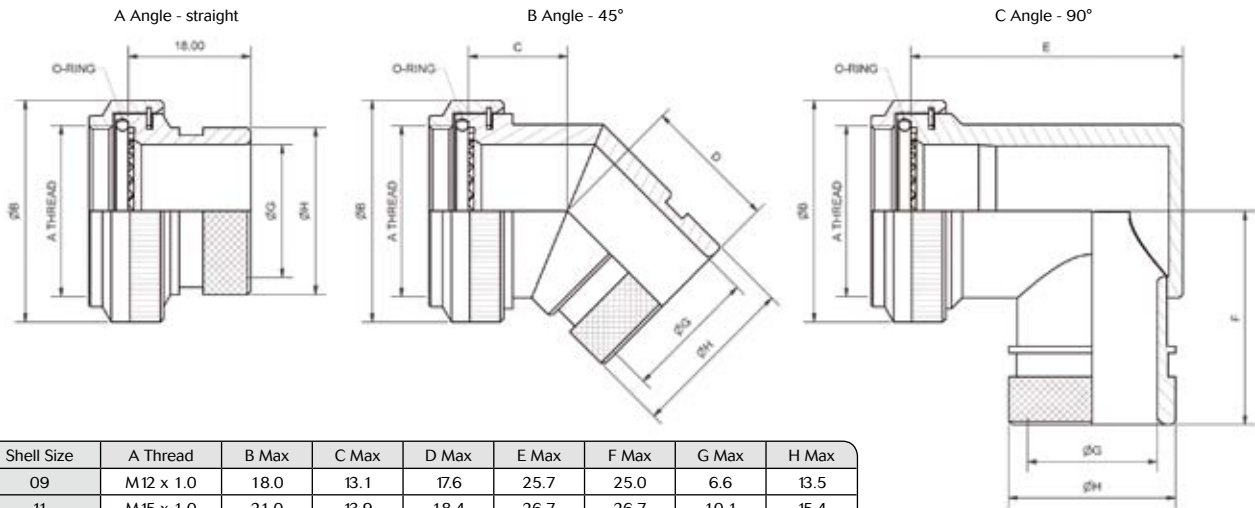

Shell Size	A Thread	B Max	C Max	D Max	E Max	F Max	G Max	H Max
09	M12 x 1.0	18.0	13.1	17.6	25.7	25.0	6.6	13.5
11	M15 x 1.0	21.0	13.9	18.4	26.7	26.7	10.1	15.4
13	M18 x 1.0	24.5	14.5	19.3	31.2	28.2	13.4	19.7
15	M22 x 1.0	29	15.5	19.6	37.2	29.7	16.1	21.3
17	M25 x 1.0	32.5	16.1	20.4	40.2	31.4	19.3	24.5
19	M28 x 1.0	35.5	16.8	20.8	44.7	33.0	21.7	26.5
21	M31 x 1.0	37.0	17.1	21.6	49.2	34.6	25	31.0
23	M34 x 1.0	40.0	17.7	22.5	51.7	36.1	28.1	34.4
25	M37 x 1.0	43.5	18.4	22.9	53.2	37.6	31.3	36.6

Example: JVSA09P00C (angle 90°)

X Type - Cone clamp screened adaptor

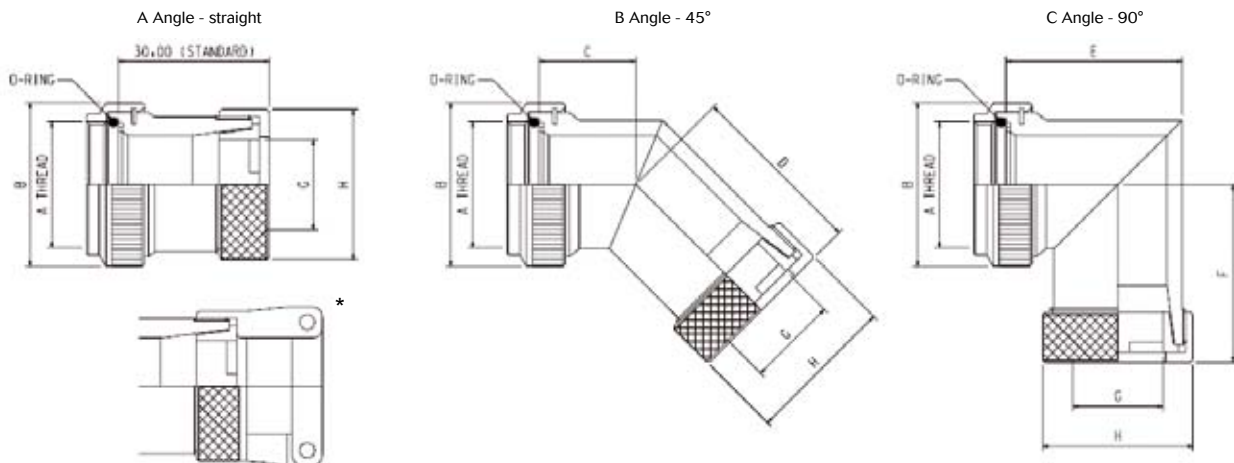

Shell Size	A Thread	B Max	C Max	D Max	E Max	F Max	G	H Max
09	M12 x 1.0	18.0	13.1	24.6	22.7	26.5	6.8	16.0
11	M15 x 1.0	21.0	13.9	25.4	26.2	28.2	9.5	19.0
13	M18 x 1.0	24.5	14.5	26.3	29.2	29.7	12.8	22.0
15	M22 x 1.0	27.5	15.5	26.7	32.2	31.2	14.8	25.4
17	M25 x 1.0	31.0	16.1	27.5	35.7	32.9	17.9	28.5
19	M28 x 1.0	34.0	16.8	27.8	39.7	34.5	20.0	32.0
21	M31 x 1.0	37.0	17.1	28.6	42.2	36.1	23.0	35.0
23	M34 x 1.0	40.0	17.7	29.5	45.2	37.6	26.4	38.0
25	M37 x 1.0	43.5	18.4	29.9	48.2	39.1	29.3	41.0

Example: JVSA09X00B (angle 45°)

* Stainless steel clamp

Note: All dimensions are in millimeters (mm)

38999 Bronze Series



Dummy receptacle

Orientations & dimensions

Orientations:

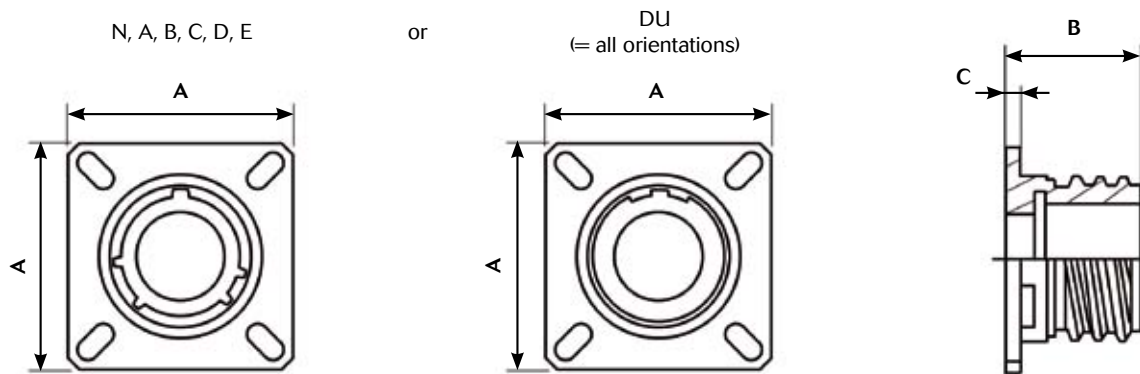

Shell size	9	11	13	15	17	19	21	23	25
A ^{+0.3} _{-0.3}	23.8	26.2	28.6	31	33.3	36.5	39.7	42.9	46
B maxi	24.2	24.2	24.2	24.2	24.2	24.2	24.1	24.1	24.1
C maxi	2.5	2.5	2.5	2.5	2.5	2.5	3.2	3.2	3.2

Examples of Part Number:

. JVS BN 02 A 17 N

. JVS BN 02 A 17 DU

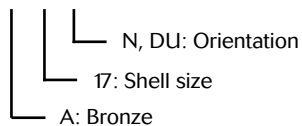

Equivalent to CECC blind hole. For information only: CECC75201002AxA00A (x = shell size A, B, C, D, ...)
 CECC75201002EA00A (blind hole) = JVSBN02A17DU (through hole)
 (no correspondance CECC with N, A, B, C, D, E orientations)

Note: All dimensions are in millimeters (mm)

38999 Bronze Series



Caps

Basic Series	JVS	B	09	B	00	A
Accessory style: B: Protective cap						
Shell size: 09, 11, 13, 15, 17, 19, 21, 23, 25						
Variant: A or B: Cap for plug (see drawing below) C or D: Cap for receptacle (see drawing below)						
Sub variant: Not applicable						
Material: A: Bronze						

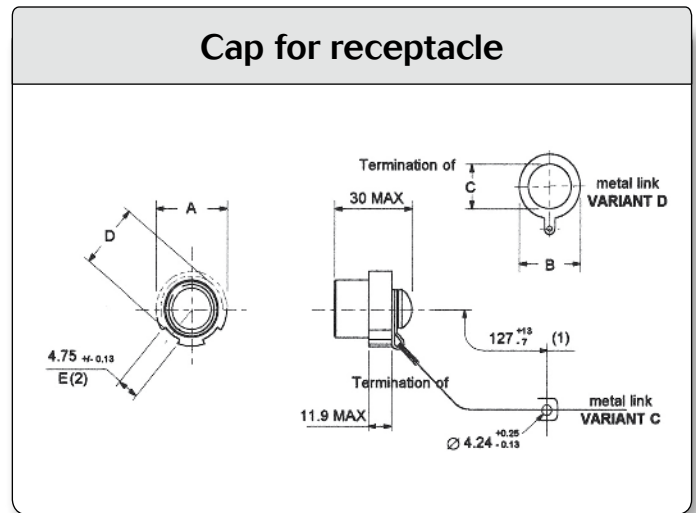
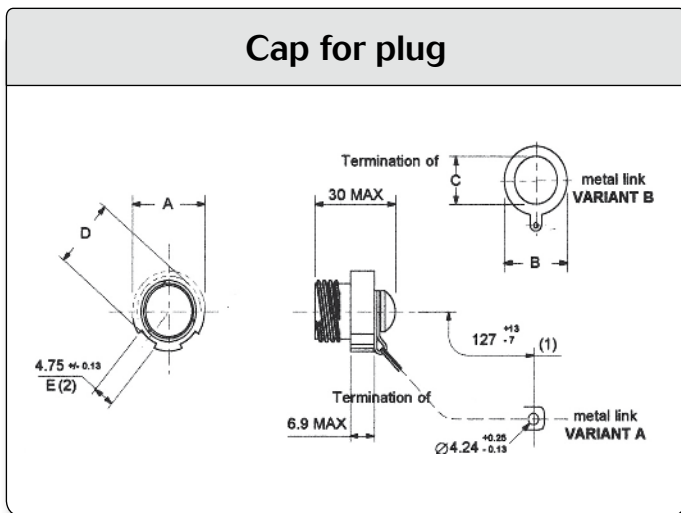

- (1) Flexible metal link
- (2) Number of notch on A diameter

Shell size	A Max.	Variant B		Variant D		D Max.	E
		B Max.	C Min.	B Max.	C Min.		
09	21.1	24.20	13.50	26.80	18.40	19.20	8
11	23.8	26.80	18.40	31.60	23.00	21.80	
13	28.2	30.50	19.80	36.90	26.20	26.10	10
15	31.4	31.60	23.00	40.10	29.40	29.30	
17	36.5	36.90	26.20	43.20	32.50	34.40	12
19	39.3	40.10	29.40	46.40	35.70	37.20	
21	42.5	43.20	32.50	49.20	39.10	40.50	16
23	45.3	46.40	35.70	52.80	42.10	43.10	
25	48.4	49.20	39.10	55.50	45.30	46.10	18

Equivalent to CECC, for information CECC75201002Bxy00A (x = shell size, y = variant)
Example: CECC75201002BAC00A = JVS B09C00A

Note: All dimensions are in millimeters (mm)



Contents

• Orientations	65
• Panel cut-out	65
• Crimp contacts	66
• Straight PC tail contacts	68
• Coaxial contacts # 12	69
• Solder cup	69
• Crimp contacts: 1500 mating	69
• Wire wrap contacts	69
• Quadrax #8 contacts	69
• Thermocouple contacts	70
• Dummy contacts	70
• Filler plugs	70
• Insertion and extraction tools	71
• Crimping tools	71
• Wiring instructions	
Cable preparation and wire stripping	72
Insertion of wire in contact barrel	72
Insertion of the contacts	72
Extraction of the contacts	73
Backshell tightening and slackening tools	73
Tightening support	73
• Gaskets	74
• Plastic protective caps	74

Common Section



Orientations

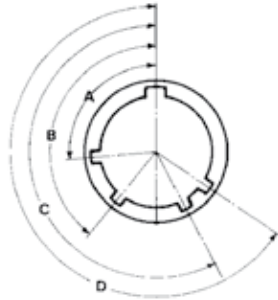

Viewed from front face of receptacle

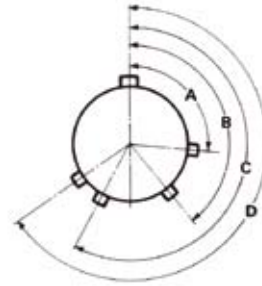

Viewed from front face of plug

Shell size	Angles	N	A	B	C	D	E
9 (A)	A°	105	102	80	35	64	91
	B°	140	132	118	140	155	131
	C°	215	248	230	205	234	197
	D°	265	320	312	275	304	240
11 (B), 13 (C) & 15 (D)	A°	95	113	90	53	119	51
	B°	141	156	145	156	146	141
	C°	208	182	195	220	176	184
	D°	236	292	252	255	298	242
17 (E), 19 (F), 21 (G), 23 (H), & 25 (J)	A°	80	135	49	66	62	79
	B°	142	170	169	140	145	153
	C°	196	200	200	200	180	197
	D°	293	310	244	257	280	272

Panel cut-out

Square flange receptacle (Type 0)

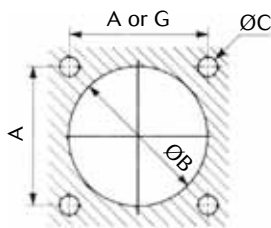

Rear mounting

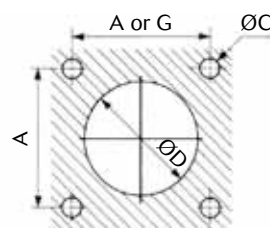

Front mounting

Jam nut receptacle (Type 7)

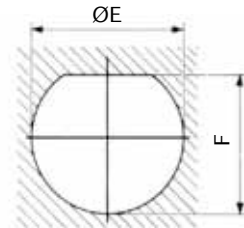

Shell size	A	G	B min.	C ±0.13	D min.	E ±0.25	F
9 (A)	18.26	15.09	16.66	3.25	13.11	17.78	17.02
11 (B)	20.62	18.26	20.22		15.88	20.96	19.59
13 (C)	23.01	20.62	23.42		19.05	25.65	24.26
15 (D)	24.61	23.01	26.59		23.01	28.83	27.56
17 (E)	26.97	24.61	30.96		25.81	32.01	30.73
19 (F)	29.36	26.97	32.94		28.98	35.18	33.91
21 (G)	31.75	29.36	36.12		32.16	38.35	37.08
23 (H)	34.93	31.75	39.29	3.91	34.93	41.53	40.26
25 (J)	38.10	34.94	42.47		37.69	44.70	43.43











Max. thickness panel for receptacle: Type 0: front mounting = 3.2 mm, rear mounting = 2.5 mm
Type 7: 3.2 mm

Note: All dimensions are in millimeters (mm)

Common Section



Crimp contacts

Contact size	Contact type	Souriau Part number (without color code)	MIL-DTL-38999 contacts		
			Part number	Profile and color code	
#22D	Pin	8599-0702 JJ	M39029/58 360	 Black / Blue / Orange	
	Socket	8599-0706 900	M39029/56 348	 Grey / Yellow / Orange	
#20	Pin	8599-0703 SA	M39029/58 363	 Orange / Blue / Orange	
	Socket	8599-0707 900	M39029/56 351	 Brown / Green / Orange	
#16	Pin	8599-0704 MJ	M39029/58 364	 Yellow / Blue / Orange	
	Socket	8599-0708 900	M39029/56 352	 Red / Green / Orange	
#16 Coaxial	Pin	-	M39029/76 424	 Yellow / Red / Yellow	
	Socket	-	M39029/77 428	 Grey / Red / Yellow	
#12	Pin	8599-0705 MJ	M39029/58 365	 Green / Blue / Orange	
	Socket	8599-0709 900	M39029/56 353	 Orange / Green / Orange	
#12 Coaxial	Pin	-	M39029/102 558		
	Socket	-	M39029/103 559		
	Pin	-	M39029/28 211		
	Socket	-	M39029/75 416		
#10 Power	Pin	-	M39029/58 528		
	Socket	-	M39029/56 527		
#8 Power	Pin	8599-7544 *	-		
	Socket	8599-7541 *	-		
	Pin	8599-7580	-		
	Socket	8599-7581	-		
	Boot		8599-4542	-	For wire #8
			8599-4547	-	For wire #10
Reductor	8599-7645	-			
#8 Coaxial	Pin	-	M39029/60 367		
	Socket	-	M39029/59 366		
	Boot	8590-4571	-		
#8 Triaxial	Pin	-	M39029/90 529		
	Socket	-	M39029/91 530		
	Boot	8590-4571	-		
#4 Power	Pin	8599-7598 900 **	-	For wire 25 mm ²	
	Socket	8599-7599 900 **	-		
	Pin	8599-7534	-	For wire 21.15 mm ²	
	Socket	8599-7535	-		
	Boot	for cable 16 mm ²	8599-4594	-	
		for cable 10 mm ²	8599-4593	-	
Reductor cable 10 mm ²	8400-2351A	-			
#4 Power with reduced barrel	Pin	8599-7528 900	-	Mating part #4 / Barrel #6	
	Socket	8599-7529 900	-		
	Boot	8599-4593	-		

* JVS only. ** Not included in connector Part number. Must be ordered separately.

Common Section



Crimp contacts

Contact size	Contact type	Contact Ø	Conductor section				External Ø over insulator	
			AWG		mm ²		Min	Max
			Min	Max	Min	Max	Min	Max
#22D	Pin	0.76	28	22	0.095	0.34	0.76	1.37
	Socket							
#20	Pin	1.00	24	20	0.21	0.60	1.02	2.11
	Socket							
#16	Pin	1.60	20	16	0.60	1.34	1.65	2.77
	Socket							
#16 Coaxial	Pin	1.60	RG 174 RG 179 RG 316				1.65	2.60
	Socket							
#12	Pin	2.40	14	12	1.91	3.18	2.46	3.61
	Socket							
#12 Coaxial	Pin	2.40	RG 174 RG 179 RG 316				2.40	2.60
	Socket							
	Pin							
	Socket							
#10 Power	Pin	3.20	Please consult us				-	2.95
	Socket							
#8 Power	Pin	3.64	-	8	-	8.98	-	-
	Socket		-	-	-	-	4.50	6.50
	Boot		-	-	-	-	2.50	4
	Reductor		-	-	-	-	-	-
	Reductor		-	-	-	-	-	-
#8 Coaxial	Pin	3.64	RG 180 A/U				-	2.80
	Socket							
	Boot							
#8 Triaxial	Pin	5.50	0,76MIL-C17/176 00002 FILECA F.2703/14 RAYCHEM CHEMINAX 10612 FILOTEX M 17/176 00002				3.15	3.40
	Socket							
	Boot							
#4 Power	Pin	5.74	-	3	-	25	-	-
	Socket		5	4	16	21.15	-	-
	Pin		-	-	-	-	6.35	7.50
	Socket		-	-	-	-	4	5.80
	Boot		-	-	-	-	-	-
	Reductor		-	-	-	-	-	-
	Reductor cable 10 mm ²		-	-	-	-	-	-
#4 Power with reduced barrel	Pin	5.74	6		13.3		-	-
	Socket		-	-	-	-	4	5.80
	Boot		-	-	-	-	-	-

Common Section



Straight PC tail contacts

Contact size	Contact type	PC tail type	Part number	Profile
#22D	Pin	L	8599-0720 900	
	Pin	L	8599-0750 900	-
	Pin	M	8599-8028 900	-
	Pin	C	8599-0730 900	
	Pin	S	8599-0796 900	
	Socket	L	8599-0721 900	
	Socket	C	8599-0731 900	
	Socket	S	8599-0797 900	
#20	Pin	M	8599-0658 JJ	-
	Socket	M	8599-0759 900	-
	Pin	C	8599-0724 900	
	Socket	C	8599-0725 900	
	Pin	L	8599-0771 900	-
	Socket	L	8599-0772 900	-
#16	Pin	C	8599-0726 900	-
	Pin	C	8599-07482A 900	
	Socket	C	8599-0727 900	
Coaxial #16	Pin	C	8599-1000 900	
#12	Pin	C	8599-7929 900	-
	Socket	C	8599-7932 900	-
	Socket	C	8599-7485A 900	-

S: Specific PC tail L: Long PC tail M: Medium PC tail C: Short PC tail

Common Section



Coaxial contacts #12

Designation	Part number
Coaxial socket solder #12	THA1-0151A
Coaxial pin solder #12	THA1-0152A
Coaxial pin crimp contact #12	THA1-0155A
Coaxial crimp contact #12	THA1-0156A

Solder cup



Contact size	Contact type	Part number
#22D	Pin	8599-0750 900
#16	Pin	8599-7482A 900
#12	Socket	8599-7485A 900

For other contacts type please consult us.

Crimp contacts: 1500 mating

Contact size	MIL-DTL-38999 contacts		
	Contact type	Part number	Color code
#22D	Pin (H)	M39029/107 620	Blue / Red / Black
	Socket (J)	M39029/106 614	Blue / Brown / Yellow
#20	Pin (H)	M39029/107 621	Blue / Red / Brown
	Socket (J)	M39029/106 615	Blue / Brown / Green
#16	Pin (H)	M39029/107 622	Blue / Red / Red
	Socket (J)	M39029/106 616	Blue / Brown / Blue
#12	Pin (H)	M39029/107 623	Blue / Red / Orange
	Socket (J)	M39029/106 617	Blue / Brown / Gray

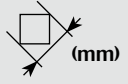
Wire wrap contacts

Contact size	Contact type	Part number	Contact Ø (mm)	Profile	 (mm)
#22D	Pin	8599-0790 JJ	0.76		0.86
#20	Pin	8599-0791 900	1		0.86









Quadrax #8 contacts

Contact type	Version	Souriau Part Number	Cross Norm	T°	Impedance	Sealing	Release
Pin	PCB mount	ETH1-1237A	-	125°C	100Ω	Sealed	Rear
		ETH1-1501A	-		150Ω		
	Crimp	ETH1-1345A	EN3155-074	200°C	100Ω		
		ETH1-1503A	-		150Ω		
Socket	PCB mount	ETH1-1238A	-	125°C	100Ω		
		ETH1-1502A	-		150Ω		
	Crimp	ETH1-1346A	EN3155-075	200°C	100Ω		
		ETH1-1504A	-		150Ω		

Common Section



Thermocouple contacts

Contact size	Contact type	Souriau part numbers (without color code)	MIL-DTL-38999 contacts		Ø Contact (mm)	Wire section				Ø Over insulation (mm)								
			Part numbers	Profile and color code		Awg		mm ²		min	max							
						min	max	min	max									
#22D Chromel	Pin	-	M39029/87-472	 Red / Violet / Yellow	0.75	28	22	0.095	0.34	0.76	1.37							
	Socket	-	M39029/88-484	 Yellow / Grey / Yellow														
#22D Alumel	Pin	-	M39029/87-471	 Brown / Violet / Yellow														
	Socket	-	M39029/88-483	 Orange / Grey / Yellow														
#20 Chromel	Pin	8599-0749 900	8599-0949 900	 Blue / Violet / Yellow								1	24	20	0.21	0.6	1.02	2.11
	Socket	8599-0753 900	8599-0953 900	 Grey / Grey / Yellow														
#20 Alumel	Pin	8599-0761 900	8599-0961 900	 Green / Violet / Yellow														
	Socket	8599-0765 900	8599-0965 900	 Violet / Grey / Yellow														

Dummy contacts

Size	Part number
#16	8599-6A016001A
#8	8599-0308
#4	8599-0310

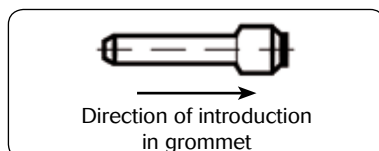

Filler plugs

Contact size	Filler plugs		
	MS Part number (Rev. N)	Color	Souriau Part number
#22D	MS27488-22-2	Black	8660-212
#20	MS27488-20-2	Red	8522-389A
#16	MS27488-16-2	Blue	8522-390A
#12	MS27488-12-2	Yellow	8522-391A
#10	-	-	-
#8	-	-	-
#4	-	-	-

Common Section



Insertion & extraction tools

Contact size	Material	Part number		Color	
		MIL standard	Souriau	Insertion	Extraction
#22D	Plastic	M81969/14-01	-	Green	White
#20	Plastic	M81969/14-10	-	Red	Orange
#16	Plastic	M81969/14-03	-	Blue	White
#12	Plastic	M81969/14-04	-	Yellow	White
#10	Plastic	M81969/14-05	-	Grey	-
#8	Plastic	M81969/14-12	-	-	Red
	Metalic	-	8660-197	-	-
#4	Plastic	M81969/14-07	-	-	Blue
	Metalic	-	8533-8175	-	-

Crimping tools

Contact size	Contact type	Plier M22520/1-01		Plier M22520/2-01 (Souriau 8476-01)		Plier M300BT	Plier * M22520/23-01	
		Turret Part number		Locator Part number		Locator Part number	Turret Part number	Locator Part number
		Norm	Souriau	Norm	Souriau			
#22D	Pin	-	-	M22520/2-09	8476-09	-	-	-
	Socket	-	-	M22520/2-07	8476-07	-	-	-
#20	Pin	M22520/1-04	8365-04	M22520/2-10	8476-10	-	-	-
	Socket					-	-	-
#16	Pin	M22520/1-04	8365-04	-	-	-	-	-
	Socket			-	-	-	-	
#12	Pin	M22520/1-04	8365-04	-	-	-	-	-
	Socket			-	-	-	-	
#8 Power	Pin	-	-	-	-	SP 593	M22520/23-02	8599-9601
	Socket	-	-	-	-			
#4 Power	pin	-	-	-	-	-	M22520/23-04	M22520/23-11
	Socket	-	-	-	-	-		

Contact size	Contact type	Plier M22520/2-01 (Souriau 8476-01)	Plier M22520/31-01	Plier M22520/4-01	Plier M22520/5-01
		Locator Part Number	Locator Part number	Locator Part Number	Die set Part Number
#12 Coaxial M39029/102-558 M39029/103-559	Inner	-	-	-	M22520/5-03
	Outer	-	-	-	
#12 Coaxial M39029/28-211 M39029/75-416	Inner	M22520/2-34	-	-	-
	Outer	-	M22520/31-02	-	-
#16 Coaxial	Inner	M22520/2-35	-	-	-
	Outer	-	-	M22520/4-02	-
#8 Coaxial	Inner	M22520/2-31	-	-	-
	Outer	-	-	-	M22520/5-05 closure B
#8 Triaxial	Inner	K709	-	-	-
	Middle	-	-	-	Y631 closure B
	Ferrule	-	-	-	Y631 closure A

* Pneumatic plier

Note: for the #10 contact's plier and locator, please consult us.

Common Section



Wiring instruction

Cable preparation and wire stripping

Contact size	#22D	#20	#16	#12	#8	#4
L min	3.58 .14	5.31 .21	5.31 .21	5.31 .21	12.5 .49	12.5 .49
L max	3.99 .16	5.82 .23	5.82 .23	5.82 .23	13 .51	13 .51

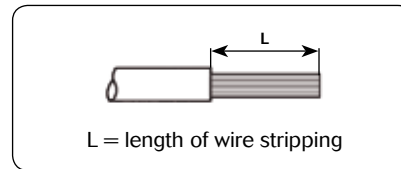

Insertion of wire in contact barrel

When inserting the stripped wire into the contact barrel check that no strands are left outside and that the wire is visible through the wire inspection hole in the barrel.

Important :

- Slide any accessories over wire strands before carrying out the following operations.
- Contacts are inserted and extracted from the rear of the connector.

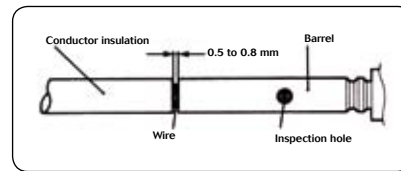

Insertion of the contacts

1 - Engage the crimp cable / contact assembly into the longitudinal slot of the plastic tool (coloured tip). Slide the tool down the cable until the tip of the tool abuts the contact retention shoulder.

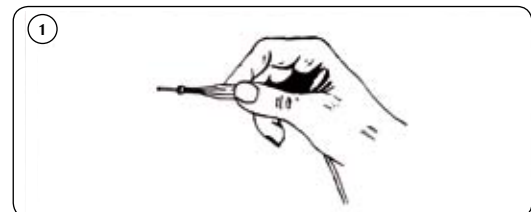

2 - Introduce the contact into the required contact cavity in the insulator, pushing tool axially, until the contact snaps into position in clip.

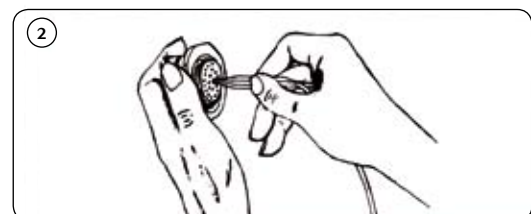

3 - Withdraw the tool (from rear). Check that contact is firmly locked by pulling wire gently. When connector is fully loaded, check the position of contact tips. They should all be in the same plane.



Nota : For larger sizes of cable which are stiff enough manual insertion without tool is preferable.



Wiring instruction

Extraction of the contacts

1 - Engage the appropriate cable into the longitudinal slot of the tool with the white tip towards connector.

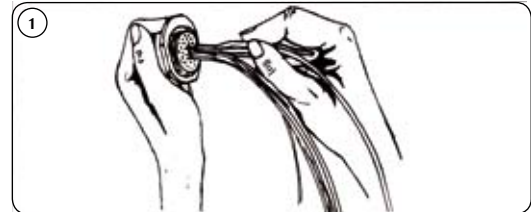

2 - Slide the tool down towards the contact. Insert the tool in the insulator until it abuts the contact shoulder.



3 - Holding the tool-contact and cable assembly together, remove them simultaneously.

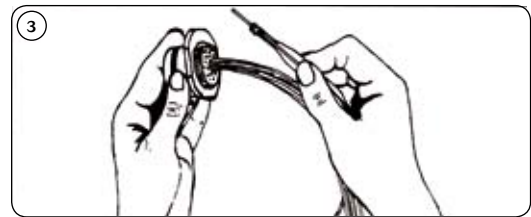

Backshell tightening and slackening tools

Backshell tightening pliers, part number : 8498-03

Square jaws, part number : 8500-1015 (order 2 jaws)

Strap clamp : 8498-04

Spare strap : 8498-103

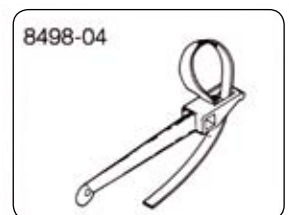
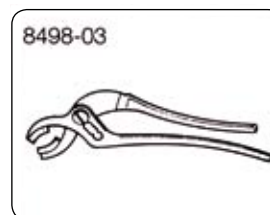

Tightening support

Part number: 8599-0831

This tool is made up of dummy receptable housings of all 9 sizes for all key polarisation, and locates free connectors during wiring and fitting of rear accessories.

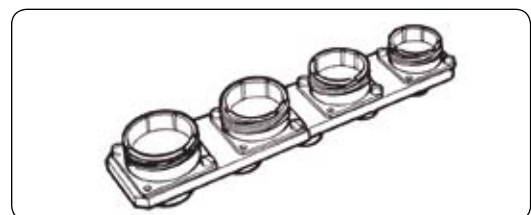

Common Section



Gaskets

Shell size	Gasket for receptacles Type 0* (ordered separately)	O ring for receptacle Type 7
9 (A)	8599-5541	AS3582-019
11 (B)	8599-5542	AS3582-022
13 (C)	8599-5543	AS3582-024
15 (D)	8599-5544	AS3582-026
17 (E)	8599-5545	AS3582-028
19 (F)	8599-5546	AS3582-128
21 (G)	8599-5547	AS3582-130
23 (H)	8599-5548	AS3582-132
25 (J)	8599-5549	AS3582-134

*For front mounting

Plastic protective caps*

Shell size	Caps for receptacles	Caps for plugs	Caps for composite plugs only (J & M)	Antistatic caps for receptacles	Antistatic caps for plugs
9 (A)	70777	8500-5587 A	MS90376-12R	70777N	8500-5587N
11 (B)	MS90376-12R	70198	8500-5598	MS9037612RF	8500-5588N
13 (C)	MS90376-14R	8500-5600	8500-5600	MS9037614RF	8500-5600N
15 (D)	MS90376-16R	8500-5601	8500-5601	MS9037616RF	8500-5601N
17 (E)	70201	8500-5602	8500-5602	70201N	8500-5602N
19 (F)	70209	8500-5592 A	8500-5592 A	8500-5590N	8500-5592N
21 (G)	MS90376-22R	8500-5593 A	8500-5593 A	8500-5591N	8500-5593N
23 (H)	MS90376-24R	8500-5593 A	70472	8500-5592N	8500-5591N
25 (J)	8500-5593 A	J599ABC6009A00	J599ABC6009A00	8500-5593N	8500-5592N

*Excepted 8D composite version (X): supplied without cap

8D - Reinforced Sealing Series



Reinforced Sealing Series

Derived from MIL-DTL-38999 Series III

8D - Reinforced Sealing Series



Description

- Reinforced sealing receptacle with male or female straight PC tail contacts
- High hermeticity performance: 10⁻⁷ atm.cm³/s
- 100 % scoop proof
- High density connectors
- Lower profile for compactness
- Weight saving compared to hermetic version
- Reinforced sealing for harsh environments
- Good shock resistance

Applications

- Avionics
- Missile warning systems
- To be used when enhanced sealing is needed in harsh environments
- To be used as an alternative to hermetic glass bead

Layouts

All 8D layouts can be manufactured with resin sealed (except for power contact - please consult us).

Ordering information

After the basic Series "8D", related to the digit "R" (8D+R...)
Don't forget the digit related to the PC tail length (C, M, L, S).

Examples:

8D (Alu) = 8DR 0 C 13 W 35 PN
8D (Titane) = 8DR 7 L 13 TT 35 PN

Comparison between standard, reinforced sealing and hermetic version

Example: 8D Series

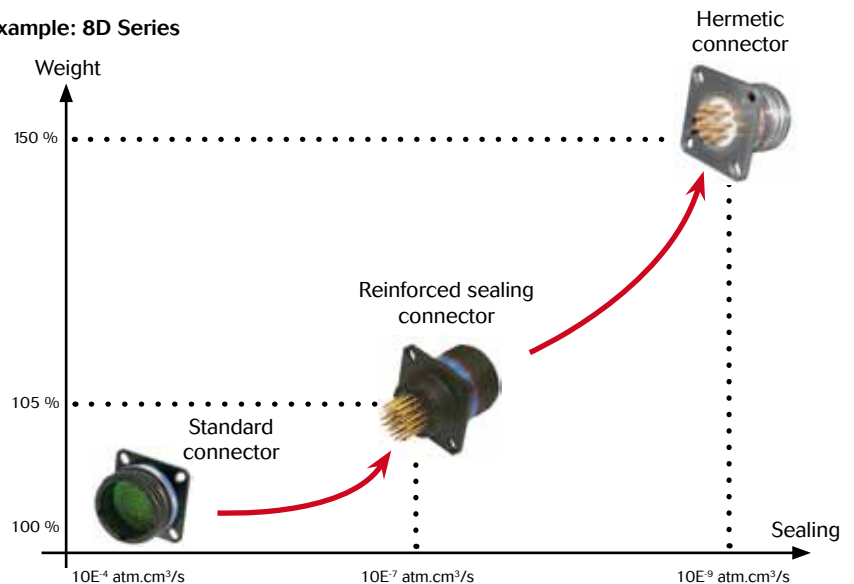

Please, consult us !



Hermetic Series

Derived from MIL-DTL-38999 Series III

8D - Hermetic Series



Description

As per MIL-DTL-38999

- Inert glass insulator
- High hermeticity performance
- Ideal for high pressure environments
- Low profile
- Nickel plating upon request

Technical features

Mechanical

- **Shell:** stainless steel
- **Shell plating:** passivated
- **Interfacial seal:** silicone elastomer
- **Contacts:** gold
- **Endurance:** 500 operations
- **Hermeticity:**
no leakage in excess of 10⁻⁷ cm³/s

Electrical

- **Test voltage rating:**

Service	sea level	at 21000 m
M	1 300	800
I	1 800	1 000
II	2 300	1 000

- **Shielding:** 45 dB at 10 GHz

- **Insulation resistance:**
5000 mh (under 500 Vdc)

- **Current rating:**

Contacts size	22D	20	16	12
Rating (A)	3	5	10	17

Environmental

- **Temperature:** -65°C at 200°C
- **Salt spray:** per MIL-DTL-38999

8D - Hermetic Series



Connector part numbers

Basic Series	F389999	21	y	A	35	P	N	WF	-
Shell style:									
21: Box mounting flange receptacle									
23: Jam nut receptacle									
25: Solder mounting receptacle									
Class:									
y: Passivated stainless steel									
Shell size:									
09=A, 11=B, 13=C, 15=D, 17=E, 19=F, 21=G, 23=H, 25=J									
Contact layout:									
See pages 11 to 14									
Contact type:									
P: Male solder cup									
C: Male straight PC tail (please consult us)									
Orientation:									
N, A, B, C, D, E (see page 65)									
Suffix:									
WF: Mandatory suffix									
Specification:									
None for standard product									

Dimensions

Box mounting flange receptacle (type 21)

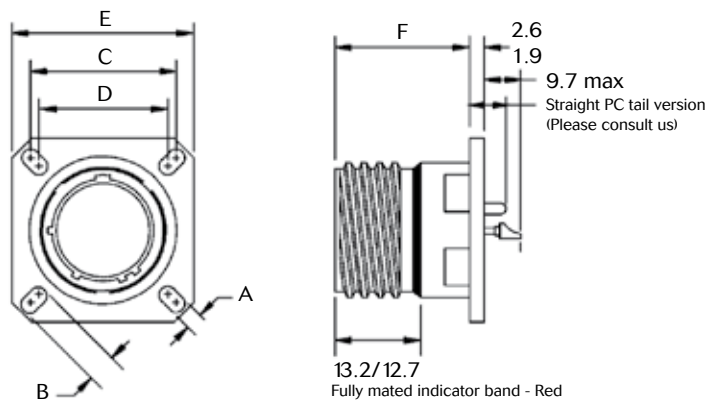

Shell size	A ± 0.20	B ± 0.20	C	D	E ± 0.30	F max
A (9)	3.25	4.93	18.26	15.09	23.80	21.40
B (11)			20.62	18.26	26.20	
C (13)			23.01	20.62	28.60	
D (15)			24.61	23.01	31.00	
E (17)			26.97	24.61	33.30	
F (19)			29.36	26.97	36.50	
G (21)			31.75	29.36	39.70	
H (23)	3.91	6.15	34.93	31.75	42.90	
j (25)			38.10	34.93	46.00	

Note: All dimensions are in millimeters (mm)

8D - Hermetic Series



Jam nut receptacle (type 23)

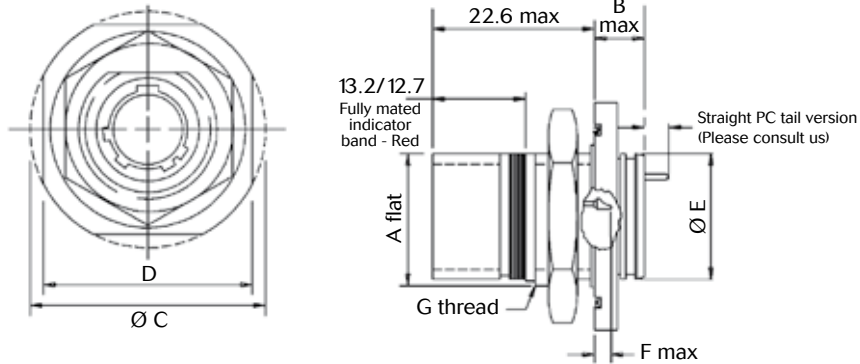

Shell size	A flat $\pm 0.10 / 0.15$	B max	$\text{Ø C} \pm 0.30$	$\text{Ø D} \pm 0.40$	$\text{Ø E} \pm 0.30/0$	F max	G thread
A (9)	16.53	9.10	30.20	27.00	16.30	5.30	M17 x 1-6g
B (11)	19.07		34.90	31.80	19.40		M20 x 1-6g
C (13)	23.82		38.10	34.90	22.70		M25 x 1-6g
D (15)	26.97		41.30	38.10	25.90		M28 x 1-6g
E (17)	30.15		44.50	41.30	29.00		M32 x 1-6g
F (19)	33.32	9.70	49.20	46.00	32.20	5.10	M35 x 1-6g
G (21)	36.50		52.40	49.20	35.40		M38 x 1-6g
H (23)	39.67		55.60	52.40	38.60		M41 x 1-6g
j (25)	42.85		58.70	55.60	41.70		M44 x 1-

Solder mounting receptacle (type 25)

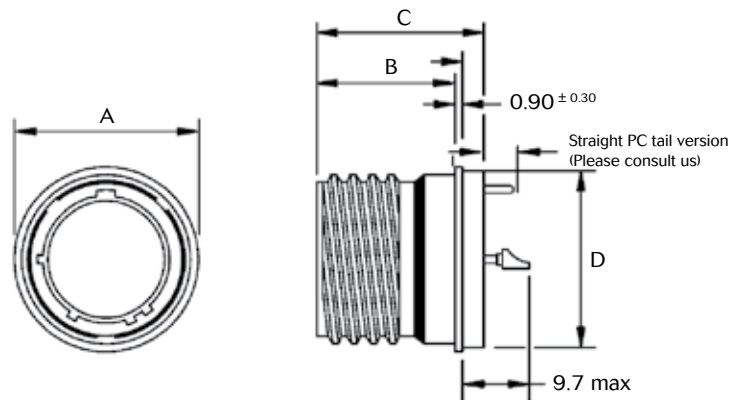

Shell size	Ø A max	B max	C max	D max
A (9)	19.40	17.20	23.80	17.10
B (11)	21.80			19.90
C (13)	24.90			23.10
D (15)	28.10			26.20
E (17)	31.30			29.40
F (19)	33.60			31.80
G (21)	36.80			35.00
H (23)	40.00	24.60	38.20	
j (25)	43.20		41.30	

Note: All dimensions are in millimeters (mm)



Clinch Nuts

Derived from MIL-DTL-38999 Series III

8D - Clinch Nuts



Description

- Square flange receptacle with 4 clinch nuts
- Clinch nut are selflocking
- Rear mounting
- Easy to install
- Time saving
- Different plating available over aluminum material
- Equivalent MIL level qualification as 38999 Series III
- Clinch nut tested:
 - Impact test (drop 0.4kg from height of 100mm)
 - Push out test (130N during 15s max)
 - Wrench out test (1N/m)
- Clinch Nut in UNC thread available on request

Technical features

Mechanical

- **Shell:** Aluminum
 - **Shells plating:**
 - Cadmium olive drab (W)
 - Nickel (F)
 - Black zinc nickel (Z)
 - Green zinc cobalt (ZC)
 - **Insulator:** Thermoplastic
 - **Grommet and interfacial seal:** Silicone elastomer
 - **Contact:** Copper alloy
 - **Contact plating:** Gold over nickel plated
 - **Endurance:**
 - . 500 mating/unmating operations
 - **Shock:**
 - 300g, 3 ms according EN 2591-D2 method A
 - **Vibration:**
 - . Sinus:
 - . 10 à 2000 Hz, 3x12 hrs
 - (60g, 140 - 2000 Hz) with T° cycling
 - . Random:
 - . 50 to 2000 Hz, 2x8 Hrs
 - (1g2/ Hz, 100 - 2000Hz) at T° max.
 - . 25 to 2000 Hz, 2x8 Hrs
 - (5g2/ Hz, 100 - 300Hz) at ambient T°
- Test with accessories in acc with EN 2591-D3

Contact retention:

Contact size	22	20	16	12	8	4
Min force in N	44	67	111	111	111	200

Electrical

Test voltage rating (Vrms)

Service	sea level	at 21000 m
M	1 300	800
N	1 000	600
I	1 800	1 000
II	2 300	1 000

Contact resistance

Contact size	22	20	16	12	8	4
Resistance mΩ	14.6	7.3	3.8	3.5	3	2

Insulation resistance:

≥ 5 000 MΩ (under 500 Vdc)

Contact rating:

Contact size	22	20	16	12	8	4
Rating (A)	5	7.5	13	23	45	80

Shell continuity

Cadmium olive drab (W): 2.5 Ωh
 Nickel (F): 1 Ωh
 Black zinc nickel (Z): 2.5 Ωh
 Green zinc cobalt (ZC): 2.5 Ωh

Shielding:

F: 65 db at 10 GHz
 F: 85 db at 1 GHz
 W: 50 db at 10 GHz
 Z & ZC: Consult us

Climatics

Temperature range:

W: -65°C +175°C F: -65°C +200°C
 Z: -65°C +200°C ZC: -65°C +200°C

Sealing:

Mated connectors meet altitude immersion requirements of MIL-DTL-38999.

Salt spray:

W: 500 Hrs F: 48 Hrs
 Z: 500 Hrs ZC: 500 Hrs

Resistance to fluids

According to MIL-DTL-38999 standard

- . Gasoline: JP5 (OTAN F44)
- . Mineral hydrolic fluid: MIL-H-5606 (OTAN H515)
- . Synthetic hydraulic fluid: Skydrol 500 B4

LD4 (SAE AS 1241)

- . Mineral lubricating: MIL-L-7870A (OTAN O142)
- . Synthetic lubricating: MIL-L-23699 (OTAN O156), MIL-L-7808
- . Cleaning fluid: MIL-DTL-25769 diluted
- . De-icing fluid: MIL-A-8243
- . Extinguishing fluid: Chlorobrométhane
- . Cooling fluid: Coolanol

8D - Clinch Nuts



Ordering information

Basic Series	8D	34	C	19	F	35	S	N
Shell style: 34: Square flange receptacle with M3 clinch nuts								
Contact length: (consult us) C: Short PC tail L: Long PC tail S: Specific PC tail								
Shell size: 09, 11, 13, 15, 17, 19, 21, 23, 25								
Plating: F: Nickel W: Olive green cadmium Z: Black zinc nickel ZC: Green zinc cobalt								
Contact layout: See pages 11 to 14								
Contact type: P: Pin S: Socket								
Orientation: N, A, B, C, D, E								

Dimensions

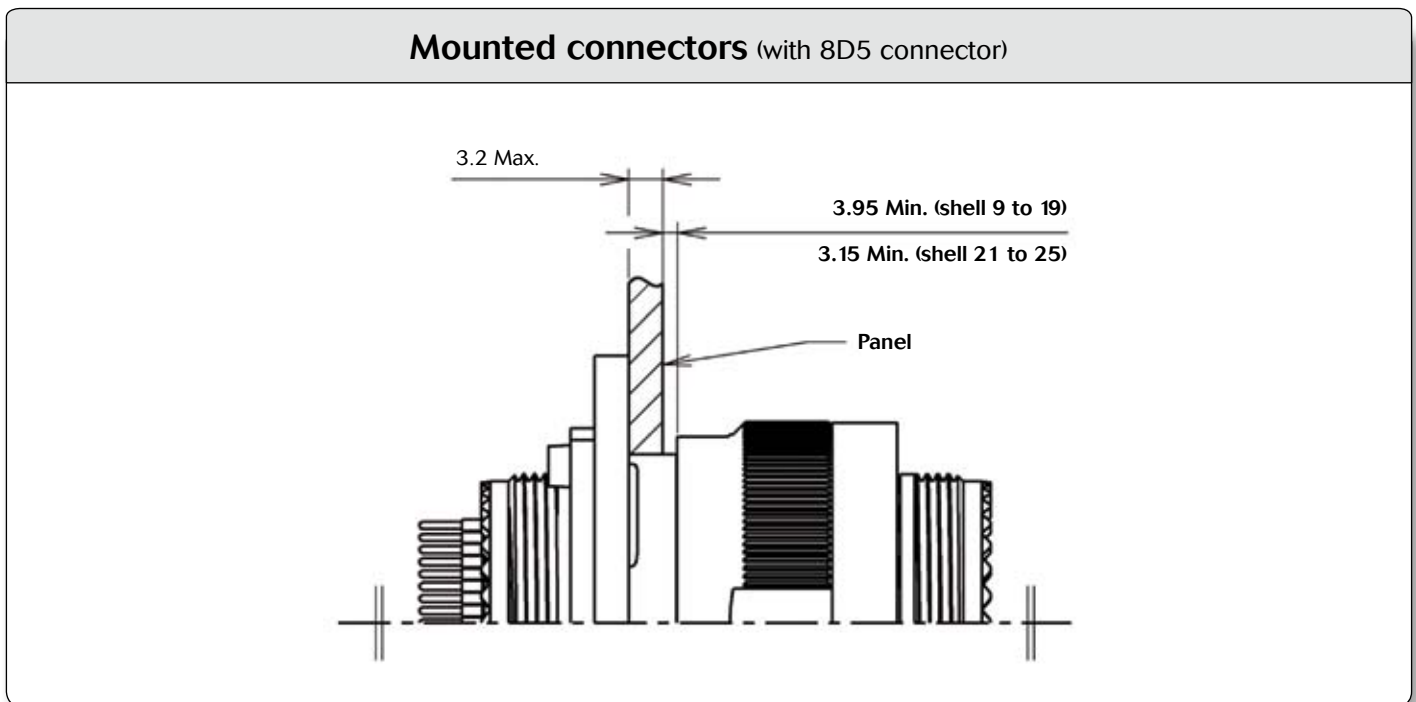

Note: All dimensions are in millimeters (mm)

8D - Clinch Nuts



Jam nut receptacle (type 34)

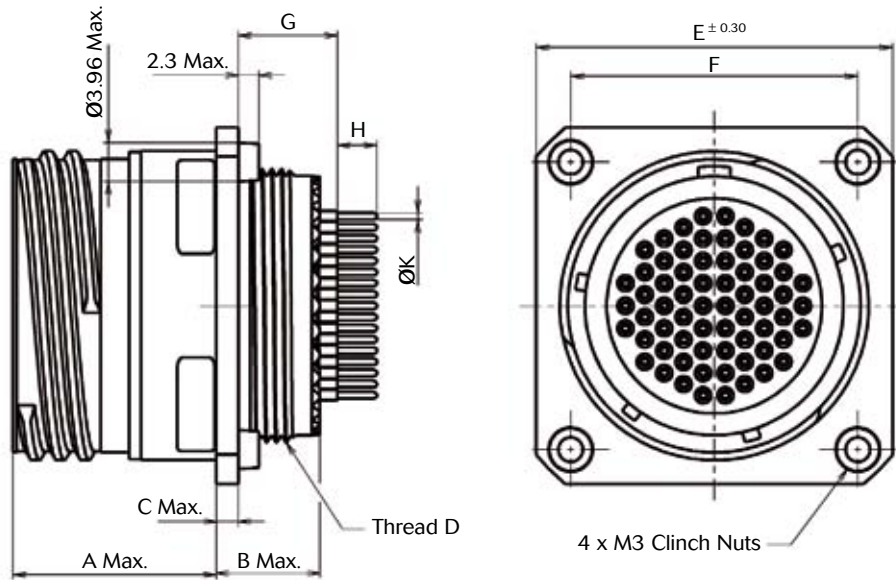

Shell Size	A Max	B Max	C Max	D Thread	E ±0.3	F
9	20.90	10.60	2.50	M12x1-6g	27.79	18.26
11				M15x1-6g	30.15	20.62
13				M18x1-6g	32.54	23.01
15				M22x1-6g	34.14	24.61
17				M25x1-6g	36.5	26.97
19				M28x1-6g	38.89	29.36
21	20.10	11.40	3.20	M31x1-6g	41.27	31.75
23				M34x1-6g	44.45	34.93
25				M37x1-6g	47.62	38.1

Short contact length

For other length please consult us

Shell size	G				H		K	
	#22D		#20 & #16		#22D	#20 & #16	#22D & #20	#16
	P	S	P	S	P & S	P & S	P & S	P & S
9	9.47 / 10.54	9.09 / 10.54	9.64 / 10.71	9.26 / 10.71	3.8 / 4.0	4.9 / 5.1	0.65 / 0.70	1.09 / 1.15
11								
13								
15								
17								
19								
21	9.58 / 10.65	9.20 / 10.65	9.75 / 10.82	9.37 / 10.82				
23								
25								

Note: All dimensions are in millimeters (mm)

8D - Double Flange



Double Flange

Derived from MIL-DTL-38999 Series III

8D - Double Flange



Description

- High level vibration resistance in harsh environments.
- Offers the same level of performance as the MIL-DTL-38999 Series III connector.
- New receptacle body: Square flange & Jam Nut.
- No risk of breaking contacts.
- No risk of micro-cuts.
- Allow direct grounding from PCB to the flange.
- Standard PC tails contacts: #16, #20 and #22 - as well as specific ones.

Technical features

Mechanical

- **Shell:** Aluminum
 - **Shell plating:**
 - . Cadmium olive drab (W)
 - . Nickel (F)
 - . Black zinc nickel (Z)
 - **Insulator:** Thermoplastic
 - **Grommet and interfacial seal:** Silicone elastomer
 - **Contacts:** Copper alloy
 - **Contacts plating:** Gold over nickel plated
 - **Endurance:** 500 mating/unmating operations whatever the material used
 - **Shock:** 300g, 3 ms according EN 2591-D2 method A
 - **Vibration:**
 - . Sinus:
 - . 10 à 2000 Hz, 3x12 hrs (60g, 140 - 2000 Hz) with T° cycling
 - . Random:
 - . 50 to 2000 Hz, 2x8 Hrs (1g2/ Hz, 100 - 2000Hz) at T° max.
 - . 25 to 2000 Hz, 2x8 Hrs (5g2/ Hz, 100 - 300Hz) at ambient T°
- Test with accessories in acc with EN 2591-D3

Contact retention:

Contact size	22	20	16	12	8	4
Min force in N	44	67	111	111	111	200

Electrical

Test voltage rating (Vrms)

Service	sea level	at 2 1000 m
M	1 300	800
N	1 000	600
I	1 800	1 000
II	2 300	1 000

Contact resistance

Contact size	22	20	16	12	8	4
Resistance mΩ	14.6	7.3	3.8	3.5	3	2

Insulation resistance:

≥ 5 000 MΩ (under 500 Vdc)

Contact rating:

Contact size	22	20	16	12	8	4
Rating (A)	5	7.5	13	23	45	80

Shell continuity:

- . Cadmium olive drab (W): 2.5 Ωh
- . Nickel (F): 1 Ωh
- . Black zinc nickel (Z): 2.5 Ωh

Shielding:

- . F: 65 db at 10 GHz; 85 db at 1 GHz
- . W: 50 db at 10 GHz
- . Z: Consult us

Climatics

Temperature range:

- . W: -65°C +175°C
- . F: -65°C +200°C
- . Z: -65°C +200°C

Sealing:

Mated connectors meet altitude immersion requirements of MIL-DTL-38999.

Salt spray:

- . W: 500 Hrs
- . F: 48 Hrs
- . Z: 500 Hrs

Resistance to fluids

According to MIL-DTL-38999 standard

- . Gasoline: JP5 (OTAN F44)
- . Mineral hydrolic fluid: MIL-H-5606 (OTAN H515)
- . Synthetic hydraulic fluid: Skydrol 500 B4

LD4 (SAE AS 1241)

- . Mineral lubricating: MIL-L-7870A (OTAN 0142)
- . Synthetic lubricating: MIL-L-23699 (OTAN 0156), MIL-L-7808
- . Cleaning fluid: MIL-DTL-25769 diluted
- . De-icing fluid: MIL-A-8243
- . Extinguishing fluid: Chlorobromethane
- . Cooling fluid: Coolanol

8D - Double Flange



Comparison

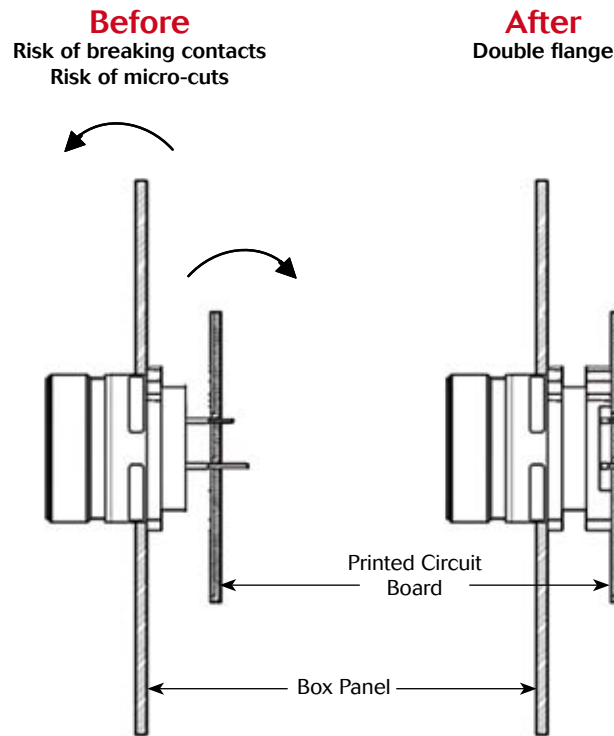

Ordering information

Basic Series	8D	87	11	C	17	W	35	P	N	-
Shell type:										
87: Jam nut receptacle										
Length between panel & PCB *										
Type:										
C: Receptacle with short PC tail										
L: Receptacle with long PC tail										
Shell size:										
09, 11, 13, 15, 17, 19, 21, 23, 25										
Plating:										
W: Olive green cadmium										
F: Nickel (ROHS)										
Z: Zinc nickel										
Contact layout:										
See pages 11 to 14										
Contact type:										
P: Pin										
S: Socket										
Orientation:										
N, A, B, C, D, E										
Specification:										
None: Standard										
L: Without contacts										
For other specification, please contact us										

* For other length between panel & PCB please consult us.

8D - Double Flange



Dimensions

Jam nut receptacle (type 87) - Size 9 & 11

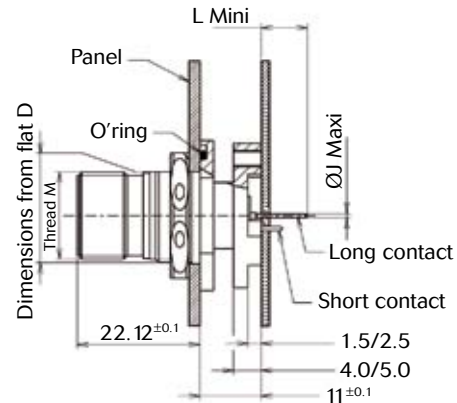
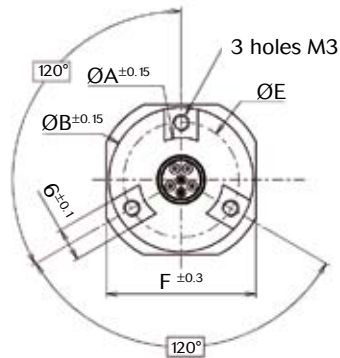

Shell size	$\text{ØA} \pm 0.15$	$\text{ØB} \pm 0.15$	D max.	ØE	$F \pm 0.3$	Thread M
9	15.10	26.00	16.56	20.50	27.01	5/8" UNEF-24
11	19.90	30.80	19.10	25.20	31.81	3/4" UNEF-20

Jam nut receptacle (type 87) - Size 13 to 25

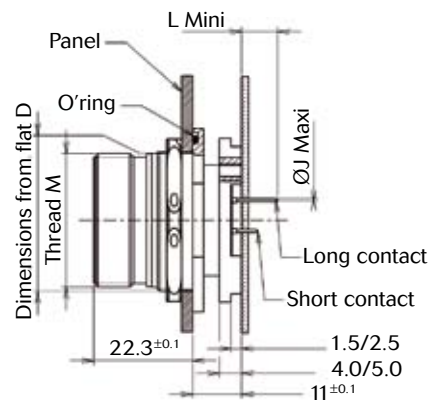
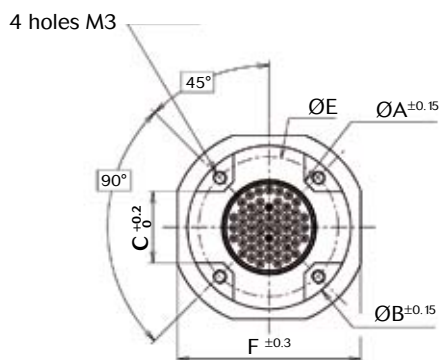

Shell size	$\text{ØA} \pm 0.15$	$\text{ØB} \pm 0.15$	$C_0^{+0.2}$	D max.	ØE	$F \pm 0.3$	Thread M
13	19.90	30.80	12	23.85	25.25	34.91	7/8" UNEF-20
15	23.00	33.90	14	27.00	28.42	38.11	1" UNEF-20
17	26.00	36.80	16	30.20	31.42	41.31	1"3/16 UNEF-18
19	29.50	40.40	18	33.35	35.03	46.01	1"1/4 UNEF-18
21	32.50	43.20	20	36.55	37.82	49.21	1"3/8 UNEF-18
23	35.50	46.50	23	39.70	41.12	52.41	1"1/2 UNEF-18
25	38.60	49.60	25	42.90	44.30	55.61	1"5/8 UNEF-18

Note: All dimensions are in millimeters (mm)

8D - Double Flange



Straight PC tail contacts

Contact size	Contact type	PC tail length	L min	ØJ max
22D	P	L	7.1	0.7
	S			
	P	C	3.6	
	S			
20	P	L	7.1	0.9
	S			
	P	C	3.6	
	S			
16	P	L	7.1	1.35
	S			
	P	C	3.6	
	S			
12	P	L	-	-
	S			
	P	C	3.6	1.7
	S			

Note: All dimensions are in millimeters (mm)



Optical ELIO® Contacts

Derived from MIL-DTL-38999 Series III

8D - Optical ELIO® Contacts



EN4531

ABS1379

Arinc801

ELIO® contact

- Robust spring-loaded butt-joint optical contact using ST style ferrule (diameter 2.5mm)
- Contact size equivalent to a #16 contact
- Anti-rotation of the contact for better vibration withstanding and optical performance
- Boot-grommet for rear sealing and protection of the cable against excessive bending
- Compatibility with loose and tight structure cables
- High level optical performance even after aging
- Bayonet locking system: no tool needed for mounting/dismounting
- Compatible with singlemode and multimode cable

Applications

- ELIO® fiber optic contacts apply wherever robustness, high performance and easy maintenance are needed:
 - Aerospace,
 - Military,
 - Marine,
 - Geophysics,
 - Railways...

Technical features

Mechanical

- **Endurance:**
Minimum 500 mating / unmating operations
- **Shock:**
300 g, 3 ms as per EN 2591-6402 method A
- **Vibration:**
In MIL-DTL-38999 Series III/EN3645 connectors:
 - Sine 5Hz to 3000Hz as per EN2591-6403 method A
 - Random as per EN2591-6403 method B
- **Cable cyclic flexing*:**
100 cycles, load 40N as per EN2591-609
- **Cable pulling*:** 111N
- **Cable torsion*:**
100 cycles, load 40N as per EN2591-611

Environmental

- **Salt spray:**
See the connector standard
- **Temperature range*:**
-65°C to +125°C (1000 hours)
- **Rapid temperature change:**
10 cycles -65°C / +150°C (30min/30min)
- **Air leakage:**
Max leakage 16 cm³/h, 2 hours, 40kPa differential pressure
- **Damp heat and low temperature:**
5 cycles of 48h -65°C/+70°C with stage at 40°C with 95% of humidity as per EN2591-6303 method A

Optical

- **Insertion Loss (IL)*:**
< 0.3dB over 95% of the samples as per EN2591-601,
< 0.7dB maximum on 100% of the samples after tests
- **Return Loss (RL)*:**
> 21dB before and after tests as per EN2591-605
- **Singlemode contact:** Please consult us

Resistance to fluids as per MIL-DTL-38999/EN3645 standard

- **Fuel:** JP5
- **Mineral Hydraulic fluid:**
MIL-PRF-5606 (NATO H-515)
- **Synthetic hydraulic fluid:**
AS1241 (Skydrol 500B4, LD4)
- **Mineral lubricant:**
MIL-PRF-7870 (NATO O-142)
- **Synthetic lubricant:**
MIL-PRF-23699 (NATO O-156),
MIL-PRF-7808 (NATO O-148)
- **Cleaning fluid:**
MIL-PRF-87937 diluted, Propanol, white spirit, Azeotrope R113 + Methanol
- **De-icing fluid:**
AMS 1424 (NATO S-742)
- **Extinguishing fluid:**
Chlorobromomethane
- **Cooling fluid:**
Coolanol

* With multimode EN4641-100 cable and following the cabling process described in the "Technical Bulletin N°204 - ELIO® assembly wiring instructions" and the maintenance procedure in the document "Technical Bulletin N°170 - Fiber optics installation and maintenance procedure"

8D - Optical ELIO® Contacts



Ordering information

	Elio	09	N	G	L	A
Cable external diameter:						
09: 0.9 mm or cable wider than 1.9mm with 0.9mm jacket inside						
18: from 1.5mm to 1.9mm						
Contact sealing:						
W: waterproof (1.8mm +/- 0.1mm cable only)						
N: non waterproof						
Fibre type:						
G: 50 or 62,5/125 µm						
D: 100/140 µm						
For singlemode fibre (9/125) please consult us.						
Boot type:						
L: Long boot						
S: Short boot						
N: No boot (non waterproof version only)						
Contact version index						

ELIO® contact dimensions

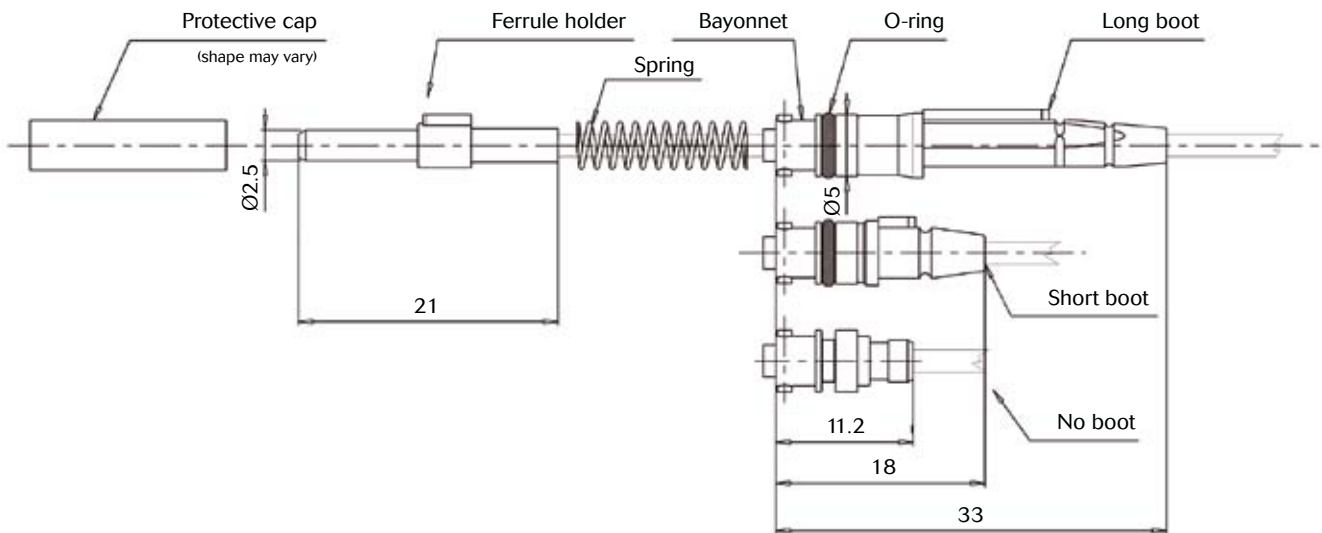

Note: All dimensions are in millimeters (mm)

8D - Optical ELIO® Contacts



Insertion & extraction tooling

Tool needed for short boot and no boot contacts versions.

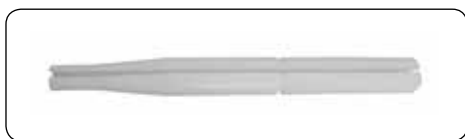

* For long boot, tool recommended for 8 way high density insert and more.

Recommended cables

SOURIAU can offer a wide range of cables in its assemblies, from low cost to high performance aeronautical cables.

ELIO® contact is compatible with singlemode and multimode cable, with tactical and breakout cable.

ELIO® contact is suitable with loose and tight structure cable.

See Souriau "ELIO® Fiber Optic Technology» catalog.

8D - Optical ELIO® Contacts



EN4531
ABS1213
Arinc801

MIL-DTL-38999 Series III/EN3645 with ELIO® high density insert

- Standard MIL-DTL-38999/EN3645 shells without shielding ring (aluminum, composite, stainless steel, bronze)
- Environmental performance as per EN4531 based on MIL-DTL-38999/EN3645
- Temperature range: - 65°C to + 125°C (cable limitation)

Ordering information

Composite, Aluminum & Stainless Steel

	8D	5	E	11	W	02	A	N
Shell type:								
5: Plug								
0: Receptacle with 4-hole square flange fixing								
7: Receptacle with single hole jam nut fixing (<i>aluminum & stainless steel only</i>)								
Designation:								
E: ELIO® optical connector								
Shell size:								
09, 11, 13, 19 (aluminum, composite & stainless steel)								
25 (aluminum & stainless steel only)								
Plating:								
Aluminum:								
Z: Zinc nickel								
ZC: Zinc cobalt								
W: Olive green cadmium								
F: Nickel								
Composite:								
J: Olive green cadmium								
M: Nickel								
X: Without plating								
Stainless steel:								
K: Passivated								
S: Nickel								
Contact layouts:								
See pages 11 to 14								
Insert type: *								
A: Male insert								
B: Female insert with ceramic alignment sleeves								
Orientation:								
N, A, B, C, D, E								

* Souriau advice: A for plug & B for receptacle

8D - Optical ELIO® Contacts



JVS Bronze

	JVS	E	6	A	11	02	A	N
Designation: E: ELIO® optical connector								
Shell type: 6: Plug 0: Receptacle with 4-hole square flange fixing 7: Receptacle with single hole jam nut fixing								
Material: A: Bronze								
Shell size: 09, 11, 13, 19, 25								
Contact layouts: See pages 11 to 14								
Insert type: * A: Male insert B: Female insert with ceramic alignment sleeves								
Orientation: N, A, B, C, D, E								

* Souriau advice: A for plug & B for receptacle

8D - Optical ELIO® Contacts



ELIO® AQ Adaptor for Quadrax #8 cavities

- ELIO® AQ is an adaptor to enable the ELIO® contact to fit in any #8 Quadrax cavities in several types of connectors. Therefore, any layout containing #8 cavities can be implemented with the ELIO® fiber optic contact
- Multiple possibilities to mix optical and electrical signals in the same insert
- Temperature range: -65°C to +125°C (cable limitation)
- 100% compliant with ELIO® contact optical performance
- Before use, please ask for "Technical Bulletin N°160 Mounting Instructions ELIO® AQ adaptor"

Ordering information

Male Insert	ELIO-AQ0P *		ARINC 404 (rear release) ARINC 600 (rear release)
	ELIO-AQ1P		ARINC 404 (front release) ARINC 600 (front release)
	ELIO-AQ4P		EN3646 EN3545
	ELIO-AQ6PA *		MIL-DTL-38999 Series III/ EN3645
Female Insert	ELIO-AQ0S		ARINC 404 (rear release) ARINC 600 (rear release) EN3646 EN3545
	ELIO-AQ6SA *		MIL-DTL-38999 Series III/ EN3645

* Delivered with alignment boot

8D - Optical ELIO® Contacts



MIL-DTL-38999 Series III/EN3645 with ELIO® AQ Adaptor for Quadrax #8 cavities

- Compatible with standard MIL-DTL-38999 Series III/EN3645 Souriau connectors (aluminum, composite, stainless steel, bronze)
- Design ensures ELIO® optical performance
- Environmental performance as per MIL-DTL-38999 and EN3645 standard
- Temperature range: - 65°C to +125°C (cable limitation)

Contact layouts

See pages 11 to 14

Ordering information

Aluminum: see page 18

Composite: see page 32

Stainless steel: see page 40

Bronze: see page 54

8D - Optical ELIO® Contacts



Dimensions

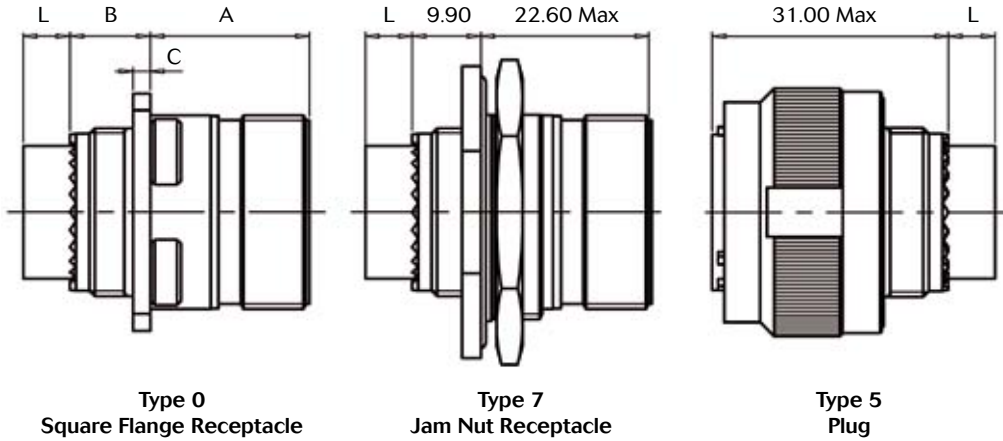

	A		B		C		L	
	Shell size 09 to 19	Shell size 25	Shell size 09 to 19	Shell size 25	Shell size 09 to 19	Shell size 25	Male insulator	Female insulator
Receptacle Type 0-7 Metal	20.90 Max	20.10 Max	10.60 Max	11.40 Max	2.50 Max	3.20 Max	4 Max	6.60 Max
Receptacle Type 0-7 Composite	20.90 Max	20.90 Max	10.60 Max	10.60 Max	2.50 Max	2.50 Max		

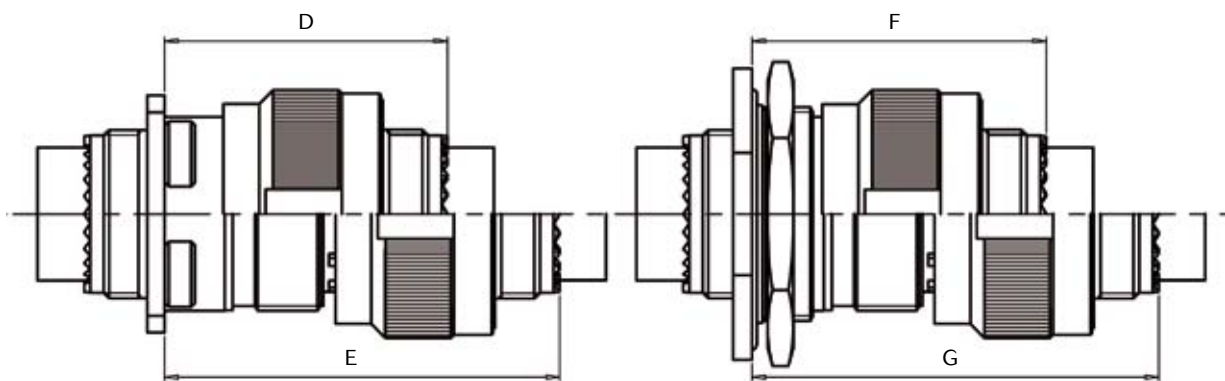

	D		E		F		G	
	Shell size 09 to 19	Shell size 25	Shell size 09 to 19	Shell size 25	Shell size 09 to 11	Shell size 13 to 25	Shell size 09 to 11	Shell size 13 to 25
Plug + Receptacle Type 0 - 7 Metal	37.00 Max	36.00 Max	52.30 Max	51.30 Max	38.30 Max	38.50 Max	53.60 Max	53.80 Max
Plug + Receptacle Type 0 Composite	37.00 Max	36.00 Max	52.30 Max	51.30 Max	N/A	N/A	N/A	N/A

Note: All dimensions are in millimeters (mm)

8D - Optical ELIO® Contacts



Dimensions

38999 Series III/EN3645 with ELIO® contacts in ELIO® high-density insert

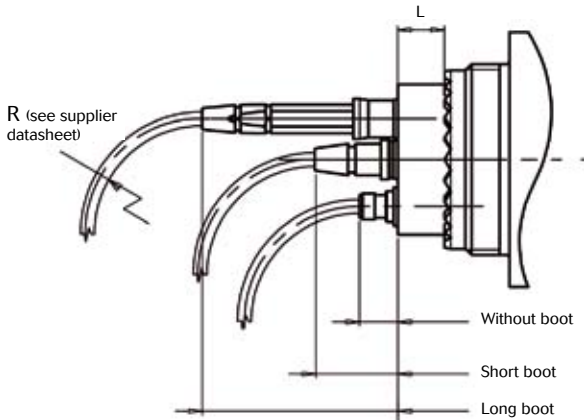

38999 Series III/EN3645 with ELIO® contacts in ELIO® AQ adaptors

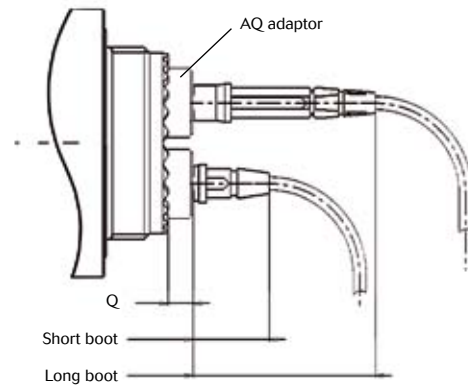

	ELIO® high density insert					ELIO® AQ adaptors			
	L		Contact length			Q		Contact length	
	Male insulator	Female insulator	Without boot	Short boot	Long boot	Male insulator	Female insulator	Short boot	Long boot
Plug									
Square flange receptacle	4 Max	6.60 Max	6 Max	12 Max	27 Max	9.60 Max	3 Max	12 Max	27 Max
Jam nut receptacle								11.50 Max	26.50 Max

Total length example

Square flange receptacle + plug + ELIO® contacts in ELIO® high-density insert

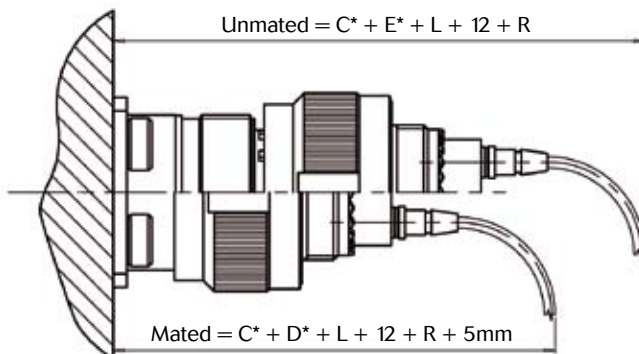

* See previous page

Note: All dimensions are in millimeters (mm)



RJ45/USB Series

Derived from MIL-DTL-38999 Series III

8D - RJ45-USB Series



Description

- Derived from MIL-DTL-38999 Series III
- True ruggedized RJ45 & USB A solution
- High vibration resistance
- Shock resistant
- IP67
- Shielded
- Available in feed through, solder out and pig tail version
- No tools for cabling
- RoHS version

Applications

- Data transmission using standard interface
- Flight data transmissions

Technical features

Mechanical

- **Shell material:**
 - Aluminum alloy
 - Composite
- **Shell plating:**
 - Olive drab cadmium
 - Nickel
 - Olive drab cadmium
 - Nickel
 - Black zinc nickel
 - Zinc cobalt

- **Insert:**
 - Thermoplastic
- **Contacts:**
 - Copper alloy
- **Contacts plating:**
 - Gold
- **Endurance:**
 - Per MIL-DTL-38999, 500 mating cycles
- **Vibration:**
 - 10-500 Hz 20 g

Electrical

- **RJ45:**
 - 10 BaseT, 100 BaseTX and 1000 BaseT
 - Cat 5e per TIA/EIA 568A/B
- **USB:**
 - 10 BaseT and 100 BaseTX
 - Cat 5e per TIA/EIA 568A/B

Climatic

- **Sealing:**
 - IP67 with protective cap
- **Temperature range:**
 - 40°C to +85°C
- **Fluid resistance:**
 - Per MIL-DTL-38999 with protective cap

8D - RJ45-USB Series



Connector part numbers

Basic Series	8D	0	F	17	W	UA	S	N	...
Shell type:									
0: Square flange receptacle									
7: Jam nut receptacle (aluminum only)									
5: EMI / RFI plug									
Designator:									
F: Feedthrough									
S: Solder out									
C: Pig tail cable receptacle									
P: Pig tail cable plug									
Shell size:									
17: USB									
19: RJ45									
Plating:									
W: Olive drab cadmium (aluminum) - 500 hours salt spray									
F: Nickel (aluminum) - 48 hours salt spray									
J: Olive drab cadmium (composite) - 500 hours salt spray									
M: Nickel (composite) - 500 hours salt spray									
Z: Black zinc nickel (aluminum) - 500 hours salt spray									
ZC: Zinc cobalt - 250 hours salt spray									
X: No finish (composite)									
Insert:									
UA: USB type A									
RJ: RJ45									
Contact style:									
S: Socket									
P: Plug									
Orientation:									
N, A, B, C, D, E									
Specification code:									
Consult us for custom configuration (cable type, length, termination style)									

8D RJ45 Series



Square flange receptacle

Jam nut receptacle

8D USB Series



Square flange receptacle

Jam nut receptacle

8D - RJ45-USB Series



RJ45 interface - Receptacle Feedthrough Series

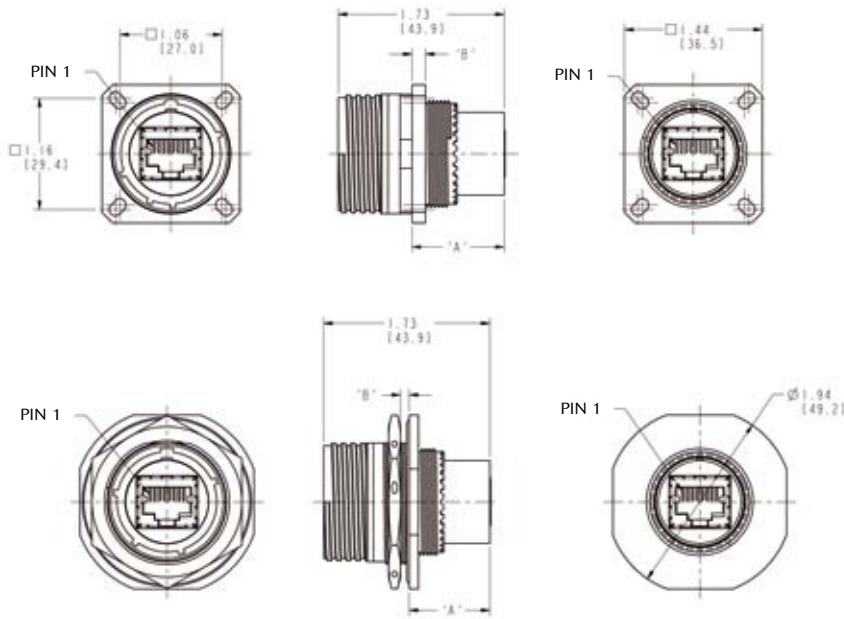

Jam nut (max)		
Shell type	A	B
Aluminum	0.809 / 20.55	0.098 / 2.50
Composite	0.818 / 20.78	0.144 / 3.65

Square flange (max)		
Shell type	A	B
Aluminum	0.840 / 21.34	0.126 / 3.20

RJ45 interface - Receptacle Solder Out Series

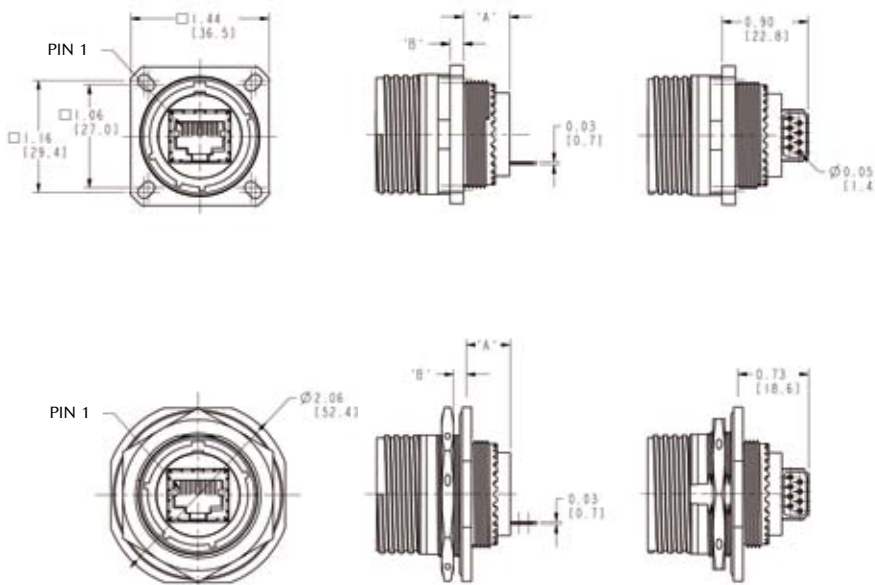

Square flange (max)		
Shell type	A	B
Aluminum	0.469 / 11.91	0.098 / 2.50
Composite	0.478 / 12.14	0.144 / 3.65

Jam nut (max)		
Shell type	A	B
Aluminum	0.500 / 12.70	0.126 / 3.20

8D - RJ45-USB Series



RJ45 interface - Receptacle Pigtail Series

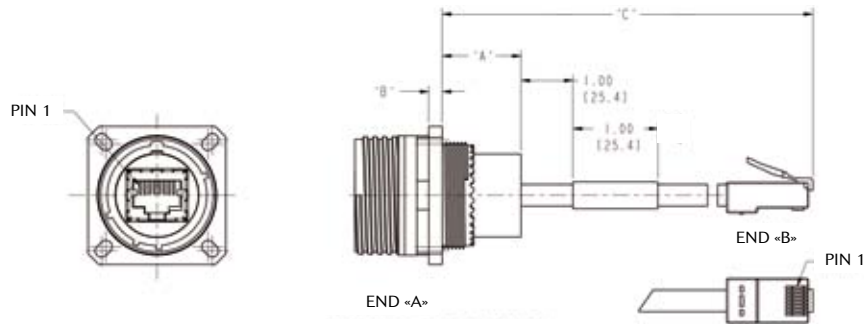

Square flange (max)			
Shell type	A	B	C
Aluminum	0.809 / 20.78	0.098 / 2.50	12.00 ± 1.00 / 304.8 ± 25.4
Composite	0.818 / 20.78	0.144 / 3.65	12.00 ± 1.00 / 304.8 ± 25.4

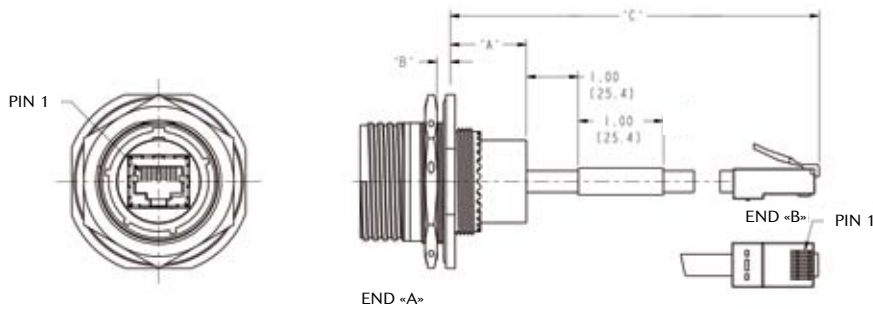

Jam nut (max)			
Shell type	A	B	C
Aluminum	0.840 / 21.34	0.126 / 3.20	12.00 ± 1.00 / 304.8 ± 25.4

RJ45 interface - Receptacle Panel Cut Out

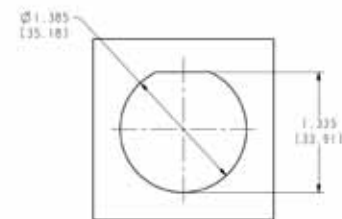
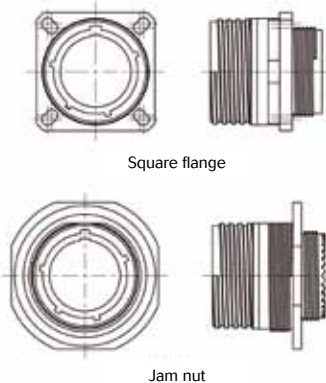

Maximum panel thickness for receptacle: 0.126"
Jam nut panel cut out

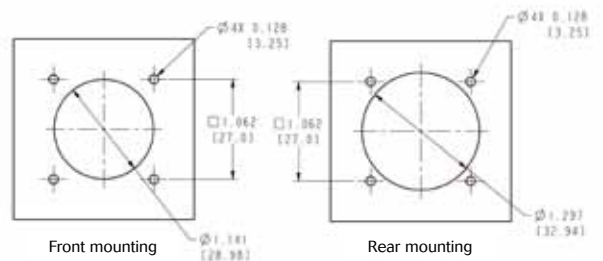

Maximum panel thickness for receptacle:
Front mounting: 0.126" max
Rear mounting: 0.098" max

Square flange panel cut out

8D - RJ45-USB Series



RJ45 interface - Plug

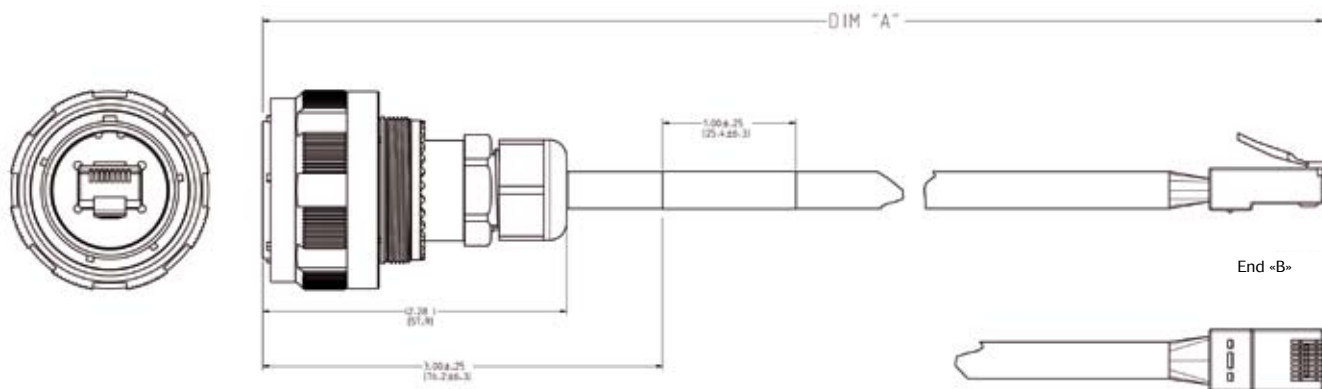

Dimensions: Inch / mm

8D - RJ45-USB Series



USB interface - Receptacle Feedthrough Series

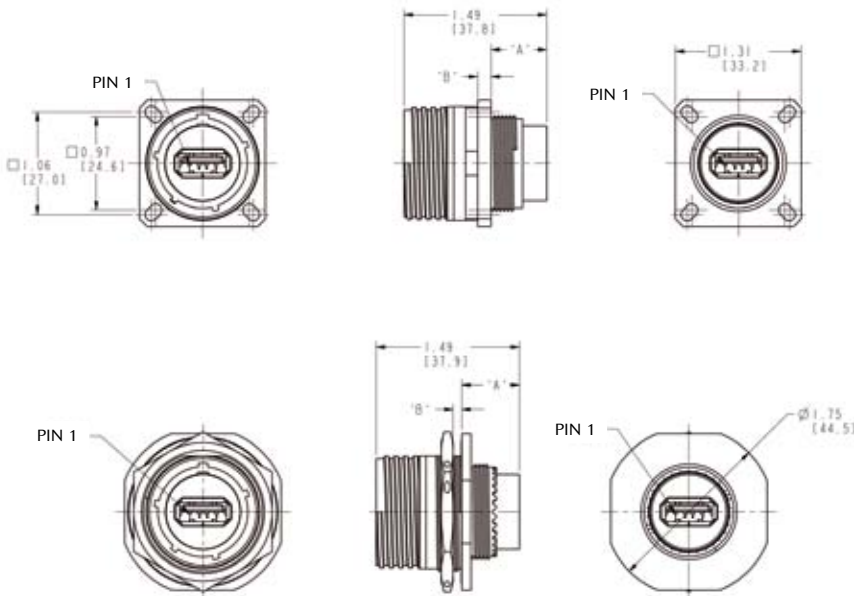

Jam nut (max)		
Shell type	A	B
Aluminum	0.569 / 14.45	0.098 / 2.50
Composite	0.578 / 14.68	0.144 / 3.65

Square flange (max)		
Shell type	A	B
Aluminum	0.600 / 15.24	0.126 / 3.20

USB interface - Receptacle Solder Out Series

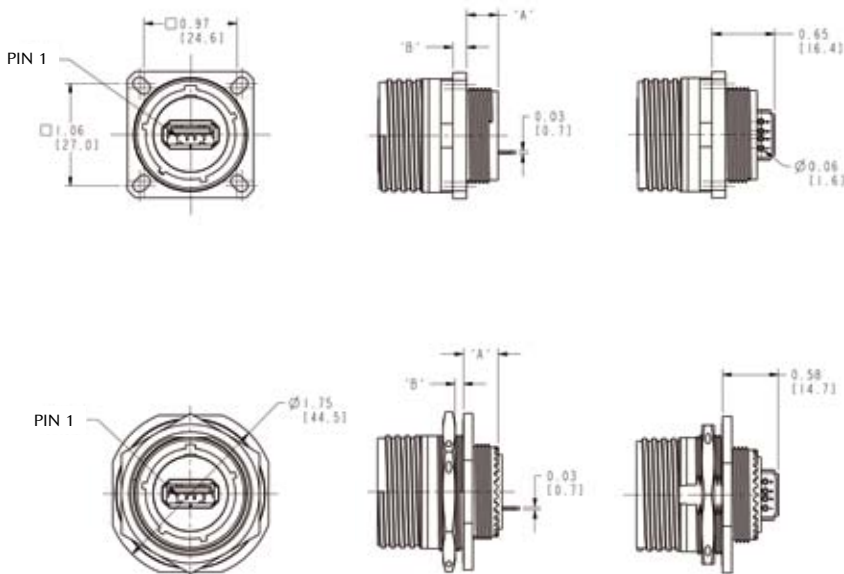

Square flange (max)		
Shell type	A	B
Aluminum	0.319 / 8.10	0.098 / 2.50
Composite	0.328 / 8.33	0.144 / 3.65

Jam nut (max)		
Shell type	A	B
Aluminum	0.470 / 11.94	0.126 / 3.20

8D - RJ45-USB Series



USB interface - Receptacle Pigtail Series

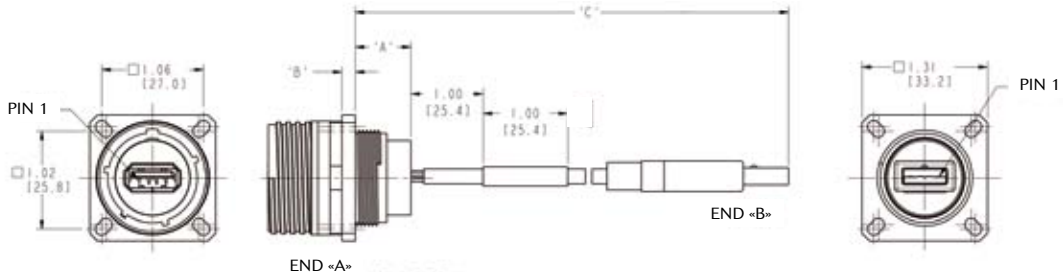

Square flange (max)			
Shell type	A	B	C
Aluminum	0.596 / 14.45	0.098 / 2.50	12.00 ± 1.00 / 304.8 ± 25.4
Composite	0.578 / 14.68	0.144 / 3.65	12.00 ± 1.00 / 304.8 ± 25.4

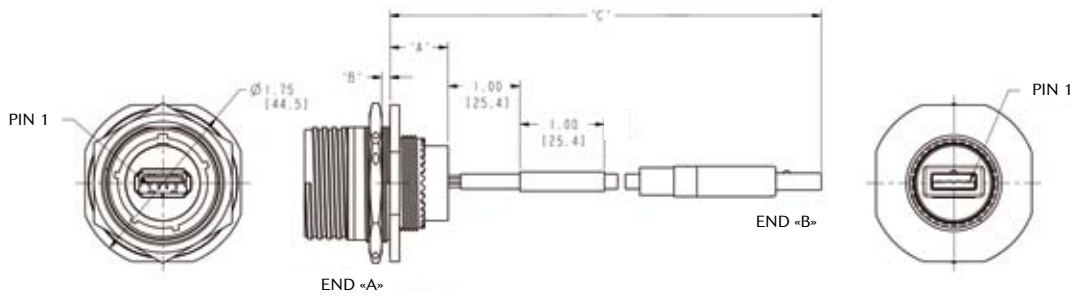

Jam nut (max)			
Shell type	A	B	C
Aluminum	0.600 / 15.24	0.126 / 3.20	12.00 ± 1.00 / 304.8 ± 25.4

USB interface - Receptacle Panel Cut Out

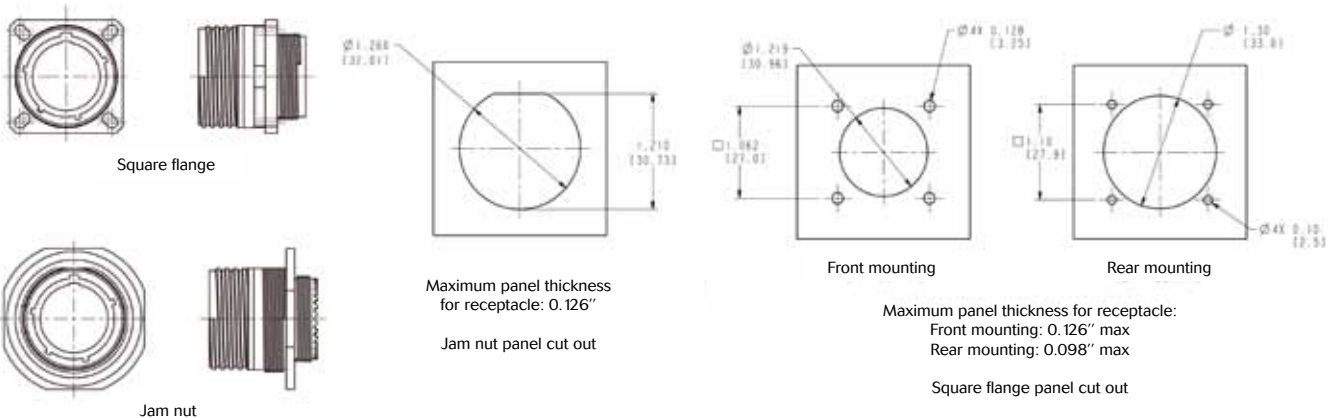

8D - RJ45-USB Series



USB interface - Plug

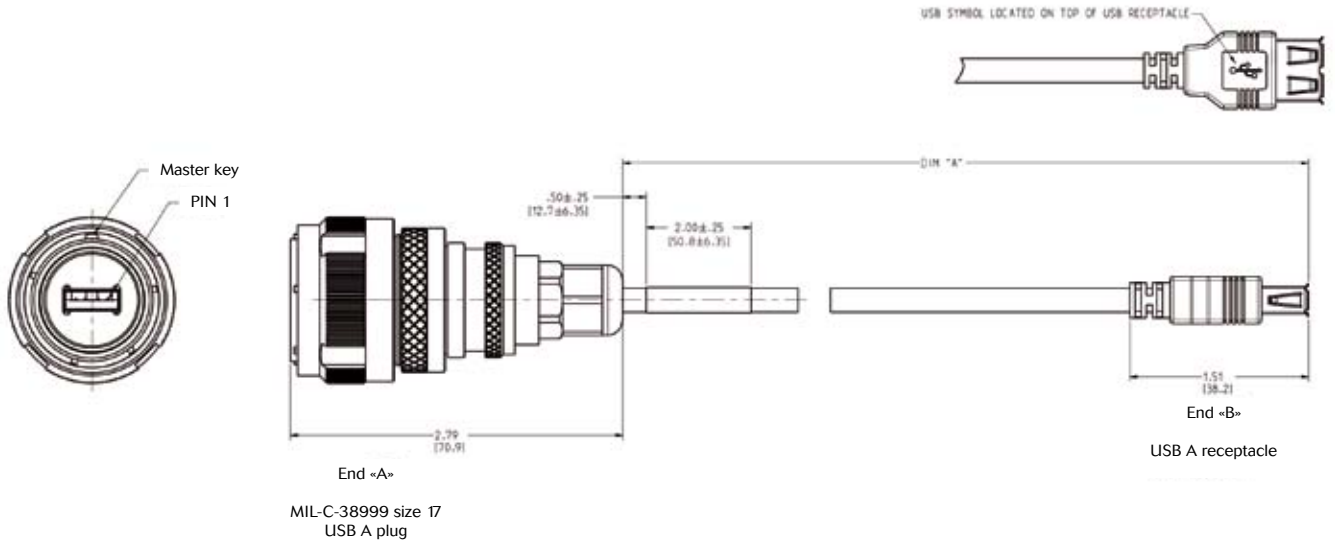

Dimensions: Inch / mm



Products range extension

8D8 / 8D9 Series

- MIL-DTL-38999 layouts and contacts
- MIL-DTL-38999 Series electric performances
- Scoop proof
- Easy mating (push mating)
- Connection in restricted space
- High vibration performance
- Compatible with standard backshells 38999 Series III
- Push Pull plug (8D8) or Push Pull plug lanyard release (8D9) available
- Lanyard release: quick disconnect with angle of separation



8DB Bulkhead Feedthrough

- “Double Receptacle” mounted on panel allows cable plug connexion on both sides of the bulkhead
- All 38999 Series III features integrated in feedthrough design
- Scoop proof
- Create a permanent sealed barrier on your panel: suitable for pressurized or depressurized areas
- Reinforced sealing - special insulator design
- Easy and reliable maintenance: time saving and low risk during maintenance
- Hermetic glass fused version available





Products range extension

8D Hermetic ELIO® Feedthrough

- The first truly hermetic aluminum 38999 fiber optic feedthrough
- Leak rate $< 10^{-9}$ atm.cm³/s
- Weight saving: aluminum shell save 30 to 40% of weight vs stainless steel
- Single and multi way: unique multiway hermetic fiber optic feedthrough in the world
- Intermateable with Souriau's ELIO® connectors:
 - Airbus A380 spec ABS1379 qualified
 - Intermateable with ARINC 801 and EN4531 standards



See «38999 Series III - Hermetic ELIO® Feedthrough» product news on www.souriau.com

8D Hermetic Aluminum 38999 Power and Signal Connector

- The unique connecting solution offering hermeticity, great conductivity and mass saving all at once: Ideal for power applications
- Truly hermetic : Leak rate $< 10^{-9}$ atm.cm³/s
- Weight saving : save 30 to 40% of weight vs stainless steel
- Outstanding conductivity : Conductivity 5 times better than regular Fe/Ni contacts



Coordinates For Straight PC Tail Terminations



Cavity identification

Viewed from front face of male insulator

Hole sizes: 1mm min. (#22 and #20 contacts) and 1.3mm min. (#16 contact) coordinates in mm.

09 / A

35

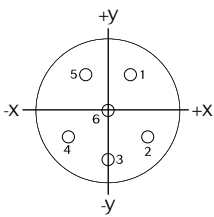

Contact	Coordinates	
	X	Y
1	+1.14	+1.98
2	+1.98	-1.14
3	0.00	-2.29
4	-1.98	-1.14
5	-1.14	+1.98
6	0.00	0.00

98

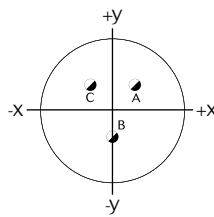

Contact	Coordinates	
	X	Y
A	+1.65	+0.97
B	0.00	-1.90
C	-1.65	+0.97

11 / B

02

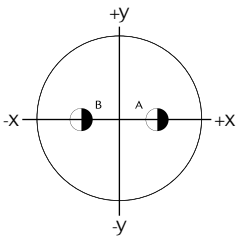

Contact	Coordinates	
	X	Y
A	0.00	+2.41
B	0.00	-2.41

04

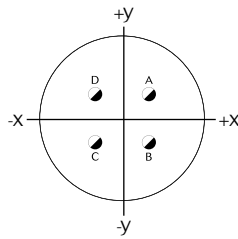

Contact	Coordinates	
	X	Y
A	+1.65	+1.65
B	+1.65	-1.65
C	-1.65	-1.65
D	-1.65	+1.65

05

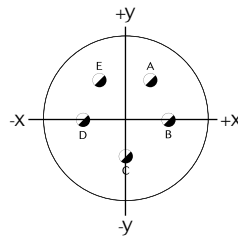

Contact	Coordinates	
	X	Y
A	+1.65	+1.42
B	+2.86	-1.65
C	0.00	-3.30
D	-2.86	-1.65
E	-1.65	+1.42

35

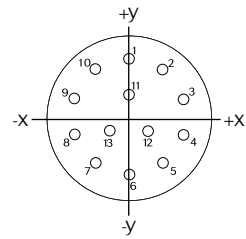

Contact	Coordinates	
	X	Y
1	0.00	+3.71
2	+2.16	+3.00
3	+3.50	+1.14
4	+3.50	-1.14
5	+2.16	-2.99
6	0.00	-3.71
7	-2.16	-2.99

Contact	Coordinates	
	X	Y
8	-3.50	-1.14
9	-3.50	+1.14
10	-2.16	+2.99
11	0.00	+1.42
12	+1.24	-0.89
13	-1.24	-0.89

98

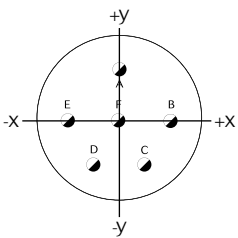

Contact	Coordinates	
	X	Y
A	0.00	+3.30
B	+3.30	0.00
C	+1.65	-2.87
D	-1.65	-2.87
E	-3.30	0.00
F	0.00	0.00

99

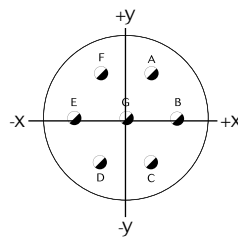

Contact	Coordinates	
	X	Y
A	+1.65	+2.85
B	+3.30	0.00
C	+1.65	-2.87
D	-1.65	-2.87
E	-3.30	0.00
F	-1.65	+2.87
G	0.00	0.00

Coordinates For Straight PC Tail Terminations



13 / C

04

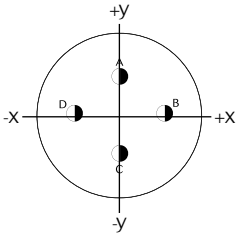

Contact	Coordinates	
	X	Y
A	0.00	+3.81
B	+3.71	+0.89
C	0.00	-2.11
D	-3.71	-0.89

08

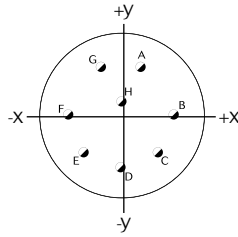

Contact	Coordinates	
	X	Y
A	+1.65	+3.99
B	+4.32	0.00
C	+3.05	-3.05
D	0.00	-4.32
E	-3.05	-3.05
F	-4.32	0.00
G	-1.65	+3.99
H	0.00	+1.12

35

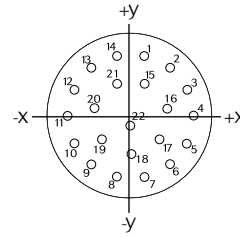

Contact	Coordinates	
	X	Y
1	+1.14	+5.00
2	+3.20	+4.01
3	+4.62	+2.24
4	+5.15	0.00
5	+4.62	-2.24
6	+3.20	-4.01
7	+1.14	-5.00
8	-1.14	-5.00
9	-3.20	-4.01
10	-4.62	-2.24
11	-5.15	0.00

Contact	Coordinates	
	X	Y
12	-4.62	+2.24
13	-3.20	+4.01
14	-1.14	+5.00
15	+1.14	+2.72
16	+2.97	+0.66
17	+2.36	-1.91
18	0.00	-3.05
19	-2.36	-1.91
20	-2.97	+0.66
21	-1.14	+2.72
22	0.00	-0.76

98

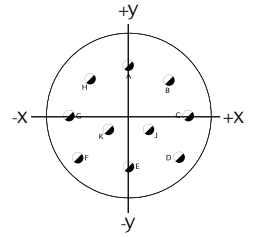

Contact	Coordinates	
	X	Y
A	0.00	+4.95
B	+3.81	+3.80
C	+4.90	+0.76
D	+4.16	-2.67
E	0.00	-3.43
F	-4.16	-2.67
G	-4.90	+0.76
H	-3.81	+3.80
J	+1.65	-0.38
K	-1.65	-0.38

Coordinates For Straight PC Tail Terminations



15 / D

05

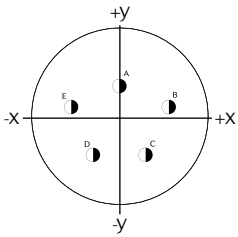

Contact	Coordinates	
	X	Y
A	0	+2.54
B	+4.42	+0.61
C	+2.39	+3.76
D	-2.39	-3.76
E	-4.42	+0.61

18

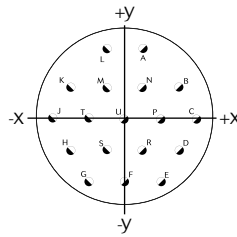

Contact	Coordinates		Contact	Coordinates	
	X	Y		X	Y
A	+1.65	+6.40	K	-4.95	+2.87
B	+4.95	+2.87	L	-1.65	+6.40
C	+6.60	0.00	M	-1.65	+2.87
D	+4.95	-2.87	N	+1.65	+2.87
E	+3.30	-5.72	P	+3.30	0.00
F	0.00	-5.72	R	+1.65	-2.87
G	-3.30	-5.72	S	-1.65	-2.87
H	-4.95	-2.87	T	-3.30	0.00
J	-6.60	0.00	U	0.00	0.00

97

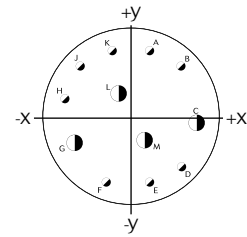

Contact	Coordinates		Contact	Coordinates	
	X	Y		X	Y
A	+1.65	+5.94	G	-5.26	-2.41
B	+4.52	+4.52	H	-5.94	+1.65
C	+5.84	-0.58	J	-4.52	+4.52
D	+4.52	-4.52	K	-1.65	+5.94
E	+1.65	-5.94	L	-1.19	+2.06
F	-2.26	-5.97	M	+1.19	-2.06

19

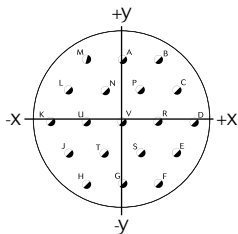

Contact	Coordinates	
	X	Y
A	0.00	+5.72
B	+3.30	+5.72
C	+4.95	+2.72
D	+6.60	0.00
E	+4.95	-2.87
F	+3.30	-5.72
G	0.00	-5.72
H	-3.30	-5.72
J	-4.95	-2.87
K	-6.60	0.00
L	-4.95	+2.87
M	-3.30	+5.72
N	-1.65	+2.87
P	+1.65	+2.87
R	+3.30	0.00
S	+1.65	-2.87
T	-1.65	-2.87
U	-3.30	0.00
V	0.00	0.00

35

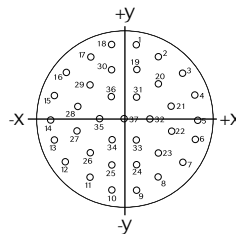

Contact	Coordinates		Contact	Coordinates	
	X	Y		X	Y
1	+1.14	+6.65	17	-3.12	+5.51
2	+3.12	+5.51	18	-1.14	+6.65
3	+5.36	+4.06	19	+1.14	+4.37
4	+6.45	+2.03	20	+3.12	+3.02
5	+6.76	-0.25	21	+4.32	+1.02
6	+6.27	-2.49	22	+4.32	-1.27
7	+5.08	-4.44	23	+3.12	-3.23
8	+3.30	-5.89	24	+1.14	-4.37
9	+1.14	-6.65	25	-1.14	-4.37
10	-1.14	-6.65	26	-3.12	-3.23
11	-3.30	-5.89	27	-4.32	-1.27
12	-5.08	-4.45	28	-4.32	+1.02
13	-6.27	-2.49	29	-3.12	+3.02
14	-6.76	-0.25	30	-1.14	+4.37
15	-6.45	+2.03	31	+1.14	+1.88
16	-5.36	+4.06	32	+2.29	-0.10
			33	+1.14	-2.08
			34	-1.14	-2.08
			35	-2.29	-0.10
			36	-1.14	+1.88
			37	0.00	-0.10

Coordinates For Straight PC Tail Terminations



17 / E

06

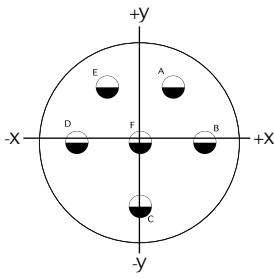

Contact	Coordinates	
	X	Y
A	+1.21	+0.21
B	+0.24	0.00
C	0.00	-0.24
D	-0.24	0.00
E	-0.12	+0.21
F	0.00	0.00

08

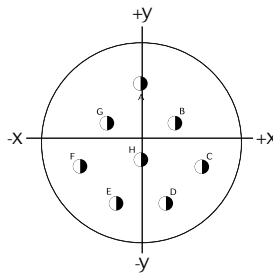

Contact	Coordinates	
	X	Y
A	0.00	+5.99
B	+3.25	+2.18
C	+5.84	-1.98
D	+2.39	-5.49
E	-2.39	-5.49
F	-5.84	-1.98
G	-3.25	+2.18
H	0.00	-1.32

26

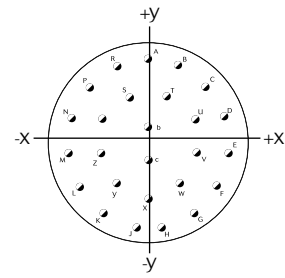

Contact	Coordinates	
	X	Y
A	0.00	+8.15
B	+3.33	+7.44
C	+6.07	+5.44
D	+7.75	+2.51
E	+8.10	-0.86
F	+7.06	-4.09
G	+4.80	-6.60
H	+1.70	-7.98
J	-1.70	-7.98
K	-4.80	-6.60
L	-7.06	-4.09
M	-8.10	-0.86
N	-7.75	+2.51

Contact	Coordinates	
	X	Y
P	-6.07	+5.44
R	-3.33	+7.44
S	-1.78	+4.50
T	+1.78	+4.50
U	+4.45	+2.39
V	+4.53	+0.91
W	+3.02	-3.84
X	0.00	-5.16
Y	-3.02	-3.84
Z	-4.53	-0.91
a	-4.45	+2.39
b	0.00	+1.65
c	0.00	-1.65

35

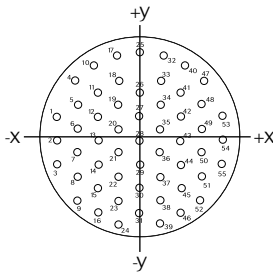

Contact	Coordinates	
	X	Y
1	-7.92	+2.18
2	-7.92	-0.10
3	-7.92	-2.39
4	-6.15	+5.61
5	-5.94	+3.33
6	-5.94	+1.04
7	-5.94	-1.24
8	-5.94	-3.53
9	-5.94	-5.82
10	-4.37	+7.09
11	-3.96	+4.47
12	-3.96	+2.18
13	-3.96	-0.10

Contact	Coordinates	
	X	Y
14	-3.96	-2.39
15	-3.96	-4.67
16	-3.96	-6.96
17	-2.26	+8.03
18	-1.98	+5.61
19	-1.98	+3.33
20	-1.98	+1.04
21	-1.98	-1.24
22	-1.98	-3.53
23	-1.98	-5.82
24	-1.98	-8.10
25	0.00	+8.36
26	0.00	+4.47

Contact	Coordinates	
	X	Y
27	0.00	+2.18
28	0.00	-0.10
29	0.00	-2.39
30	0.00	-4.67
31	0.00	-6.96
32	+2.26	+8.03
33	+1.98	+5.61
34	+1.98	+3.33
35	+1.98	+1.04
36	+1.98	-1.24
37	+1.98	-3.53
38	+1.98	-5.82
39	+1.98	-8.10
40	+4.37	+7.09
41	+3.96	+4.47
42	+3.96	+2.18
43	+3.96	-0.10
44	+3.96	-2.39
45	+3.96	-4.67
46	+3.96	-6.96
47	+6.15	+5.61
48	+5.94	+3.33
49	+5.94	+1.04
50	+5.94	-1.24
51	+5.94	-3.53
52	+5.94	-5.82
53	+7.92	+2.18
54	+7.92	-0.10
55	+7.92	-2.39

99

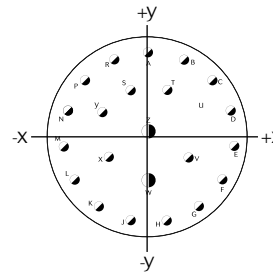

Contact	Coordinates	
	X	Y
A	0.00	+8.15
B	+3.33	+7.44
C	+6.07	+5.44
D	+7.75	+2.51
E	+8.10	-0.86
F	+7.06	-4.09
G	+4.80	-6.60
H	+1.70	-7.96
J	-1.70	-7.96
K	-4.80	-6.60
L	-7.06	-4.09
M	-8.10	-0.86
N	-7.75	+2.51
P	-6.07	+5.44
R	-3.33	+7.44
S	-1.78	+4.50
T	+1.78	+4.50
U	+4.45	+2.39
V	+3.81	-1.91
W	0.00	-4.09
X	-3.81	-1.91
Y	-4.45	+2.39
Z	0.00	+0.64

Coordinates For Straight PC Tail Terminations



19 / F

11

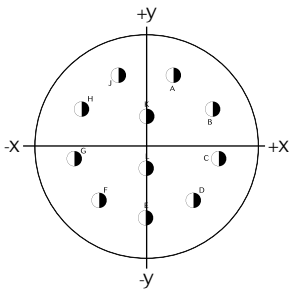

Contact	Coordinates	
	X	Y
A	+2.67	+6.60
B	+6.35	+3.35
C	+6.99	-1.35
D	+4.55	-5.46
E	0.00	-7.14
F	-4.55	-5.46
G	-6.99	-1.35
H	-6.35	+3.35
J	-2.67	+6.60
K	0.00	+2.67
L	0.00	-2.34

32

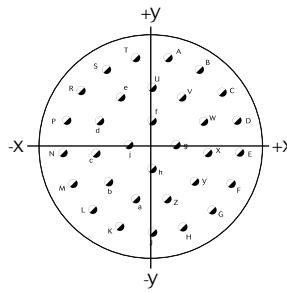

Contact	Coordinates	
	X	Y
A	+1.68	+8.97
B	+4.80	+7.75
C	+7.26	+5.51
D	+8.76	+2.49
E	+9.07	-0.84
F	+8.15	-4.06
G	+6.15	-6.73
H	+3.30	-8.51
J	0.00	-9.12
K	-3.30	-8.51
L	-6.15	-6.73
M	-8.15	-4.06
N	-9.07	-0.84
P	-8.76	+2.49
R	-7.26	+5.51
S	-4.80	+7.75

Contact	Coordinates	
	X	Y
T	-1.68	+8.97
U	0.00	+5.84
V	+3.15	+4.90
W	+5.31	+2.41
X	+5.79	-0.84
Y	+4.42	-3.84
Z	+1.65	-5.61
a	-1.65	-5.61
b	-4.42	-3.84
c	-5.79	-0.84
d	-5.31	+2.41
e	-3.15	+4.90
f	0.00	+2.44
g	+2.44	0.00
h	0.00	-2.44
j	-2.44	0.00

35

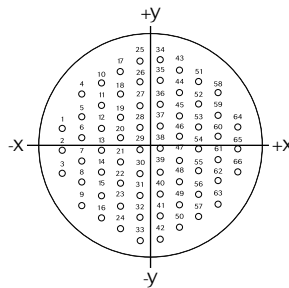

Contact	Coordinates	
	X	Y
35	+1.14	+6.86
36	+1.14	+4.57
37	+1.14	+2.29
38	+1.14	0.00
39	+1.14	-2.29
40	+1.14	-4.57
41	+1.14	-6.86
42	+1.14	-9.14
43	+3.12	+8.00
44	+3.12	+5.72
45	+3.12	+3.43
46	+3.12	+1.14
47	+3.12	-1.14
48	+3.12	-3.43
49	+3.12	-5.72
50	+3.12	-8.00
51	+5.11	+6.86
52	+5.11	+4.57
53	+5.11	+2.29
54	+5.11	0.00
55	+5.11	-2.29
56	+5.11	-4.57
57	+5.11	-6.86
58	+7.09	+5.72
59	+7.09	+3.43
60	+7.09	+1.14
61	+7.09	-1.14
62	+7.09	-3.43
63	+7.09	-5.72
64	+9.07	+2.29
65	+9.07	0.00
66	+9.07	-2.29

Contact	Coordinates	
	X	Y
1	-9.07	+2.29
2	-9.07	0.00
3	-9.07	-2.29
4	-7.09	+5.72
5	-7.09	+3.43
6	-7.09	+1.14
7	-7.09	-1.14
8	-7.09	-3.43
9	-7.09	-5.72
10	-5.11	+6.86
11	-5.11	+4.57
12	-5.11	+2.29
13	-5.11	0.00
14	-5.11	-2.29
15	-5.11	-4.57
16	-5.11	-6.86
17	-3.12	+8.00

Contact	Coordinates	
	X	Y
18	+3.12	+5.72
19	-3.12	+3.43
20	-3.12	+1.14
21	-3.12	-1.14
22	-3.12	-3.43
23	-3.12	-5.72
24	-3.12	-8.00
25	-1.14	+9.14
26	-1.14	+6.86
27	-1.14	+4.57
28	-1.14	+2.29
29	-1.14	0.00
30	-1.14	-2.29
31	-1.14	-4.57
32	-1.14	-6.86
33	-1.14	-9.14
34	+1.14	+9.14

Coordinates For Straight PC Tail Terminations



21 / G

16

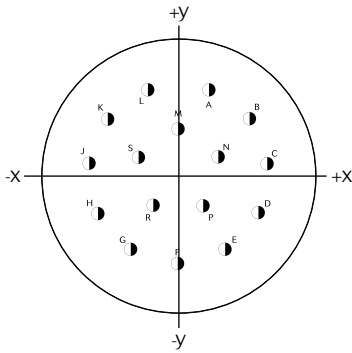

Contact	Coordinates	
	X	Y
A	+3.00	+8.18
B	+6.88	+5.36
C	+8.66	+0.914
D	+7.82	-3.81
E	+4.62	-7.37
F	0.00	-8.71
G	-4.62	-7.37
H	-7.82	-3.81
J	-8.66	+0.91
K	-6.88	+5.36
L	-3.00	+8.18
M	0.00	+4.45
N	+3.91	+1.57
P	+2.39	-3.10
R	-2.39	-3.10
S	-3.91	+1.57

39

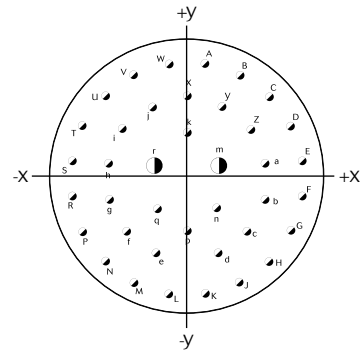

Contact	Coordinates	
	X	Y
A	+1.65	+10.44
B	+4.80	+9.42
C	+7.47	+7.47
D	+9.42	+4.80
E	+10.44	+1.65
F	+10.44	-1.65
G	+9.42	-4.80
H	+7.47	-7.47
J	+4.80	-9.42
K	+1.65	-10.44
L	-1.65	-10.44
M	-4.80	-9.42
N	-7.47	-7.47
P	-9.42	-4.80
R	-10.44	-1.65
S	-10.44	+1.65
T	-9.42	+4.80
U	-7.47	+7.47
V	-4.80	+9.42
W	-1.65	+10.44

Contact	Coordinates	
	X	Y
X	0.00	+7.49
Y	+3.20	+6.50
Z	+5.89	+4.55
a	+7.11	+1.45
b	+7.11	-1.88
c	+5.51	-4.80
d	+2.84	-6.73
e	-2.84	-6.73
f	-5.51	-4.80
g	-7.11	-1.88
h	-7.11	+1.45
i	-5.89	+4.55
j	-3.20	+6.50
k	0.00	+4.17
m	+2.90	+1.22
n	+2.69	-2.72
p	0.00	-4.80
q	-2.69	-2.72
r	-2.90	+1.22

35

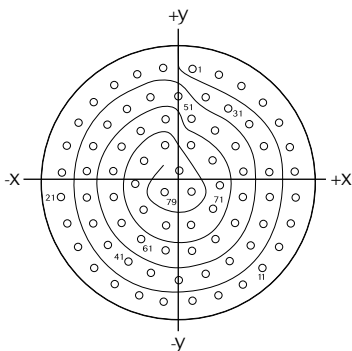

Contact	Coordinates	
	X	Y
41	-2.49	-8.18
42	-4.67	-7.11
43	-6.55	-5.59
44	-7.90	-3.58
45	-8.43	-1.22
46	-8.43	+1.22
47	-7.90	+3.58
48	-6.55	+5.59
49	-4.67	+7.11
50	-2.49	+8.18
51	-1.22	+6.12
52	+1.22	+6.12
53	+3.40	+5.05
54	+5.28	+3.53
55	+6.02	+1.22
56	+6.02	-1.22
57	+5.28	-3.53
58	+3.40	-5.05
59	+1.22	-6.12
60	-1.22	-6.12
61	-3.40	-5.05
62	-5.28	-3.53
63	-6.02	-1.22
64	-6.02	+1.22
65	-5.28	+3.53
66	-3.40	+5.05
67	-1.22	+3.71
68	+1.22	+3.71
69	+3.18	+2.29
70	+3.94	0.00
71	+3.18	-2.29
72	+1.22	-3.71
73	-1.22	-3.71
74	-3.18	-2.29
75	-3.94	0.00
76	-3.18	+2.29
77	0.00	+1.35
78	+1.22	-0.74
79	-1.22	-0.74

Contact	Coordinates	
	X	Y
1	+1.35	+10.82
2	+3.71	+10.26
3	+5.89	+9.19
4	+7.77	+7.67
5	+9.27	+5.77
6	+10.31	+3.58
7	+10.85	+1.22
8	+10.85	-1.22
9	+10.31	-3.58
10	+9.27	-5.77
11	+7.77	-7.67
12	+5.89	-9.19
13	+3.71	-10.26
14	+1.35	-10.82
15	-1.35	-10.82
16	-3.71	-10.26
17	-5.89	-9.19
18	-7.77	-7.67
19	-9.27	-5.77
20	-10.31	-3.58

Contact	Coordinates	
	X	Y
21	-10.85	-1.22
22	-10.85	+1.22
23	-10.31	+3.58
24	-9.27	+5.77
25	-7.77	+7.67
26	-5.89	+9.19
27	-3.71	+10.26
28	-1.35	+10.82
29	0.00	+8.20
30	+2.49	+8.18
31	+4.67	+7.11
32	+6.55	+5.59
33	+7.90	+3.58
34	+8.43	+1.22
35	+8.43	-1.22
36	+7.90	-3.58
37	+6.55	-5.59
38	+4.67	-7.11
39	+2.49	-8.18
40	0.00	-8.81

41

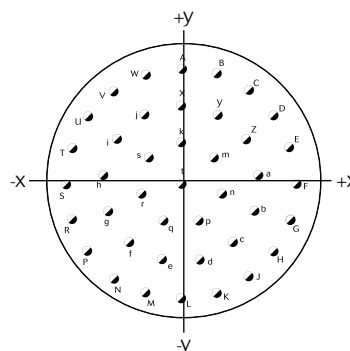

Contact	Coordinates	
	X	Y
A	0.00	+10.60
B	+3.28	+10.09
C	+6.23	+8.58
D	+8.58	+6.23
E	+10.09	+3.28
F	+10.60	0.00
G	+10.09	-3.28
H	+8.58	-6.23

Contact	Coordinates	
	X	Y
J	+6.23	-8.58
K	+3.28	-10.09
L	0.00	-10.60
M	-3.28	-10.09
N	-6.23	-8.58
P	-8.58	-6.23
R	-10.09	-3.28
S	-10.60	0.00

Contact	Coordinates	
	X	Y
T	-10.09	+3.28
U	-8.58	+6.23
V	-6.23	+8.58
W	-3.28	+10.09
X	0.00	+7.20
Y	+3.35	+6.38
Z	+5.92	+4.09
a	+7.15	+0.87
b	+6.73	-2.55
c	+4.78	-5.39
d	+1.73	-6.99
e	-1.73	-6.99
f	-4.78	-5.39
g	-6.73	-2.55
h	-7.15	+0.87
i	-5.92	+4.09
j	-3.35	+6.38
k	0.00	+3.81
m	+2.98	+2.38
n	+3.71	-0.85
p	-1.66	-3.43
q	+1.66	-3.43
r	-3.71	-0.85
s	-2.98	+2.38
t	0.00	0.00

Coordinates For Straight PC Tail Terminations



23 / H

21

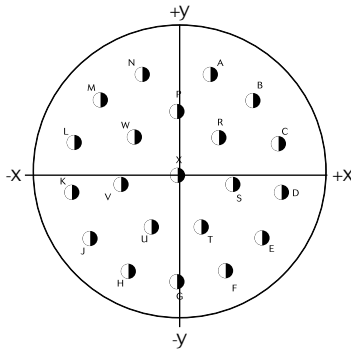

Contact	Coordinates	
	X	Y
A	+3.25	+9.78
B	+7.34	+7.24
C	+9.80	+3.12
D	+10.16	-1.65
E	+8.33	-6.07
F	+4.65	-9.19
G	0.00	-10.31
H	-4.65	-9.19
J	-8.33	-6.07
K	-10.16	-1.65
L	-9.80	+3.12

Contact	Coordinates	
	X	Y
M	-7.34	+7.24
N	-3.25	+9.78
P	0.00	+6.22
R	+4.06	+3.71
S	+5.44	-0.89
T	+2.39	-4.93
U	-2.39	-4.93
V	-5.44	-0.89
W	-4.06	+3.71
X	0.00	0.00

53

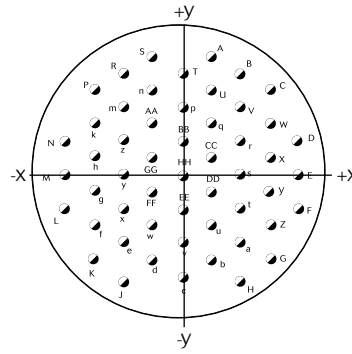

Contact	Coordinates	
	X	Y
A	+4.98	+12.70
B	+7.98	+11.05
C	+10.49	+8.71
D	+12.32	+5.84
E	+13.39	+2.57
F	+13.61	-0.76
G	+12.98	-4.17
H	+11.53	-7.29
J	+9.35	-9.93
K	+6.58	-11.94
L	+3.40	13.18
M	0.00	-13.64

Contact	Coordinates	
	X	Y
N	-3.40	-13.18
P	-6.58	-11.94
R	-9.35	-9.93
S	-11.53	-7.29
T	-12.98	-4.17
U	-13.61	-0.76
V	-13.39	+2.57
W	-12.32	+5.84
X	-10.49	+8.71
Y	-7.98	+11.05
Z	-4.98	12.70

Contact	Coordinates	
	X	Y
a	-1.73	+11.53
b	+1.73	+11.53
c	+4.39	+9.22
d	+7.24	+7.19
e	+9.19	+4.45
f	+10.13	+1.17
g	+9.96	-2.24
h	+8.66	-5.41
i	+6.38	-7.98
j	+3.38	-9.63
k	0.00	-10.21
m	-3.38	-9.63
n	-6.38	-7.98
p	-8.66	-5.41
q	-9.96	-2.24
r	-10.13	+1.17
s	-9.19	+4.45
t	-7.24	+7.19
u	-4.39	+9.22
v	0.00	+8.59
w	+3.73	+5.66
x	+6.02	+3.10
y	+6.78	-0.25
z	+5.79	-3.53
AA	+3.33	-5.92
BB	0.00	-6.78
CC	-3.33	-5.92
DD	-5.79	-3.53
EE	-6.78	-0.25
FF	-6.02	+3.10
GG	-3.73	+5.66
HH	0.00	+5.08
JJ	+2.67	+2.39
KK	+3.43	-1.04
LL	0.00	-3.35
MM	-3.43	-1.04
NN	-2.67	+2.39
PP	0.00	0.00

Coordinates For Straight PC Tail Terminations



25 / J

04

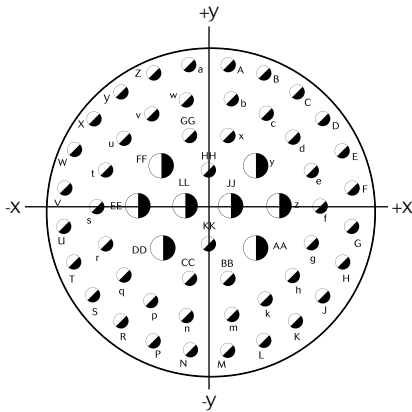

Contact	Coordinates		Contact	Coordinates		Contact	Coordinates	
	X	Y		X	Y		X	Y
A	+1.75	+13.49	a	-1.75	+13.49	AA	+4.37	-3.78
B	+5.49	+12.57	b	+2.18	+10.08	BB	+1.75	-6.66
C	+8.23	+10.80	c	+5.38	+8.78	CC	-1.75	-6.66
D	+10.77	+8.28	d	+7.90	+6.38	DD	-4.37	+3.78
E	+12.52	+5.21	e	+9.58	+3.35	EE	-6.55	0.00
F	+13.49	+1.75	f	+10.46	0.00	FF	-4.37	+3.78
G	+13.49	-1.75	g	+9.58	-3.35	GG	-1.75	+6.66
H	+12.52	-5.21	h	+7.90	-6.38	HH	0.00	+3.35
J	+10.77	-8.28	k	+5.38	-8.78	JJ	+2.18	0.00
K	+8.23	-10.80	m	+2.18	-10.08	KK	0.00	-3.35
L	+5.16	-12.57	n	-2.18	-10.08	LL	+2.18	0.00
M	+1.75	-13.49	p	-5.38	-8.78			
N	-1.75	-13.49	q	-7.90	-6.38			
P	-5.16	-12.57	r	-9.58	-3.35			
R	-8.23	-10.80	s	-10.46	0.00			
S	-10.77	-8.28	t	-9.58	+3.35			
T	-12.52	-5.21	u	-7.90	+6.38			
U	-13.49	-1.75	v	-5.38	+8.78			
V	-13.49	+1.75	w	-2.18	+10.08			
W	-12.52	+5.21	x	+1.75	+6.66			
X	-10.77	+8.28	y	+4.37	+3.78			
Y	-8.23	+10.80	z	+6.55	0.00			
Z	-5.16	+12.57						

29

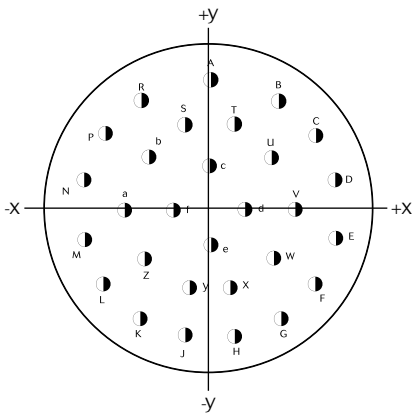

Contact	Coordinates		Contact	Coordinates	
	X	Y		X	Y
A	0.00	-12.22	R	-6.55	+10.31
B	+6.55	+10.31	S	-2.31	+8.15
C	+10.03	+7.04	T	+2.31	+8.15
D	+11.91	+2.77	U	+5.79	+4.93
E	+11.91	-2.77	V	+8.10	0.00
F	+10.03	-7.04	W	+6.10	-4.60
G	+6.68	-10.31	X	+2.31	-7.37
H	+2.31	-11.99	Y	-2.31	-7.37
J	-2.31	-11.99	Z	-6.10	-4.60
K	-6.68	-10.31	a	-8.10	0.00
L	-10.03	-7.04	b	-5.79	+4.93
M	-11.91	-2.77	c	0.00	+4.09
N	-11.91	+2.77	d	+3.40	0.00
P	-10.03	+7.04	e	0.00	-3.30
			f	-3.40	0.00

35

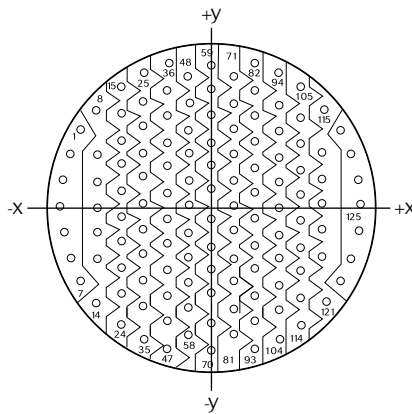

Contact	Coordinates		Contact	Coordinates	
	X	Y		X	Y
A	+4.98	+12.70	M	0.00	-13.64
B	+7.98	+11.05	N	-3.40	-13.18
C	+10.49	+8.71	P	-6.58	-11.94
D	+12.32	+5.84	R	-9.35	-9.93
E	+13.39	+2.57	S	-11.53	-7.29
F	+13.61	-0.76	T	-12.98	-4.17
G	+12.98	-4.17	U	-13.61	-0.76
H	+11.53	-7.29	V	-13.39	+2.57
J	+9.35	-9.93	W	-12.32	+5.84
K	+6.58	-11.94	X	-10.49	+8.71
L	+3.40	13.18	Y	-7.98	+11.05
			Z	-4.98	+12.70

Contact	Coordinates	
	X	Y
a	-1.73	+11.53
b	-1.73	+11.53
c	+4.39	+9.22
d	+7.24	+7.19
e	+9.19	+4.45
f	+10.13	+1.17
g	+9.96	-2.24
h	+8.66	-5.41
i	+6.38	-7.98
j	+3.38	-9.63
k	0.00	-10.21
m	-3.38	-9.63
n	-6.38	-7.98
p	-8.66	-5.41
q	-9.96	-2.24
r	-10.13	+1.17
s	-9.19	+4.45
t	-7.24	+7.19
u	-4.39	+9.22
v	0.00	+8.59
w	+3.73	+5.66
x	+6.02	+3.10
y	+6.78	-0.25
z	+5.79	-3.53
AA	+3.33	-5.92
BB	0.00	-6.78
CC	-3.33	-5.92
DD	-5.79	-3.53
EE	-6.78	-0.25
FF	-6.02	+3.10
GG	-3.73	+5.66
HH	0.00	+5.08
JJ	+2.67	+2.39
KK	+3.43	-1.04
LL	0.00	-3.35
MM	-3.43	-1.04
NN	-2.67	+2.39
PP	0.00	0.00

Coordinates For Straight PC Tail Terminations



25 / J

43

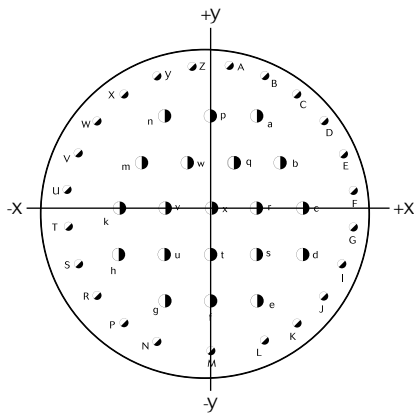

Contact	Coordinates		Contact	Coordinates	
	X	Y		X	Y
A	+1.75	+13.49	a	+4.37	+8.74
B	+5.16	+12.57	b	+6.55	+4.37
C	+8.23	+10.80	c	+8.74	0.00
D	+10.77	+8.28	d	+8.74	-4.37
E	+12.52	+5.21	e	+4.37	-8.74
F	+13.49	+1.75	f	0.00	-8.74
G	+13.49	-1.75	g	-4.37	-8.74
H	+12.52	-5.21	h	-8.74	-4.37
J	+10.77	-8.28	k	-8.74	0.00
K	+8.23	-10.80	m	-6.55	+4.37
L	+5.16	-12.57	n	-4.37	+8.74
M	0.00	-13.49	p	0.00	+8.74
N	-5.16	-12.57	q	+2.18	+4.37
P	-8.23	-10.80	r	+4.37	0.00
R	-10.77	-8.28	s	+4.37	-4.37
S	-12.52	-5.21	t	0.00	-4.37
T	-13.49	-1.75	u	-4.37	-4.37
U	-13.49	+1.75	v	-4.37	0.00
V	-12.52	+5.21	w	-2.18	+4.37
W	-10.77	+8.28	x	0.00	0.00
X	-8.23	+10.80			
Y	-5.16	+12.57			
Z	-1.75	+13.49			

61

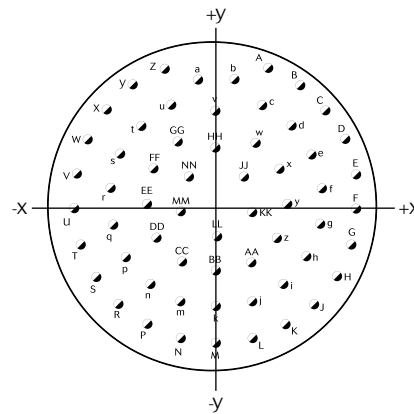

Contact	Coordinates		Contact	Coordinates	
	X	Y		X	Y
A	+4.98	+12.70	a	-1.73	+11.53
B	+7.98	+11.05	b	+1.73	+11.53
C	+10.49	+8.71	c	+4.39	+9.22
D	+12.32	+5.84	d	+7.24	+7.19
E	+13.39	+2.57	e	+9.19	+4.45
F	+13.61	-0.76	f	+10.13	+1.17
G	+12.98	-4.17	g	+9.96	-2.24
H	+11.53	-7.29	h	+8.66	-5.41
J	+9.35	-9.93	i	+6.38	-7.98
K	+6.58	-11.94	k	0.00	-10.21
L	+3.40	-13.18	m	-3.38	-9.63
M	0.00	-13.64	n	-6.38	-7.98
N	-3.40	-13.18	p	-8.66	-5.41
P	-6.58	-11.94	q	-9.96	-2.24
R	-9.35	-9.93	r	-10.13	+1.17
S	-11.53	-7.29	s	-9.19	+4.45
T	-12.98	-4.17	t	-7.24	+7.19
U	-13.61	-0.76	u	-4.39	+9.22
V	-13.39	+2.57	v	0.00	+8.59
W	-12.32	+5.84	w	+3.73	+5.66
X	-10.49	+8.71	x	+6.02	+3.10
Y	-7.98	+11.05	y	+6.78	-0.25
Z	-4.98	+12.10	z	+5.79	-3.53
			AA	+3.33	-5.92
			BB	0.00	-6.78
			CC	-3.33	-5.92
			DD	-5.79	-3.53
			EE	-6.78	-0.25
			FF	-6.02	+3.10
			GG	-3.73	+5.66
			HH	0.00	+5.08
			JJ	+2.67	+2.39
			KK	+3.43	-1.04
			LL	0.00	-3.35
			MM	-3.43	-1.04
			NN	-2.67	+2.39
			PP	0.00	0.00

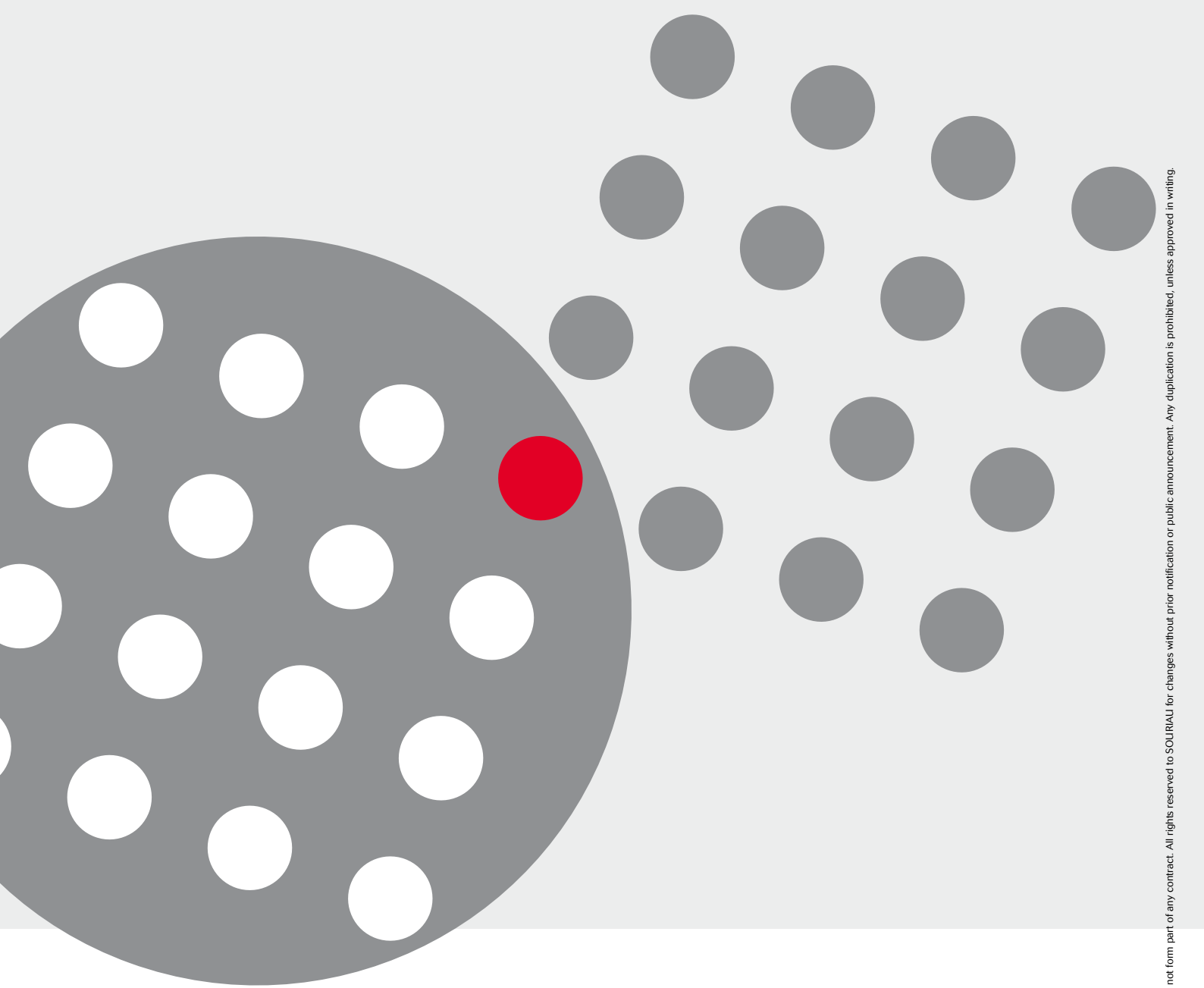

www.souriau.com
contactmilaero@souriau.com

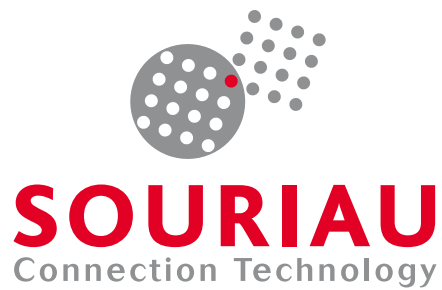



Компания «ЭлектроПласт» предлагает заключение долгосрочных отношений при поставках импортных электронных компонентов на взаимовыгодных условиях!

Наши преимущества:

- Оперативные поставки широкого спектра электронных компонентов отечественного и импортного производства напрямую от производителей и с крупнейших мировых складов;
- Поставка более 17-ти миллионов наименований электронных компонентов;
- Поставка сложных, дефицитных, либо снятых с производства позиций;
- Оперативные сроки поставки под заказ (от 5 рабочих дней);
- Экспресс доставка в любую точку России;
- Техническая поддержка проекта, помощь в подборе аналогов, поставка прототипов;
- Система менеджмента качества сертифицирована по Международному стандарту ISO 9001;
- Лицензия ФСБ на осуществление работ с использованием сведений, составляющих государственную тайну;
- Поставка специализированных компонентов (Xilinx, Altera, Analog Devices, Intersil, Interpoint, Microsemi, Aeroflex, Peregrine, Syfer, Eurofarad, Texas Instrument, Miteq, Cobham, E2V, MA-COM, Hittite, Mini-Circuits, General Dynamics и др.);

Помимо этого, одним из направлений компании «ЭлектроПласт» является направление «Источники питания». Мы предлагаем Вам помощь Конструкторского отдела:

- Подбор оптимального решения, техническое обоснование при выборе компонента;
- Подбор аналогов;
- Консультации по применению компонента;
- Поставка образцов и прототипов;
- Техническая поддержка проекта;
- Защита от снятия компонента с производства.



Как с нами связаться

Телефон: 8 (812) 309 58 32 (многоканальный)

Факс: 8 (812) 320-02-42

Электронная почта: org@eplast1.ru

Адрес: 198099, г. Санкт-Петербург, ул. Калинина, дом 2, корпус 4, литера А.