

FUJITSU FM3

SK-FM3-100PMC (-JLINK)

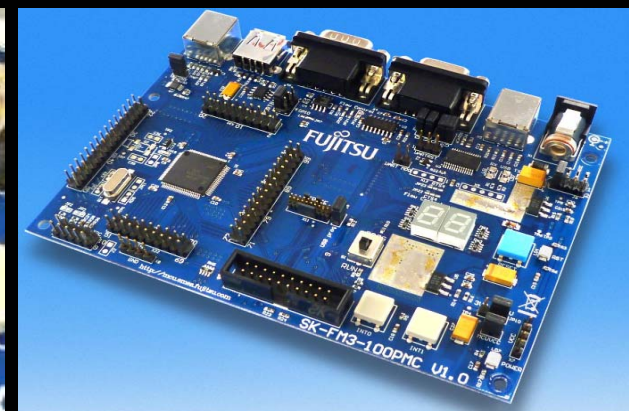



Warranty and Disclaimer

The use of the deliverables (e.g. software, application examples, target boards, evaluation boards, starter kits, schematics, engineering samples of IC's etc.) is subject to the conditions of Fujitsu Semiconductor Europe GmbH ("FSEU") as set out in (i) the terms of the License Agreement and/or the Sale and Purchase Agreement under which agreements the Product has been delivered, (ii) the technical descriptions and (iii) all accompanying written materials.

Please note that the deliverables are intended for and must only be used for reference in an evaluation laboratory environment.

The software deliverables are provided on an as-is basis without charge and are subject to alterations. It is the user's obligation to fully test the software in its environment and to ensure proper functionality, qualification and compliance with component specifications.

Regarding hardware deliverables, FSEU warrants that they will be free from defects in material and workmanship under use and service as specified in the accompanying written materials for a duration of 1 year from the date of receipt by the customer.

Should a hardware deliverable turn out to be defect, FSEU's entire liability and the customer's exclusive remedy shall be, at FSEU's sole discretion, either return of the purchase price and the license fee, or replacement of the hardware deliverable or parts thereof, if the deliverable is returned to FSEU in original packing and without further defects resulting from the customer's use or the transport. However, this warranty is excluded if the defect has resulted from an accident not attributable to FSEU, or abuse or misapplication attributable to the customer or any other third party not relating to FSEU or to unauthorised decompiling and/or reverse engineering and/or disassembling.

FSEU does not warrant that the deliverables do not infringe any third party intellectual property right (IPR). In the event that the deliverables infringe a third party IPR it is the sole responsibility of the customer to obtain necessary licenses to continue the usage of the deliverable.

In the event the software deliverables include the use of open source components, the provisions of the governing open source license agreement shall apply with respect to such software deliverables.

To the maximum extent permitted by applicable law FSEU disclaims all other warranties, whether express or implied, in particular, but not limited to, warranties of merchantability and fitness for a particular purpose for which the deliverables are not designated.

To the maximum extent permitted by applicable law, FSEU's liability is restricted to intention and gross negligence. FSEU is not liable for consequential damages.

Should one of the above stipulations be or become invalid and/or unenforceable, the remaining stipulations shall stay in full effect.

The contents of this document are subject to change without a prior notice, thus contact FSEU about the latest one.

This board and its deliverables must only be used for test applications in an evaluation laboratory environment.



Overview

■ Introduction

- About the SK-FM3-100PMC
- SK-FM3-100PMC content
- SK-FM3-100PMC-JLINK content
- Test it
- The hardware
- The software

■ Try yourself

- Software examples
- Program download
- IAR-Embedded Workbench
- KEIL μ Vision

■ Contacts

■ **Additional documents**

- Schematic 'SK-FM3-100PMC'
- Data sheet MB9B500 Series
- Peripheral Manual
 - Errata sheet
- Technical Reference Manual
- Flash Programming Manual

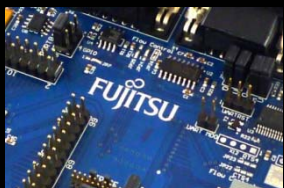
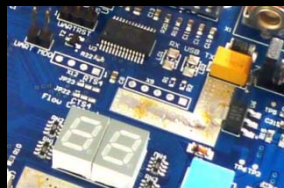
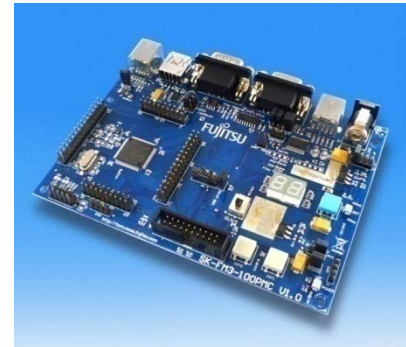



About the SK-FM3-100PMC

The SK-FM3-100PMC is available in two versions:

- The SK-FM3-100PMC includes a low-cost evaluation board based on the Fujitsu FM3 microcontroller MB9B500 Series
- SK-FM3-100PMC-JLINK includes a low-cost evaluation board based on the Fujitsu FM3 microcontroller MB9B500 Series and the JTAG adapter J-Link

■ The MB9B500 Series includes the following features:

- Up to 512 KByte Flash Memory
- Up to 64 KByte RAM
- Up to 2 CAN controller 2.0A/B
- Up to 8 LIN-USART-I²C interfaces
- USB-Host/-Device interface
- Timers (ICUs, OCUs, PPGs, others)
- Up to three 12 Bit ADC
- External interrupts

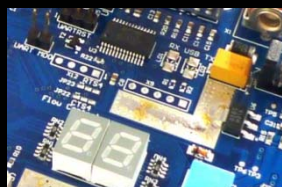



About the SK-FM3-100PMC

■ Features of the SK-FM3-100PMC board:

- Microcontroller MB9BF506N
- 1x UART-Transceiver (SUB-D9 connector)
- 1x USB to serial converter (Type-B connector)
- 1x High-speed CAN-Transceiver (SUB-D9 connector)
- 1x USB-MiniHost (Type-A connector)
- 1x USB-Device (Type-B connector)
- JTAG- and TRACE-Interface each on a 20 pin-header
- TSC-Interface to connect for example the Fujitsu SK-TSC-1127S-SB
- 2x LED-Display (7-Segment)
- 2x 'User'-button
- 1x 'Reset'-button, 'Reset'-LED
- All 100 pins routed to pin-header
- On-board 5V and 3V voltage regulators, 'Power'-LED
- Power supply via USB (UART'B'), USB-Device, JTAG or external with a 8V to 12V power connector

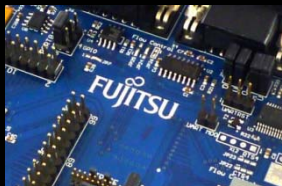
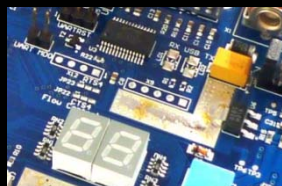



SK-FM3-100PMC content

■ The SK-FM3-100PMC contains

- SK-FM3-100PMC evaluation board with MB9BF506N
- USB cable
- CD: Documentation, USB driver, Software examples, Programmer

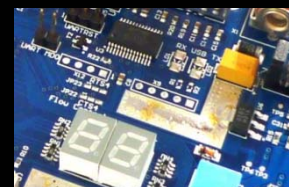
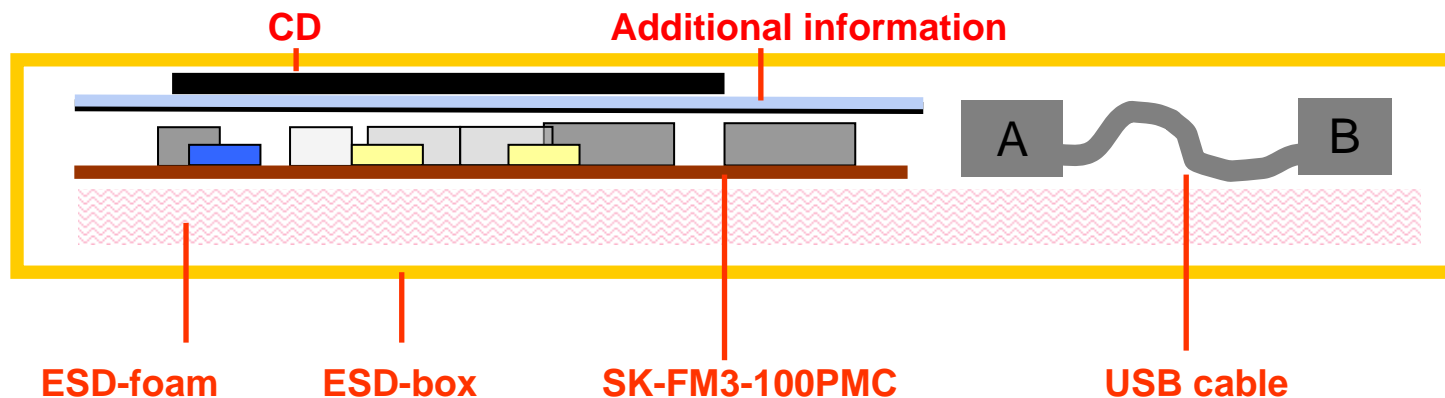

SK-FM3-100PMC-JLINK content

■ The SK-FM3-100PMC-JLINK contains

- SK-FM3-100PMC evaluation board with MB9BF506N
- USB cable
- CD: Documentation, USB driver, Software examples, Programmer
- Segger J-Link JTAG adapter incl. USB cable

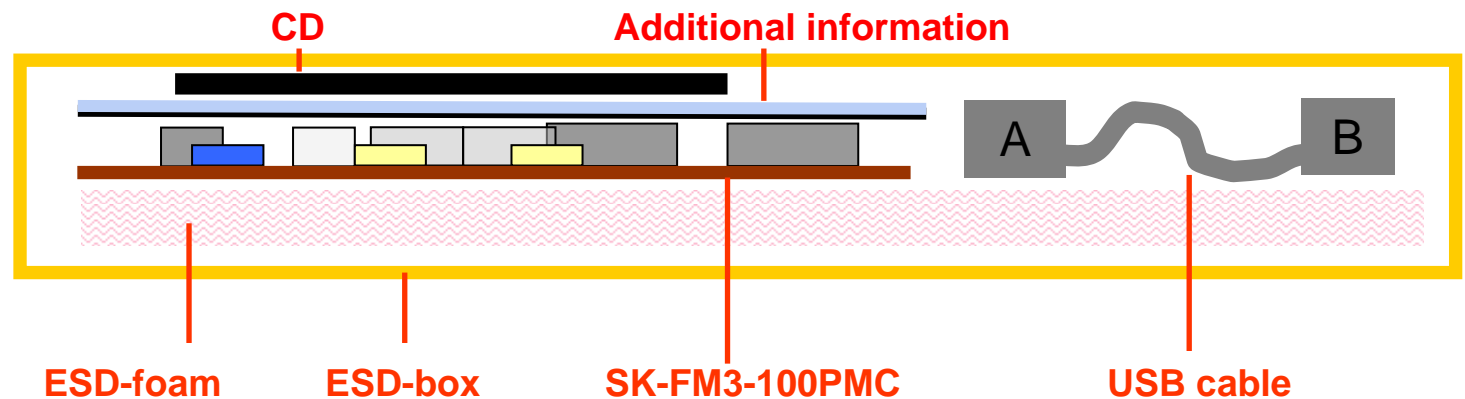
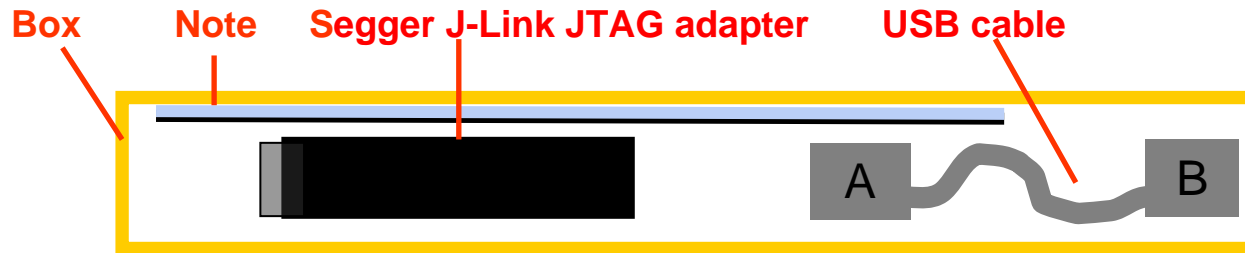



Test it

- The microcontroller on the SK-FM3-100PMC is already preprogrammed with a simple application.

- Connect the SK-FM3-100PMC via USB (X5) with the PC
- Install the USB driver from the CD
- Press the 'Reset'- Button
- The SK-FM3-100PMC will automatically start counting
- The count direction can be changed by pressing the key buttons

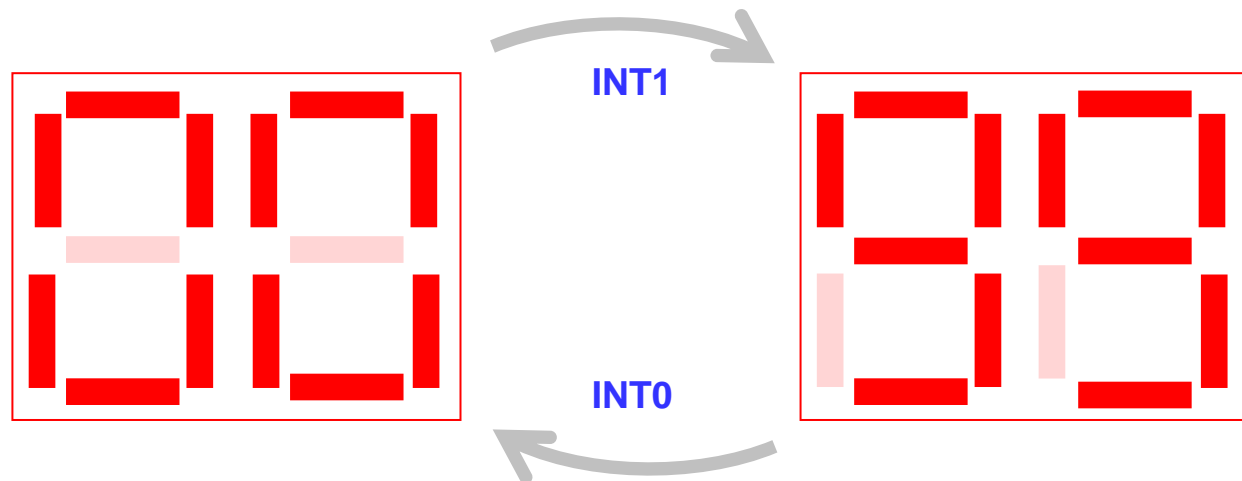



Test it

Congratulations!

- You finished successfully the first test
- Now you will get more details about the SK-FM3-100PMC
- You will learn more about
 - The on-board features
 - How to program the Flash
 - How to start with IAR-Embedded-Workbench and KEIL μ Vision

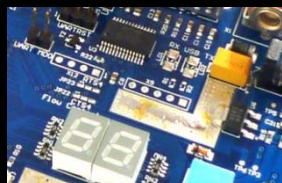



The Hardware

■ Main features

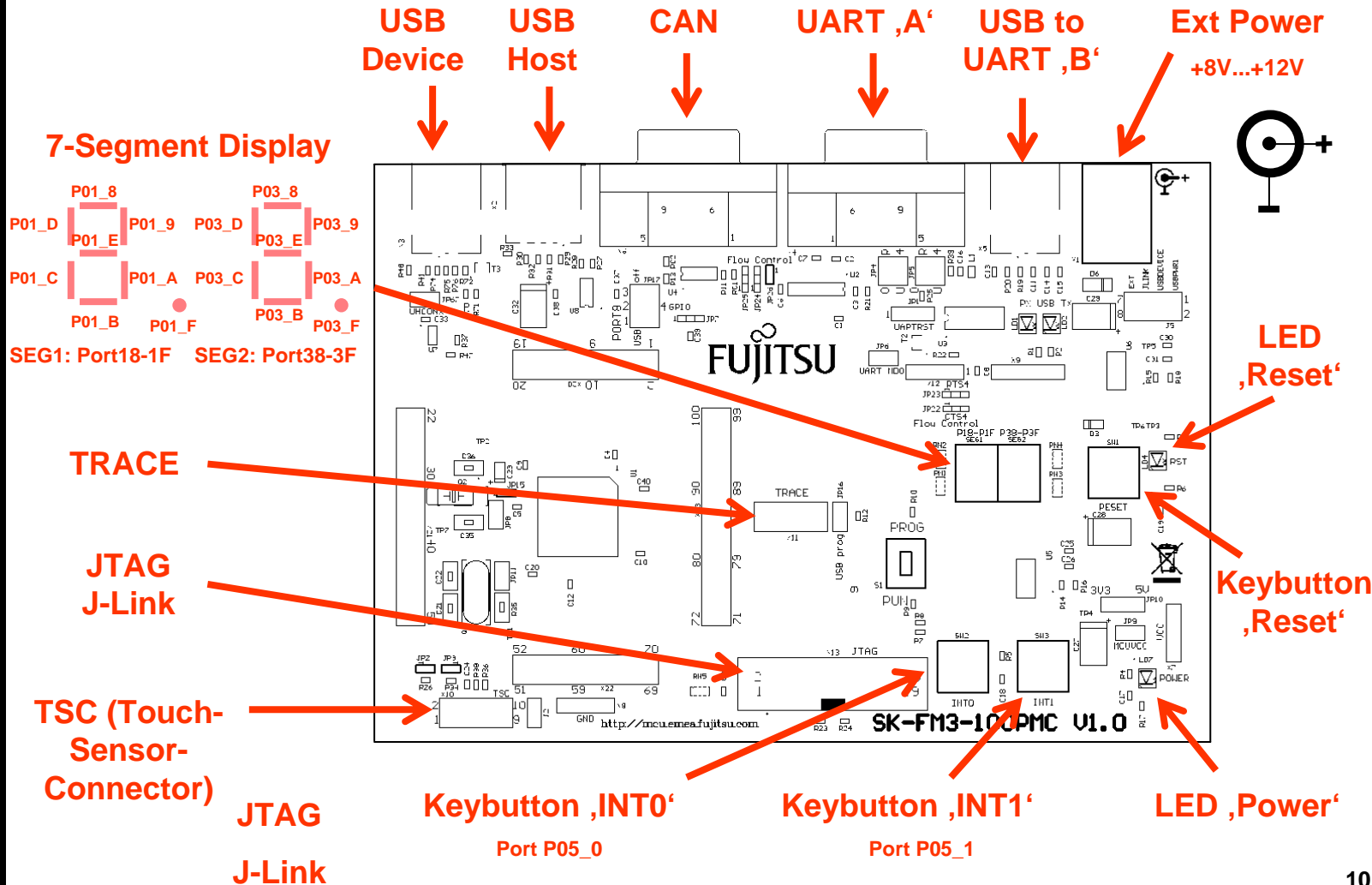
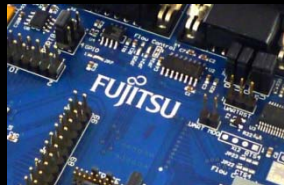
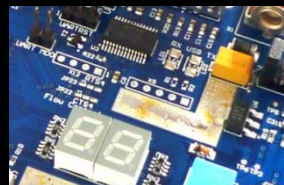

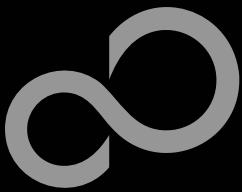

The Hardware

■ The jumpers

JP4: UART RX select

R-0: UART0=UART'A' / U-4: UART4=UART'B' (USB)
R-4: UART4=UART'A' / U-0: UART0=UART'B' (USB)

JP5: UART TX select

R-0: UART0=UART'A' / U-4: UART4=UART'B' (USB)
R-4: UART4=UART'A' / U-0: UART0=UART'B' (USB)

JP1: DTR-Reset

- 1-2: DTR-Signal of the UART connector is connected to the MCU reset-pin.
- 2-3: DTR-Signal of the USB connector is connected to the MCU reset-pin.

Some terminal-programs, e.g. Fujitsu's Skwizard, allow to reset the evaluation board by using the DTR-Signal.

JP6: MD0 selection

Close this jumper to control the MD0 level by the RTS signal of the USB interface

S1: Mode selection

- PROG: Program-mode
- RUN: Run-mode

JP10: 5V / 3.3V

- 1-2: 5V supply is used
- 2-3: 3.3V supply is used

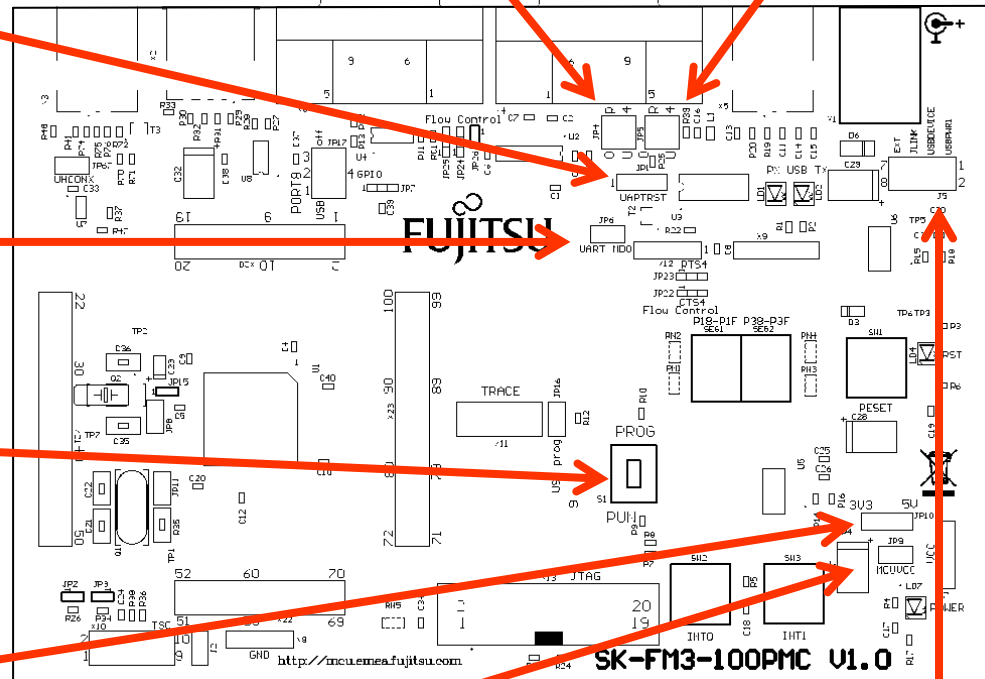

JP9: MCU Vcc

This jumper can be used to measure the current consumption of the MCU

J5: Power Supply

- 1-2: USB (UART ,B') supply
- 3-4: USB Device supply
- 5-6: JLINK supply
- 7-8: External supply

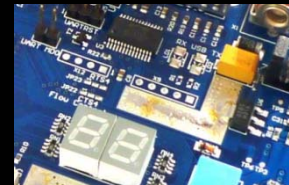



The Hardware

■ The jumpers

JP24-JP26: Flow Control UART4

JP24

1-2: Flow control disabled
2-3: Flow control enabled

JP25

1-2: Flow control enabled
2-3: Flow control disabled

JP26

open: Flow control disabled
closed: Flow control enabled

JP17: Port8 (USB use)

1-2: USB in use
2-3: USB not in use
2-4: Use Port 8 as digital I/O

JP67: USB Function HCONX

Open: D+ is not pulled up
Closed: HCONX controls Pullup of D+

JP16: USB prog

(for PROG-Mode S1)

Open: UART programming enabled
Closed: USB programming enabled

JP2: Pullup resistor TSC

Closed: Pull up SCL3

JP3: Pullup resistor TSC

Closed: Pull up SDA3

JP22,JP23: Flow Control CTS4, DTS4

JP22, JP23 1-2: Flow control on UART'A'
JP22, JP23 2-3: Flow control on UART'B'
JP22, JP23 Open: Flow control disabled

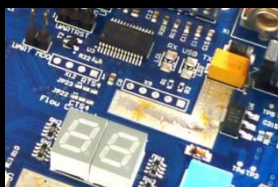
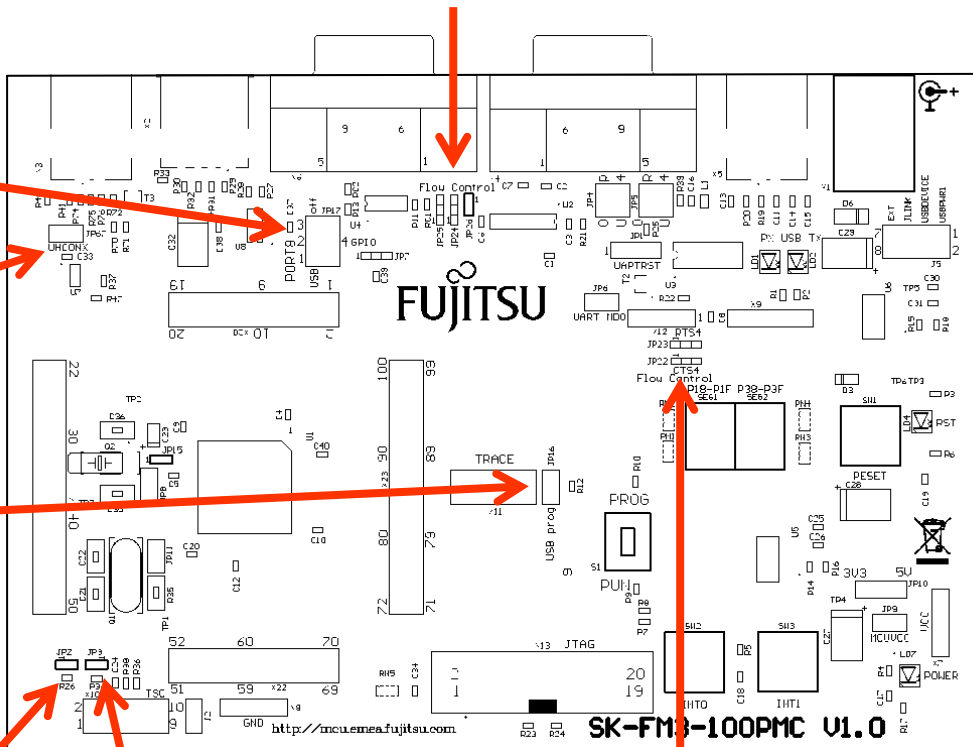



The Hardware

■ JP4, JP5 : UART selection

- UART0 and UART4 of the microcontroller can be used together with a typical RS232 SUB-D9 connector and a serial/USB converter
- The jumpers JP4 and JP5 routes the channel to the connector
- UART0 = USB-connector (X5), UART4 = Sub-D9 (X4) (default)
 - Setting of Jumper JP4 and JP5: U-0 / R-4

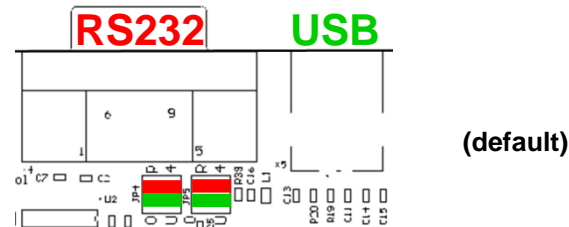

- UART0 = Sub-D9 (X4), UART4 = USB-connector (X5)
 - Setting of Jumper JP4 and JP5: U-4 / R-0

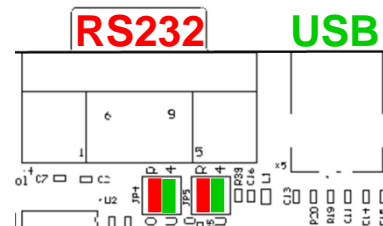



The Hardware

■ Extension headers X20-X23

- Standard 0.1" / 2.54mm grid for use with prototype boards

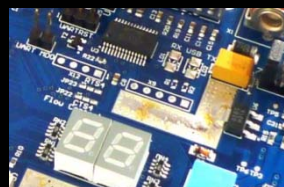

0.3" / 7.62mm

2x 15 pins
1.4" / 35.56mm

0.3" / 7.62mm

0.5" / 12.7mm

0.2" 0.7" 2x10 pins 0.4"
5.08mm 17.78mm 0.9"/22.86mm 10.16mm

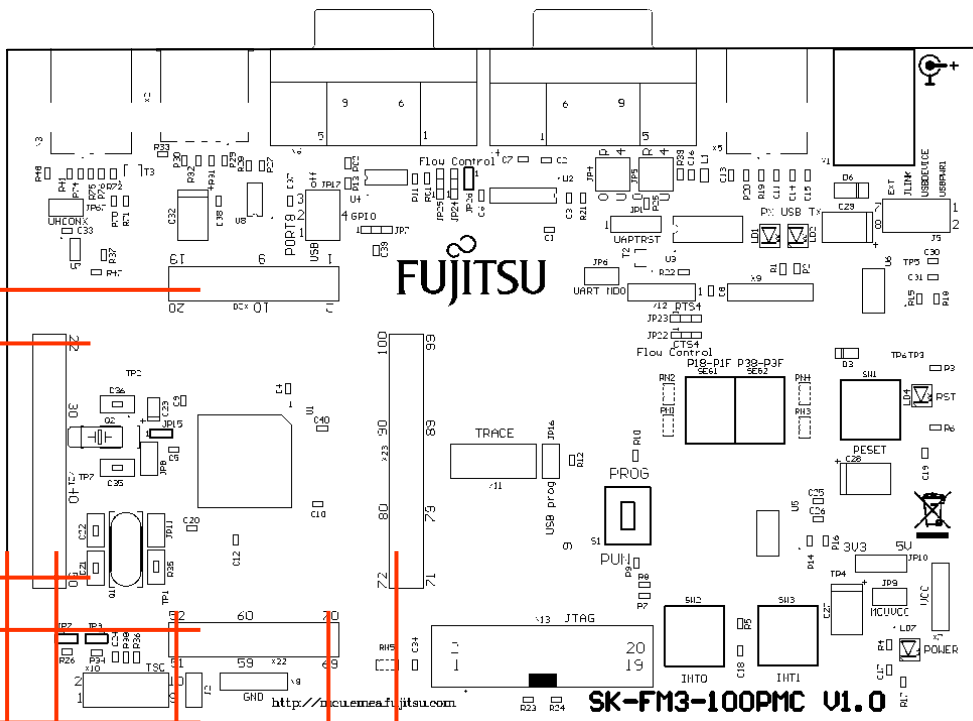



The Hardware

■ The microcontroller pins

Pin	Pin-name	Pin-Function on SK-FM-100PMC
1	VCC	MCUVCC
2	P50/INT00_0/AIN0_2/SIN3_1/RTO10_0/MDATA0	Key button 'INT0'
3	P51/INT01_0/BIN0_2/SOT3_1/RTO11_0/MDATA1	Key button 'INT1'
4	P52/INT02_0/ZIN0_2/SCK3_1/RTO12_0/MDATA2	USB current limitation 'INT2'
5	P53/SIN6_0/TIOA1_2/INT07_2/RTO13_0/MDATA3	
6	P54/SOT6_0/TIOB1_2/RTO14_0/MDATA4	
7	P55/SCK6_0/ADTG_1/RTO15_0/MDATA5	
8	P56/INT08_2/DTTI1X_0/MCSX7	
9	P30/AIN0_0/TIOB0_1/INT03_2/MDATA6	
10	P31/BIN0_0/TIOB1_1/SCK6_1/INT04_2/MDATA7	

Pin	Pin-name	Pin-Function on SK-FM-100PMC
11	P32/ZIN0_0/TIOB2_1/SOT6_1/INT05_2/M DQM0	
12	P33/INT04_0/TIOB3_1/SIN6_1/ADTG_6/M DQM1	
13	P34/FRCK0_0/TIOB4_1/TX0_1/MAD24	CAN0 TX
14	P35/IC03_0/TIOB5_1/RX0_1/INT08_1/MA D23	CAN0 RX
15	P36/IC02_0/SIN5_2/INT09_1/MCSX3	
16	P37/IC01_0/SOT5_2/INT10_1/MCSX2	
17	P38/IC00_0/SCK5_2/INT11_1	SEG2-A
18	P39/DTTI0X_0/ADTG_2	SEG2-B
19	P3A/RTO00_0/TIOA0_1	SEG2-C
20	P3B/RTO01_0/TIOA1_1	SEG2-D



The Hardware

■ The microcontroller pins (cont'd)

Pin	Pin-name	Pin-Function on SK-FM-100PMC
21	P3C/RTO02_0/TIOA2_1	SEG2-E
22	P3D/RTO03_0/TIOA3_1	SEG2-F
23	P3E/RTO04_0/TIOA4_1	SEG2-G
24	P3F/RTO05_0/TIOA5_1	SEG2-DP
25	VSS	GND
26	VCC	MCUVCC
27	P40/TIOA0_0/RTO10_1/INT12_1/MAD22	TINT TSC-Connector 'INT12'
28	P41/TIOA1_0/RTO11_1/INT13_1/MAD21	GINT TSC-Connector 'INT13'
29	P42/TIOA2_0/RTO12_1/MAD20	
30	P43/TIOA3_0/RTO13_1/ADTG_7/MAD19	

Pin	Pin-name	Pin-Function on SK-FM-100PMC
31	P44/TIOA4_0/RTO14_1/MAD18	
32	P45/TIOA5_0/RTO15_1/MAD17	
33	C	'C' capacitor
34	VSS	GND
35	VCC	MCUVCC
36	P46/X0A	Subclock (optional)
37	P47/X1A	Subclock (optional)
38	INITX	Key button ,Reset'
39	P48/DTT11X_1/INT14_1/SIN3_2/MAD16	
40	P49/TIOB0_0/IC10_1/AIN0_1/SOT3_2/MA D15	SDA3 TSC-Connector



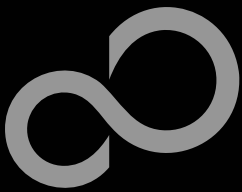

The Hardware

■ The microcontroller pins (cont'd)

Pin	Pin-name	Pin-Function on SK-FM-100PMC
41	P4A/TIOB1_0/IC11_1/BIN0_1/SCK3_2/MAD14	SCL3 TSC-Connector
42	P4B/TIOB2_0/IC12_1/ZIN0_1/MAD13	
43	P4C/TIOB3_0/IC13_1/SCK7_1/AIN1_2/MAD12	
44	P4D/TIOB4_0/FRCK1_1/SOT7_1/BIN1_2/MAD11	
45	P4E/TIOB5_0/INT06_2/SIN7_1/ZIN1_2/MAD101	
46	MD1	GND
47	MD0	Mode-Switch S1
48	X0	4 MHz Crystal
49	X1	4 MHz Crystal
50	VSS	GND

Pin	Pin-name	Pin-Function on SK-FM-100PMC
51	VCC	MCUVCC
52	P10/AN00	
53	P11/AN01/SIN1_1/INT02_1/RX1_2	
54	P12/AN02/SOT1_1/TX1_2/MAD09	
55	P13/AN03/SCK1_1/MAD08	
56	P14/AN04/SIN0_1/INT03_1/MCSX1	
57	P15/AN05/SOT0_1/MCSX0	
58	P16/AN06/SCK0_1/MOEX	
59	P17/AN07/SIN2_2/INT04_1/MWEX	
60	AVCC	MCUVCC

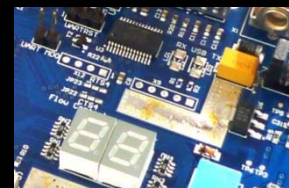



The Hardware

■ The microcontroller pins (cont'd)

Pin	Pin-name	Pin-Function on SK-FM-100PMC
61	AVRH	MCUVCC
62	AVSS	GND
63	P18/AN08/SOT2_2/MDATA8	SEG1-A
64	P19/AN09/SCK2_2/MDATA9	SEG1-B
65	P1A/AN10/SIN4_1/INT05_1/IC00_1/MDATA10	SEG1-C
66	P1B/AN11/SOT4_1/IC01_1/MDATA11	SEG1-D
67	P1C/AN12/SCK4_1/IC02_1/MDATA12	SEG1-E
68	P1D/AN13/CTS4_1/IC03_1/MDATA13	SEG1-F
69	P1E/AN14/RTS4_1/DTTIOX_1/MDATA14	SEG1-G
70	P1F/AN15/ADTG_5/FRCK0_1/MDATA15	SEG1-DP

Pin	Pin-name	Pin-Function on SK-FM-100PMC
71	P23/SCK0_0/TIOA7_1/RTO00_1	
72	P22/SOT0_0/TIOB7_1/ZIN1_1	UART0 (TXD)
73	P21/SIN0_0/INT06_1/BIN1_1	UART0 (RXD)
74	P20/INT05_0/CROUT/AIN1_1	Reset TSC-Connector
75	VSS	GND
76	VCC	MCUVCC
77	P00/TRSTX	JTAG TRSTX
78	P01/TCK/SWCLK	JTAG/TRACE TCK
79	P02/TDI	JTAG/TRACE TDI
80	P03/TMS/SWDIO	JTAG/TRACE TMS





The Hardware

■ The microcontroller pins (cont'd)

Pin	Pin-name	Pin-Function on SK-FM-100PMC
81	P04/TDO/SWO	JTAG/TRACE TDO
82	P05/TRACED0/TIOA5_2/SIN4_2/INT00_1	TRACE TRACED0
83	P06/TRACED1/TIOB5_2/SOT4_2/INT01_1	TRACE TRACED1
84	P07/TRACED2/ADTG_0/SCK4_2	TRACE TRACED2
85	P08/TRACED3/TIOA0_2/CTS4_2	TRACE TRACED3
86	P09/TRACECLK/TIOB0_2/RTS4_2	TRACE TRACECLK
87	P0A/SIN4_0/INT00_2/FRCK1_0/MAD07	UART4 (RXD)
88	P0B/SOT4_0/TIOB6_1/IC10_0/MAD06	UART4 (TXD)
89	P0C/SCK4_0/TIOA6_1/IC11_0/MAD05	
90	P0D/RTS4_0/TIOA3_2/IC12_0/MAD04	RTS4 Flow control

Pin	Pin-name	Pin-Function on SK-FM-100PMC
91	P0E/CTS4_0/TIOB3_2/IC13_0/MAD03	CTS4 Flow control
92	P0F/NMIX/MAD02	
93	P63/INT03_0/SIN5_1/RX0_2/MAD01	USB-Switch Device/Host
94	P62/SCK5_0/ADTG_3/TX0_2/MAD00	Current limitation enable
95	P61/SOT5_0/TIOB2_2/UHCONX	USB UHCONX
96	P60/SIN5_0/TIOA2_2/INT15_1	Mode-Switch S1
97	USBVCC	USB-power supply
98	P80/UDM0	USB Data-
99	P81/UDP0	USB Data+
100	VSS	GND

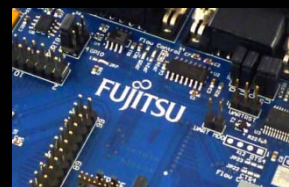
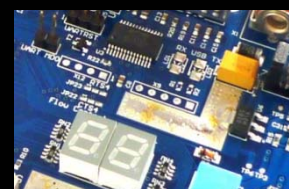



The Software

■ The SK-FM3-100PMC CD includes the following software:

- MCU Flash programming tools
 - FUJITSU FLASH MCU Programmer for FM3
 - FLASH USB DIRECT Programmer
- USB driver for on-board USB-to-RS232 converter
- The terminal program SKwizard
- Software examples for the SK-FM3-100PMC

■ Please check our dedicated microcontroller website:

<http://mcu.emea.fujitsu.com>

- for updates of the Flash programmer tool, utilities and examples
- for data sheets, hardware manuals, application notes, etc.



Installation of the USB-driver

■ Connect the SK-FM3-100PMC via USB (X5) to your PC

- Windows will 'Found New Hardware: SK-FM3-100PMC' and the Hardware Wizard should start automatically
 - **Note: The installation procedure may differ with different operating systems**

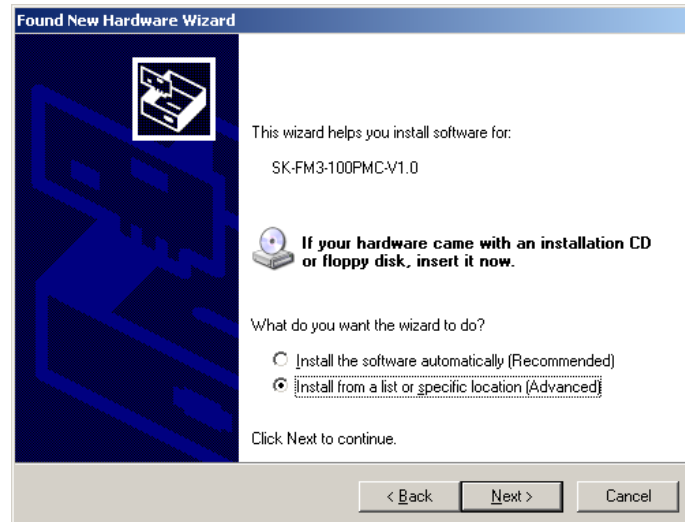

- Do not connect to Windows Update to search for software
- Select 'Install from a list or specific location (Advanced)'
- Within next windows select 'Search for the best driver' and browse on the CD to the folder 'drive:\USB-Driver\Win2000_WinXP_Vista_Windows7_Fujitsu'

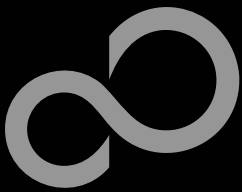

Installation of the USB-driver

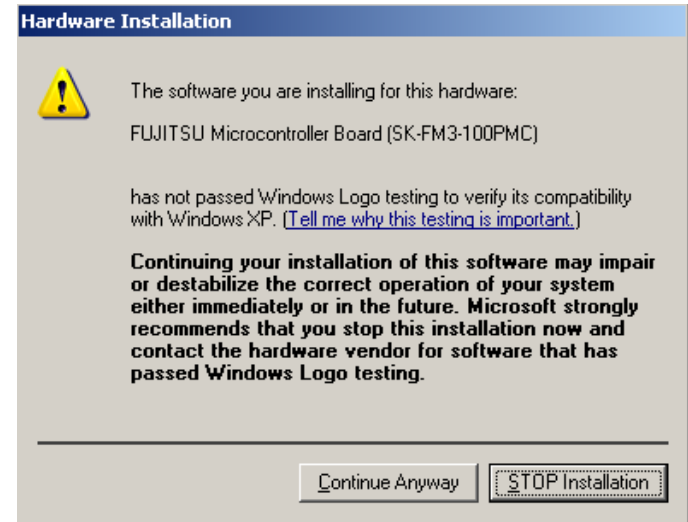
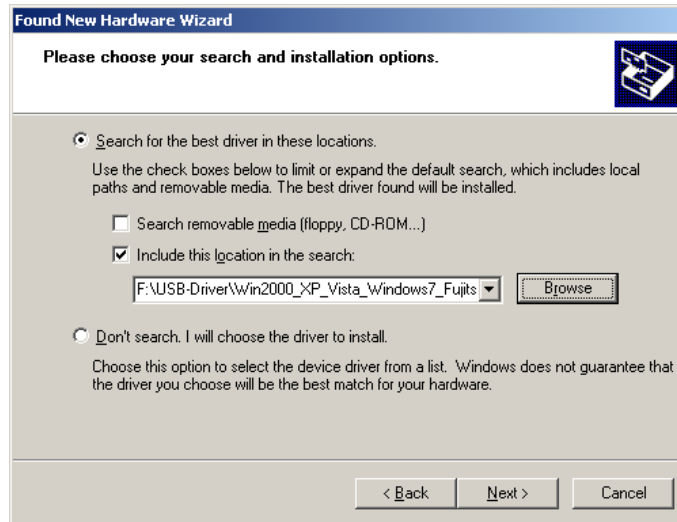

- 'Continue anyway' although the Windows Logo test may not be passed
- Windows completes the installation by copying some files
- 'Finish' will close the window





Installation of the USB-driver

- Again Windows will 'Found New Hardware: USB Serial Port' and the Hardware Wizard should start automatically
 - **Note:** The installation procedure may differ with different operating systems

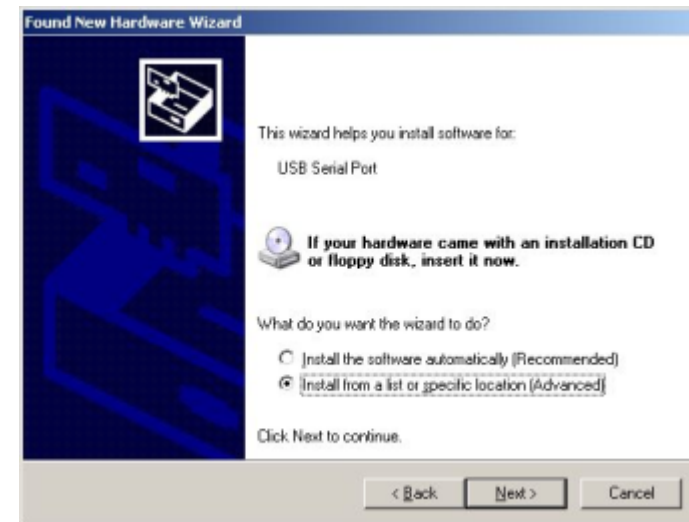

- Do not connect to Windows Update to search for software
- Select 'Install from a list or specific location (Advanced)'
- Within next windows select 'Search for the best driver' and browse on the CD to the folder 'drive:\ USB-Driver\Win2000_WinXP_Vista_Windows7_Fujitsu'



Installation of the USB-driver

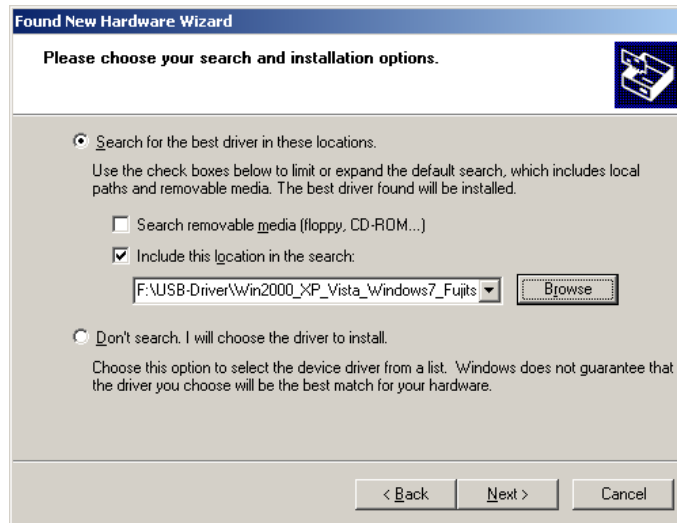

- 'Continue anyway' although the Windows Logo test may not be passed
- Windows completes the installation by copying some files

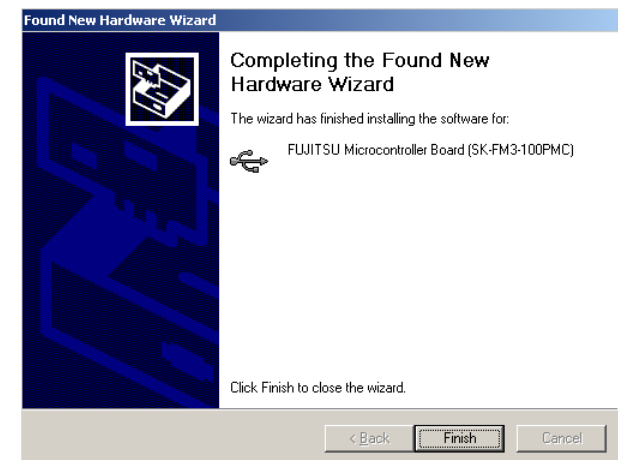

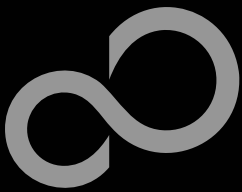

Installation of the USB-driver

- **Start the Device Manager of the Windows Control Panel**
 - START -> Settings -> Control Panel
 - Control Panel -> System -> Hardware -> Device Manager
- **Check 'Ports' for the assigned virtual COM-port number**
 - FUJITSU Microcontroller board (e.g.: COM3)

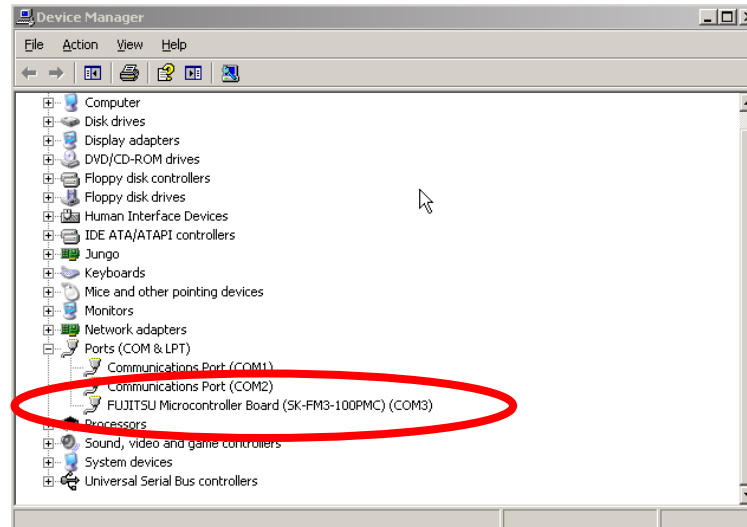

- **Ready!**



Tools and Software Examples

■ SKwizard

- Free of charge terminal program
- [Start installation](#)

■ Following examples are provided with SK-FM3-100PMC for IAR Embedded Workbench V6 and KEIL μ Vision4:

- [mb9bf506n template](#)
 - ,Empty' project as base for user applications
- [mb9bfxxx adc dvm](#)
 - Digital Voltage Meter based on the A/D-converter
- [mb9bfxxx can uart terminal](#)
 - Simple CAN example (CAN0)
- [mb9bfxxx ioport counter](#)
 - Counts from 0 to 99 on the 7-segment Display

Further examples on CD [Examples](#) and on our website

Note:

Please copy the examples to your local drive!



Flash Programming

■ There are two options to program the flash:

1. UART Programming (X4, X5)

- Check jumper JP16 is opened
- Connect UART0 of the board to the USB-Port of the PC
 - via USB (JP4,JP5: U-0, R-4)
 - via RS232 (JP4,JP5: U-4, R-0)
- Use the [FUJITSU FLASH MCU Programmer](#)

2. USB Programming (X3)

- Check jumper JP16 is closed
- Connect the board via USB-Device (X3) to the USB-Port of the PC
- Use the [FLASH USB DIRECT Programmer](#)

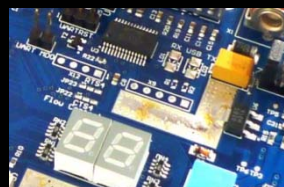

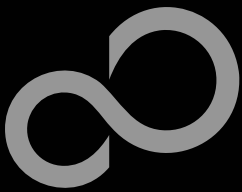

FUJITSU FLASH MCU Programmer for UART Programming

■ FUJITSU FLASH MCU Programmer

- Free of charge, no registration required
- Windows based programming tool for FM3 Fujitsu microcontroller
- Uses PC serial port COMx (incl. virtual COM port: USB-to-RS232)
- [Start installation](#)

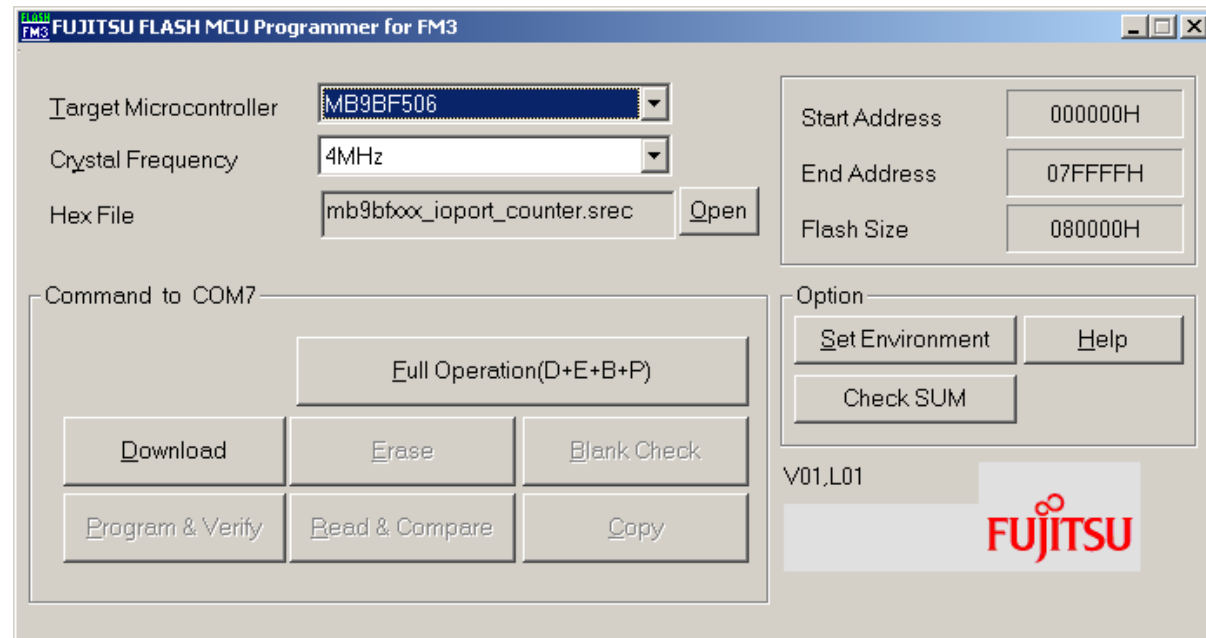



Program Download

- Start the FUJITSU FLASH MCU Programmer
- Select the target microcontroller (MB9BF506)
- Select the crystal frequency (4 MHz)
- Choose the software example from the example 'exe'-folder (e.g. Examples\mb9bfxxx_ioport_counter-vxx10\example\IAR\output\release\exe\mb9bfxxx_ioport_counter.srec)

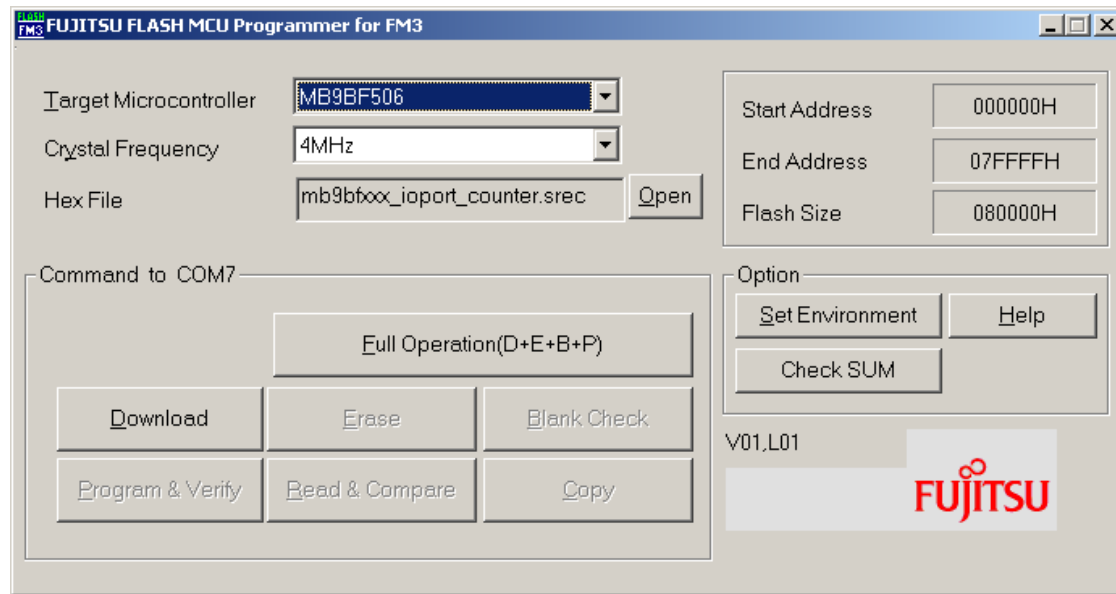
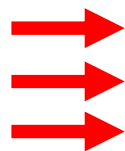

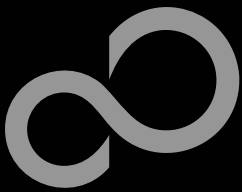

Program Download

■ Connect to the PC

- Connect UART0 with RS232 (X4) or with the USB interface X5
- Select COM port (,Set Environment')

(see JP4, JP5 jumper settings)

RS232 USB port

■ Open JP16

■ Set switch S1 to position ,PROG'

■ Press ,Reset'

■ Start ,Full Operation'

S1: Mode selection

PROG: Set switch to position ,PROG' in order to select the program-mode

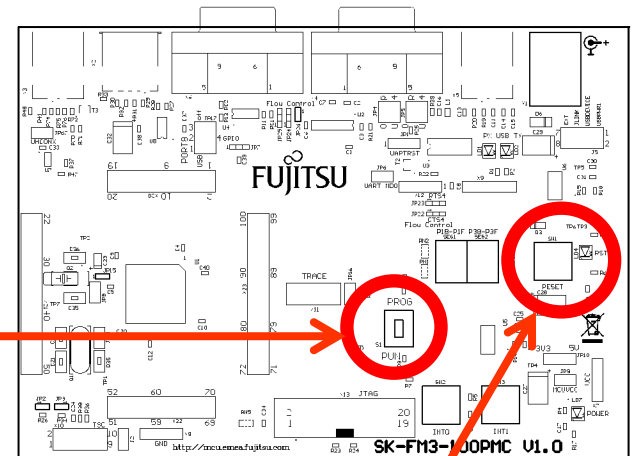

Keybutton ,RESET'

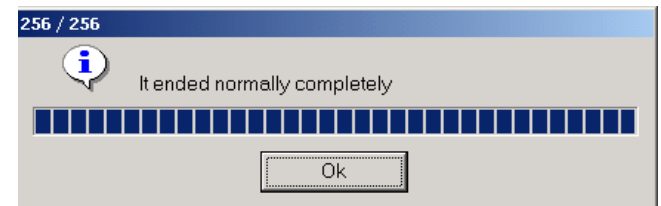
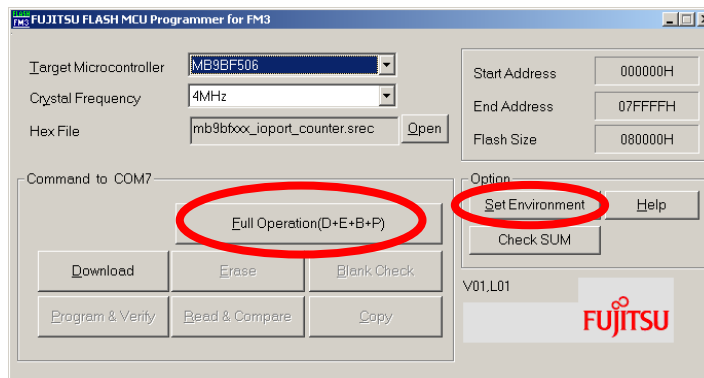



Program Download

- Close the FUJITSU FLASH MCU Programmer
- Set switch S1 to position ,RUN‘
- Press ,Reset‘

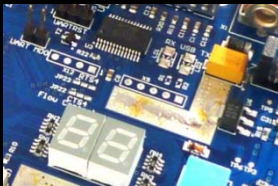

S1: Mode selection

**RUN: Set switch to position ,RUN‘
in order to select the run-mode**

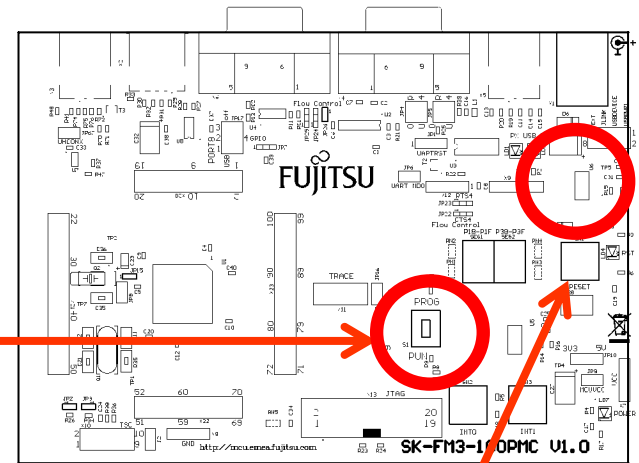

Keybutton ,RESET‘

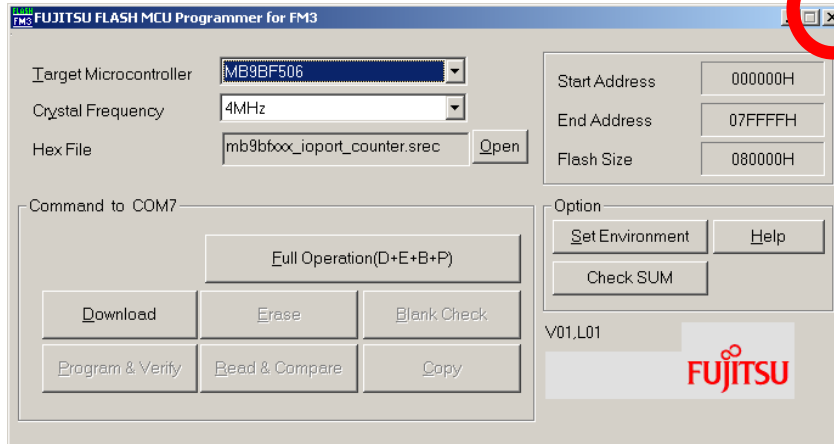

**Close the FUJITSU FLASH
MCU Programmer**



FLASH USB DIRECT Programmer for USB Direct Programming

■ FLASH USB DIRECT Programmer

- Windows based programming tool for FM3 Fujitsu microcontroller
- Uses direct USB connection (via X3)
- [Start installation](#)

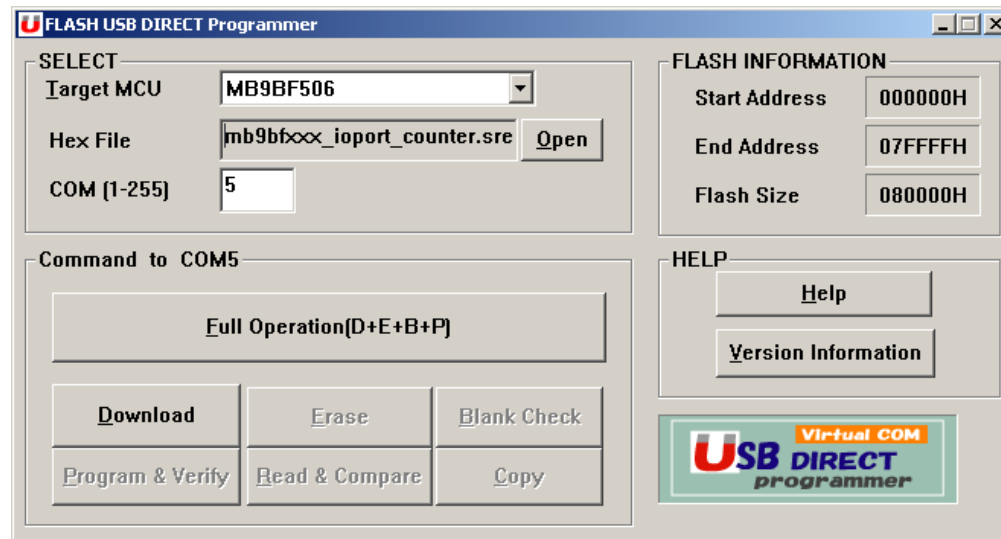

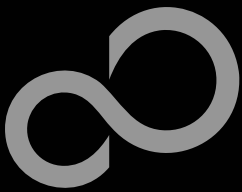

Program Download

- Start the FLASH USB DIRECT Programmer
- Select the target microcontroller (MB9BF506)
- Choose the software example from the example 'exe'-folder (e.g. Examples\mb9bfxxx_ioport_counter-v10\example\IAR\output\release\exe\mb9bfxxx_ioport_counter.srec)
- Select the COM port

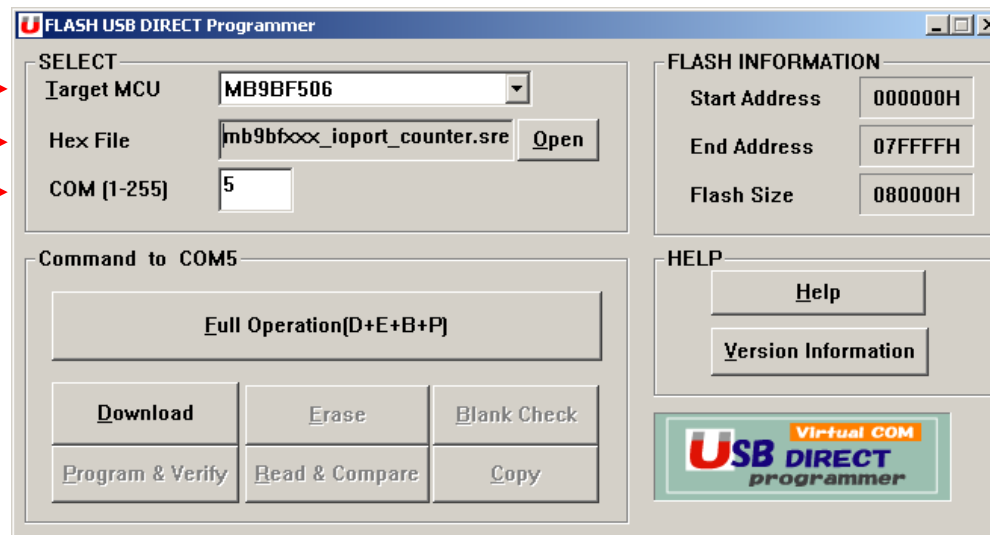



Program Download

- Select the MCU power supply (J5)
- Close JP16
- Set switch S1 to position ,PROG‘
- Connect USB port X3 with the PC
- Install the USB driver
 - See subfolder ,driver‘ of installed programmer
 - E.g.: C:\FUJITSU USB DIRECT Programmer
- Press ,Reset‘
- Start ,Full Operation‘

USB port X3

J5

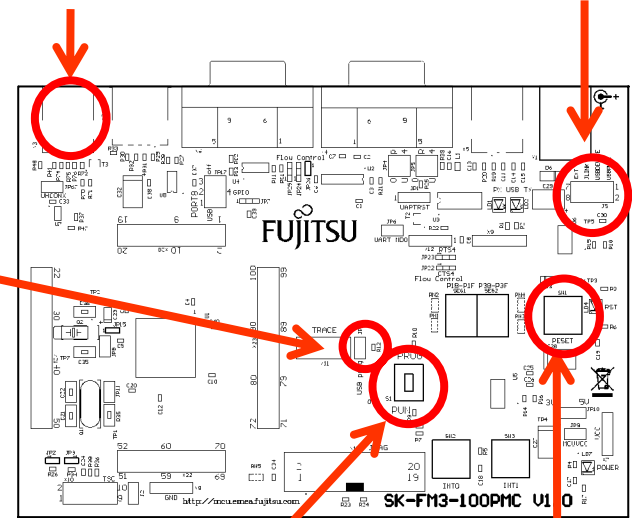

JP16

S1: Mode selection

PROG: Set switch to position ,PROG‘ in order to select the program-mode

Keybutton ,RESET‘

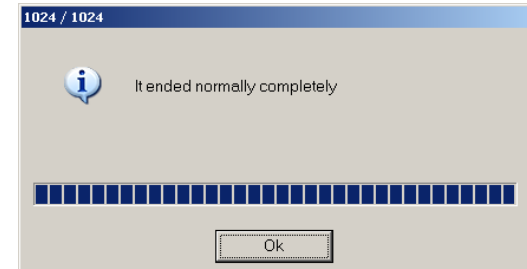
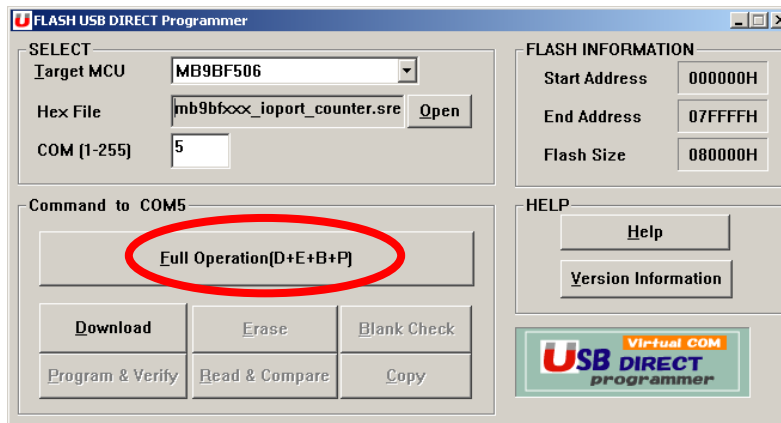

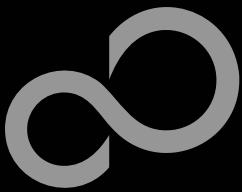

Program Download

- Close the FLASH USB DIRECT Programmer
- Set switch S1 to position ,RUN'
- Press ,Reset'

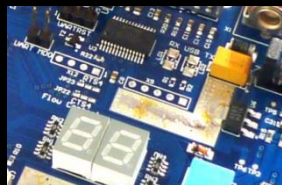

S1: Mode selection

RUN: Set switch to position ,RUN' in order to select the run-mode

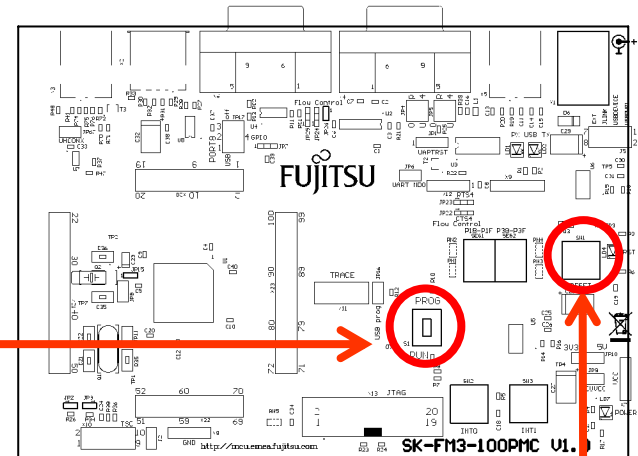

Keybutton ,RESET'

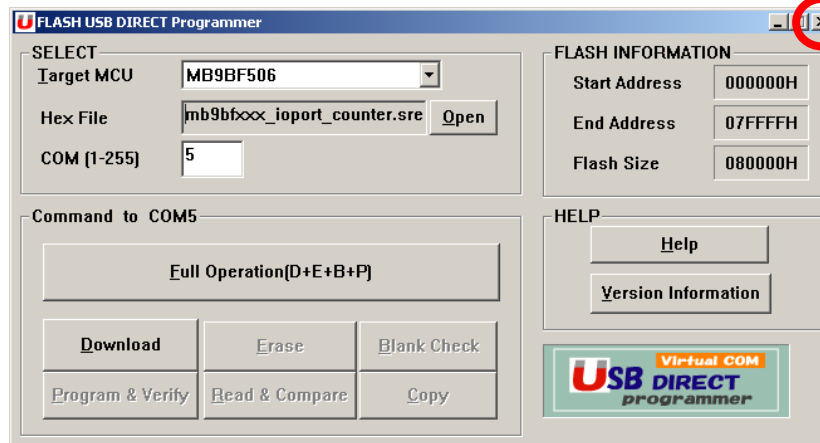

Close the FLASH USB DIRECT Programmer



Debugging via JTAG

■ The MB9BF506N microcontroller offers a JTAG-Interface that is supported by SK-FM3-100PMC.

- Debug your program with a JTAG-Adapter e.g. Segger J-Link
- Connect the J-Link to the JTAG-Interface routed to the 20-Pin-Header on X13 and to the USB-Port of your PC
- Use IAR-Embedded Workbench to debug your program
- If the JTAG-Adapter allows powering the target, then jumper J5 can be set as follows:

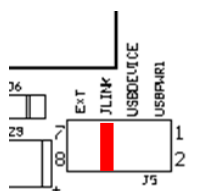



Debugging via TRACE

- The MB9BF506N microcontroller offers an ETM (Embedded-Trace-Macrocell) that is supported by SK-FM3-100PMC
 - An optional JTAG-Adapter supporting trace features is required e.g. **ULINKpro** from KEIL
 - The ETM is connected to the 20-Pin-Header X11 (TRACE)
 - Use e.g. KEIL μ Vision to trace your program

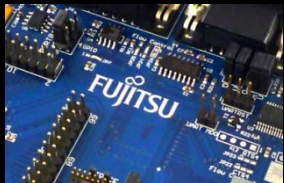
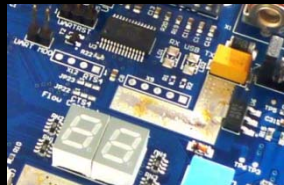

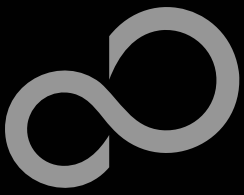

IAR-Embedded Workbench / KEIL μ Vision IDE and Debugger

- Installation
- Getting Started
- Open Project
- Build Project
- Debug Project

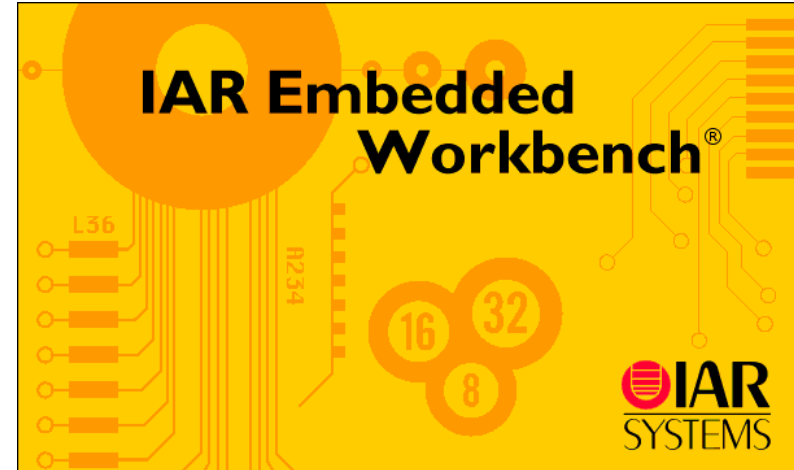



IAR Workbench Getting Started

■ Install EWARM from IAR-CD or download latest version from IAR Website

- EWARM 30-day Evaluation Version
 - <http://supp.iar.com/Download/SW/?item=EWARM-EVAL>
- EWARM 32K Kickstart Version
 - <http://supp.iar.com/Download/SW/?item=EWARM-KS32>

■ Install J-Link Debugger (SK-FM3-100PMC-JLINK)

- Connect J-Link to USB Port and follow installation instructions
 - Drivers:
`<Installation_Path>\IAR Systems\Embedded Workbench
x.y\arm\drivers\Jlink\ x64 or x86`

■ Start EWARM Workbench

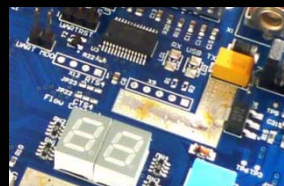



IAR Workbench Getting Started

- Choose **File** → **Open** → **Workspace**
- Select e.g. `\Examples\mb9bfxxx_ioport_counter-vxx\example\IAR\mb9bfxxx_ioport_counter.eww`

The screenshot shows the IAR Embedded Workbench IDE interface. The 'File' menu is open, with 'Open' selected, and the 'Workspace...' option is highlighted. Below the menu is a yellow banner for the 'Information Center for ARM' with the text 'Information you need to get started: tutorials, example projects, reference guides, support information, and release notes.' Below the banner is a grid of six resource cards:

- GETTING STARTED**: Guidelines for setting up your project, adding files, compiling, linking, and debugging it.
- USER GUIDES**: Complete product documentation in PDF format gives you all the user and reference information you need.
- EXAMPLE PROJECTS**: Example applications that demonstrate hardware peripherals for specific devices and evaluation boards.
- TUTORIALS**: Tutorials to make you familiar with the IDE and the features of the IAR C-SPY debugger.
- SUPPORT**: For questions about how to use your IAR product, reporting a problem, or finding support resources.
- RELEASE NOTES**: Read about the latest features, new device support and bug fixes in the release notes.

Additional links are provided: www.iar.com/resources and www.iar.com/mypages.

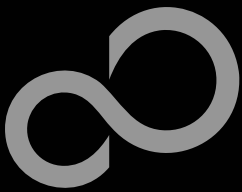

IAR Workbench – Main Window

■ IAR Workbench

- Workspace on left side of Workbench window
 - Choose:
View→Workspace,
if hidden
- Source files on right side of Workbench window as tabbed windows
- Project can alternatively be opened by:
File→Open→Workspace→.eww*

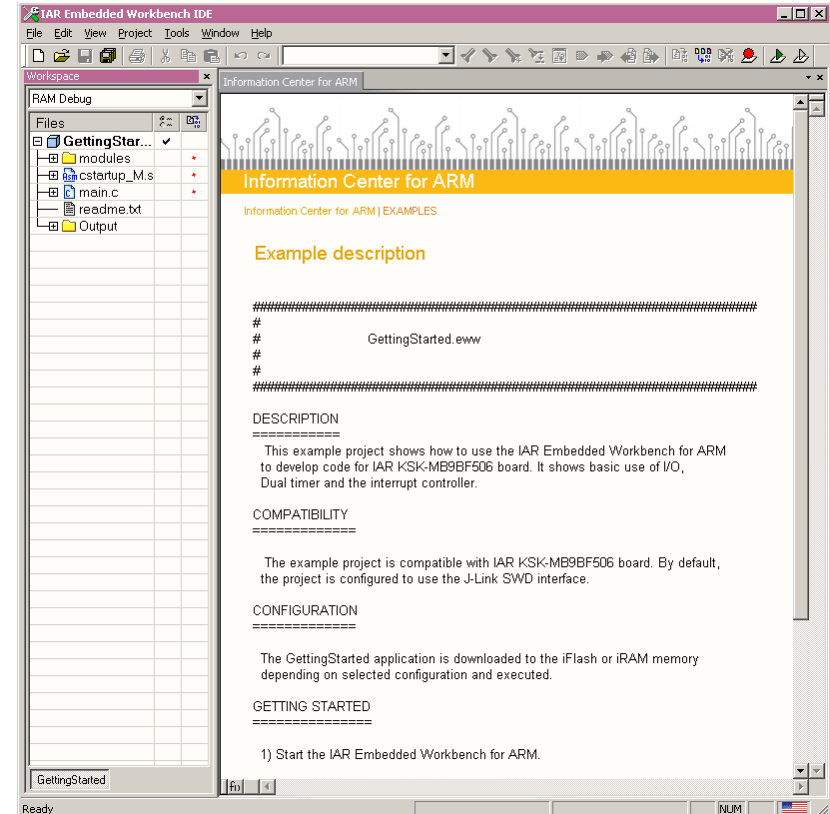



IAR Workbench - Menu Bar

■ Menu Bar

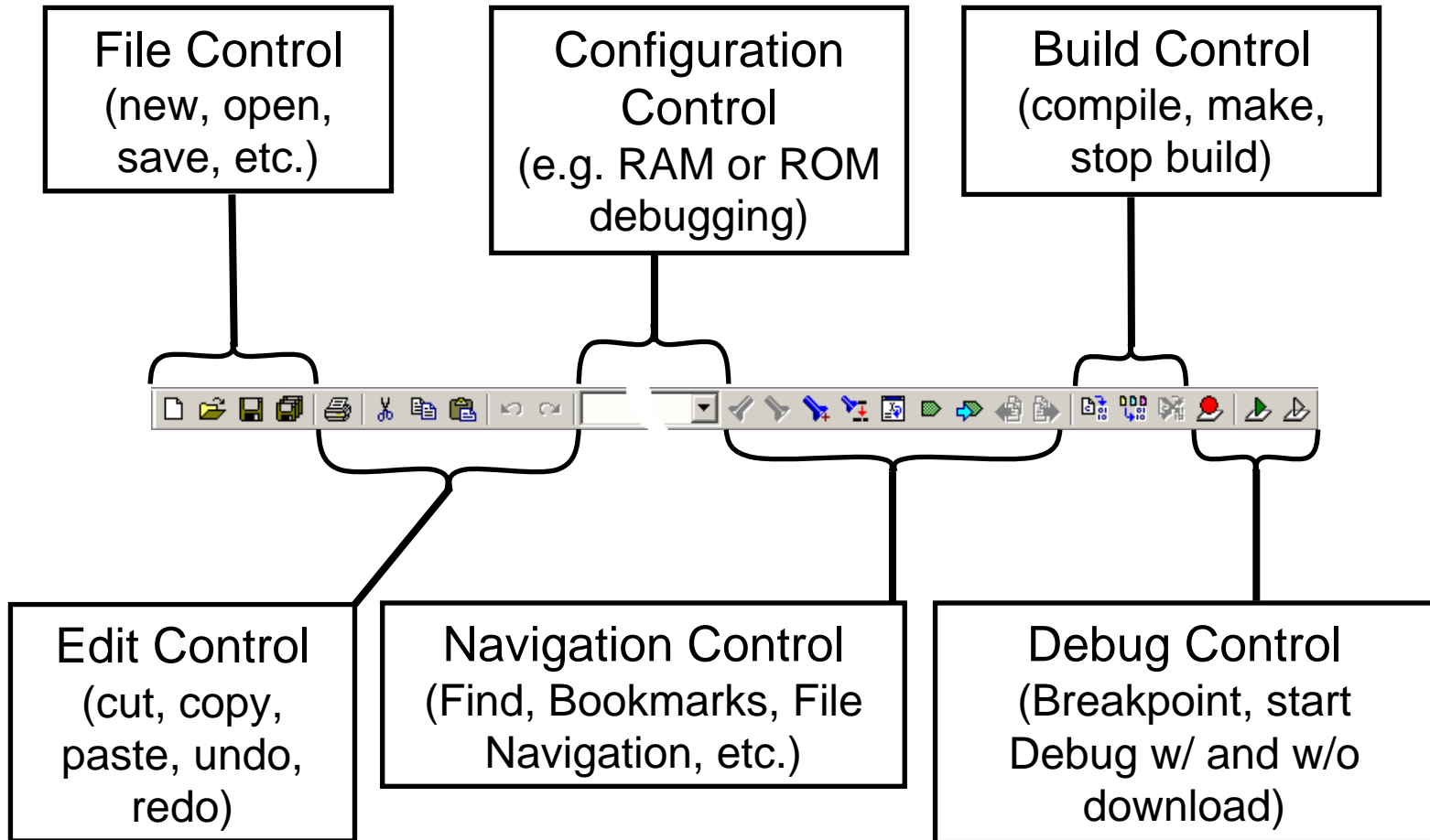

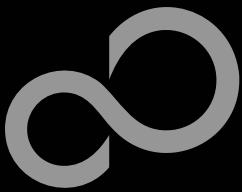

IAR Workbench - Workspace

■ IAR Workspace Window

Project Name

Sub Folder Modules

Main Modules

Module Includes

Project Description

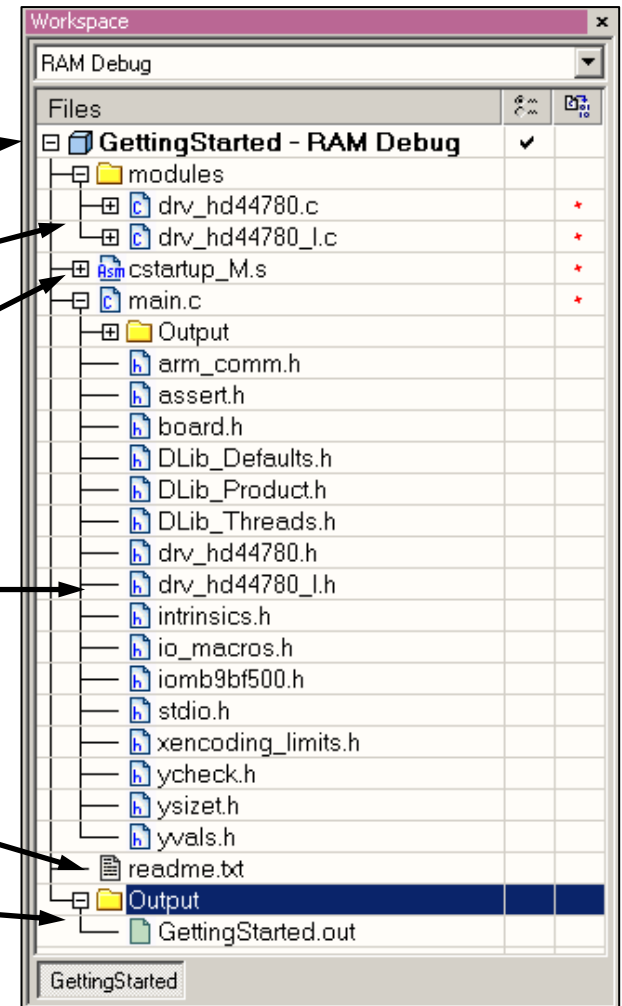

Project Built Output





IAR Workbench – Making Project

■ Making the Project

- Use Make-Icon () , <F7> or Menu: *Project*→*Make*
- Check for no errors in Output window below
- Build errors are indicated by  or 
In Output window and Source view

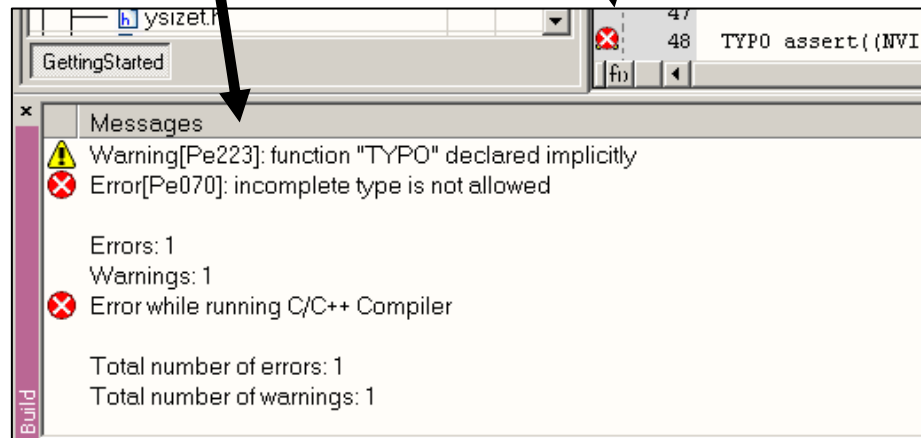
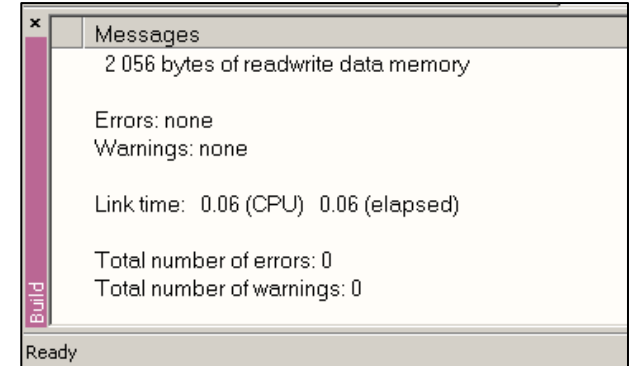



IAR Workbench - Download to Target

■ Download to Target and Start Debugging

- Use  Icon, <Ctrl>-D, or *Project*→*Download and Debug*
- A new menu bar will occur on successful connection to target

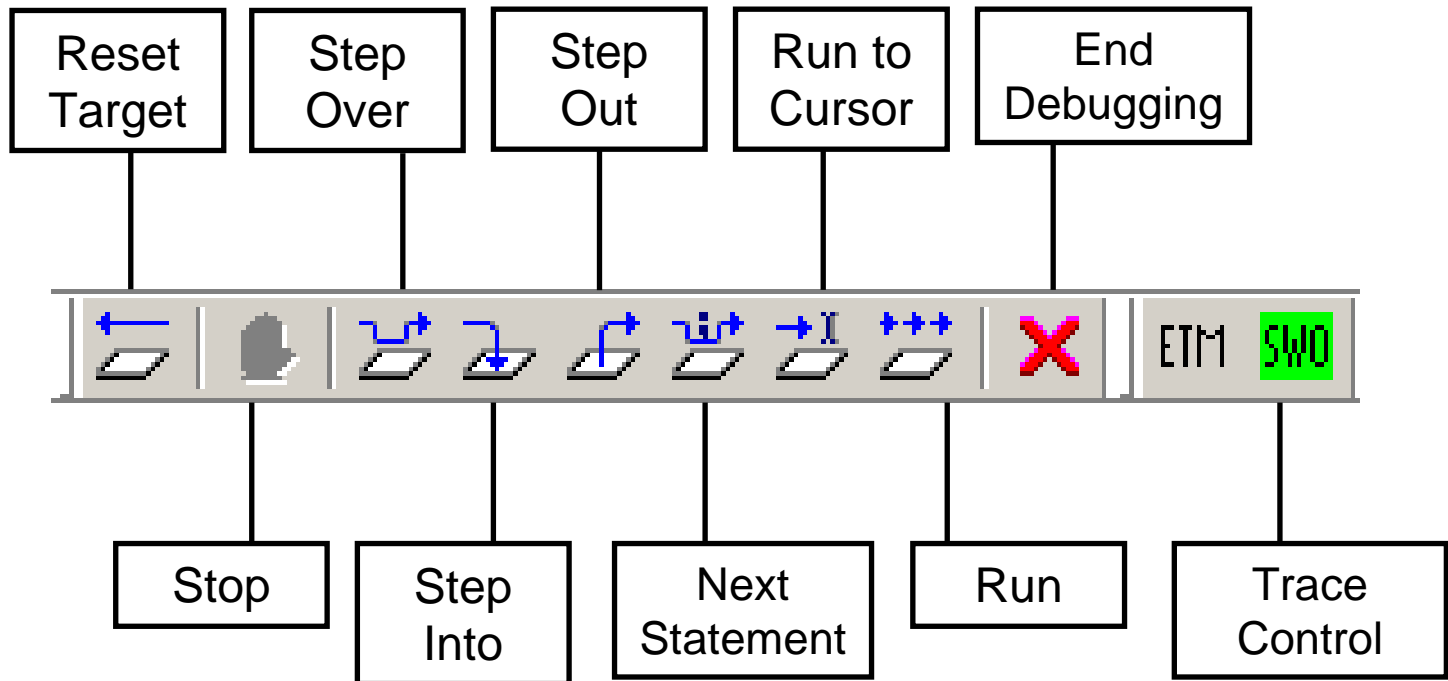

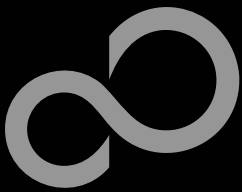



IAR Workbench – Debug (1)

■ Source Window

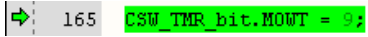
- The Source windows do not change contents but get additional information

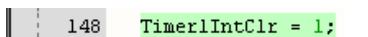
- Current line (PC): 
- Halted on Breakpoint: 
- Halted on Data break (example): 

■ Disassembly Window

- Shows ‘pure’ disassembly view
- Shows mixed mode view

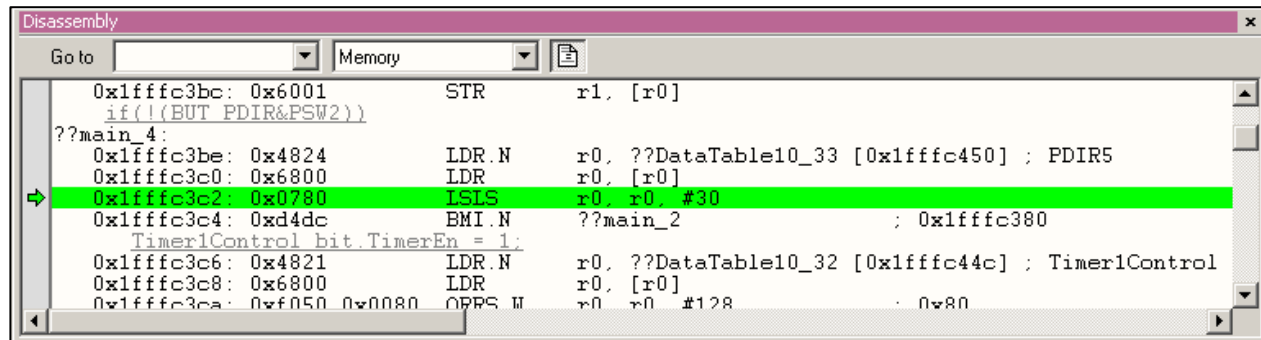

```
Disassembly
Goto [ ] Memory [ ]
0x1fff3bc: 0x6001 STR r1, [r0]
    if(! (BUT_PDIR&PSW2))
??main_4:
0x1fff3be: 0x4824 LDR.N r0, ??DataTable10_33 [0x1fff450] ; PDIR5
0x1fff3c0: 0x6800 LDR r0, [r0]
→ 0x1fff3c2: 0x0780 LSLS r0, r0, #30
0x1fff3c4: 0xd4dc BMI.N ??main_2 ; 0x1fff380
    Timer1Control_bit.TimerEn = 1;
0x1fff3c6: 0x4821 LDR.N r0, ??DataTable10_32 [0x1fff44c] ; Timer1Control
0x1fff3c8: 0x6800 LDR r0, [r0]
0x1fff3ca: 0xf050 0x0080 ORRS.W r0, r0, #128 ; 0x80
```



IAR Workbench – Debug (2)

■ Watch Window

- Watch
 - Expressions/Variables have to be added by user and are updated by Halt/Breakpoint

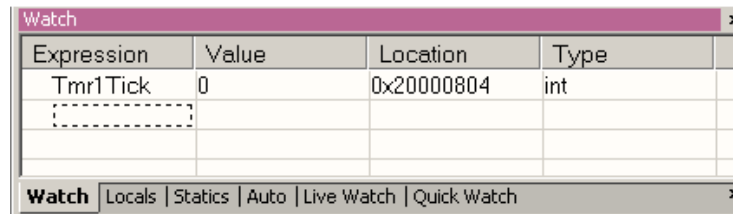

- Quick Watch
 - The Quick watch allows the user to calculate and recalculate expressions even with variables

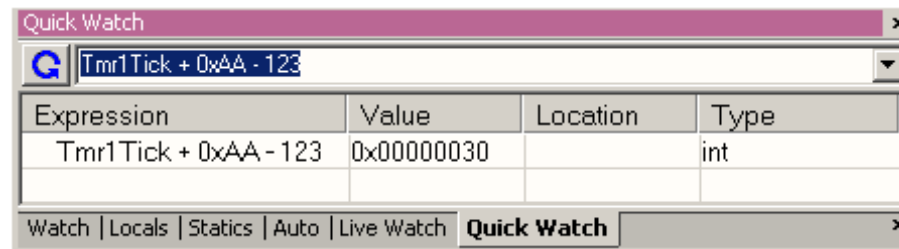

- The drop down menu memorizes the last typed contents



IAR Workbench – Simulator

■ Simulator

- Mark Project File in Workspace
- Choose *Project*→*Options*
- Choose Simulator in Debugger Setup
- Start Simulator with usual  Icon

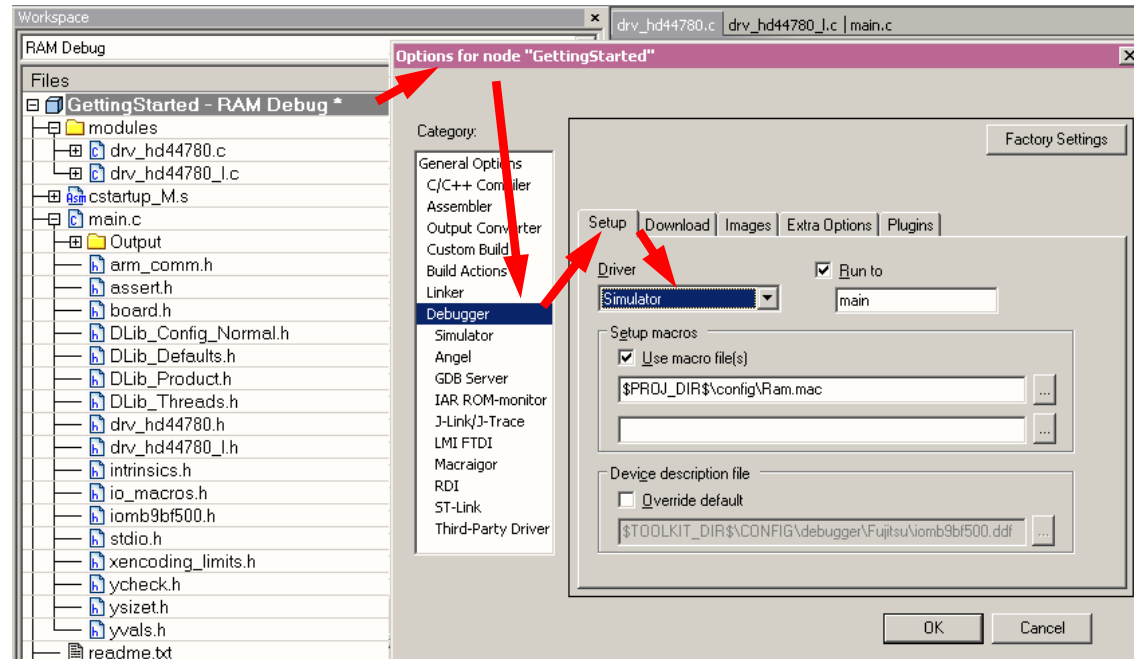

KEIL μ Vision IDE and Debugger Getting Started

■ Install μ Vision from KEIL-CD or download latest version from KEIL Website

- Evaluation Version
 - <https://www.keil.com/demo/eval/arm.htm>
 - Registration required

■ Install ULINK-ME

- Special installation is not needed, because ULINK-ME acts as a USB Human Interface Device (HID) and thus needs no extra USB driver

■ Install ULINK Pro (optional)

- ULINK Pro needs an own dedicated USB driver located in:
<Installation Path>\KEIL\ARM\ULINK

■ Start μ Vision



KEIL μ Vision – Getting Started

■ Choose Menu: **Project**→**Open Project...**

- Browse to: Examples\mb9bfxxx_ioport_counter-v10\example\ARM\
- Choose *mb9bfxxx_ioport_counter.uvproj*

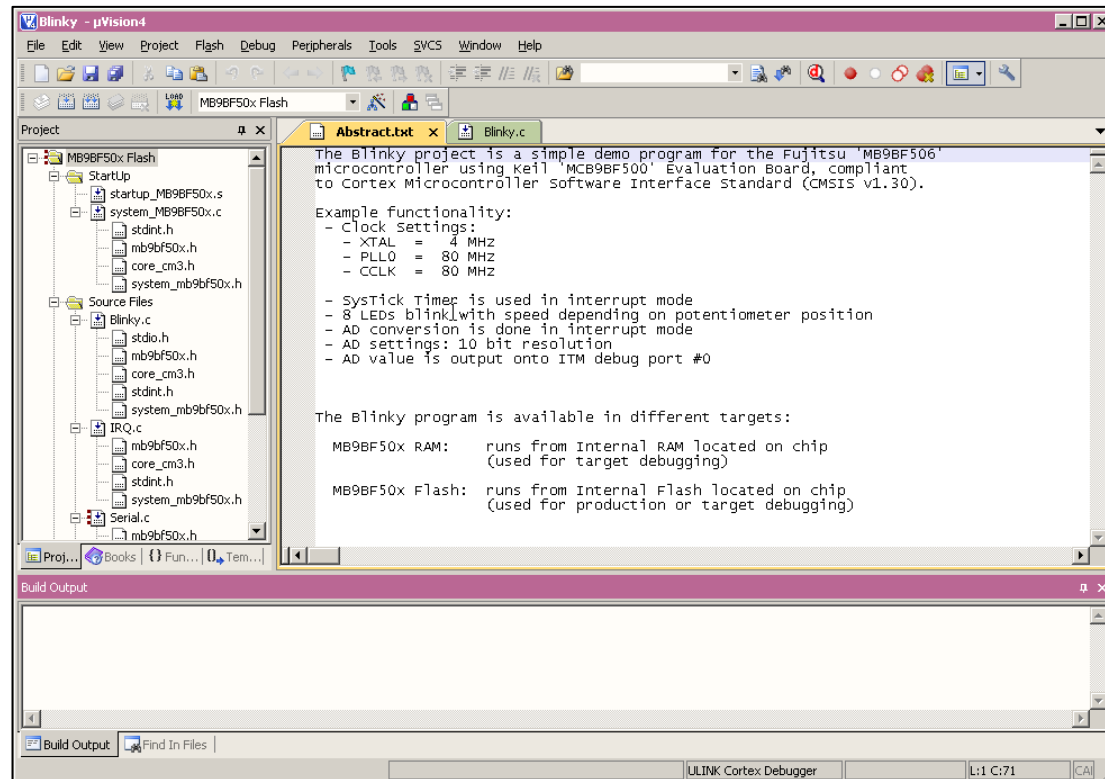

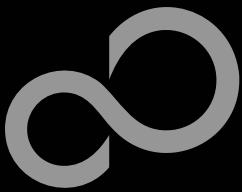

KEIL μ Vision – Main Window

■ KEIL μ Vision

- Project window on left side of IDE window
 - Choose:
View→*Project Window*
if hidden
- Source files on right side of IDE window as tabbed windows
- Output window on bottom side of IDE window

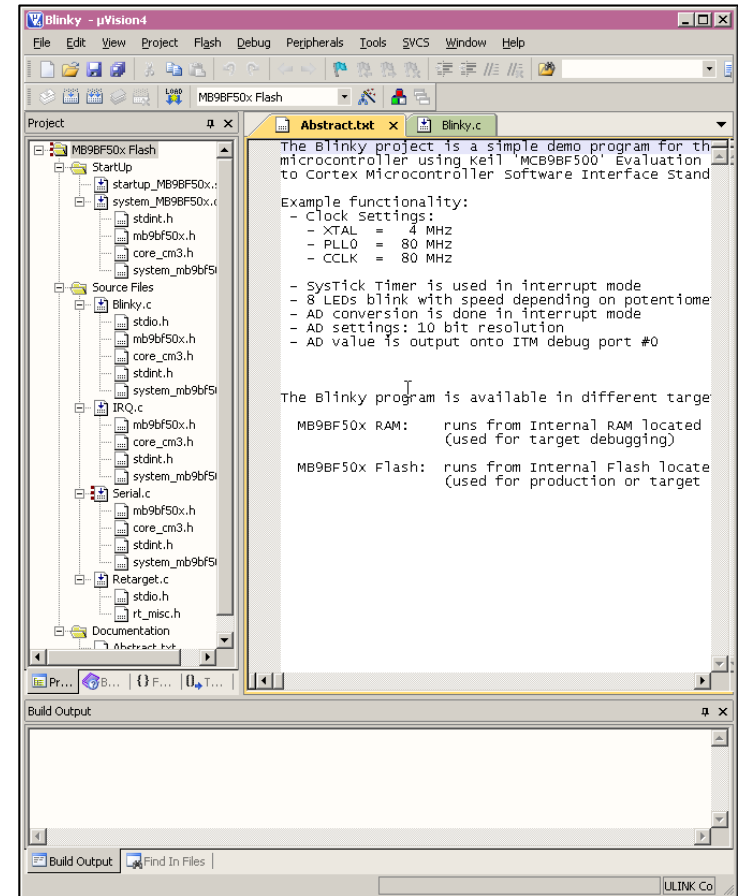

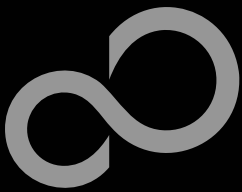

KEIL μ Vision – Menu Bars (1)

■ Menu Bar 1

- Can be moved in bar window area or set floating

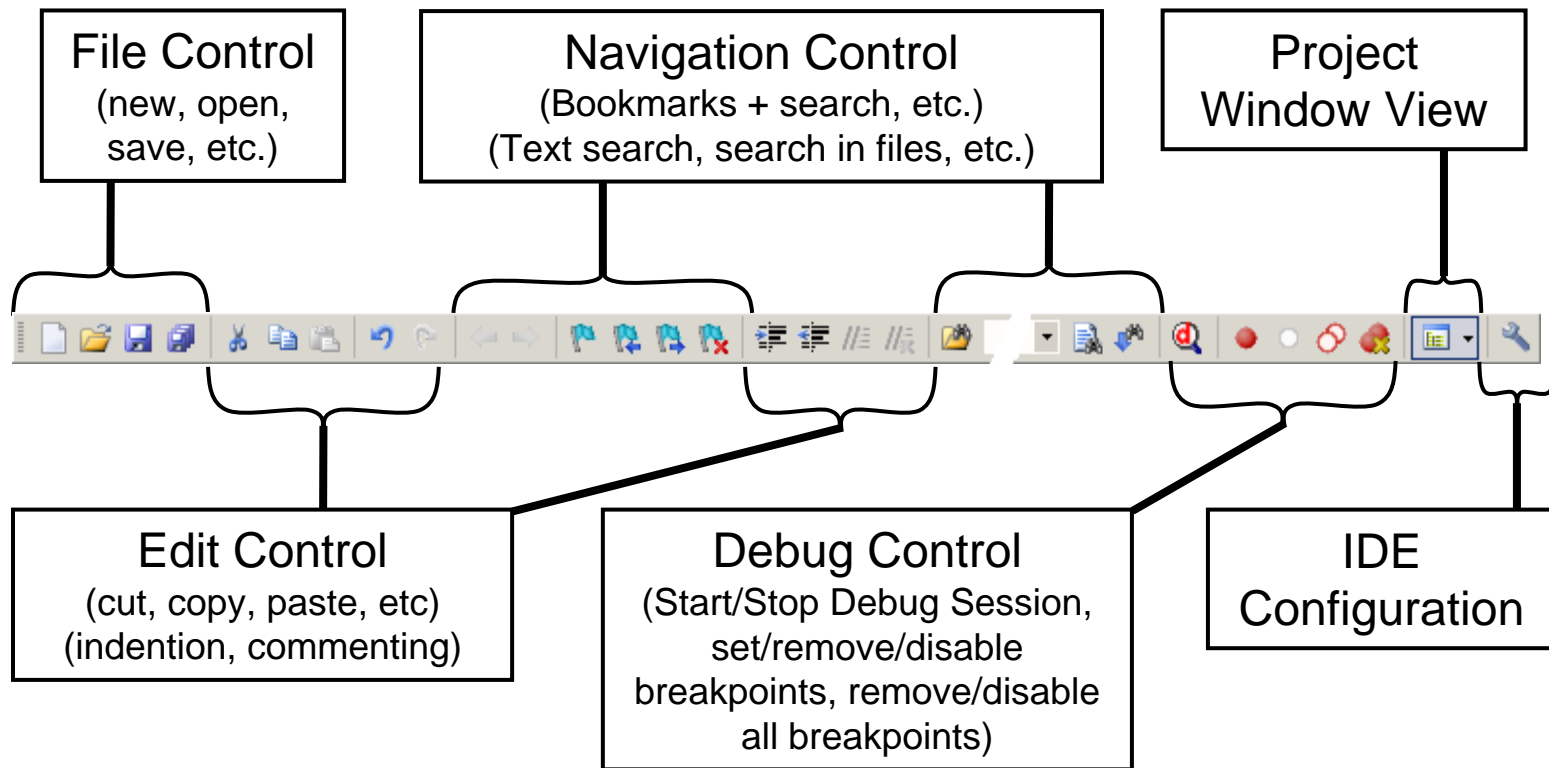



KEIL μ Vision - Menu Bars (2)

■ Menu Bar 2

- Can be moved in bar window area or set floating

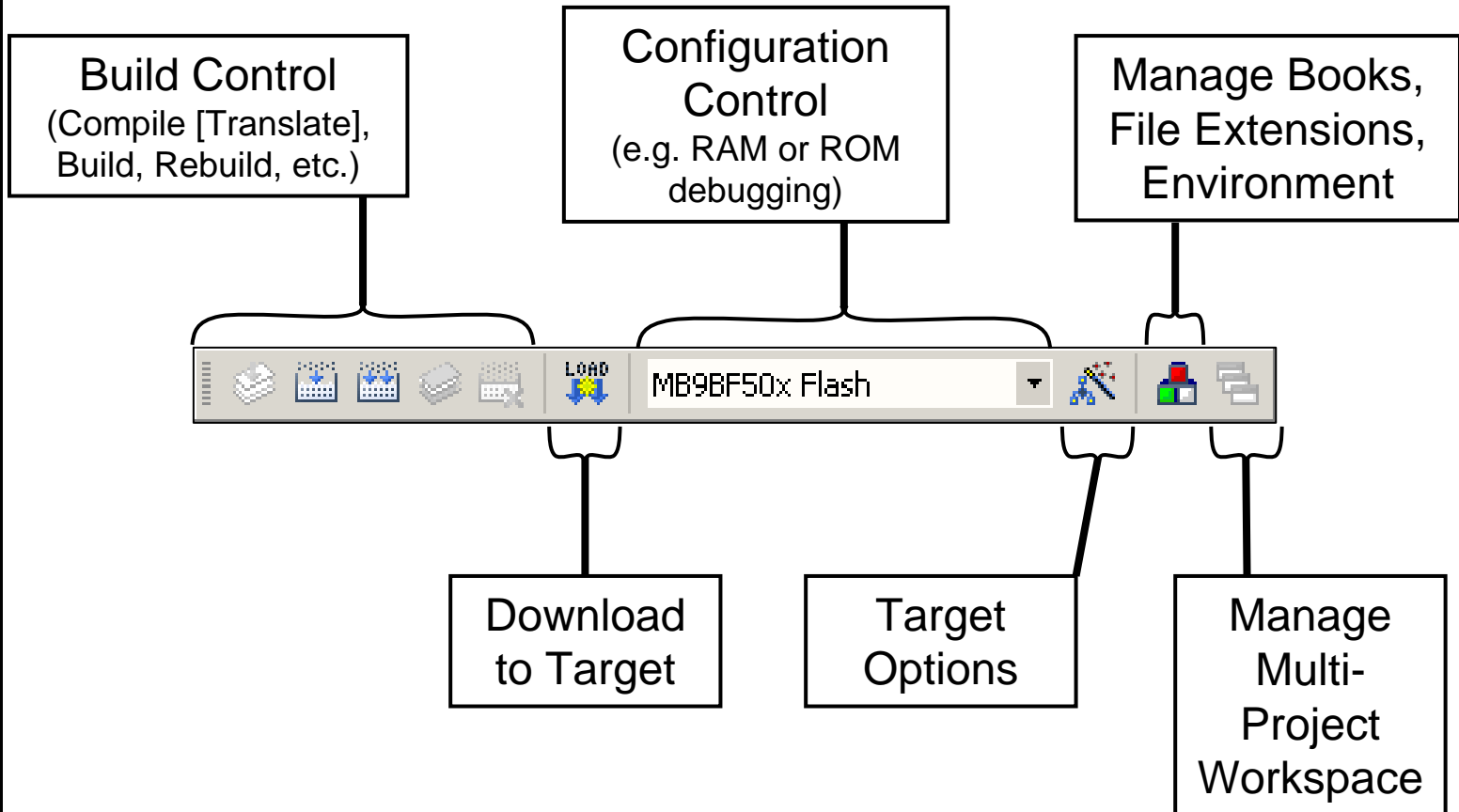

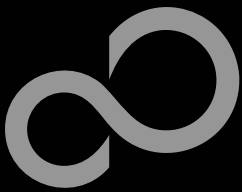

KEIL μ Vision – Project Window

■ μ Vision Project Window

Project Name

Startup Code Subfolder

Startup Code Source and Header Files

Main Project Code Subfolder

Main Project Code Source and Header Files

Project Description Subfolder and Abstract File

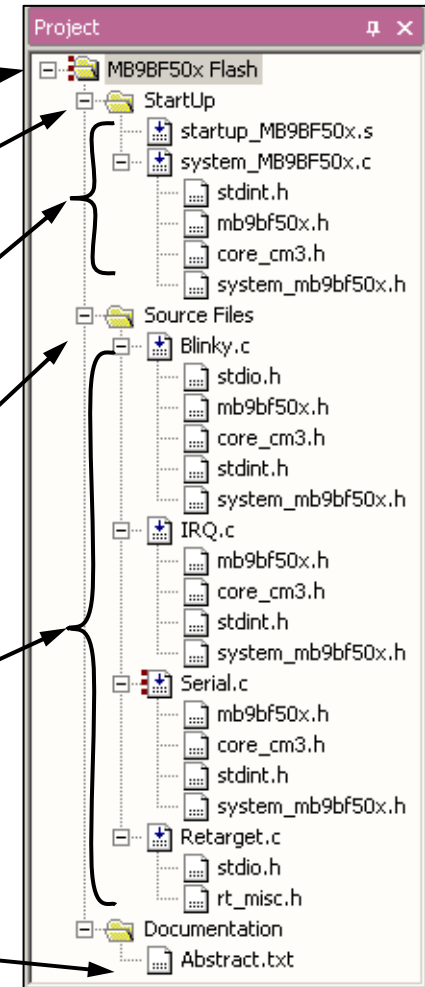



KEIL μ Vision – Making Project

■ Making the Project

- Use Rebuild Icon () or *Project*→*Rebuild all target files*
- Check for no errors in Output window below
- Build errors are shown in Output window.
 - Can be double-clicked by showing the source line with a blue arrow

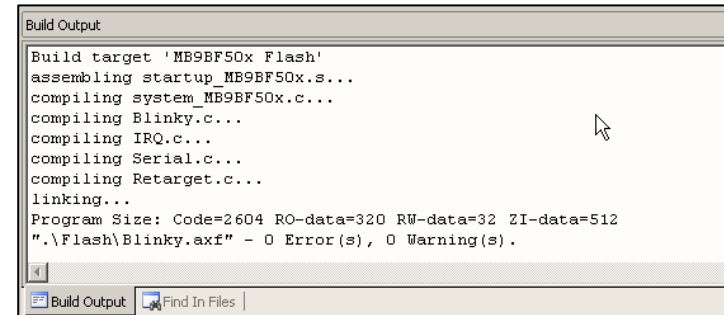

```
Build Output
Build target 'MB9BF50x Flash'
assembling startup_MB9BF50x.s...
compiling system_MB9BF50x.c...
compiling Blinky.c...
compiling IRQ.c...
compiling Serial.c...
compiling Retarget.c...
linking...
Program Size: Code=2604 RO-data=320 RW-data=32 ZI-data=512
".\Flash\Blinky.axf" - 0 Error(s), 0 Warning(s).
```

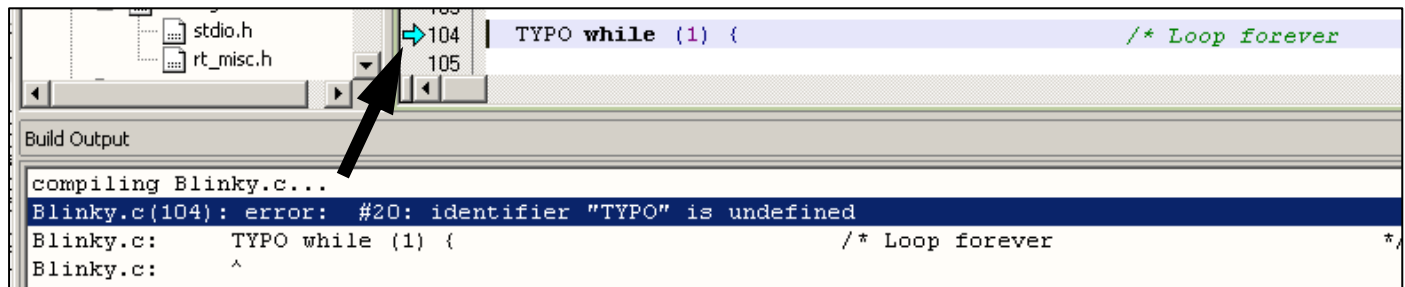



```
stdio.h
rt_misc.h
104 TYPO while (1) { /* Loop forever
105
Build Output
compiling Blinky.c...
Blinky.c(104): error: #20: identifier "TYPO" is undefined
Blinky.c: TYPO while (1) { /* Loop forever
Blinky.c: ^
```



KEIL μ Vision – Debug (1)

■ Start Debugging

- Download to target first, when MCU Flash does not contain the current application opened and built in the IDE
 - Use Download Icon () or Menu: *Flash*→*Download*
- Start Debug Session
 - Use Start/Stop Debug Icon () or Menu: *Debug*→*Start/Stop Debug Session*
- Ending Debug Session
 - Use same way as for starting debug session

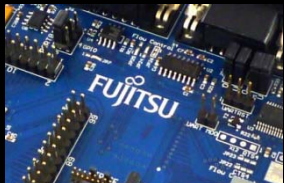
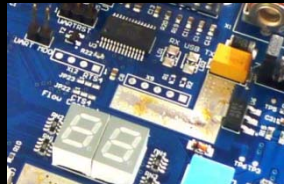

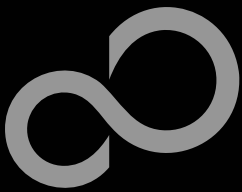

KEIL μ Vision - Debug (2)

■ Debugging Icon Bar

- During a Debug Session there will be visible a new icon bar

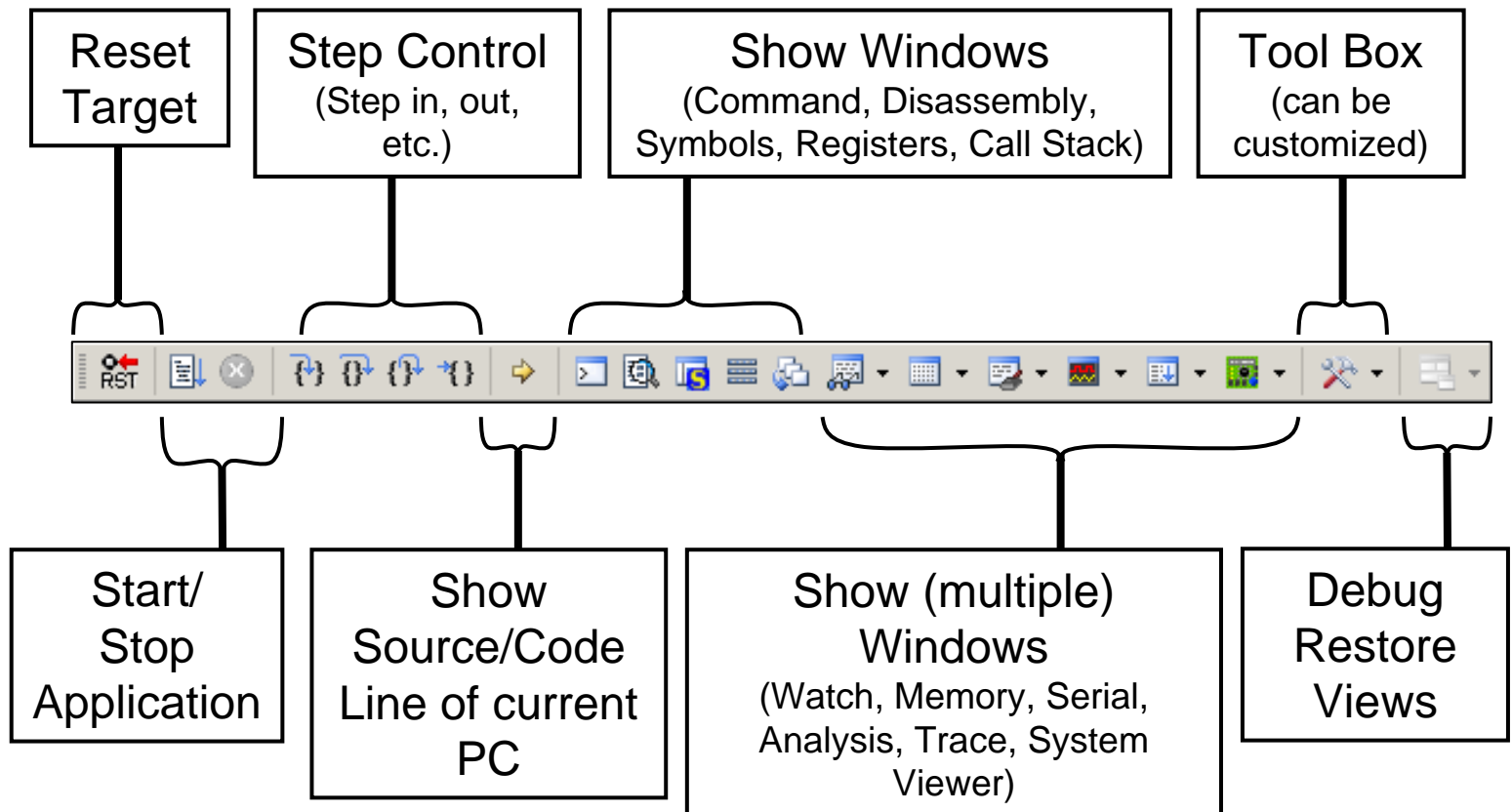



KEIL μ Vision - Debug (3)

■ Source View

- The Source windows do not change contents but get additional information

Active Breakpoint

Disabled Breakpoint

Current Program Counter

Current Cursor Line of Source Code

Code Lines with compiled Instructions (dark grey )

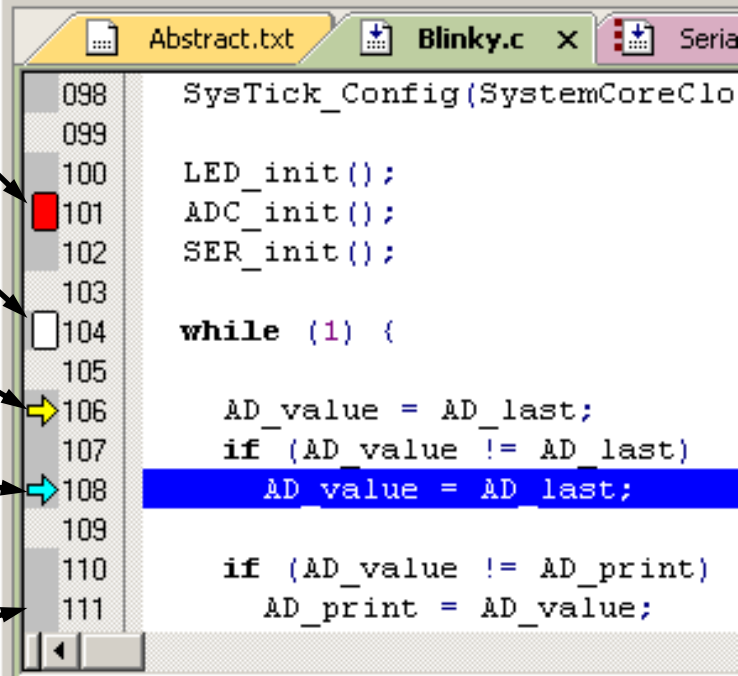

```
Abstract.txt  Blinky.c  Serial
098  SysTick_Config(SystemCoreClo
099
100  LED_init();
101  ADC_init();
102  SER_init();
103
104  while (1) {
105
106      AD_value = AD_last;
107      if (AD_value != AD_last)
108          AD_value = AD_last;
109
110      if (AD_value != AD_print)
111          AD_print = AD_value;
```



KEIL μ Vision - Debug (4)

■ Disassembly View

- Mixed mode is selectable and deselectable

Active Breakpoint

Disabled Breakpoint

Current Program Counter

Current Cursor Line of Code highlighted in yellow background (■)

```
Disassembly
0x0000042A F7FFFA3 BL.W LED_i
101: ADC_init();
0x0000042E F7FFF67 BL.W ADC_i
102: SER_init();
103:
0x00000432 F00F8AE BL.W SER_i
104: while (1) {
105:
0x00000436 E015 B 0x0000
106: AD_value = AD_last;
0x00000438 4816 LDR r0, [p
0x0000043A 8804 LDRH r4, [r
107: if (AD_value != AD_last
```

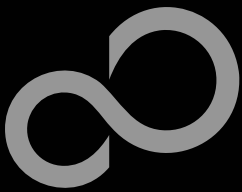

KEIL μ Vision - Debug (5)

■ Memory Window

- Up to 4 Memory windows can be displayed in tabs
- Memory is updated during runtime
- Memory window tabs are shared with Watch windows

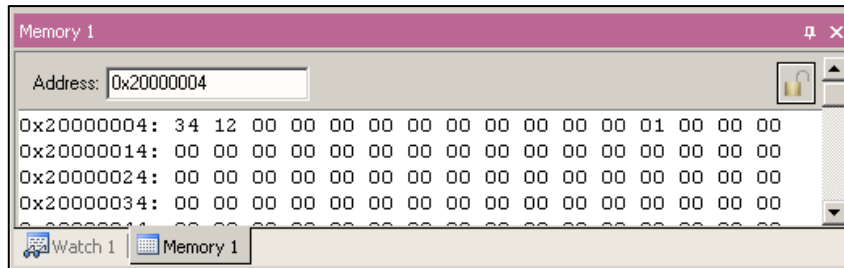

■ Register View

- Register view is a tab of the Project window
- Changes are highlighted in dark blue text background
- Register tree knots can be expanded

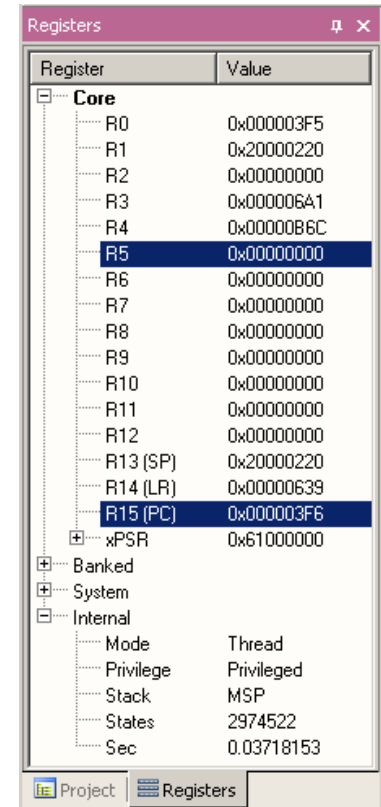



KEIL μ Vision – Debug (6)

■ Variable Windows

● Watch Windows

- Up to 2 Watch windows are sharing their tabs with e.g. Memory and Local views
- Updated during runtime
- Any changes are highlighted in dark blue text background color
- Displayed values can be changed by user during break

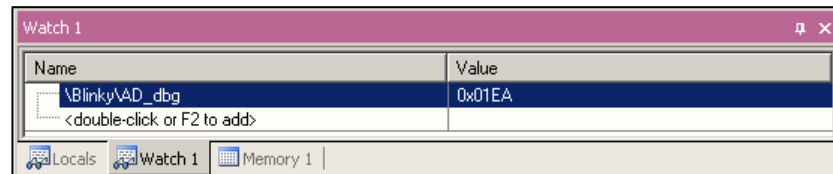

● Local View

- The local view shares the tab with e.g. Memory and Watch windows
- Any changes are highlighted in dark blue text background color
- Displayed values can be changed by user during break

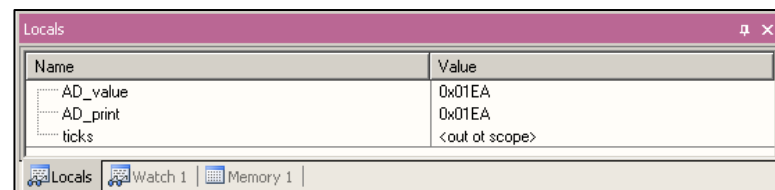

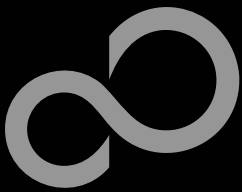

KEIL μ Vision - Trace (ULINK ME)

■ Trace via ITM

- Simple Trace views via Instrumentation Trace Macro is supported by μ LINK ME
 - Records
 - Exceptions
 - Counters



Type	Dvf	Num	Address	Data	PC	Dly	Cycles	Time[s]
ITM		0	41H				82975148	1.03718935
ITM		0	44H				82975293	1.03719116
ITM		0	20H			X	82988592	1.03735740
ITM		0	76H			X	82988592	1.03735740
ITM		0	61H			X	82988592	1.03735740
ITM		0	6CH			X	82988592	1.03735740
ITM		0	75H			X	82988592	1.03735740
ITM		0	65H			X	82988592	1.03735740
ITM		0	20H			X	82988592	1.03735740
ITM		0	3DH			X	82988592	1.03735740
ITM		0	20H			X	82988592	1.03735740
ITM		0	30H			X	82988592	1.03735740
ITM		0	78H			X	82988592	1.03735740
ITM		0	30H				82993831	1.03742289
ITM		0	31H			X	83001392	1.03751740
ITM		0	45H			X	83001392	1.03751740
ITM		0	42H			X	83001392	1.03751740
ITM		0	0DH			X	83001392	1.03751740
ITM		0	0AH			X	83001392	1.03751740
ITM		0	0DH			X	83001392	1.03751740



KEIL μ Vision - Trace (ULINK Pro) (1)

■ Trace via ETM

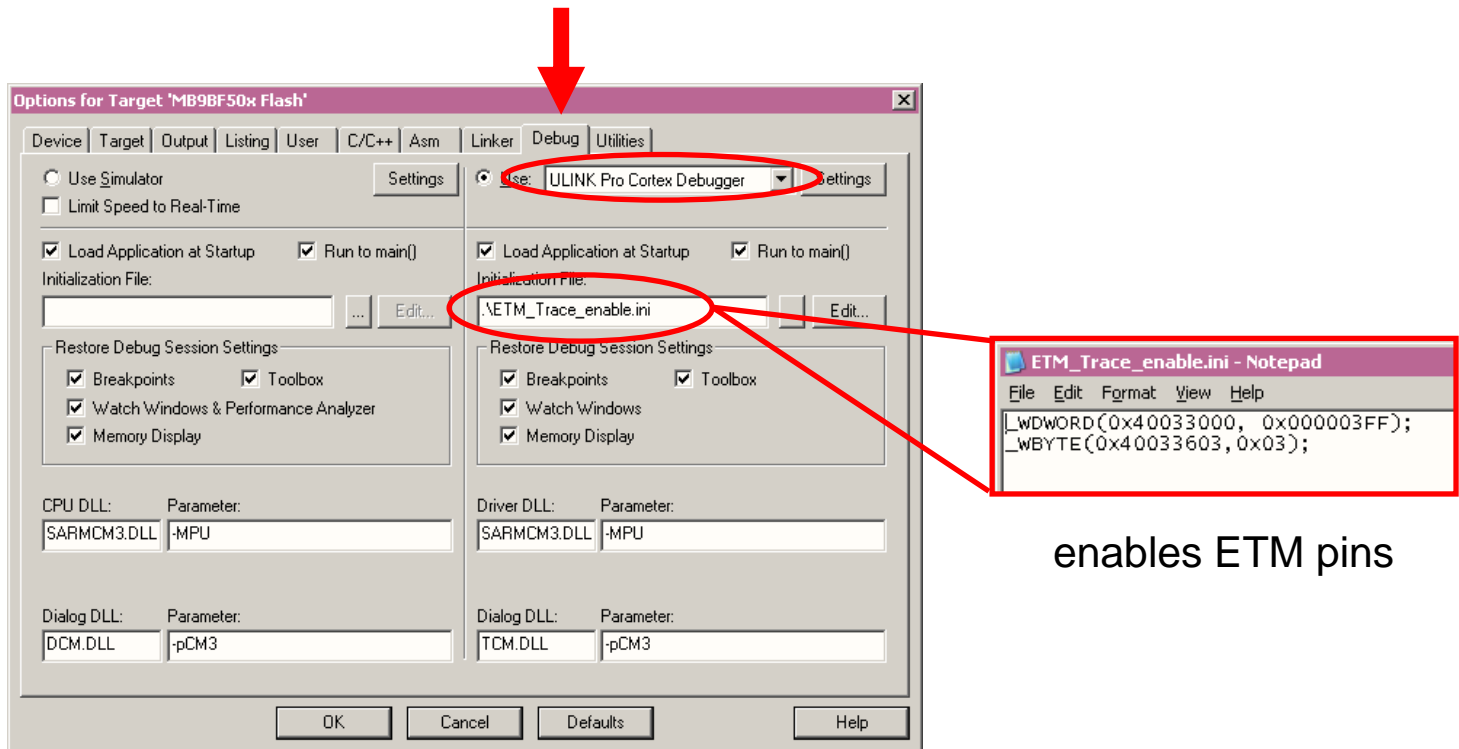
- Check settings in menu:
Flash → *Configure Flash Tools...* Tab: *Debug*



Options for Target 'MB9BF50x Flash'

Device | Target | Output | Listing | User | C/C++ | Asm | Linker | **Debug** | Utilities

Use Simulator Limit Speed to Real-Time

Use: **ULINK Pro Cortex Debugger** Settings

Load Application at Startup Run to main()

Initialization File: Edit...

Restore Debug Session Settings

Breakpoints Toolbox

Watch Windows & Performance Analyzer

Memory Display

CPU DLL: Parameter: SARMCM3.DLL -MPU

Driver DLL: Parameter: SARMCM3.DLL -MPU

Dialog DLL: Parameter: DCM.DLL -pCM3

Dialog DLL: Parameter: TCM.DLL -pCM3

OK Cancel Defaults Help

ETM_Trace_enable.ini - Notepad

```
File Edit Format View Help
_LWDWORD(0x40033000, 0x000003FF);
_WBYTE(0x40033603, 0x03);
```

enables ETM pins



KEIL μ Vision - Trace (ULINK Pro) (2)

■ Instruction Trace

- Real Time Trace recording
- Output can be filtered by several ETM and ITM events
- Trace buffer is held in PC memory and transferred to μ Vision on break

#	Type	Flag	Num	PC	Opcode	Instruction	Source Code
1048564	ETM			0x0000043E	4284	CMP r4,r0	
1048565	ETM			0x00000440	D001	BEQ 0x00000446	
1048566	ETM			0x00000446	42AC	CMP r4,r5	111: if (AD_value != AD_print) { /* Make sure that AD inter
1048567	ETM			0x00000448	D002	BEQ 0x00000450	
1048568	ETM			0x00000450	4814	LDR r0,[pc,#80] ;@0x00000444	116: if (clock_1s) {
1048569	ETM			0x00000452	7800	LDRB r0,[r0,#0x00]	

```
108     if (AD_value != AD_last)           /* Make sure that AD interrupt did */
109         AD_value = AD_last;           /* not interfere with value reading */
110
111     if (AD_value != AD_print) {       /* Make sure that AD interrupt did */
112         AD_print = AD_value;         /* Get unscaled value for printout */
113         AD_dbg   = AD_value;
```

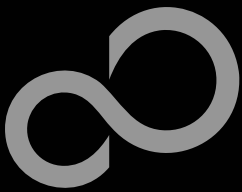
KEIL μ Vision – Simulator

■ Simulator

- The Core Simulator can be selected by the menu: *Flash*→*Configure Flash Tools...* and then choosing *Use Simulator*
- Look & feel is like using ULINK debugger
- Controlable also with *.ini files



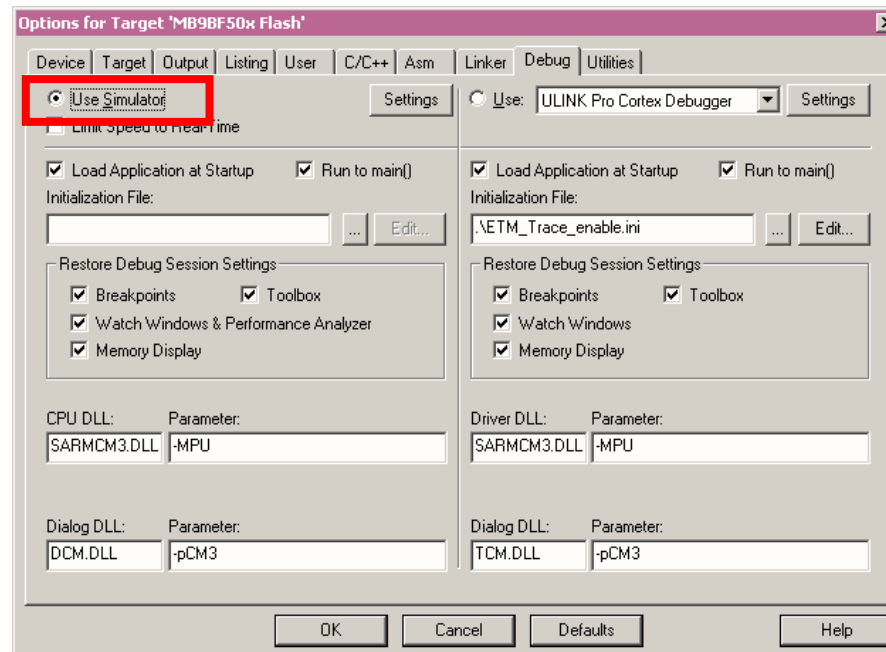

Further Steps

■ In order to learn more about Fujitsu's microcontrollers

- Visit our microcontroller website
 - <http://mcu.emea.fujitsu.com>
 - http://mcu.emea.fujitsu.com/mcu_product/detail/MB9BF506NPMC.htm
- See our application notes
 - http://mcu.emea.fujitsu.com/mcu_product/mcu_all_appnotes.htm
- See our software examples
 - http://mcu.emea.fujitsu.com/mcu_product/mcu_all_software.htm

■ Contact your local distributor ...

- for individual support
- to register for our monthly FM3 seminar
- to order the latest 'Fujitsu Micros DVD' containing all information regarding Fujitsu's 8-bit, 16-bit, and 32-bit microcontrollers

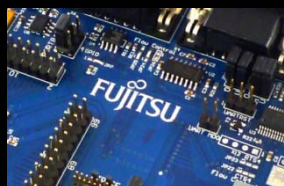



Contacts - Distribution

■ European distributors

■ Anatec

www.anatec.ch

■ EBV Elektronik

www.ebv.com

■ Farnell

www.farnell.com

■ Glyn

www.glyn.de , www.glyn.ch

■ Ineltek

www.ineltek.com

■ Melchioni Electronica

www.melchioni.it

■ PN Electronics

www.pne.fr

■ Rutronik Elektronische
Bauelemente

www.rutronik.com





Fujitsu Semiconductor Europe

■ Germany (Headquarters)

- Pittlerstrasse 47, D-63225 Langen
- Tel: (0 61 03) 69 00, Fax: (0 61 03) 69 01 22

■ France

- 2-12 Chemin des Femmes, F-91300 Massy
- Tel: (01) 64 47 97 07, Fax: (01) 64 47 97 01

■ Italy

- Palazzo Pitagora – Milano 3 City, Via Ludovico il Moro 4B, I-20080 Basiglio, Milano
- Tel: (02) 90 45 02 1, Fax: (02) 90 75 00 87

■ United Kingdom

- Network House, Norreys Drive, Maidenhead, Berkshire SL6 4FJ
- Tel: (01628) 50 46 00, Fax: (01628) 50 46 66

■ World Wide Web

- <http://emea.fujitsu.com/microelectronics>
- <http://mcu.emea.fujitsu.com>
- Contact: mcu_ticket.FSEU@de.fujitsu.com





EU-Konformitätserklärung / EU declaration of conformity

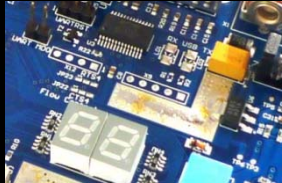

Hiermit erklären wir, Fujitsu Semiconductor Europe GmbH, Pittlerstrasse 47, 63225 Langen, Germany dass dieses Board aufgrund seiner Konzipierung und Bauart sowie in den von uns in Verkehr gebrachten Ausführung(en) den grundlegenden Anforderungen der EU-Richtlinie 2004/108/EC „Elektromagnetische Verträglichkeit“ entspricht. Durch eine Veränderung des Boards (Hard- und/ oder Software) verliert diese Erklärung ihre Gültigkeit!

We, Fujitsu Semiconductor Europe GmbH, Pittlerstrasse 47, 63225 Langen, Germany hereby declare that the design, construction and description circulated by us of this board complies with the appropriate basic safety and health requirements according to the EU Guideline 2004/108/EC entitled 'Electro-Magnetic Compatibility'. Any changes to the equipment (hardware and/ or software) will render this declaration invalid!

Note:

All data and power supply lines connected to this starter kit should be kept as short as possible, with a maximum allowable length of 3m. Shielded cables should be used for data lines. As a rule of thumb, the cable length used when connecting external circuitry to the MCU pin header connectors for example should be less than 20cm. Longer cables may affect EMC performance and cause radio interference.

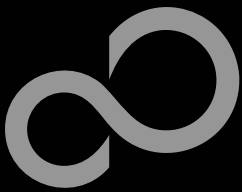

Recycling

■ Gültig für EU-Länder:

- Gemäß der Europäischen WEEE-Richtlinie und deren Umsetzung in landesspezifische Gesetze nehmen wir dieses Gerät wieder zurück.
- Zur Entsorgung schicken Sie das Gerät bitte an die folgende Adresse:

■ Valid for European Union Countries:

- According to the European WEEE-Directive and its implementation into national laws we take this device back.
- For disposal please send the device to the following address:

Fujitsu Semiconductor Europe GmbH

Warehouse/Disposal

Monzastraße 4a

D-63225 Langen



■ This board is compliant with China RoHS





CD Contents

■ Software

- [FUJITSU FLASH MCU Programmer](#)
- [FLASH USB DIRECT Programmer](#)
- [SKwizard](#)

■ Documents

- [Schematic 'SK-FM3-100PMC'](#)
- [Data sheet MB9B500 Series](#)
- [Peripheral Manual](#)
[Errata sheet](#)
- [Technical Reference Manual](#)
- [Flash Programming Manual](#)

■ Examples

- [mb9bf506n template](#)
- Further examples on CD [Examples](#) and on our website

Note:

Please copy the examples to your local drive!

Download the latest version from the following website:

<http://mcu.emea.fujitsu.com>



Компания «ЭлектроПласт» предлагает заключение долгосрочных отношений при поставках импортных электронных компонентов на взаимовыгодных условиях!

Наши преимущества:

- Оперативные поставки широкого спектра электронных компонентов отечественного и импортного производства напрямую от производителей и с крупнейших мировых складов;
- Поставка более 17-ти миллионов наименований электронных компонентов;
- Поставка сложных, дефицитных, либо снятых с производства позиций;
- Оперативные сроки поставки под заказ (от 5 рабочих дней);
- Экспресс доставка в любую точку России;
- Техническая поддержка проекта, помощь в подборе аналогов, поставка прототипов;
- Система менеджмента качества сертифицирована по Международному стандарту ISO 9001;
- Лицензия ФСБ на осуществление работ с использованием сведений, составляющих государственную тайну;
- Поставка специализированных компонентов (Xilinx, Altera, Analog Devices, Intersil, Interpoint, Microsemi, Aeroflex, Peregrine, Syfer, Eurofarad, Texas Instrument, Miteq, Cobham, E2V, MA-COM, Hittite, Mini-Circuits, General Dynamics и др.);

Помимо этого, одним из направлений компании «ЭлектроПласт» является направление «Источники питания». Мы предлагаем Вам помощь Конструкторского отдела:

- Подбор оптимального решения, техническое обоснование при выборе компонента;
- Подбор аналогов;
- Консультации по применению компонента;
- Поставка образцов и прототипов;
- Техническая поддержка проекта;
- Защита от снятия компонента с производства.



Как с нами связаться

Телефон: 8 (812) 309 58 32 (многоканальный)

Факс: 8 (812) 320-02-42

Электронная почта: org@eplast1.ru

Адрес: 198099, г. Санкт-Петербург, ул. Калинина, дом 2, корпус 4, литера А.