

4 PIN DIP PHOTOTRANSISTOR PHOTOCOUPLER

EL816 Series

Features:

- Current transfer ratio
(CTR: 50~600% at $I_F = 5\text{mA}$, $V_{CE} = 5\text{V}$)
(CTR: 63~320% at $I_F = 10\text{mA}$, $V_{CE} = 5\text{V}$)
- High isolation voltage between inputs and output ($V_{iso} = 5000\text{ V rms}$)
- Creepage distance $> 7.62\text{ mm}$
- Operating temperature up to $+110^\circ\text{C}$
- Compact small outline package
- Pb free and RoHS compliant.
- UL approved (No. E214129)
- VDE approved (No. 132249)
- SEMKO approved
- NEMKO approved
- DEMKO approved
- FIMKO approved
- CSA approved (No. 1143607)

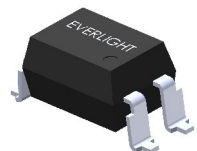
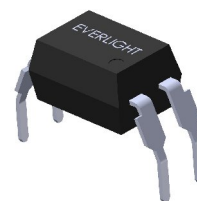
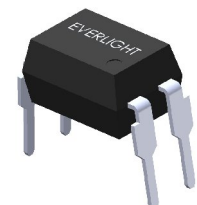

Description

The EL816 series of devices each consist of an infrared emitting diodes, optically coupled to a phototransistor detector.

They are packaged in a 4-pin DIP package and available in wide-lead spacing and SMD option.

Applications

- Programmable controllers
- System appliances, measuring instruments
- Telecommunication equipments
- Home appliances, such as fan heaters, etc.
- Signal transmission between circuits of different potentials and impedances

Schematic

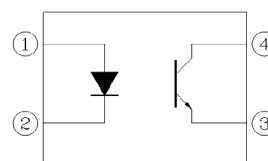

Pin Configuration

1. Anode
2. Cathode
3. Emitter
4. Collector



LIGHTING FOREVER

4 PIN DIP PHOTOTRANSISTOR PHOTOCOUPLER

EL816 Series

Absolute Maximum Ratings ($T_a=25^{\circ}\text{C}$)

Parameter		Symbol	Rating	Unit
Input	Forward current	I_F	60	mA
	Peak forward current (1us, pulse)	I_{FP}	1	A
	Reverse voltage	V_R	6	V
	Power dissipation No derating required up to $T_a = 100^{\circ}\text{C}$	P_D	100	mW
Output	Power dissipation Derating factor (above $T_a = 80^{\circ}\text{C}$)	P_C	150	mW
			5.8	mW/ $^{\circ}\text{C}$
	Collector current	I_C	50	mA
	Collector-Emitter voltage	V_{CEO}	80	V
	Emitter-Collector voltage	V_{ECO}	6	V
Total power dissipation		P_{TOT}	200	mW
Isolation voltage ^{*1}		V_{ISO}	5000	V rms
Operating temperature		T_{OPR}	-55 ~ +110	$^{\circ}\text{C}$
Storage temperature		T_{STG}	-55 ~ +125	$^{\circ}\text{C}$
Soldering temperature ^{*2}		T_{SOL}	260	$^{\circ}\text{C}$

Notes

*1 AC for 1 minute, R.H. = 40 ~ 60% R.H. In this test, pins 1 & 2 are shorted together, and pins 3 & 4 are shorted together.

*2 For 10 seconds.



LIGHTING FOREVER

4 PIN DIP PHOTOTRANSISTOR PHOTOCOUPLER

EL816 Series

Electrical Characteristics (T_a=25°C unless specified otherwise)

Input

Parameter	Symbol	Min.	Typ.*	Max.	Unit	Condition
Forward voltage	V _F	-	1.2	1.4	V	I _F = 20mA
Reverse current	I _R	-	-	10	μA	V _R = 4V
Input capacitance	C _{in}	-	30	250	pF	V = 0, f = 1kHz

Output

Parameter	Symbol	Min.	Typ.*	Max.	Unit	Condition
Collector-Emitter dark current	I _{CEO}	-	-	100	nA	V _{CE} = 20V, I _F = 0mA
Collector-Emitter breakdown voltage	BV _{CEO}	80	-	-	V	I _C = 0.1mA
Emitter-Collector breakdown voltage	BV _{ECO}	6	-	-	V	I _E = 0.1mA

Transfer Characteristics (T_a=25°C unless specified otherwise)

Parameter		Symbol	Min.	Typ.*	Max.	Unit	Condition
Current Transfer ratio	EL816	CTR	50	-	600	%	I _F = 5mA, V _{CE} = 5V
	EL816A		80	-	160		
	EL816B		130	-	260		
	EL816C		200	-	400		
	EL816D		300	-	600		
	EL816X		100	-	200		
	EL816Y		150	-	300		
	EL816I	CTR	63	-	125	%	I _F = 10mA, V _{CE} = 5V
	EL816J		100	-	200		
	EL816K		160	-	320		
	EL816I		22	-	-		I _F = 1mA, V _{CE} = 5V
	EL816J		34	-	-		
	EL816K		56	-	-		



LIGHTING FOREVER

4 PIN DIP PHOTOTRANSISTOR PHOTOCOUPLER

EL816 Series

Transfer Characteristics ($T_a=25^\circ\text{C}$ unless specified otherwise) Continuity

Collector-Emitter saturation voltage	$V_{CE(sat)}$	-	0.1	0.2	V	$I_F = 20\text{mA}, I_C = 1\text{mA}$
Isolation resistance	R_{IO}	5×10^{10}	-	-	Ω	$V_{IO} = 500\text{Vdc}$, 40~60% R.H.
Floating capacitance	C_{IO}	-	0.6	1.0	pF	$V_{IO} = 0, f = 1\text{MHz}$
Cut-off frequency	f_c	-	80	-	kHz	$V_{CE} = 5\text{V}, I_C = 2\text{mA}$ $R_L = 100\Omega, -3\text{dB}$
Rise time	t_r	-	4	18	μs	$V_{CE} = 2\text{V}, I_C = 2\text{mA}$, $R_L = 100\Omega$
Fall time	t_f	-	3	18	μs	

* Typical values at $T_a = 25^\circ\text{C}$

EVERLIGHT

4 PIN DIP PHOTOTRANSISTOR PHOTOCOUPLER

EL816 Series

Typical Performance Curves

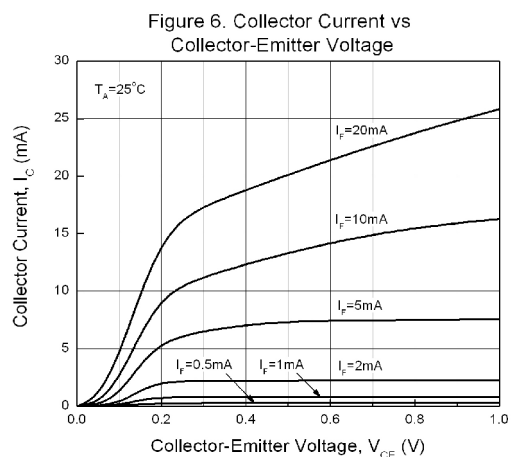
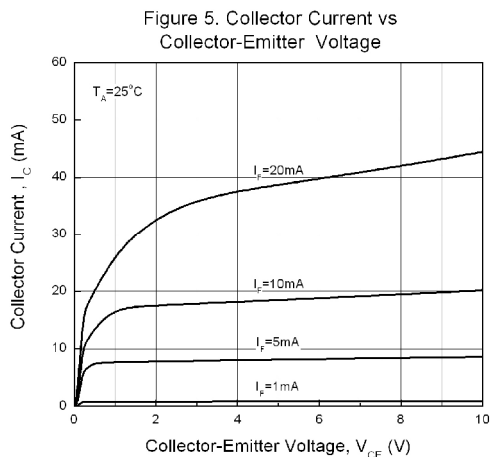
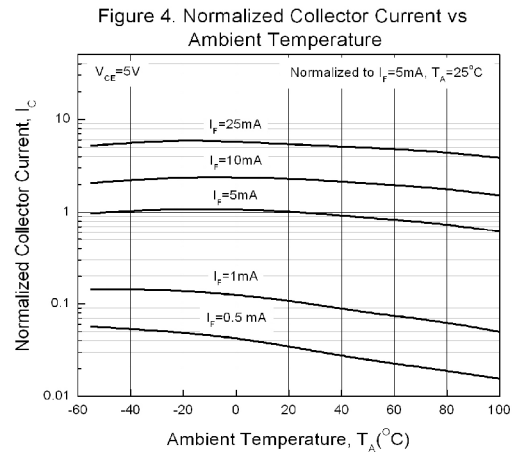
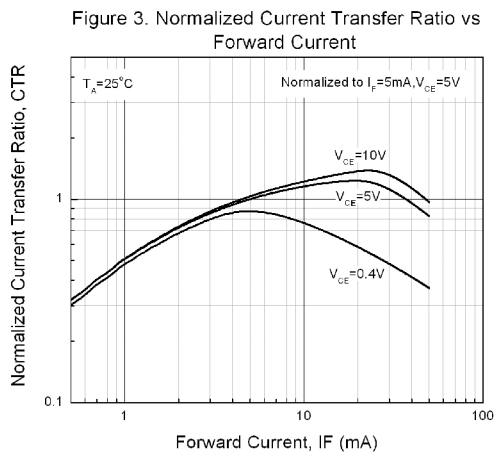
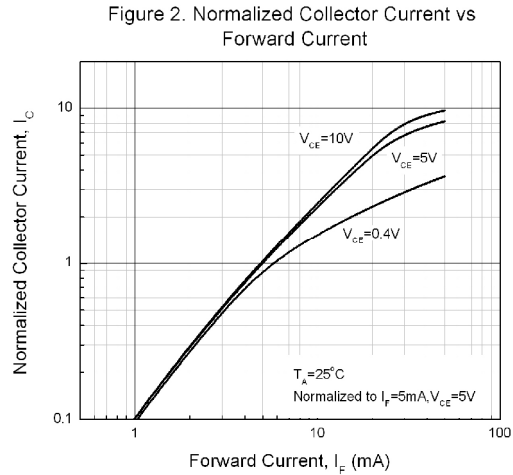
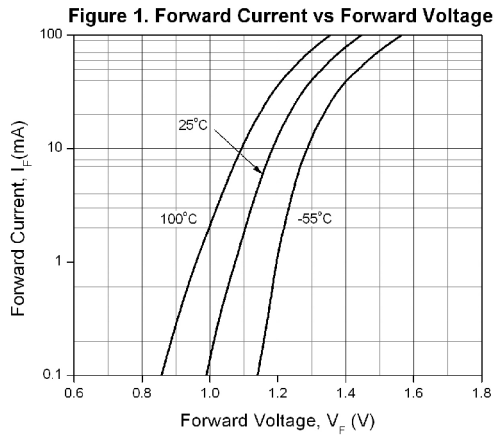

4 PIN DIP PHOTOTRANSISTOR PHOTOCOUPLER

EL816 Series

Figure 7. Collector Dark Current vs Ambient Temperature

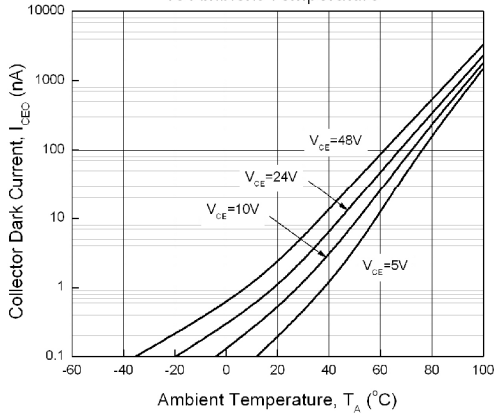

Figure 8. Switching Time vs Load Resistance

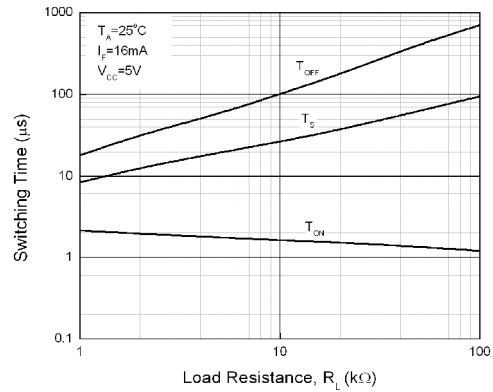

Figure 9. Collector-Emitter Saturation Voltage vs Ambient Temperature

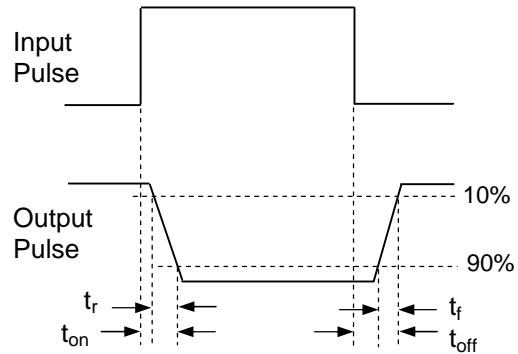
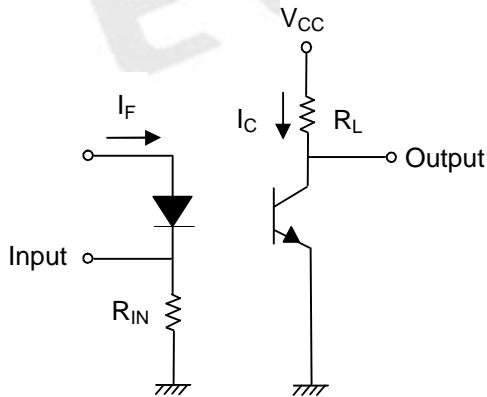
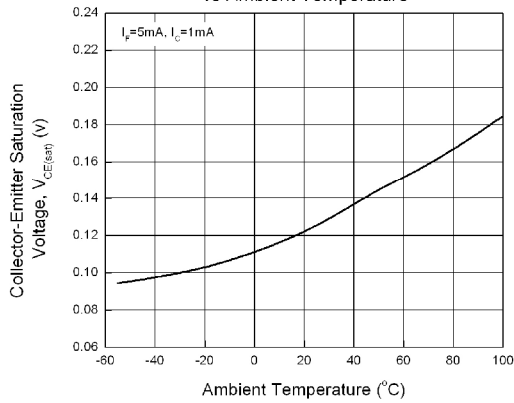

Figure 10. Switching Time Test Circuit & Waveforms



LIGHTING FOREVER

4 PIN DIP PHOTOTRANSISTOR PHOTOCOUPLER

EL816 Series

Order Information

Part Number

EL816(X)(Y)(Z)-FV

Note

- X = Lead form option (S, S1, S2, M or none)
- Y = CTR Rank (A, B, C, D, X, Y, I, J, H or none)
- Z = Tape and reel option (TA, TB, TU, TD or none)
- F = Lead frame option (F: Iron, None: copper)
- V = VDE (optional)

Option	Description	Packing quantity
None	Standard DIP-4	100 units per tube
M	Wide lead bend (0.4 inch spacing)	100 units per tube
S (TA)	Surface mount lead form + TA tape & reel option	1000 units per reel
S (TB)	Surface mount lead form + TB tape & reel option	1000 units per reel
S1 (TA)	Surface mount lead form (low profile) + TA tape & reel option	1000 units per reel
S1 (TB)	Surface mount lead form (low profile) + TB tape & reel option	1000 units per reel
S2 (TA)	Surface mount lead form (Gull-wing) + TA tape & reel option	500 units per reel
S2 (TB)	Surface mount lead form (Gull-wing) + TB tape & reel option	500 units per reel
S (TU)	Surface mount lead form + TU tape & reel option	1500 units per reel
S (TD)	Surface mount lead form + TD tape & reel option	1500 units per reel
S1 (TU)	Surface mount lead form (low profile) + TU tape & reel option	1500 units per reel
S1 (TD)	Surface mount lead form (low profile) + TD tape & reel option	1500 units per reel



LIGHTING FOREVER

4 PIN DIP PHOTOTRANSISTOR PHOTOCOUPLER

EL816 Series

Package Drawing (Dimensions in mm)

Standard DIP Type

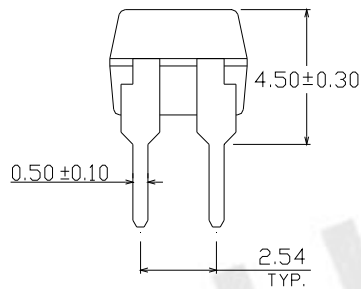
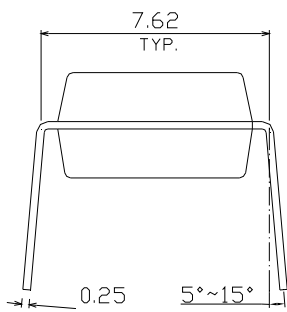
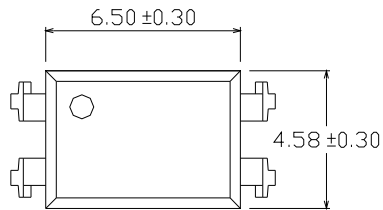

Option M Type

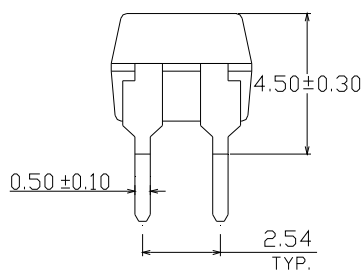
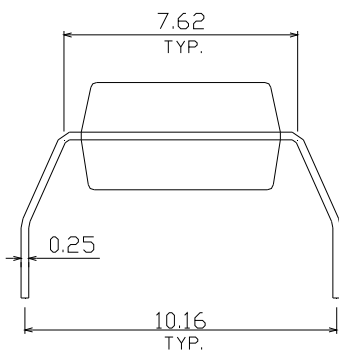
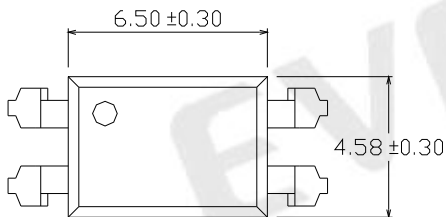



LIGHTING FOREVER

4 PIN DIP PHOTOTRANSISTOR PHOTOCOUPLER

EL816 Series

Option S Type

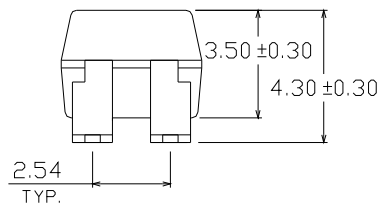
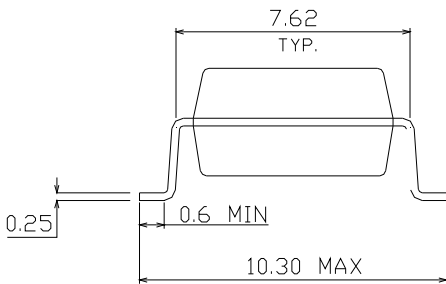
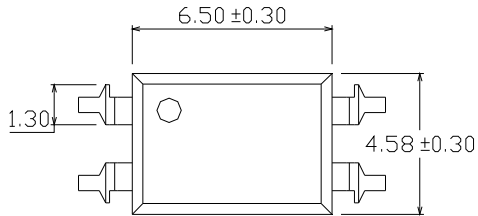

Option S1 Type

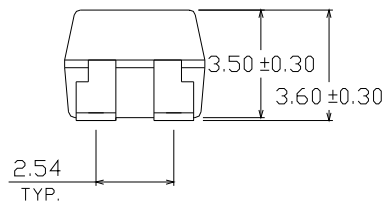
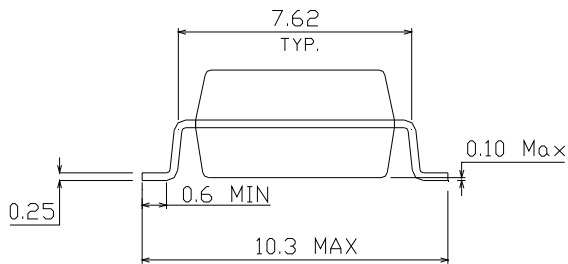
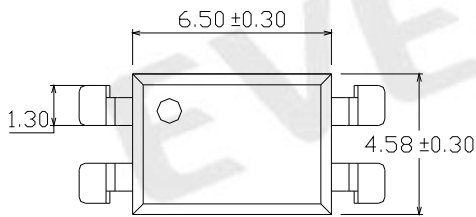



LIGHTING FOREVER

4 PIN DIP PHOTOTRANSISTOR PHOTOCOUPLER

EL816 Series

Option S2 Type

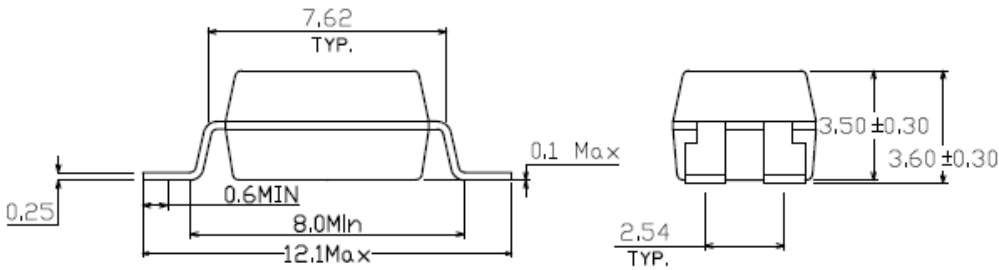
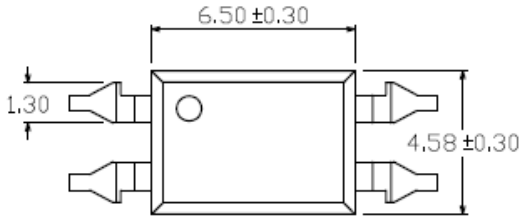

Recommended pad layout for surface mount leadform

For S and S1 option

For S2 option

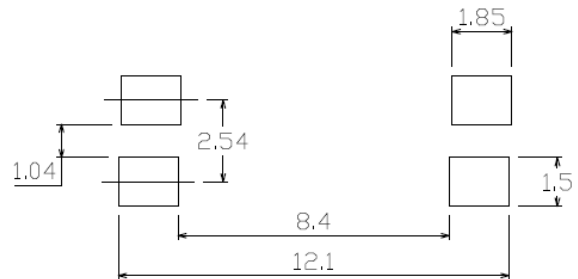
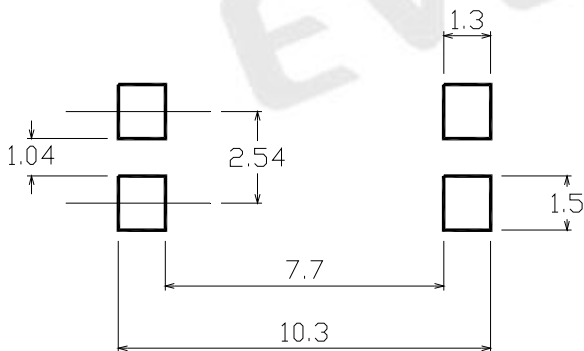



LIGHTING FOREVER

4 PIN DIP PHOTOTRANSISTOR PHOTOCOUPLER

EL816 Series

Device Marking

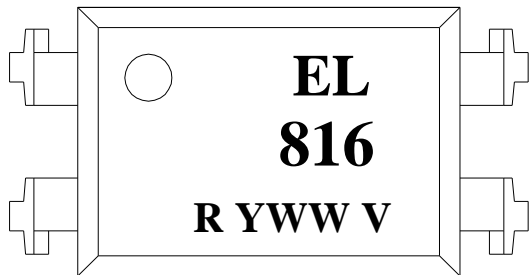

Notes

EL denotes EVERLIGHT
816 denotes Device Number
R denotes CTR Rank
Y denotes 1 digit Year code
WW denotes 2 digit Week code
V denotes VDE (optional)

EVERLIGHT

4 PIN DIP PHOTOTRANSISTOR PHOTOCOUPLER

EL816 Series

Tape & Reel Packing Specifications

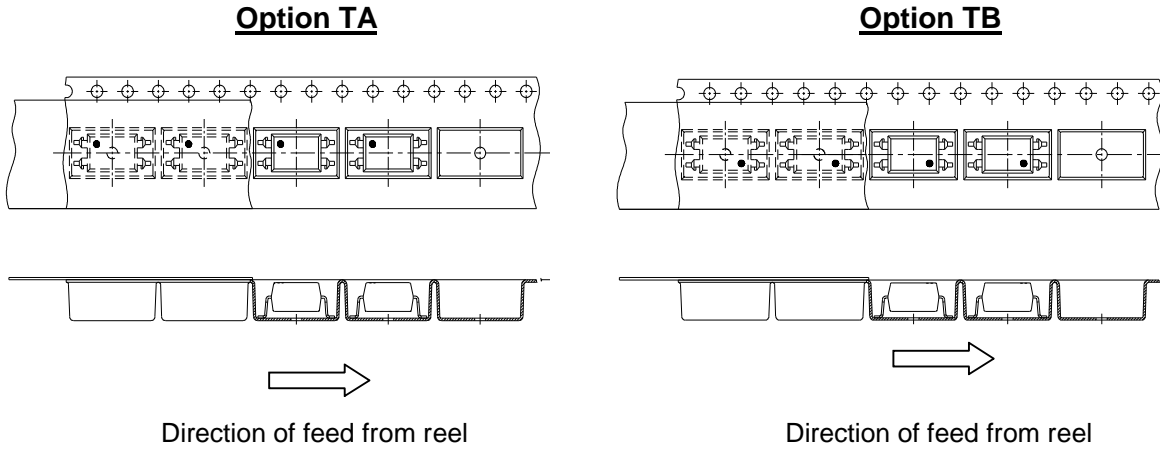

Tape dimensions

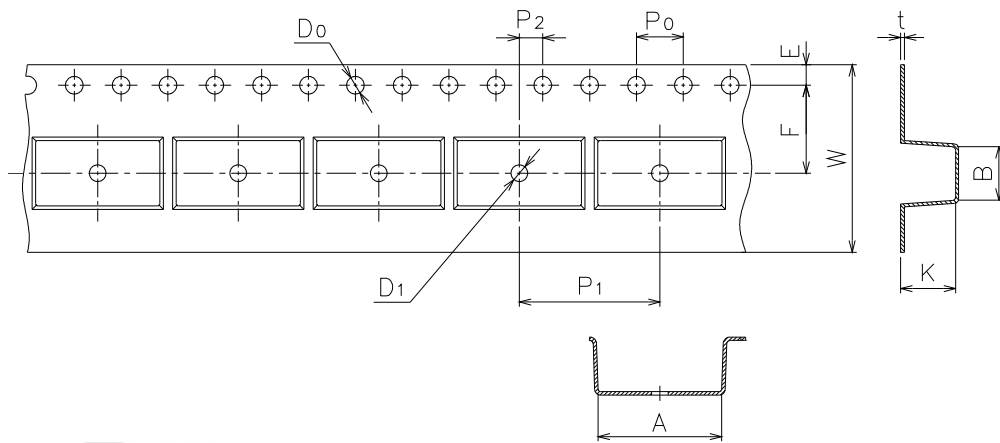

Dimension No.	A	B	Do	D1	E	F
Dimension(mm)	10.4±0.1	4.55±0.1	1.5±0.1	1.5±0.05	1.75±0.1	7.5±0.1
Dimension No.	Po	P1	P2	t	W	K
Dimension(mm)	4.0±0.1	12.0±0.1	2.0±0.1	0.33±0.1	16.0+0.3/ -0.1	4.55±0.1

4 PIN DIP PHOTOTRANSISTOR PHOTOCOUPLER

EL816 Series

Option TD

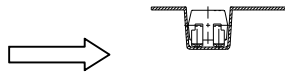
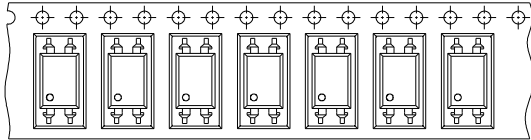

Direction of feed from reel

Option TU

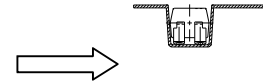
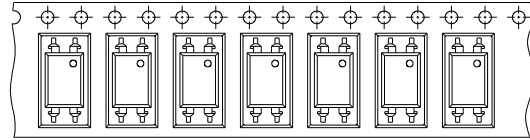

Direction of feed from reel

Tape dimensions

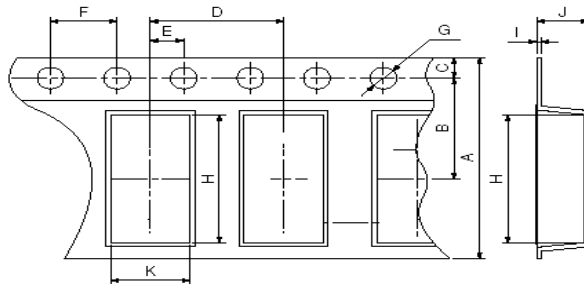

Dimension No.	A	B	C	D	E	F
Dimension(mm)	16.00±0.3	7.5±0.1	1.75±0.1	8.0±0.1	2.0±0.1	4.0±0.1
Dimension No.	G	H	I	J	K	
Dimension(mm)	1.5+0.1/-0	10.4±0.1	0.4±0.05	4.55±0.1	5.1±0.1	



LIGHTING FOREVER

4 PIN DIP PHOTOTRANSISTOR PHOTOCOUPLER

EL816 Series

Solder Reflow Temperature Profile

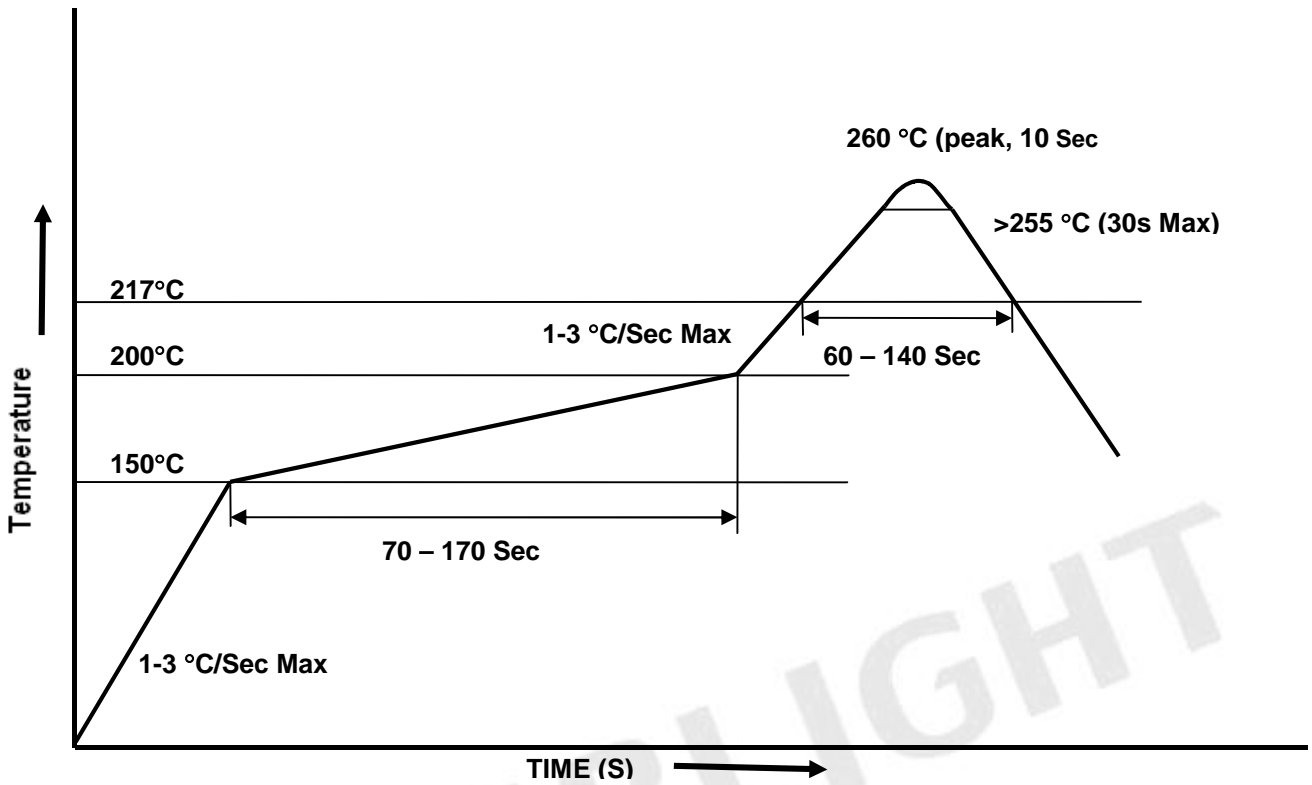



LIGHTING FOREVER

4 PIN DIP PHOTOTRANSISTOR PHOTOCOUPLER

EL816 Series

DISCLAIMER

1. The specifications in this datasheet may be changed without notice. EVERLIGHT reserves the authority on material change for above specification.
2. When using this product, please observe the absolute maximum ratings and the instructions for use as outlined in this datasheet. EVERLIGHT assumes no responsibility for any damage resulting from use of the product which does not comply with the absolute maximum ratings and the instructions included in this datasheet.
3. These specification sheets include materials protected under copyright of EVERLIGHT. Reproduction in any form is prohibited without the specific consent of EVERLIGHT.

EVERLIGHT



Компания «ЭлектроПласт» предлагает заключение долгосрочных отношений при поставках импортных электронных компонентов на взаимовыгодных условиях!

Наши преимущества:

- Оперативные поставки широкого спектра электронных компонентов отечественного и импортного производства напрямую от производителей и с крупнейших мировых складов;
- Поставка более 17-ти миллионов наименований электронных компонентов;
- Поставка сложных, дефицитных, либо снятых с производства позиций;
- Оперативные сроки поставки под заказ (от 5 рабочих дней);
- Экспресс доставка в любую точку России;
- Техническая поддержка проекта, помощь в подборе аналогов, поставка прототипов;
- Система менеджмента качества сертифицирована по Международному стандарту ISO 9001;
- Лицензия ФСБ на осуществление работ с использованием сведений, составляющих государственную тайну;
- Поставка специализированных компонентов (Xilinx, Altera, Analog Devices, Intersil, Interpoint, Microsemi, Aeroflex, Peregrine, Syfer, Eurofarad, Texas Instrument, Miteq, Cobham, E2V, MA-COM, Hittite, Mini-Circuits, General Dynamics и др.);

Помимо этого, одним из направлений компании «ЭлектроПласт» является направление «Источники питания». Мы предлагаем Вам помощь Конструкторского отдела:

- Подбор оптимального решения, техническое обоснование при выборе компонента;
- Подбор аналогов;
- Консультации по применению компонента;
- Поставка образцов и прототипов;
- Техническая поддержка проекта;
- Защита от снятия компонента с производства.



Как с нами связаться

Телефон: 8 (812) 309 58 32 (многоканальный)

Факс: 8 (812) 320-02-42

Электронная почта: org@eplast1.ru

Адрес: 198099, г. Санкт-Петербург, ул. Калинина, дом 2, корпус 4, литера А.