

E6B2-C

General-purpose Encoder with External Diameter of 40 mm

- Incremental model
- External diameter of 40 mm.
- Resolution of up to 2,000 ppr.



 Be sure to read *Safety Precautions* on page 4.

Ordering Information

Encoders [Refer to *Dimensions* on page 4.]

| Power supply voltage | Output configuration | Resolution (pulses/rotation) | Model |
|----------------------|---------------------------|---|--|
| 5 to 24 VDC | NPN open-collector output | 10, 20, 30, 40, 50, 60, 100, 200, 300, 360, 400, 500, 600 | E6B2-CWZ6C (resolution) 0.5M Example: E6B2-CWZ6C 10P/R 0.5M |
| | | 720, 800, 1,000, 1,024 | |
| | | 1,200, 1,500, 1,800, 2,000 | |
| 12 to 24 VDC | PNP open-collector output | 100, 200, 360, 500, 600 | E6B2-CWZ5B (resolution) 0.5M Example: E6B2-CWZ5B 100P/R 0.5M |
| | | 1,000 | |
| | | 2,000 | |
| 5 to 12 VDC | Voltage output | 10, 20, 30, 40, 50, 60, 100, 200, 300, 360, 400, 500, 600 | E6B2-CWZ3E (resolution) 0.5M Example: E6B2-CWZ3E 10P/R 0.5M |
| | | 1,000 | |
| | | 1,200, 1,500, 1,800, 2,000 | |
| 5 VDC | Line-driver output | 10, 20, 30, 40, 50, 60, 100, 200, 300, 360, 400, 500, 600 | E6B2-CWZ1X (resolution) 0.5M Example: E6B2-CWZ1X 10P/R 0.5M |
| | | 1,000, 1,024 | |
| | | 1,200, 1,500, 1,800, 2,000 | |

Accessories (Order Separately) [Refer to *Dimensions* on *Rotary Encoder Accessories*.]

| Name | Model | Remarks |
|------------------------|------------------|--|
| Couplings | E69-C06B | Provided with the product. |
| | E69-C68B | Different end diameter |
| | E69-C610B | Different end diameter |
| | E69-C06M | Metal construction |
| Flanges | E69-FBA | --- |
| | E69-FBA02 | E69-2 Servo Mounting Bracket provided. |
| Servo Mounting Bracket | E69-2 | --- |

Refer to *Accessories* for details.

Ratings and Specifications

| Item | Model | E6B2-CWZ6C | E6B2-CWZ5B | E6B2-CWZ3E | E6B2-CWZ1X |
|----------------------------------|--------|--|---|--|--|
| Power supply voltage | | 5 VDC -5% to 24 VDC +15%, ripple (p-p): 5% max. | 12 VDC -10% to 24 VDC +15%, ripple (p-p): 5% max. | 5 VDC -5% to 12 VDC +10%, ripple (p-p): 5% max. | 5 VDC ±5%, ripple (p-p): 5% max. |
| Current consumption *1 | | 80 mA max. | 100 mA max. | | 160 mA max. |
| Resolution (pulses/rotation) | | 10, 20, 30, 40, 50, 60, 100, 200, 300, 360, 400, 500, 600, 720, 800, 1,000, 1,024, 1,200, 1,500, 1,800, 2,000 | 100, 200, 360, 500, 600, 1,000, 2,000 | 10, 20, 30, 40, 50, 60, 100, 200, 300, 360, 400, 500, 600, 1,000, 1,200, 1,500, 1,800, 2,000 | 10, 20, 30, 40, 50, 60, 100, 200, 300, 360, 400, 500, 600, 1,000, 1,024, 1,200, 1,500, 1,800, 2,000 |
| Output phases | | Phases A, B, and Z | | | Phases A, \bar{A} , B, \bar{B} , Z, and \bar{Z} |
| Phase difference between outputs | | 90°±45° between A and B (1/4 T ± 1/8 T) | | | |
| Output configuration | | NPN open-collector output | PNP open-collector output | Voltage output (NPN output) | Line driver output *2 |
| Output capacity | | Applied voltage: 30 VDC max. Sink current: 35 mA max. Residual voltage: 0.4 V max. (at sink current of 35 mA) | Applied voltage: 30 VDC max. Source current: 35 mA max. Residual voltage: 0.4 V max. (at source current of 35 mA) | Output resistance: 2 kΩ Sink current: 20 mA max. Residual voltage: 0.4 V max. (at sink current of 20 mA) | AM26LS31 equivalent Output current High level: $I_o = -20$ mA Low level: $I_s = 20$ mA Output voltage: $V_o = 2.5$ V min. $V_s = 0.5$ V max. |
| Maximum response frequency *3 | | 100 kHz | 50 kHz | 100 kHz | |
| Rise and fall times of output | | 1 μs max. (Control output voltage: 5 V, Load resistance: 1 kΩ, Cable length: 2 m max.) | 1 μs max. (Cable length: 2 m max., Sink current: 10 mA) | | 0.1 μs max. (Cable length: 2 m max., $I_o = -20$ mA, $I_s = 20$ mA) |
| Starting torque | | 0.98 mN·m max. | | | |
| Moment of inertia | | 1×10 ⁻⁶ kg·m ² max.; 3 × 10 ⁻⁷ kg·m ² max. at 600 P/R max. | | | |
| Shaft loading | Radial | 30 N | | | |
| | Thrust | 20 N | | | |
| Maximum permissible speed | | 6,000 r/min | | | |
| Protection circuits | | Power supply reverse polarity protection, Load short-circuit protection | | | --- |
| Ambient temperature range | | Operating: -10 to 70°C (with no icing), Storage: -25 to 85°C (with no icing) | | | |
| Ambient humidity range | | Operating/Storage: 35% to 85% (with no condensation) | | | |
| Insulation resistance | | 20 MΩ min. (at 500 VDC) between current-carrying parts and case | | | |
| Dielectric strength | | 500 VAC, 50/60 Hz for 1 min between current-carrying parts and case | | | |
| Vibration resistance | | Destruction: 10 to 500 Hz, 150 m/s ² or 2-mm double amplitude for 11 min 3 times each in X, Y, and Z directions | | | |
| Shock resistance | | Destruction: 1,000m/s ² 3 times each in X, Y, and Z directions | | | |
| Degree of protection | | IEC 60529 IP50 | | | |
| Connection method | | Pre-wired Models (Standard cable length: 500 mm) | | | |
| Materials | | Case: ABS, Main unit: Aluminum, Shaft: SUS420J2 | | | |
| Weight (packed state) | | Approx. 100 g | | | |
| Accessories | | Coupling, Hexagonal wrench, Instruction manual | | | |

*1. An inrush current of approximately 9 A will flow for approximately 0.3 ms when the power is turned ON.

*2. The line driver output is a data transmission circuit compatible with RS-422A and long-distance transmission is possible with a twisted-pair cable. The quality is equivalent to AM26LS31.

*3. The maximum electrical response speed is determined by the resolution and maximum response frequency as follows:

$$\text{Maximum electrical response speed (rpm)} = \frac{\text{Maximum response frequency}}{\text{Resolution}} \times 60$$

This means that the E6B2-C Rotary Encoder will not operate electrically if its speed exceeds the maximum electrical response speed.

I/O Circuit Diagrams

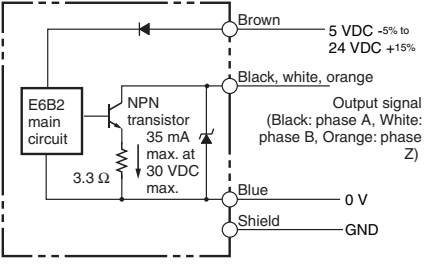
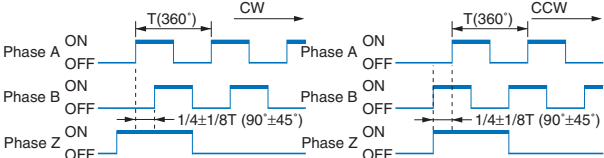
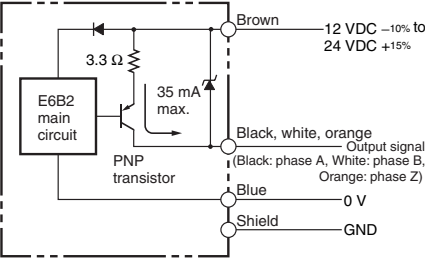
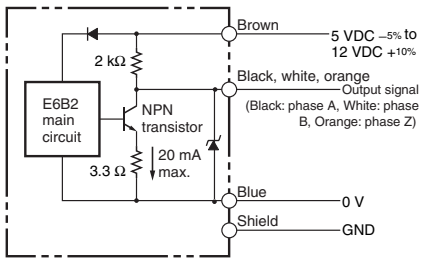
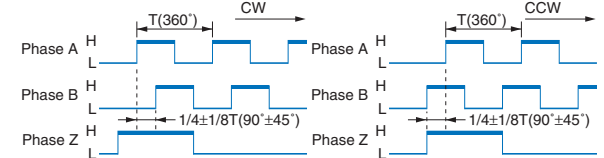
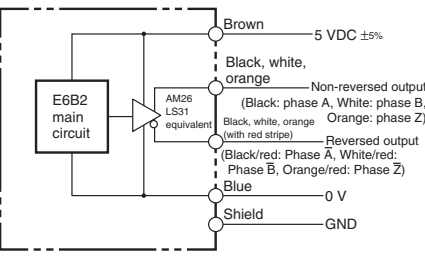
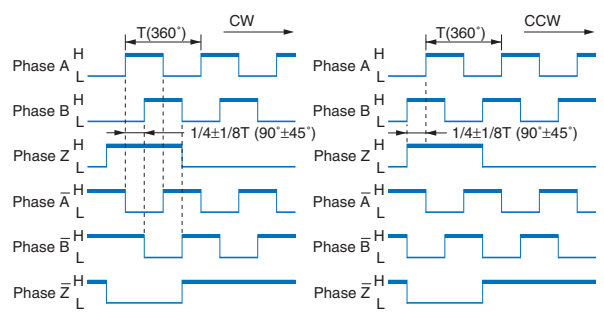
| Model/Output Circuits | Output mode | Connection | | | | | | | | | | | | | | | | | | |
|---|---|---|-------|----------|-------|---------------------|-------|----------------|-------------------|----------------|--------|----------------|-------------------|----------------|--------|----------------|--------------------|----------------|------|--------------|
| <p>E6B2-CWZ6C</p>  <p>5 VDC -5% to 24 VDC $+15\%$</p> <p>Black, white, orange Output signal (Black: phase A, White: phase B, Orange: phase Z)</p> <p>Blue 0 V</p> <p>Shield GND</p> | <p>E6B2-CWZ6C NPN Open-collector Output Model E6B2-CWZ5B PNP Open-collector Output Model</p> <p>Direction of rotation: CW (as viewed from end of shaft) Direction of rotation: CCW (as viewed from end of shaft)</p>  <p>Note: Phase A is $1/4 T \pm 1/8 T$ faster than phase B. The ONs in the above timing chart mean that the output transistor is ON and the OFFs mean that the output transistor is OFF.</p> <p>Note: Phase A is $1/4 T \pm 1/8 T$ slower than phase B.</p> | | | | | | | | | | | | | | | | | | | |
| <p>E6B2-CWZ5B</p>  <p>12 VDC -10% to 24 VDC $+15\%$</p> <p>Black, white, orange Output signal (Black: phase A, White: phase B, Orange: phase Z)</p> <p>Blue 0 V</p> <p>Shield GND</p> | | <table border="1"> <thead> <tr> <th>Color</th> <th>Terminal</th> </tr> </thead> <tbody> <tr> <td>Brown</td> <td>Power supply (+Vcc)</td> </tr> <tr> <td>Black</td> <td>Output phase A</td> </tr> <tr> <td>White</td> <td>Output phase B</td> </tr> <tr> <td>Orange</td> <td>Output phase Z</td> </tr> <tr> <td>Blue</td> <td>0 V (common)</td> </tr> </tbody> </table> | Color | Terminal | Brown | Power supply (+Vcc) | Black | Output phase A | White | Output phase B | Orange | Output phase Z | Blue | 0 V (common) | | | | | | |
| Color | Terminal | | | | | | | | | | | | | | | | | | | |
| Brown | Power supply (+Vcc) | | | | | | | | | | | | | | | | | | | |
| Black | Output phase A | | | | | | | | | | | | | | | | | | | |
| White | Output phase B | | | | | | | | | | | | | | | | | | | |
| Orange | Output phase Z | | | | | | | | | | | | | | | | | | | |
| Blue | 0 V (common) | | | | | | | | | | | | | | | | | | | |
| <p>E6B2-CWZ3E</p>  <p>5 VDC -5% to 12 VDC $+10\%$</p> <p>Black, white, orange Output signal (Black: phase A, White: phase B, Orange: phase Z)</p> <p>Blue 0 V</p> <p>Shield GND</p> | <p>E6B2-CWZ3E Voltage Output Model</p> <p>Direction of rotation: CW (as viewed from end of shaft) Direction of rotation: CCW (as viewed from end of shaft)</p>  <p>Note: Phase A is $1/4 T \pm 1/8 T$ faster than phase B.</p> <p>Note: Phase A is $1/4 T \pm 1/8 T$ slower than phase B.</p> | | | | | | | | | | | | | | | | | | | |
| <p>E6B2-CWZ1X</p>  <p>5 VDC $\pm 5\%$</p> <p>Black, white, orange Non-reversed output (Black: phase A, White: phase B, Orange: phase Z)</p> <p>Black/red stripes Reversed output (Black/red: Phase A, White/red: Phase B, Orange/red: Phase Z)</p> <p>Blue 0 V</p> <p>Shield GND</p> | <p>E6B2-CWZ1X Line Driver Output Model</p> <p>Direction of rotation: CW (as viewed from end of shaft) Direction of rotation: CCW (as viewed from end of shaft)</p>  <p>Note: Receiver: AM26LS32 equivalent</p> | <table border="1"> <thead> <tr> <th>Color</th> <th>Terminal</th> </tr> </thead> <tbody> <tr> <td>Brown</td> <td>Power supply (+Vcc)</td> </tr> <tr> <td>Black</td> <td>Output phase A</td> </tr> <tr> <td>Black/red stripes</td> <td>Output phase A</td> </tr> <tr> <td>White</td> <td>Output phase B</td> </tr> <tr> <td>White/red stripes</td> <td>Output phase B</td> </tr> <tr> <td>Orange</td> <td>Output phase Z</td> </tr> <tr> <td>Orange/red stripes</td> <td>Output phase Z</td> </tr> <tr> <td>Blue</td> <td>0 V (common)</td> </tr> </tbody> </table> | Color | Terminal | Brown | Power supply (+Vcc) | Black | Output phase A | Black/red stripes | Output phase A | White | Output phase B | White/red stripes | Output phase B | Orange | Output phase Z | Orange/red stripes | Output phase Z | Blue | 0 V (common) |
| Color | Terminal | | | | | | | | | | | | | | | | | | | |
| Brown | Power supply (+Vcc) | | | | | | | | | | | | | | | | | | | |
| Black | Output phase A | | | | | | | | | | | | | | | | | | | |
| Black/red stripes | Output phase A | | | | | | | | | | | | | | | | | | | |
| White | Output phase B | | | | | | | | | | | | | | | | | | | |
| White/red stripes | Output phase B | | | | | | | | | | | | | | | | | | | |
| Orange | Output phase Z | | | | | | | | | | | | | | | | | | | |
| Orange/red stripes | Output phase Z | | | | | | | | | | | | | | | | | | | |
| Blue | 0 V (common) | | | | | | | | | | | | | | | | | | | |

- Note: 1. The shielded cable outer core (shield) is not connected to the inner area or to the case.
 2. The phase A, phase B, and phase Z circuits are all identical.
 3. Normally, connect GND to 0 V or to an external ground.

Safety Precautions

Refer to *Warranty and Limitations of Liability*.

⚠ WARNING

This product is not designed or rated for ensuring safety of persons either directly or indirectly. Do not use it for such purposes.



Precautions for Safe Use

Incorrect wiring may damage internal circuits.

Precautions for Correct Use

Do not use the Encoder under ambient conditions that exceed the ratings.

● **Mounting**

● **Origin Indication**

It is easy to adjust the position of phase Z with the origin indication function. The following illustration shows the relationship between phase Z and the origin. Set cut face D to the phase Z origin as shown in the illustration.

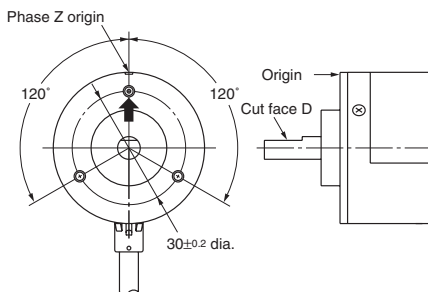

- Do not extend the length of the cable to more than 2 m. If the cable must be more than 2 m, use a Model with a Line-driver Output (max. length: 100 m).

● **Wiring**

Spurious pulses may be generated when power is turned ON and OFF. Wait at least 0.1 s after turning ON the power to the Encoder before using the connected device, and stop using the connected device at least 0.1 s before turning OFF the power to the Encoder. Also, turn ON the power to the load only after turning ON the power to the Encoder.

(Unit: mm)

Dimensions

Tolerance class IT16 applies to dimensions in this datasheet unless otherwise specified.

Encoder

E6B2-C

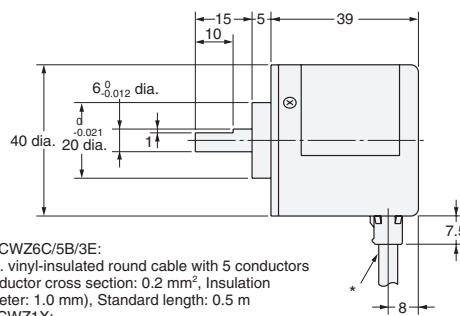
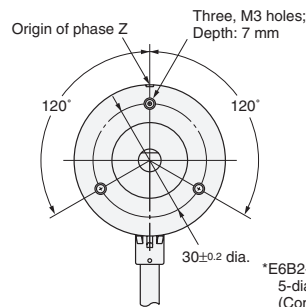
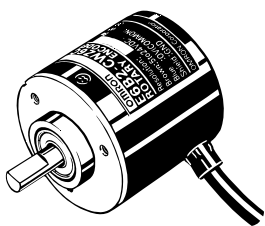

*E6B2-CWZ6C/5B/3E:
5-dia. vinyl-insulated round cable with 5 conductors
(Conductor cross section: 0.2 mm², Insulation diameter: 1.0 mm), Standard length: 0.5 m
E6B2-CWZ1X:
5-dia. vinyl-insulated round cable with 8 conductors
(Conductor cross section: 0.2 mm², Insulation diameter: 1.0 mm), Standard length: 0.5 m

Accessories (Order Separately)

Couplings

- E69-C06B
- E69-C68B
- E69-C610B
- E69-C06M

Flanges

- E69-FBA
- E69-FBA02

Servo Mounting Bracket

- E69-2

Refer to *Accessories* for details.

Read and Understand This Catalog

Please read and understand this catalog before purchasing the products. Please consult your OMRON representative if you have any questions or comments.

Warranty and Limitations of Liability

WARRANTY

OMRON's exclusive warranty is that the products are free from defects in materials and workmanship for a period of one year (or other period if specified) from date of sale by OMRON.

OMRON MAKES NO WARRANTY OR REPRESENTATION, EXPRESS OR IMPLIED, REGARDING NON-INFRINGEMENT, MERCHANTABILITY, OR FITNESS FOR PARTICULAR PURPOSE OF THE PRODUCTS. ANY BUYER OR USER ACKNOWLEDGES THAT THE BUYER OR USER ALONE HAS DETERMINED THAT THE PRODUCTS WILL SUITABLY MEET THE REQUIREMENTS OF THEIR INTENDED USE. OMRON DISCLAIMS ALL OTHER WARRANTIES, EXPRESS OR IMPLIED.

LIMITATIONS OF LIABILITY

OMRON SHALL NOT BE RESPONSIBLE FOR SPECIAL, INDIRECT, OR CONSEQUENTIAL DAMAGES, LOSS OF PROFITS OR COMMERCIAL LOSS IN ANY WAY CONNECTED WITH THE PRODUCTS, WHETHER SUCH CLAIM IS BASED ON CONTRACT, WARRANTY, NEGLIGENCE, OR STRICT LIABILITY.

In no event shall the responsibility of OMRON for any act exceed the individual price of the product on which liability is asserted.

IN NO EVENT SHALL OMRON BE RESPONSIBLE FOR WARRANTY, REPAIR, OR OTHER CLAIMS REGARDING THE PRODUCTS UNLESS OMRON'S ANALYSIS CONFIRMS THAT THE PRODUCTS WERE PROPERLY HANDLED, STORED, INSTALLED, AND MAINTAINED AND NOT SUBJECT TO CONTAMINATION, ABUSE, MISUSE, OR INAPPROPRIATE MODIFICATION OR REPAIR.

Application Considerations

SUITABILITY FOR USE

OMRON shall not be responsible for conformity with any standards, codes, or regulations that apply to the combination of products in the customer's application or use of the products.

At the customer's request, OMRON will provide applicable third party certification documents identifying ratings and limitations of use that apply to the products. This information by itself is not sufficient for a complete determination of the suitability of the products in combination with the end product, machine, system, or other application or use.

The following are some examples of applications for which particular attention must be given. This is not intended to be an exhaustive list of all possible uses of the products, nor is it intended to imply that the uses listed may be suitable for the products:

- Outdoor use, uses involving potential chemical contamination or electrical interference, or conditions or uses not described in this catalog.
- Nuclear energy control systems, combustion systems, railroad systems, aviation systems, medical equipment, amusement machines, vehicles, safety equipment, and installations subject to separate industry or government regulations.
- Systems, machines, and equipment that could present a risk to life or property.

Please know and observe all prohibitions of use applicable to the products.

NEVER USE THE PRODUCTS FOR AN APPLICATION INVOLVING SERIOUS RISK TO LIFE OR PROPERTY WITHOUT ENSURING THAT THE SYSTEM AS A WHOLE HAS BEEN DESIGNED TO ADDRESS THE RISKS, AND THAT THE OMRON PRODUCTS ARE PROPERLY RATED AND INSTALLED FOR THE INTENDED USE WITHIN THE OVERALL EQUIPMENT OR SYSTEM.

PROGRAMMABLE PRODUCTS

OMRON shall not be responsible for the user's programming of a programmable product, or any consequence thereof.

Disclaimers

CHANGE IN SPECIFICATIONS

Product specifications and accessories may be changed at any time based on improvements and other reasons.

It is our practice to change model numbers when published ratings or features are changed, or when significant construction changes are made. However, some specifications of the products may be changed without any notice. When in doubt, special model numbers may be assigned to fix or establish key specifications for your application on your request. Please consult with your OMRON representative at any time to confirm actual specifications of purchased products.

DIMENSIONS AND WEIGHTS

Dimensions and weights are nominal and are not to be used for manufacturing purposes, even when tolerances are shown.

PERFORMANCE DATA

Performance data given in this catalog is provided as a guide for the user in determining suitability and does not constitute a warranty. It may represent the result of OMRON's test conditions, and the users must correlate it to actual application requirements. Actual performance is subject to the OMRON Warranty and Limitations of Liability.

ERRORS AND OMISSIONS

The information in this document has been carefully checked and is believed to be accurate; however, no responsibility is assumed for clerical, typographical, or proofreading errors, or omissions.

2010.8

In the interest of product improvement, specifications are subject to change without notice.

OMRON Corporation
Industrial Automation Company

<http://www.ia.omron.com/>

(c)Copyright OMRON Corporation 2010 All Right Reserved.

Mouser Electronics

Authorized Distributor

Click to View Pricing, Inventory, Delivery & Lifecycle Information:

Omron:

[E6B2-CWZ1X 1000P/R 0.5M](#) [E6B2-CWZ1X 1000P/R 2M](#) [E6B2-CWZ1X 2000P/R 0.5M](#) [E6B2-CWZ1X 500P/R 0.5M](#)
[E6B2-CWZ1X 600P/R 2M](#) [E6B2-CWZ6C 1000P/R 2M](#) [E6B2-CWZ6C 100P/R 0.5M](#) [E6B2-CWZ6C 100P/R 2M](#) [E6B2-](#)
[CWZ6C 2000P/R 0.5M](#) [E6B2-CWZ6C 200P/R 2M](#) [E6B2-CWZ6C 300P/R 0.5M](#) [E6B2-CWZ6C 360P/R 0.5M](#) [E6B2-](#)
[CWZ6C 360P/R 2M](#) [E6B2-CWZ6C 500P/R 2M](#) [E6B2-CWZ6C 600P/R 2M](#) [E6C2-CWZ1X 10P/R 2M](#) [E6C2-CWZ1X](#)
[200P/R 2M](#) [E6C2-CWZ1X 300P/R 2M](#) [E6C2-CWZ1X 50P/R 2M](#) [E6C2-CWZ1X 600P/R 2M](#) [E6B2-CWZ6C-10P/R0.5M](#)
[E6B2-CWZ1X 2000P/R 5M](#) [E6B2-CWZ6C 500P/R 0.5M](#) [E6B2-CWZ6C 200P/R 0.5M](#)



Компания «ЭлектроПласт» предлагает заключение долгосрочных отношений при поставках импортных электронных компонентов на взаимовыгодных условиях!

Наши преимущества:

- Оперативные поставки широкого спектра электронных компонентов отечественного и импортного производства напрямую от производителей и с крупнейших мировых складов;
- Поставка более 17-ти миллионов наименований электронных компонентов;
- Поставка сложных, дефицитных, либо снятых с производства позиций;
- Оперативные сроки поставки под заказ (от 5 рабочих дней);
- Экспресс доставка в любую точку России;
- Техническая поддержка проекта, помощь в подборе аналогов, поставка прототипов;
- Система менеджмента качества сертифицирована по Международному стандарту ISO 9001;
- Лицензия ФСБ на осуществление работ с использованием сведений, составляющих государственную тайну;
- Поставка специализированных компонентов (Xilinx, Altera, Analog Devices, Intersil, Interpoint, Microsemi, Aeroflex, Peregrine, Syfer, Eurofarad, Texas Instrument, Miteq, Cobham, E2V, MA-COM, Hittite, Mini-Circuits, General Dynamics и др.);

Помимо этого, одним из направлений компании «ЭлектроПласт» является направление «Источники питания». Мы предлагаем Вам помощь Конструкторского отдела:

- Подбор оптимального решения, техническое обоснование при выборе компонента;
- Подбор аналогов;
- Консультации по применению компонента;
- Поставка образцов и прототипов;
- Техническая поддержка проекта;
- Защита от снятия компонента с производства.



Как с нами связаться

Телефон: 8 (812) 309 58 32 (многоканальный)

Факс: 8 (812) 320-02-42

Электронная почта: org@eplast1.ru

Адрес: 198099, г. Санкт-Петербург, ул. Калинина, дом 2, корпус 4, литера А.