

Rotary type power switch with encoder



Detector

Slide

Push

Rotary

Power

Dual-in-line Package Type

Push Type

Rocker Type

Slide Type

Rotary Type

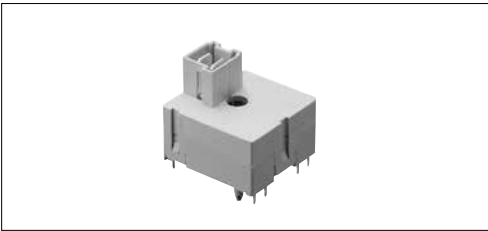

Ratings and Safety Standards

Items	Specifications
Maximum rating (Power)	16(6)A 250V AC 14(6)A 250V AC
Maximum rating (Encoder)	0.1A 12V DC
Contact resistance (Encoder) Initial / after life test	1Ω max. / 1Ω max.
Operating (Power)	10,000 cycles
Operating life (Encoder)	30,000 cycles

Product Line

Circuit arrangement	Torque		Operating direction	Positions	Mounting method	Terminal Configuration	Minimum order unit (pcs.)		Product No.	Drawing No.	
	From 'OFF' position to 'ON' position	Other positions					Japan	Min			
DPST	14±3N	10±3N	Vertical	15	PC board	Straight	288	288	SDKZ1F0200	1	
	12±3N	6±3N		16					SDKZ1G0200		
	14±3N								19	SDKZ1K0200	2
									21	SDKZ1M0200	
									24	SDKZ1Q0200	
									25	SDKZ1R0200	

Packing Specifications

Tray

Number of packages (pcs.)		Export package measurements (mm)
1 case /Japan	1 case /export packing	
288	288	411×311×217

Dimensions

Unit:mm

No.	Style
-----	-------

1

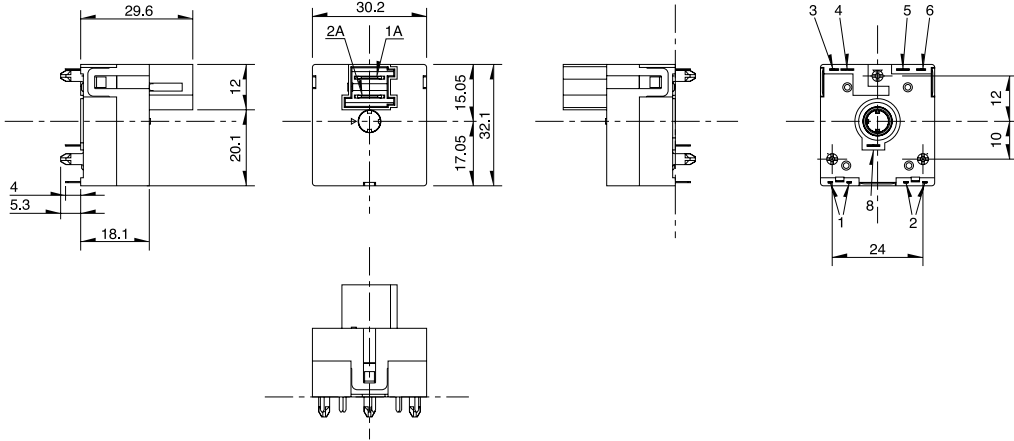

PC board mounting hole dimensions

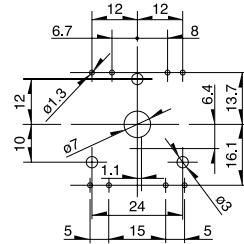

2

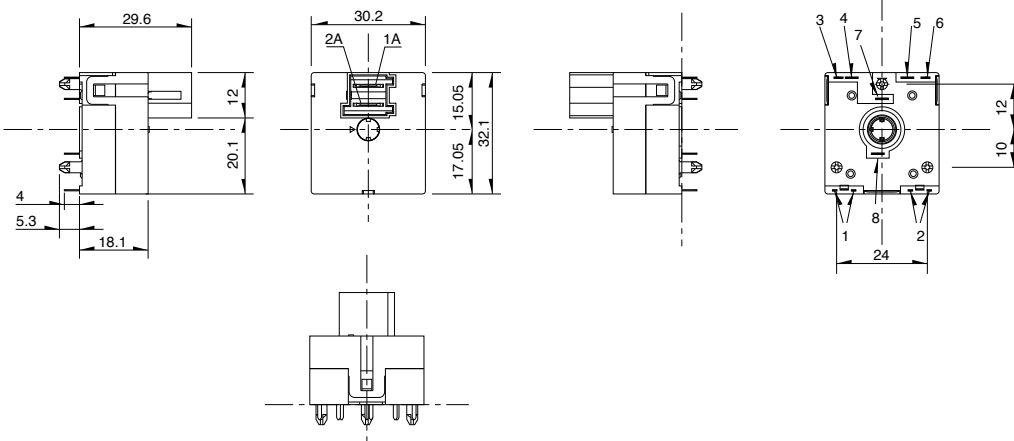

PC board mounting hole dimensions

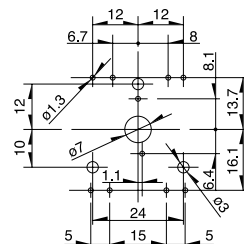

- Detector
- Slide
- Push
- Rotary
- Power
- Dual-In-Line Package Type
- Push Type
- Rocker Type
- Slide Type
- Rotary Type

Standard Code

SDKZ1F0200

Circuit Diagram(Power Switch)

POS	TERM	1	2	3	4	5	6	7	8	9	10	11	12	13	14	15
Power contacts1-2			○	○	○	○	○	○	○	○	○	○	○	○	○	○
Condification contact3		○	○	○	○				○							
Condification contact4		○	○								○	○	○	○	○	○
Condification contact5		○	○	○						○	○	○				
Condification contact6		○			○	○						○	○			○

SDKZ1G0200

Circuit Diagram(Power Switch)

POS	TERM	1	2	3	4	5	6	7	8	9	10	11	12	13	14	15	16
Power contacts1-2			○	○	○	○	○	○	○	○	○	○	○	○	○	○	○
Condification contact3		○	○	○	○					○	○			○	○		
Condification contact4		○	○														○
Condification contact5		○	○	○										○	○	○	○
Condification contact6		○			○	○							○	○	○		

SDKZ1K0200

Circuit Diagram(Power Switch)

POS	TERM	1	2	3	4	5	6	7	8	9	10	11	12	13	14	15	16	17	18	19	20	21	22	23	24
Power contacts1-2			○	○	○	○	○	○	○	○	○	○	○	○	○	○	○	○	○	○	○	○	○	○	○
Condification contact3		○	○			○	○	○																	
Condification contact4		○	○																						
Condification contact5		○	○	○																					
Condification contact6		○	○	○																					
Condification contact7					○	○																			

SDKZ1M0200

Circuit Diagram(Power Switch)

POS	TERM	1	2	3	4	5	6	7	8	9	10	11	12	13	14	15	16	17	18	19	20	21	
Power contacts1-2			○	○	○	○	○	○	○	○	○	○	○	○	○	○	○	○	○	○	○	○	○
Condification contact3		○	○	○																			
Condification contact4		○																					
Condification contact5		○	○																				
Condification contact6		○	○	○																			
Condification contact7					○	○																	

SDKZ1Q0200









Circuit Diagram(Power Switch)

POS	TERM	1	2	3	4	5	6	7	8	9	10	11	12	13	14	15	16	17	18	19	20	21	22	23	24
Power contacts1-2			○	○	○	○	○	○	○	○	○	○	○	○	○	○	○	○	○	○	○	○	○	○	○
Condification contact3		○	○			○	○																		
Condification contact4		○	○																						
Condification contact5		○	○	○																					
Condification contact6		○	○	○																					
Condification contact7					○	○																			

SDKZ1R0200

Circuit Diagram(Power Switch)

POS	TERM	1	2	3	4	5	6	7	8	9	10	11	12	13	14	15	16	17	18	19	20	21	22	23	24	25
Power contacts1-2			○	○	○	○	○	○	○	○	○	○	○	○	○	○	○	○	○	○	○	○	○	○	○	○
Condification contact3		○	○			○	○																			
Condification contact4		○																								
Condification contact5		○	○																							
Condification contact6		○	○	○																						
Condification contact7		○	○																							

Type		Rocker	Slide	Rotary	
Series		SDDJF1A	SDKP	SDKZ	SDDE
Photo					
Rating		8A / 128A 250V~ 10 (6) / 250~	5RA 250V AC	PS: 16 (6) A 250V AC 14 (6) A 250V AC DC: 0.1A 12V DC	AC Switch: 1A / 16A 250V ~ DC Switch: 20mA 12V DC Encoders: 0.1A 12V DC
Operating life		10,000cycles 10A 250V AC	100cycles Without load	10,000cycles (Power) 30,000cycles (Encoder) 16A 250V AC (Power) 0.1A 12V DC (Encoder)	AC Switch: 10,000 cycles DC Switch: 10,000 cycles Encoder 30,000 cycles
Travel (mm)		4.6	6	Endless	Push Switches: 1.85mm Encoders: 360° (360° Rotation)
Features		—	—	With Encoders circuit	AC Switch, DC Switch, With Encoder
Operating temperature range		-10°C to +55°C	-10°C to +60°C	-10°C to +70°C	0°C to +85°C
Automotive use		—	—	—	—
Life cycle (availability)					
Electrical performance	Contact resistance	100mΩ max.		100mΩ max. (Power) 1Ω max. (Encoder)	AC Switch: 100mΩ max. DC Switch: 500mΩ max. Encoder: 1Ω max.
	Insulation resistance	500MΩ min. 500V DC		500MΩ min. 500V DC (Power) 100MΩ min. 100V DC (Encoder)	AC Switch: 100MΩ min. 500V DC DC Switch: 100MΩ min. 100V DC Encoder: 100MΩ min. 100V DC
	Voltage proof	2,000V AC for 1minute		2,000V AC for 1minute (Power) 100V AC for 1minute (Encoder)	AC Switch: 2,000V AC for 1 minute DC Switch: 100V AC for 1 minute Encoder: 100V AC for 1 minute
Mechanical performance	Terminal strength	50N for 1minute	10N for 1minute	20N (Power) 5N (Encoder)	AC Switch: 5N for 1 minute DC Switch: 5N for 30s Encoder: 5N for 1 minute
	Actuator strength	Operating direction	25N	50N	—
Perpendicular direction		25N	50N	30N	30N (Retract direction)
Environmental performance	Cold	-20°C 96h		-40°C 240h	
	Dry heat	85°C 96h		85°C 240h	
	Damp heat	40°C, 90 to 95%RH 96h		40°C, 90 to 95%RH 240h	
Page		162	163	164	167

Power Switches Soldering Conditions	168
Power Switches Cautions	168
Power Switches Safety Standard	168

Reference for Hand Soldering

Series	Soldering temperature	Soldering time
SDDJE, SDDJF, SDKP, SDDJF1A, SDKZ, SDDE	350±10℃	3+1/0s
SDKR	300±10℃	3±0.5s

Reference for Dip Soldering

(For PC board terminal types and SDDJF right-angle terminal types)

Series	Dip soldering	
	Soldering temperature	Duration of immersion
SDKR, SDDJE, SDDJF, SDKP, SDKZ, SDDE	260±5℃	10±1s

Power Switches / Cautions

1. The primary power supply switching is subject to the safety regulations, and the provisions differ by each destination. Consult with us for non-standard use cases.
2. An unstable contact may occur if the switch current is lower than 0.5A. For this case, consult with us.
3. These power switches were produced for alternating current. For direct current, consult with us.
4. Applying load to terminals during soldering under certain conditions may cause deformation and electrical property degradation.
5. Avoid use of water-soluble soldering flux, since it may corrode the switches.
6. When soldering twice, wait until the first soldered portion cools to normal temperature. Continuous heating will deform the external portions, loosen or dislodge terminals, or may deteriorate their electrical characteristics.
7. Before soldering switches with locking mechanism, release the locks. If they are soldered without releasing the locks, the soldering heat may deform the locking mechanism.
8. Be sure to release the locks before removing the knobs. Otherwise, the locking mechanism may be broken.
9. Be sure to use the switch with forced travel positioned as close to the total travel as possible.
10. Tighten the mounting screws by applying the specified torque. Tightening with a larger torque than the specified will result in malfunction or breakage of screws.
11. Corrosive gas if generated by peripheral parts of a set, malfunction such as imperfect contact may occur. Thorough investigation shall be required beforehand.
12. Storage
Store the products as delivered at normal temperature and humidity, out of direct sunlight and away from corrosive gases. Use them as soon as possible and no later than six months after delivery. Once the seal is broken, use them as soon as possible.

Power Switches / Safety Standards

1. Safety Standards Outline

Safety standards are established by a country or an organization representing it to protect general users from electrical shock and fire hazards. It establishes standards for electrical devices and components. For electrical equipment manufacturers, utilizing switches that have been safety-approved ensures the safety of the switch. The use of a safety-approved switch also simplifies at least one part of the process of obtaining certification by safety testing.

2. Major Safety Standards

(1) Electrical Appliance and Material Safety Law

The conventional [Electrical Appliance and Material Control Law] has changed to [Electrical Appliance and Material Safety Law] and has been enforced since April 1, 2001. Electrical appliances are categorized into special electric appliances and parts (formerly Class A) and Electrical appliances other than the special electric appliances (formerly Class B). Special electric appliances are required to receive goodness of fit test at a certified test agency and to store the certificate. Also, penal provisions have been reinforced.

(2) UL (Underwriters Laboratories Inc.)

Underwriters Laboratories Inc. (UL) is the American safety approving organization. Its purpose is to ensure consumer safety and protect them from fire hazards. State law requires that equipment to be exported to the United States utilize UL approved power switches or power switches meeting UL standards and capable of passing UL tests.



Компания «ЭлектроПласт» предлагает заключение долгосрочных отношений при поставках импортных электронных компонентов на взаимовыгодных условиях!

Наши преимущества:

- Оперативные поставки широкого спектра электронных компонентов отечественного и импортного производства напрямую от производителей и с крупнейших мировых складов;
- Поставка более 17-ти миллионов наименований электронных компонентов;
- Поставка сложных, дефицитных, либо снятых с производства позиций;
- Оперативные сроки поставки под заказ (от 5 рабочих дней);
- Экспресс доставка в любую точку России;
- Техническая поддержка проекта, помощь в подборе аналогов, поставка прототипов;
- Система менеджмента качества сертифицирована по Международному стандарту ISO 9001;
- Лицензия ФСБ на осуществление работ с использованием сведений, составляющих государственную тайну;
- Поставка специализированных компонентов (Xilinx, Altera, Analog Devices, Intersil, Interpoint, Microsemi, Aeroflex, Peregrine, Syfer, Eurofarad, Texas Instrument, Miteq, Cobham, E2V, MA-COM, Hittite, Mini-Circuits, General Dynamics и др.);

Помимо этого, одним из направлений компании «ЭлектроПласт» является направление «Источники питания». Мы предлагаем Вам помощь Конструкторского отдела:

- Подбор оптимального решения, техническое обоснование при выборе компонента;
- Подбор аналогов;
- Консультации по применению компонента;
- Поставка образцов и прототипов;
- Техническая поддержка проекта;
- Защита от снятия компонента с производства.



Как с нами связаться

Телефон: 8 (812) 309 58 32 (многоканальный)

Факс: 8 (812) 320-02-42

Электронная почта: org@eplast1.ru

Адрес: 198099, г. Санкт-Петербург, ул. Калинина, дом 2, корпус 4, литера А.