

XPT IGBT Module

preliminary

$$V_{CES} = 2 \times 1200V$$

$$I_{C25} = 360A$$

$$V_{CE(sat)} = 1.8V$$

Phase leg + free wheeling Diodes + NTC

Part number

MIXA225PF1200TSF

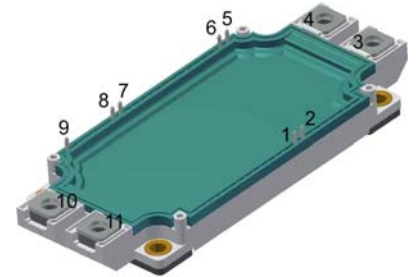

Backside: isolated

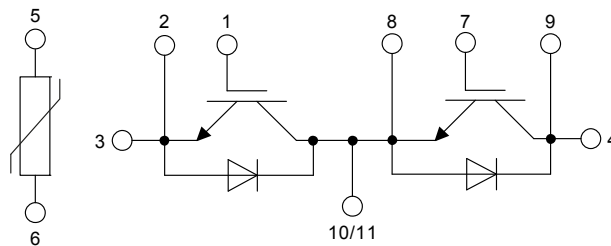

Features / Advantages:

- High level of integration - only one power semiconductor module required for the whole drive
- Rugged XPT design (Xtreme light Punch Through) results in:
 - short circuit rated for 10 μ sec.
 - very low gate charge
 - low EMI
 - square RBSOA @ 3x I_c
- Thin wafer technology combined with the XPT design results in a competitive low $V_{CE(sat)}$
- Temperature sense included
- SONIC™ diode
 - fast and soft reverse recovery
 - low operating forward voltage

Applications:

- AC motor drives
- Pumps, Fans
- Air-conditioning system
- Inverter and power supplies
- UPS

Package: SimBus F

- Isolation Voltage: 3000V~
- Industry standard outline
- RoHS compliant
- Soldering pins for PCB mounting
- Height: 17 mm
- Base plate: Copper internally DCB isolated
- Advanced power cycling

IGBT				Ratings			
Symbol	Definition	Conditions	min.	typ.	max.	Unit	
V_{CES}	collector emitter voltage	$T_{VJ} = 25^{\circ}C$			1200	V	
V_{GES}	max. DC gate voltage				± 20	V	
V_{GEM}	max. transient gate emitter voltage				± 30	V	
I_{C25}	collector current	$T_C = 25^{\circ}C$			360	A	
I_{C80}		$T_C = 80^{\circ}C$			250	A	
P_{tot}	total power dissipation	$T_C = 25^{\circ}C$			1100	W	
$V_{CE(sat)}$	collector emitter saturation voltage	$I_C = 225A; V_{GE} = 15V$		1.8	2.1	V	
				2.1		V	
$V_{GE(th)}$	gate emitter threshold voltage	$I_C = 9mA; V_{GE} = V_{CE}$	5.4	5.9	6.5	V	
I_{CES}	collector emitter leakage current	$V_{CE} = V_{CES}; V_{GE} = 0V$			0.3	mA	
				0.3		mA	
I_{GES}	gate emitter leakage current	$V_{GE} = \pm 20V$			1.5	μA	
$Q_{G(on)}$	total gate charge	$V_{CE} = 600V; V_{GE} = 15V; I_C = 225A$		690		nC	
$t_{d(on)}$	turn-on delay time	inductive load $V_{CE} = 600V; I_C = 225A$ $V_{GE} = \pm 15V; R_G = 3.3\Omega$		60		ns	
t_r	current rise time		$T_{VJ} = 125^{\circ}C$	70		ns	
$t_{d(off)}$	turn-off delay time		280		ns		
t_f	current fall time		310		ns		
E_{on}	turn-on energy per pulse		20		mJ		
E_{off}	turn-off energy per pulse		27		mJ		
RBSOA	reverse bias safe operating area	$V_{GE} = \pm 15V; R_G = 3.3\Omega$					
I_{CM}		$V_{CEmax} = 1200V$			500	A	
SCSOA	short circuit safe operating area	$V_{CEmax} = 1200V$					
t_{sc}	short circuit duration	$V_{CE} = 900V; V_{GE} = \pm 15V$			10	μs	
I_{sc}	short circuit current	$R_G = 3.3\Omega; \text{non-repetitive}$		900		A	
R_{thJC}	thermal resistance junction to case				0.115	K/W	
R_{thCH}	thermal resistance case to heatsink				0.05	K/W	
Diode							
V_{RRM}	max. repetitive reverse voltage	$T_{VJ} = 25^{\circ}C$			1200	V	
I_{F25}	forward current	$T_C = 25^{\circ}C$			265	A	
I_{F80}		$T_C = 80^{\circ}C$			185	A	
V_F	forward voltage	$I_F = 225A$			2.10	V	
				1.70		V	
I_R	reverse current	$V_R = V_{RRM}$			*	mA	
	* not applicable, see Ices value above				*	mA	
Q_{rr}	reverse recovery charge	$V_R = 600V$ $-di_F/dt = 3300A/\mu s$ $I_F = 225A; V_{GE} = 0V$		32		μC	
I_{RM}	max. reverse recovery current		$T_{VJ} = 125^{\circ}C$	250		A	
t_{rr}	reverse recovery time		340		ns		
E_{rec}	reverse recovery energy		11.7		mJ		
R_{thJC}	thermal resistance junction to case				0.145	K/W	
R_{thCH}	thermal resistance case to heatsink				0.05	K/W	

preliminary

Package SimBus F		Ratings				
Symbol	Definition	Conditions	min.	typ.	max.	Unit
I_{RMS}	RMS current	per terminal				A
T_{stg}	storage temperature		-40		125	°C
T_{VJ}	virtual junction temperature		-40		150	°C
Weight				350		g
M_D	mounting torque		3		6	Nm
M_T	terminal torque		3		6	Nm
$d_{Spp/App}$	creepage distance on surface striking distance through air	terminal to terminal	12.7			mm
$d_{Spb/Apb}$		terminal to backside	10.0			mm
V_{ISOL}	isolation voltage	t = 1 second t = 1 minute 50/60 Hz, RMS; $I_{ISOL} \leq 1$ mA	3000 2500			V V
$R_{pin-chip}$	resistance pin to chip	$V = V_{CEsat} + 2 \cdot R \cdot I_C$ resp. $V = V_F + 2 \cdot R \cdot I_F$		0.65		mΩ

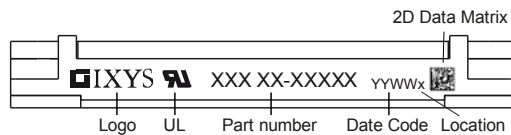

Part number

- M = Module
- I = IGBT
- X = XPT IGBT
- A = Gen 1 / std
- 225 = Current Rating [A]
- PF = Phase leg + free wheeling Diodes
- 1200 = Reverse Voltage [V]
- T = Thermistor \ Temperature sensor
- SF = SimBus F

Ordering	Part Number	Marking on Product	Delivery Mode	Quantity	Code No.
Standard	MIXA225PF1200TSF	MIXA225PF1200TSF	Box	3	512257

Temperature Sensor NTC

Symbol	Definition	Conditions	min.	typ.	max.	Unit
R_{25}	resistance	$T_{VJ} = 25^\circ$	4.75	5	5.25	kΩ
$B_{25/50}$	temperature coefficient			3375		K

Equivalent Circuits for Simulation

* on die level

$T_{VJ} = 150^\circ\text{C}$

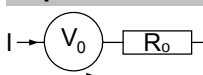

		IGBT	Diode	Unit
$V_{0\ max}$	threshold voltage	1.1	1.19	V
$R_{0\ max}$	slope resistance *	6	8.9	mΩ

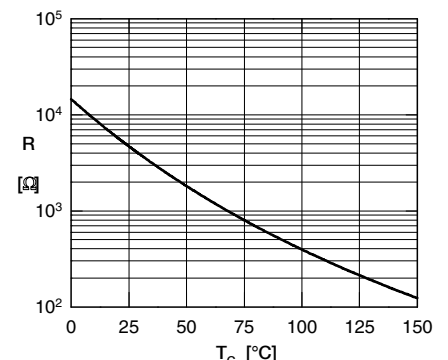

Typ. NTC resistance vs. temperature

Outlines SimBus F

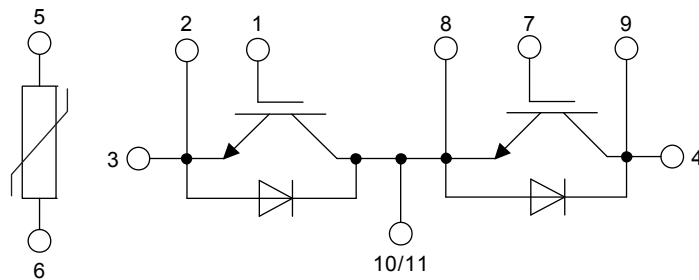
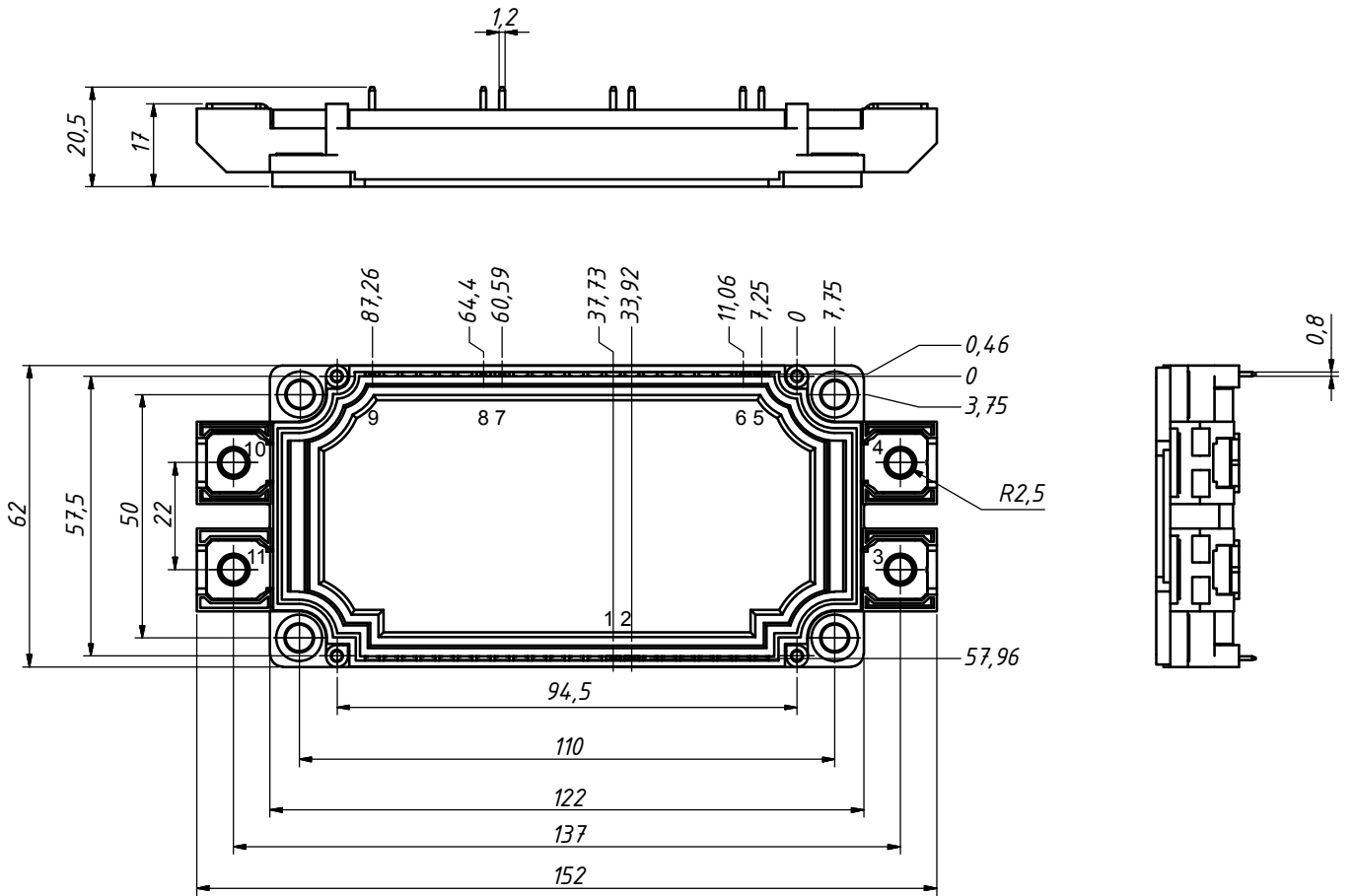

IGBT

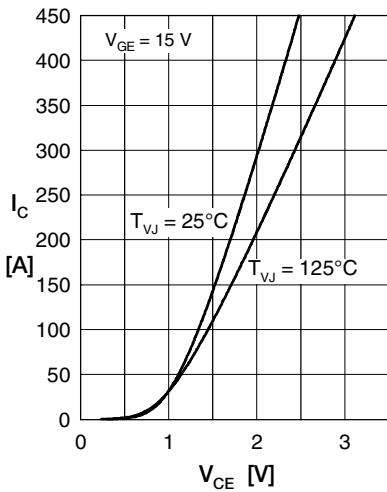

Fig. 1 Typ. output characteristics

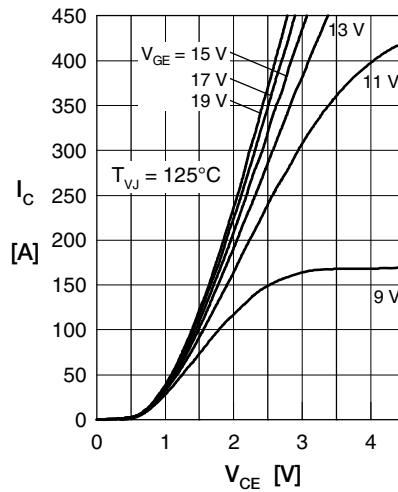

Fig. 2 Typ. output characteristics

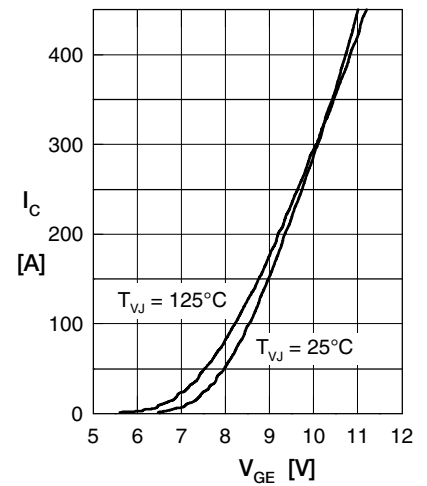

Fig. 3 Typ. transfer characteristics

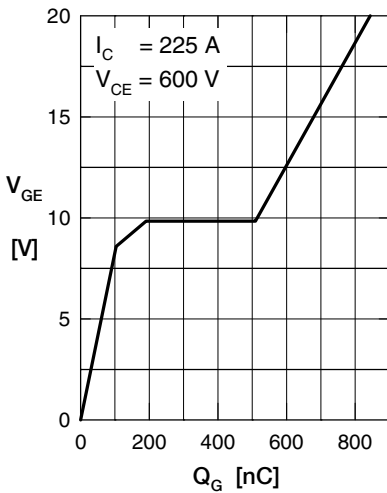

Fig. 4 Typ. turn-on gate charge

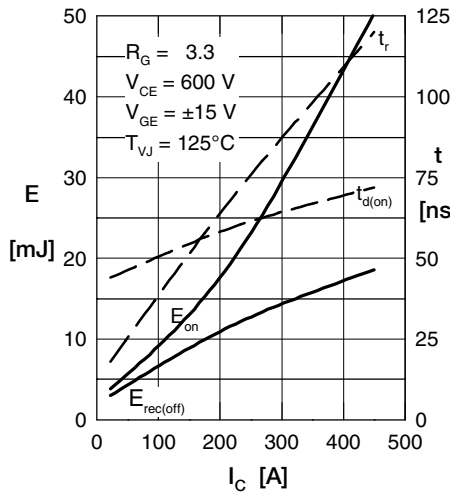

Fig. 5 Typ. switching energy versus collector current

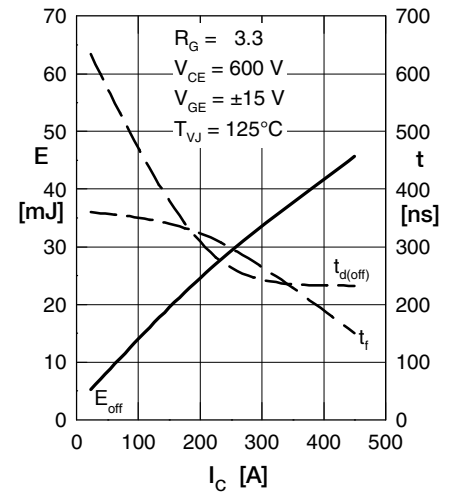

Fig. 6 Typ. switching energy versus collector current

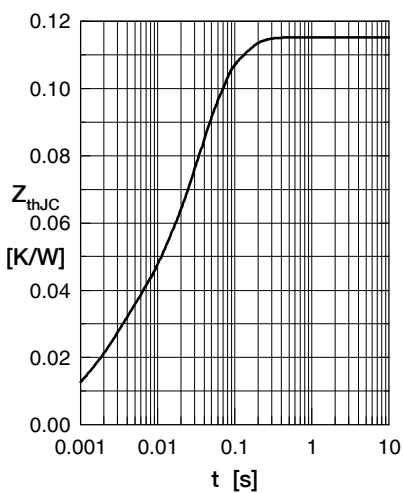

Fig. 7 Typical transient thermal impedance junction to case

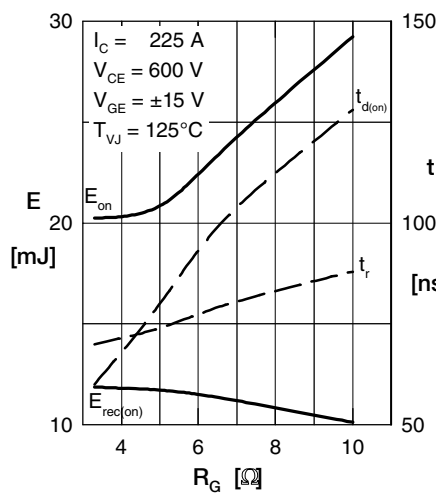

Fig. 8 Typ. switching energy versus gate resistance

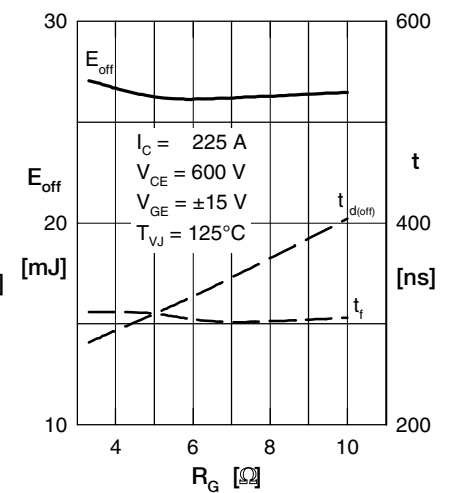

Fig. 9 Typ. switching energy versus gate resistance

Diode

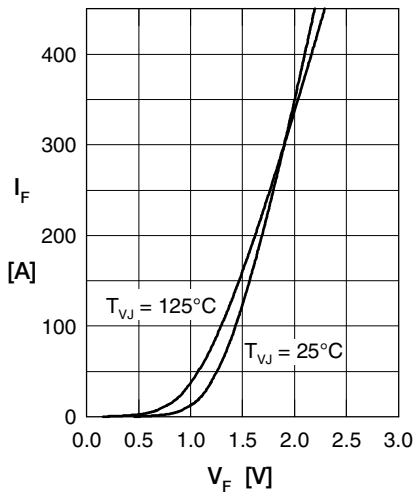

Fig. 1 Typ. forward current versus V_F

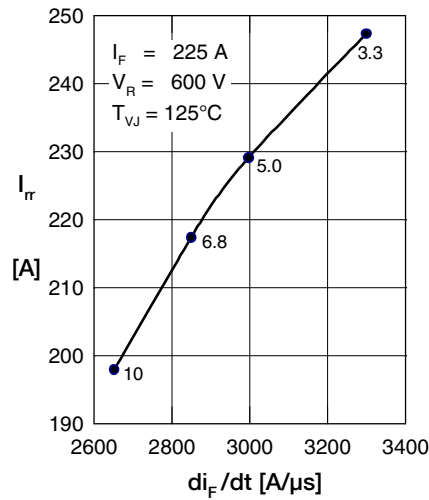

Fig. 2 Typ. reverse recovery characteristics

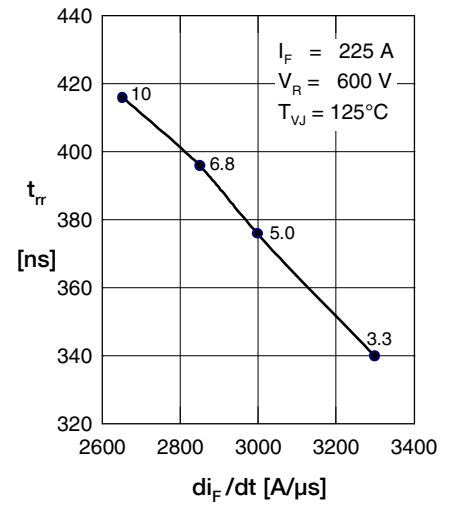

Fig. 3 Typ. reverse recovery characteristics

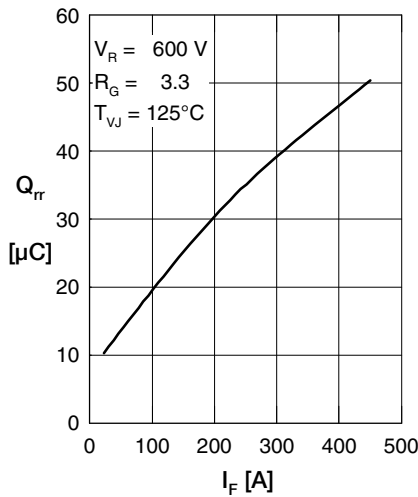

Fig. 4 Typ. reverse recovery characteristics

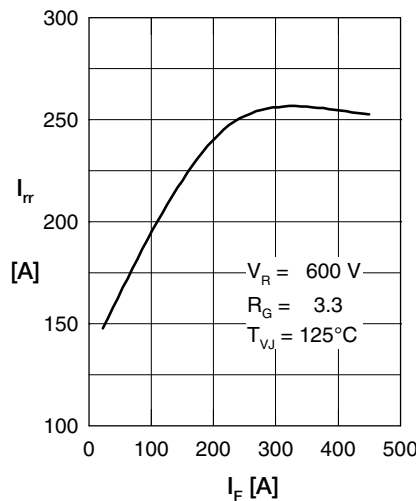

Fig. 5 Typ. reverse recovery characteristics

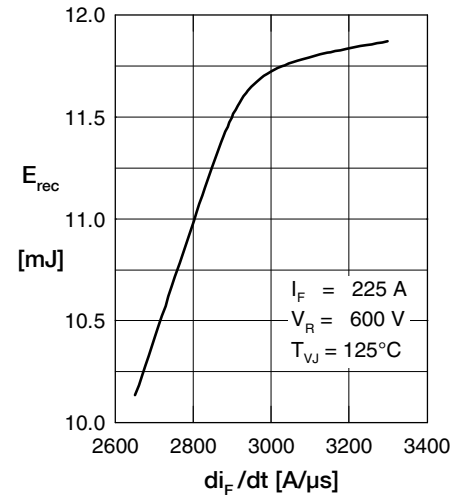

Fig. 6 Typ. recovery energy E_{rec} versus di_F/dt

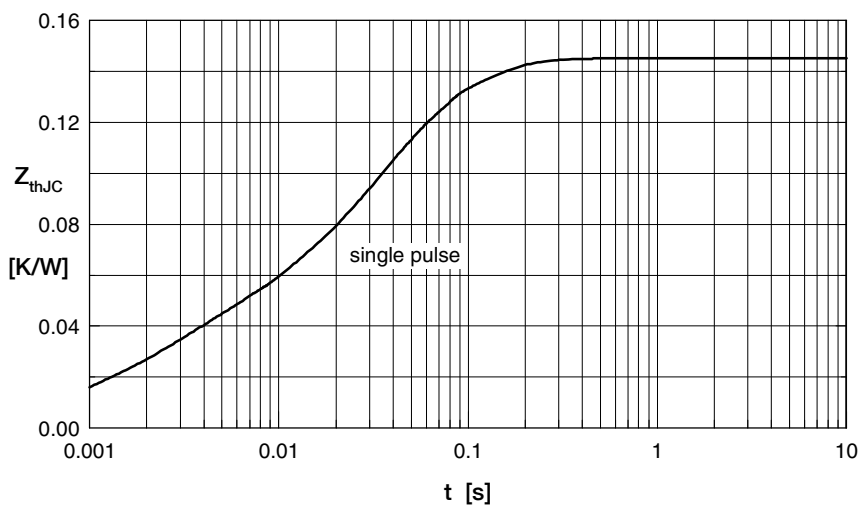

Fig. 7 Typ. transient thermal impedance junction to case



Компания «ЭлектроПласт» предлагает заключение долгосрочных отношений при поставках импортных электронных компонентов на взаимовыгодных условиях!

Наши преимущества:

- Оперативные поставки широкого спектра электронных компонентов отечественного и импортного производства напрямую от производителей и с крупнейших мировых складов;
- Поставка более 17-ти миллионов наименований электронных компонентов;
- Поставка сложных, дефицитных, либо снятых с производства позиций;
- Оперативные сроки поставки под заказ (от 5 рабочих дней);
- Экспресс доставка в любую точку России;
- Техническая поддержка проекта, помощь в подборе аналогов, поставка прототипов;
- Система менеджмента качества сертифицирована по Международному стандарту ISO 9001;
- Лицензия ФСБ на осуществление работ с использованием сведений, составляющих государственную тайну;
- Поставка специализированных компонентов (Xilinx, Altera, Analog Devices, Intersil, Interpoint, Microsemi, Aeroflex, Peregrine, Syfer, Eurofarad, Texas Instrument, Miteq, Cobham, E2V, MA-COM, Hittite, Mini-Circuits, General Dynamics и др.);

Помимо этого, одним из направлений компании «ЭлектроПласт» является направление «Источники питания». Мы предлагаем Вам помощь Конструкторского отдела:

- Подбор оптимального решения, техническое обоснование при выборе компонента;
- Подбор аналогов;
- Консультации по применению компонента;
- Поставка образцов и прототипов;
- Техническая поддержка проекта;
- Защита от снятия компонента с производства.



Как с нами связаться

Телефон: 8 (812) 309 58 32 (многоканальный)

Факс: 8 (812) 320-02-42

Электронная почта: org@eplast1.ru

Адрес: 198099, г. Санкт-Петербург, ул. Калинина, дом 2, корпус 4, литера А.