

## 500 mA Synchronous Buck Regulator, + 300 mA LDO

### Features

- Dual-Output Regulator (500 mA Buck Regulator and 300 mA Low-Dropout Regulator (LDO))
- Total Device Quiescent Current = 57  $\mu$ A (Typical)
- Independent Shutdown for Buck and LDO Outputs
- Both Outputs Internally Compensated
- Synchronous Buck Regulator:
  - Over 90% Typical Efficiency
  - 2.0 MHz Fixed-Frequency PWM (Heavy Load)
  - Low Output Noise
  - Automatic PWM-to-PFM mode transition
  - Adjustable (0.8V to 4.5V) and Standard Fixed-Output Voltages (0.8V, 1.2V, 1.5V, 1.8V, 2.5V, 3.3V)
- Low-Dropout Regulator:
  - Low-Dropout Voltage = 137 mV Typical @ 200 mA
  - Standard Fixed-Output Voltages (1.5V, 1.8V, 2.5V, 3.3V)
- Small 10-pin 3x3 DFN or MSOP Package Options
- Operating Junction Temperature Range:
  - -40°C to +125°C
- Undervoltage Lockout (UVLO)
- Output Short Circuit Protection
- Overtemperature Protection

### Applications

- Cellular Phones
- Portable Computers
- USB-Powered Devices
- Handheld Medical Instruments
- Organizers and PDAs

### Description

The TC1313 device combines a 500 mA synchronous buck regulator and 300 mA Low-Dropout Regulator (LDO) to provide a highly integrated solution for devices that require multiple supply voltages. The unique combination of an integrated buck switching regulator and low-dropout linear regulator provides the lowest system cost for dual-output voltage applications that require one lower processor core voltage and one higher bias voltage.

The 500 mA synchronous buck regulator switches at a fixed frequency of 2.0 MHz when the load is heavy, providing a low-noise, small-size solution. When the load on the buck output is reduced to light levels, it changes operation to a Pulse Frequency Modulation (PFM) mode to minimize quiescent current draw from the battery. No intervention is necessary for smooth transition from one mode to another.

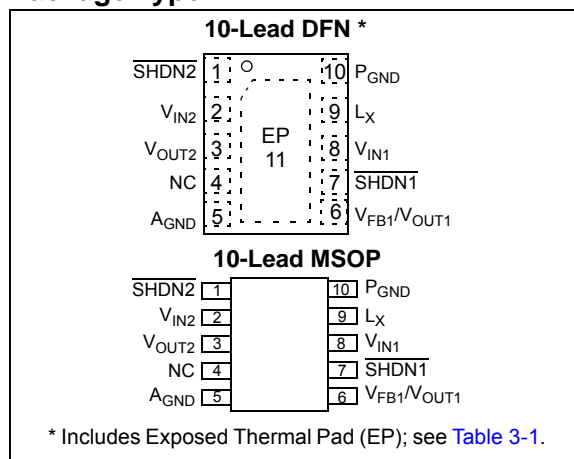
The LDO provides a 300 mA auxiliary output that requires a single 1  $\mu$ F ceramic output capacitor, minimizing board area and cost. The typical dropout voltage for the LDO output is 137 mV for a 200 mA load.

The TC1313 device is available in either the 10-pin DFN or MSOP package.

Additional protection features include: UVLO, overtemperature and overcurrent protection on both outputs.

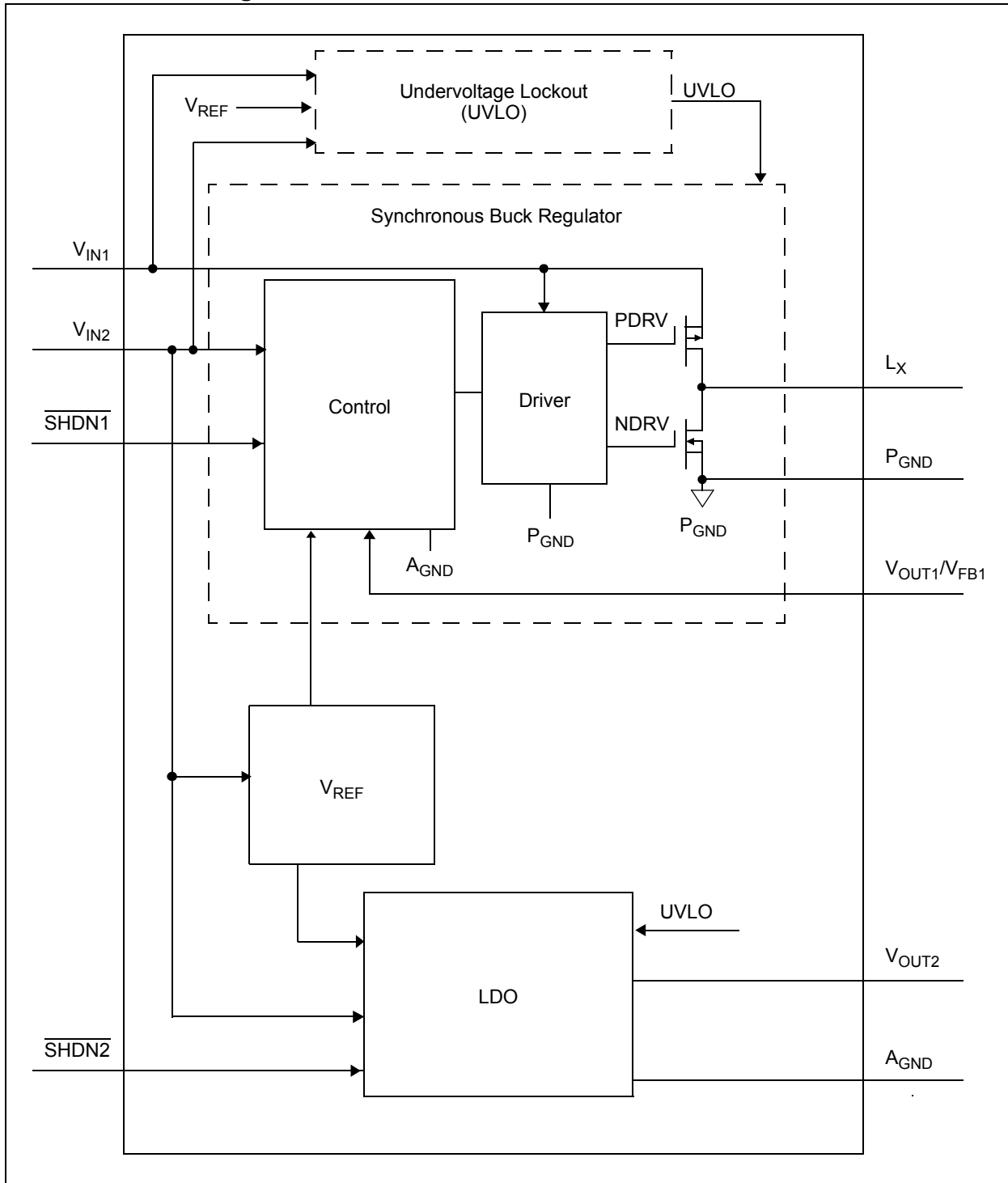
For a complete listing of TC1313 standard parts, consult your Microchip representative.

### Package Type

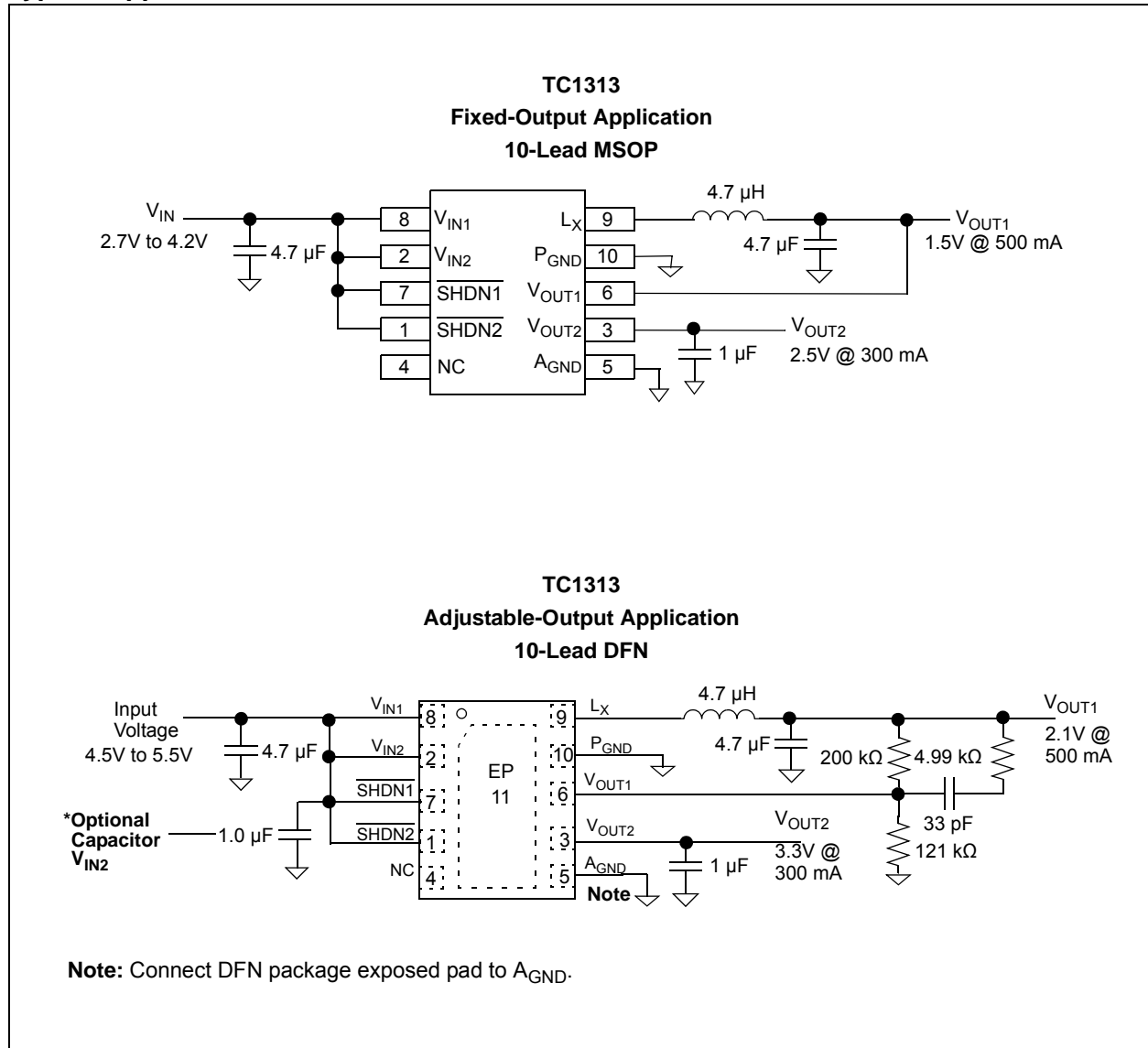


# TC1313

## Functional Block Diagram



## Typical Application Circuits



# TC1313

---

NOTES:

## 1.0 ELECTRICAL CHARACTERISTICS

### Absolute Maximum Ratings †

$V_{IN} - A_{GND}$ .....	6.0V
All Other I/O .....	( $A_{GND} - 0.3V$ ) to ( $V_{IN} + 0.3V$ )
$L_X$ to $P_{GND}$ .....	-0.3V to ( $V_{IN} + 0.3V$ )
$P_{GND}$ to $A_{GND}$ .....	-0.3V to +0.3V
Output Short Circuit Current .....	Continuous
Power Dissipation ( <b>Note 7</b> ).....	Internally Limited
Storage temperature .....	-65°C to +150°C
Ambient Temp. with Power Applied .....	-40°C to +85°C
Operating Junction Temperature.....	-40°C to +125°C
ESD protection on all pins (HBM) .....	3 kV

† **Notice:** Stresses above those listed under “Maximum Ratings” may cause permanent damage to the device. This is a stress rating only and functional operation of the device at those or any other conditions above those indicated in the operational listings of this specification is not implied. Exposure to maximum rating conditions for extended periods may affect device reliability.

### DC CHARACTERISTICS

**Electrical Characteristics:**  $V_{IN1} = V_{IN2} = SHDN1,2 = 3.6V$ ,  $C_{OUT1} = C_{IN} = 4.7 \mu F$ ,  $C_{OUT2} = 1 \mu F$ ,  $L = 4.7 \mu H$ ,  $V_{OUT1} (ADJ) = 1.8V$ ,  $I_{OUT1} = 100 \text{ ma}$ ,  $I_{OUT2} = 0.1 \text{ mA}$   $T_A = +25^\circ C$ . **Boldface** specifications apply over the  $T_A$  range of **-40°C to +85°C**.

Parameters	Sym	Min	Typ	Max	Units	Conditions
<b>Input/Output Characteristics</b>						
Input Voltage	$V_{IN}$	<b>2.7</b>	—	<b>5.5</b>	V	<b>Note 1, Note 2, Note 8</b>
Maximum Output Current	$I_{OUT1\_MAX}$	<b>500</b>	—	—	mA	<b>Note 1</b>
Maximum Output Current	$I_{OUT2\_MAX}$	<b>300</b>	—	—	mA	<b>Note 1</b>
Shutdown Current Combined $V_{IN1}$ and $V_{IN2}$ Current	$I_{IN\_SHDN}$	—	0.05	<b>1</b>	$\mu A$	$SHDN1 = SHDN2 = GND$
Operating $I_Q$	$I_Q$	—	57	<b>100</b>	$\mu A$	$SHDN1 = SHDN2 = V_{IN2}$ $I_{OUT1} = 0 \text{ mA}$ , $I_{OUT2} = 0 \text{ mA}$
Synchronous Buck $I_Q$		—	38	—	$\mu A$	$SHDN1 = V_{IN}$ , $SHDN2 = GND$
LDO $I_Q$		—	44	—	$\mu A$	$SHDN1 = GND$ , $SHDN2 = V_{IN2}$
<b>Shutdown/UVLO/Thermal Shutdown Characteristics</b>						
$SHDN1, SHDN2$ , Logic Input Voltage Low	$V_{IL}$	—	—	<b>15</b>	% $V_{IN}$	$V_{IN1} = V_{IN2} = 2.7V$ to $5.5V$
$SHDN1, SHDN2$ , Logic Input Voltage High	$V_{IH}$	<b>45</b>	—	—	% $V_{IN}$	$V_{IN1} = V_{IN2} = 2.7V$ to $5.5V$
$SHDN1, SHDN2$ , Input Leakage Current	$I_{IN}$	<b>-1.0</b>	$\pm 0.01$	<b>1.0</b>	$\mu A$	$V_{IN1} = V_{IN2} = 2.7V$ to $5.5V$ $SHDNX = GND$ $SHDNY = V_{IN}$
Thermal Shutdown	$T_{SHD}$	—	165	—	°C	<b>Note 6, Note 7</b>
Thermal Shutdown Hysteresis	$T_{SHD-HYS}$	—	10	—	°C	
Undervoltage Lockout ( $V_{OUT1}$ and $V_{OUT2}$ )	UVLO	<b>2.4</b>	2.55	<b>2.7</b>	V	$V_{IN1}$ Falling
Undervoltage Lockout Hysteresis	UVLO-HYS	—	200	—	mV	

- Note 1:** The Minimum  $V_{IN}$  has to meet two conditions:  $V_{IN} \geq 2.7V$  and  $V_{IN} \geq V_{RX} + V_{DROPOUT}$ ,  $V_{RX} = V_{R1}$  or  $V_{R2}$ .
- 2:**  $V_{RX}$  is the regulator output voltage setting.
- 3:**  $TCV_{OUT2} = ((V_{OUT2max} - V_{OUT2min}) * 10^6) / (V_{OUT2} * D_T)$ .
- 4:** Regulation is measured at a constant junction temperature using low duty cycle pulse testing. Load regulation is tested over a load range from 0.1 mA to the maximum specified output current.
- 5:** Dropout voltage is defined as the input-to-output voltage differential at which the output voltage drops 2% below its nominal value measured at a 1V differential.
- 6:** The maximum allowable power dissipation is a function of ambient temperature, the maximum allowable junction temperature and the thermal resistance from junction to air. (i.e.  $T_A$ ,  $T_J$ ,  $\theta_{JA}$ ). Exceeding the maximum allowable power dissipation causes the device to initiate thermal shutdown.
- 7:** The integrated MOSFET switches have an integral diode from the  $L_X$  pin to  $V_{IN}$ , and from  $L_X$  to  $P_{GND}$ . In cases where these diodes are forward-biased, the package power dissipation limits must be adhered to. Thermal protection is not able to limit the junction temperature for these cases.
- 8:**  $V_{IN1}$  and  $V_{IN2}$  are supplied by the same input source.

# TC1313

## DC CHARACTERISTICS (CONTINUED)

**Electrical Characteristics:**  $V_{IN1} = V_{IN2} = \overline{\text{SHDN}}_{1,2} = 3.6\text{V}$ ,  $C_{OUT1} = C_{IN} = 4.7\ \mu\text{F}$ ,  $C_{OUT2} = 1\ \mu\text{F}$ ,  $L = 4.7\ \mu\text{H}$ ,  $V_{OUT1} (\text{ADJ}) = 1.8\text{V}$ ,  $I_{OUT1} = 100\ \text{mA}$ ,  $I_{OUT2} = 0.1\ \text{mA}$   $T_A = +25^\circ\text{C}$ . **Boldface** specifications apply over the  $T_A$  range of  $-40^\circ\text{C}$  to  $+85^\circ\text{C}$ .

Parameters	Sym	Min	Typ	Max	Units	Conditions
<b>Synchronous Buck Regulator (<math>V_{OUT1}</math>)</b>						
Adjustable Output Voltage Range	$V_{OUT1}$	<b>0.8</b>	—	<b>4.5</b>	V	
Adjustable Reference Feedback Voltage ( $V_{FB1}$ )	$V_{FB1}$	<b>0.78</b>	0.8	<b>0.82</b>	V	
Feedback Input Bias Current ( $I_{FB1}$ )	$I_{FB1}$	—	-1.5	—	nA	
Output Voltage Tolerance Fixed ( $V_{OUT1}$ )	$V_{OUT1}$	<b>-2.5</b>	$\pm 0.3$	<b>+2.5</b>	%	<b>Note 2</b>
Line Regulation ( $V_{OUT1}$ )	$V_{\text{LINE-REG}}$	—	0.2	—	%/V	$V_{IN} = V_R + 1\text{V}$ to 5.5V, $I_{\text{LOAD}} = 100\ \text{mA}$
Load Regulation ( $V_{OUT1}$ )	$V_{\text{LOAD-REG}}$	—	0.2	—	%	$V_{IN} = V_R + 1.5\text{V}$ , $I_{\text{LOAD}} = 100\ \text{mA}$ to 500 mA ( <b>Note 1</b> )
Dropout Voltage $V_{OUT1}$	$V_{IN} - V_{OUT1}$	—	280	—	mV	$I_{OUT1} = 500\ \text{mA}$ , $V_{OUT1} = 3.3\text{V}$ ( <b>Note 5</b> )
Internal Oscillator Frequency	$F_{\text{OSC}}$	<b>1.6</b>	2.0	<b>2.4</b>	MHz	
Start Up Time	$T_{\text{SS}}$	—	0.5	—	ms	$T_R = 10\%$ to 90%
$R_{\text{DSon}}$ P-Channel	$R_{\text{DSon-P}}$	—	450	—	m $\Omega$	$I_P = 100\ \text{mA}$
$R_{\text{DSon}}$ N-Channel	$R_{\text{DSon-N}}$	—	450	—	m $\Omega$	$I_N = 100\ \text{mA}$
$L_X$ Pin Leakage Current	$I_{LX}$	<b>-1.0</b>	$\pm 0.01$	<b>1.0</b>	$\mu\text{A}$	$\overline{\text{SHDN}} = 0\text{V}$ , $V_{IN} = 5.5\text{V}$ , $L_X = 0\text{V}$ , $L_X = 5.5\text{V}$
Positive Current Limit Threshold	$+I_{LX(\text{MAX})}$	—	700	—	mA	
<b>LDO Output (<math>V_{OUT2}</math>)</b>						
Output Voltage Tolerance ( $V_{OUT2}$ )	$V_{OUT2}$	<b>-2.5</b>	$\pm 0.3$	<b>+2.5</b>	%	<b>Note 2</b>
Temperature Coefficient	$\text{TCV}_{\text{OUT}}$	—	25	—	ppm/ $^\circ\text{C}$	<b>Note 3</b>
Line Regulation	$\frac{\Delta V_{\text{OUT2}}}{\Delta V_{\text{IN}}}$	<b>-0.2</b>	$\pm 0.02$	<b>+0.2</b>	%/V	$(V_R + 1\text{V}) \leq V_{IN} \leq 5.5\text{V}$
Load Regulation, $V_{OUT2} \geq 2.5\text{V}$	$\frac{\Delta V_{\text{OUT2}}}{I_{\text{OUT2}}}$	<b>-0.75</b>	0.1	<b>+0.75</b>	%	$I_{\text{OUT2}} = 0.1\ \text{mA}$ to 300 mA ( <b>Note 4</b> )
Load Regulation, $V_{OUT2} < 2.5\text{V}$	$\frac{\Delta V_{\text{OUT2}}}{I_{\text{OUT2}}}$	<b>-0.90</b>	0.1	<b>+0.90</b>	%	$I_{\text{OUT2}} = 0.1\ \text{mA}$ to 300 mA ( <b>Note 4</b> )
Dropout Voltage $V_{OUT2} > 2.5\text{V}$	$V_{IN} - V_{OUT2}$	—	137	<b>300</b>	mV	$I_{\text{OUT2}} = 200\ \text{mA}$ ( <b>Note 5</b> ) $I_{\text{OUT2}} = 300\ \text{mA}$
Power Supply Rejection Ratio	PSRR	—	62	—	dB	$f = 100\ \text{Hz}$ , $I_{\text{OUT1}} = I_{\text{OUT2}} = 50\ \text{mA}$ , $C_{IN} = 0\ \mu\text{F}$
Output Noise	eN	—	1.8	—	$\mu\text{V}/(\text{Hz})^{1/2}$	$f = 1\ \text{kHz}$ , $I_{\text{OUT2}} = 50\ \text{mA}$ , $\overline{\text{SHDN}} = \text{GND}$

- Note 1:** The Minimum  $V_{IN}$  has to meet two conditions:  $V_{IN} \geq 2.7\text{V}$  and  $V_{IN} \geq V_{RX} + V_{\text{DROPOUT}}$ ,  $V_{RX} = V_{R1}$  or  $V_{R2}$ .
- 2:**  $V_{RX}$  is the regulator output voltage setting.
- 3:**  $\text{TCV}_{\text{OUT2}} = ((V_{\text{OUT2max}} - V_{\text{OUT2min}}) * 10^6) / (V_{\text{OUT2}} * D_T)$ .
- 4:** Regulation is measured at a constant junction temperature using low duty cycle pulse testing. Load regulation is tested over a load range from 0.1 mA to the maximum specified output current.
- 5:** Dropout voltage is defined as the input-to-output voltage differential at which the output voltage drops 2% below its nominal value measured at a 1V differential.
- 6:** The maximum allowable power dissipation is a function of ambient temperature, the maximum allowable junction temperature and the thermal resistance from junction to air. (i.e.  $T_A$ ,  $T_J$ ,  $\theta_{JA}$ ). Exceeding the maximum allowable power dissipation causes the device to initiate thermal shutdown.
- 7:** The integrated MOSFET switches have an integral diode from the  $L_X$  pin to  $V_{IN}$ , and from  $L_X$  to  $P_{\text{GND}}$ . In cases where these diodes are forward-biased, the package power dissipation limits must be adhered to. Thermal protection is not able to limit the junction temperature for these cases.
- 8:**  $V_{IN1}$  and  $V_{IN2}$  are supplied by the same input source.

## DC CHARACTERISTICS (CONTINUED)

<b>Electrical Characteristics:</b> $V_{IN1} = V_{IN2} = \overline{\text{SHDN}}_{1,2} = 3.6\text{V}$ , $C_{OUT1} = C_{IN} = 4.7\ \mu\text{F}$ , $C_{OUT2} = 1\ \mu\text{F}$ , $L = 4.7\ \mu\text{H}$ , $V_{OUT1} (\text{ADJ}) = 1.8\text{V}$ , $I_{OUT1} = 100\ \text{mA}$ , $I_{OUT2} = 0.1\ \text{mA}$ $T_A = +25^\circ\text{C}$ . <b>Boldface</b> specifications apply over the $T_A$ range of <b>-40°C to +85°C</b> .						
Parameters	Sym	Min	Typ	Max	Units	Conditions
Output Short Circuit Current (Average)	$I_{OUTsc2}$	—	240	—	mA	$R_{LOAD2} \leq 1\ \Omega$
Wake-Up Time (From SHDN2 mode), ( $V_{OUT2}$ )	$t_{WK}$	—	31	100	$\mu\text{s}$	$I_{OUT1} = I_{OUT2} = 50\ \text{mA}$
Settling Time (From SHDN2 mode), ( $V_{OUT2}$ )	$t_S$	—	100	—	$\mu\text{s}$	$I_{OUT1} = I_{OUT2} = 50\ \text{mA}$

- Note**
- 1: The Minimum  $V_{IN}$  has to meet two conditions:  $V_{IN} \geq 2.7\text{V}$  and  $V_{IN} \geq V_{RX} + V_{DROPOUT}$ ,  $V_{RX} = V_{R1}$  or  $V_{R2}$ .
  - 2:  $V_{RX}$  is the regulator output voltage setting.
  - 3:  $TCV_{OUT2} = ((V_{OUT2max} - V_{OUT2min}) * 10^6) / (V_{OUT2} * D_T)$ .
  - 4: Regulation is measured at a constant junction temperature using low duty cycle pulse testing. Load regulation is tested over a load range from 0.1 mA to the maximum specified output current.
  - 5: Dropout voltage is defined as the input-to-output voltage differential at which the output voltage drops 2% below its nominal value measured at a 1V differential.
  - 6: The maximum allowable power dissipation is a function of ambient temperature, the maximum allowable junction temperature and the thermal resistance from junction to air. (i.e.  $T_A$ ,  $T_J$ ,  $\theta_{JA}$ ). Exceeding the maximum allowable power dissipation causes the device to initiate thermal shutdown.
  - 7: The integrated MOSFET switches have an integral diode from the  $L_X$  pin to  $V_{IN}$ , and from  $L_X$  to  $P_{GND}$ . In cases where these diodes are forward-biased, the package power dissipation limits must be adhered to. Thermal protection is not able to limit the junction temperature for these cases.
  - 8:  $V_{IN1}$  and  $V_{IN2}$  are supplied by the same input source.

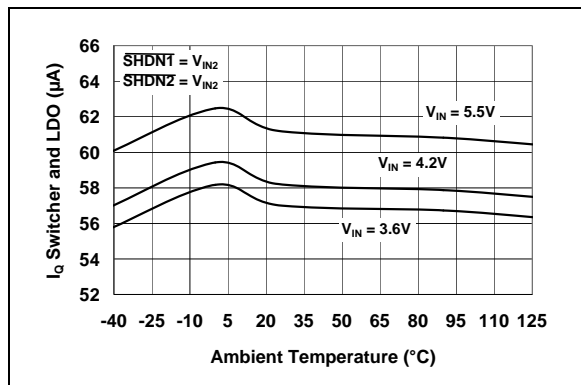
## TEMPERATURE SPECIFICATIONS

<b>Electrical Specifications:</b> Unless otherwise indicated, all limits are specified for: $V_{IN} = +2.7\text{V}$ to $+5.5\text{V}$						
Parameters	Sym	Min	Typ	Max	Units	Conditions
<b>Temperature Ranges</b>						
Operating Junction Temperature Range	$T_J$	-40	—	+125	$^\circ\text{C}$	Steady state
Storage Temperature Range	$T_A$	-65	—	+150	$^\circ\text{C}$	
Maximum Junction Temperature	$T_J$	—	—	+150	$^\circ\text{C}$	Transient
<b>Thermal Package Resistances</b>						
Thermal Resistance, 10L-DFN	$\theta_{JA}$	—	41	—	$^\circ\text{C}/\text{W}$	Typical 4-layer board with Internal Ground Plane and 2 Vias in Thermal Pad
Thermal Resistance, 10L-MSOP	$\theta_{JA}$	—	113	—	$^\circ\text{C}/\text{W}$	Typical 4-layer board with Internal Ground Plane

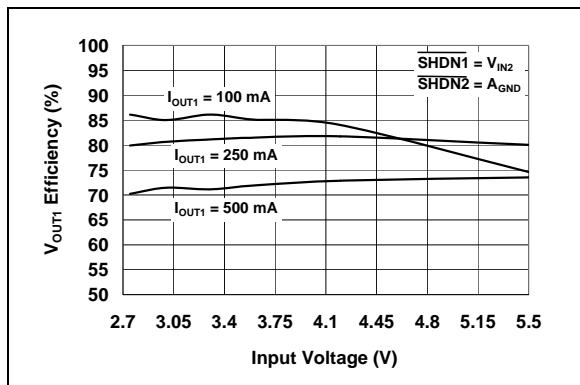
## 2.0 TYPICAL PERFORMANCE CURVES

**Note:** The graphs and tables provided following this note are a statistical summary based on a limited number of samples and are provided for informational purposes only. The performance characteristics listed herein are not tested or guaranteed. In some graphs or tables, the data presented may be outside the specified operating range (e.g., outside specified power supply range) and therefore outside the warranted range.

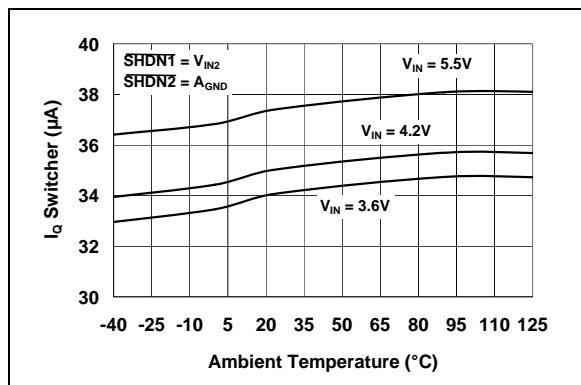
**Note:** Unless otherwise indicated,  $V_{IN1} = V_{IN2} = \overline{\text{SHDN1,2}} = 3.6\text{V}$ ,  $C_{OUT1} = C_{IN} = 4.7\ \mu\text{F}$ ,  $C_{OUT2} = 1\ \mu\text{F}$ ,  $L = 4.7\ \mu\text{H}$ ,  $V_{OUT1}(\text{ADJ}) = 1.8\text{V}$ ,  $T_A = +25^\circ\text{C}$ . **Boldface** specifications apply over the  $T_A$  range of  $-40^\circ\text{C}$  to  $+85^\circ\text{C}$ .  $T_A = +25^\circ\text{C}$ . Adjustable or fixed-output voltage options can be used to generate the Typical Performance Characteristics.



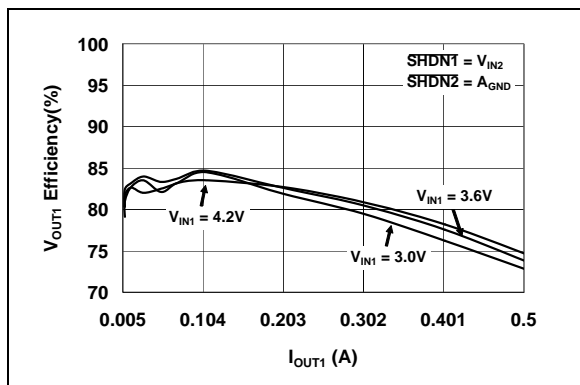
**FIGURE 2-1:**  $I_Q$  Switcher and LDO Current vs. Ambient Temperature.



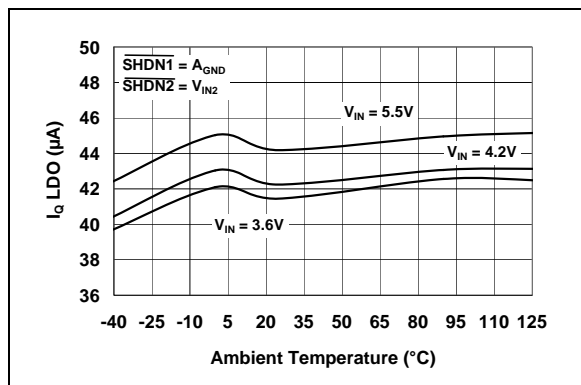
**FIGURE 2-4:**  $V_{OUT1}$  Output Efficiency vs. Input Voltage ( $V_{OUT1} = 1.2\text{V}$ ).



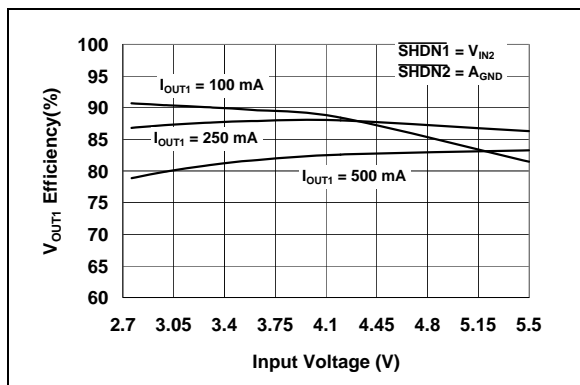
**FIGURE 2-2:**  $I_Q$  Switcher Current vs. Ambient Temperature.



**FIGURE 2-5:**  $V_{OUT1}$  Output Efficiency vs.  $I_{OUT1}$  ( $V_{OUT1} = 1.2\text{V}$ ).



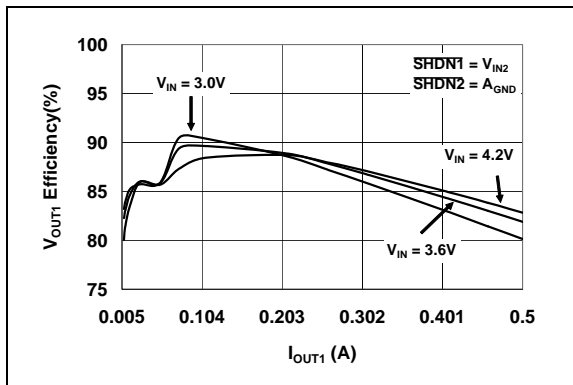
**FIGURE 2-3:**  $I_Q$  LDO Current vs. Ambient Temperature.



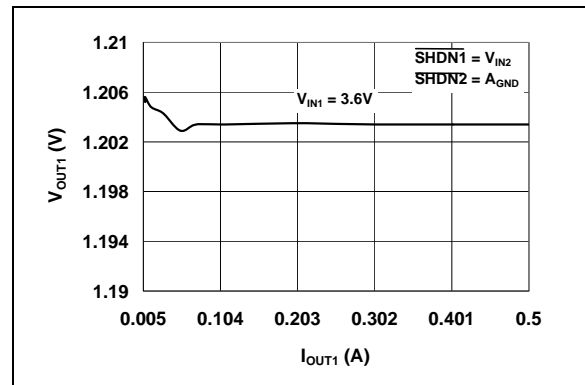
**FIGURE 2-6:**  $V_{OUT1}$  Output Efficiency vs. Input Voltage ( $V_{OUT1} = 1.8\text{V}$ ).



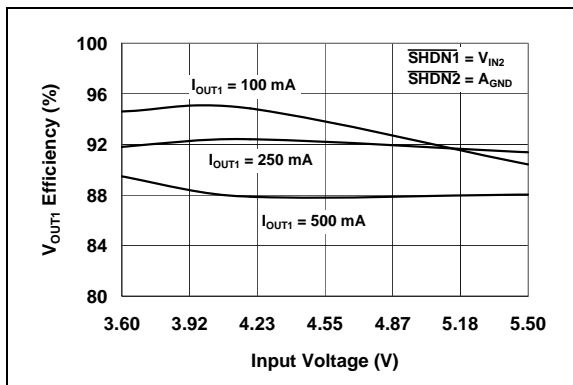
**Note:** Unless otherwise indicated,  $V_{IN1} = V_{IN2} = \overline{SHDN1,2} = 3.6V$ ,  $C_{OUT1} = C_{IN} = 4.7 \mu F$ ,  $C_{OUT2} = 1 \mu F$ ,  $L = 4.7 \mu H$ ,  $V_{OUT1} (ADJ) = 1.8V$ ,  $T_A = +25^\circ C$ . **Boldface** specifications apply over the  $T_A$  range of  $-40^\circ C$  to  $+85^\circ C$ .  $T_A = +25^\circ C$ . Adjustable or fixed-output voltage options can be used to generate the Typical Performance Characteristics.



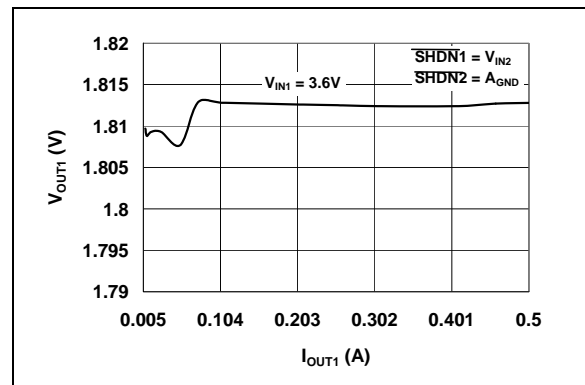
**FIGURE 2-7:**  $V_{OUT1}$  Output Efficiency vs.  $I_{OUT1}$  ( $V_{OUT1} = 1.8V$ ).



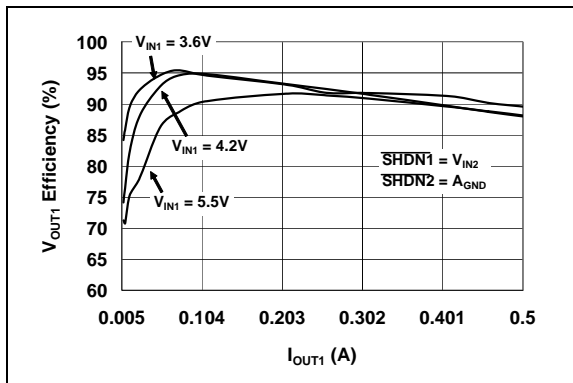
**FIGURE 2-10:**  $V_{OUT1}$  vs.  $I_{OUT1}$  ( $V_{OUT1} = 1.2V$ ).



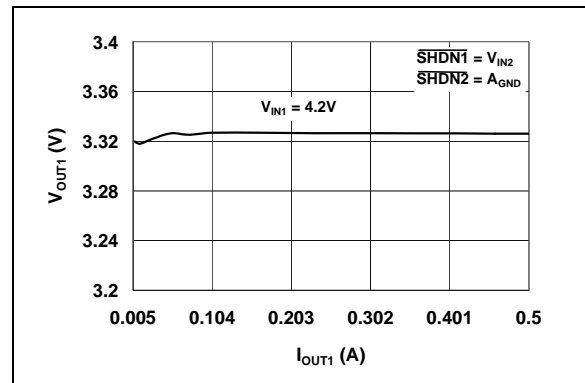
**FIGURE 2-8:**  $V_{OUT1}$  Output Efficiency vs. Input Voltage ( $V_{OUT1} = 3.3V$ ).



**FIGURE 2-11:**  $V_{OUT1}$  vs.  $I_{OUT1}$  ( $V_{OUT1} = 1.8V$ ).



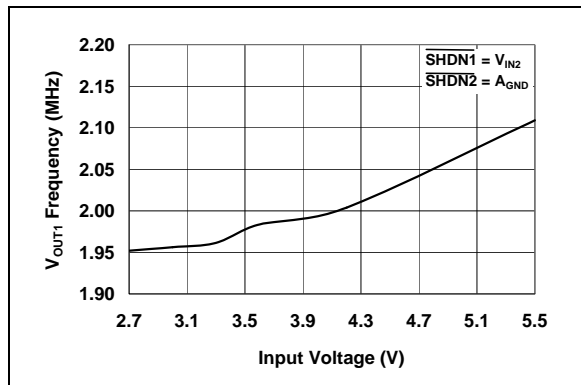
**FIGURE 2-9:**  $V_{OUT1}$  Output Efficiency vs.  $I_{OUT1}$  ( $V_{OUT1} = 3.3V$ ).



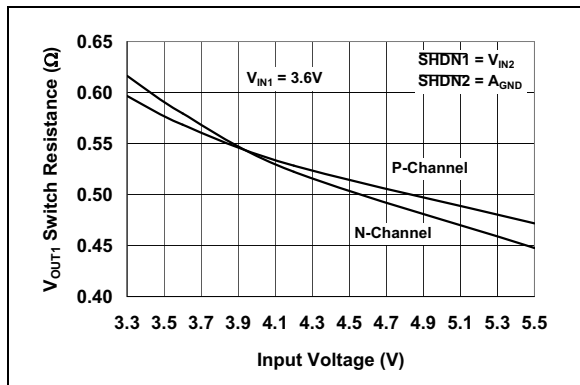
**FIGURE 2-12:**  $V_{OUT1}$  vs.  $I_{OUT1}$  ( $V_{OUT1} = 3.3V$ ).

# TC1313

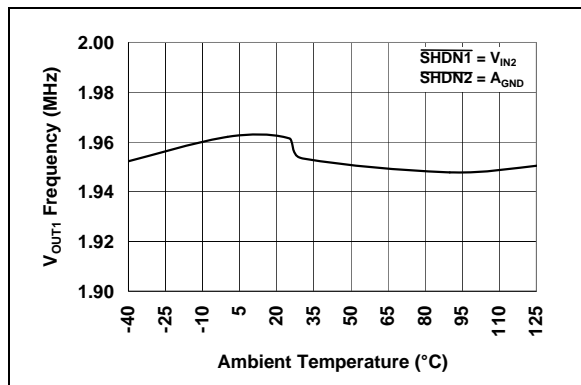
**Note:** Unless otherwise indicated,  $V_{IN1} = V_{IN2} = \overline{SHDN1,2} = 3.6V$ ,  $C_{OUT1} = C_{IN} = 4.7 \mu F$ ,  $C_{OUT2} = 1 \mu F$ ,  $L = 4.7 \mu H$ ,  $V_{OUT1} (ADJ) = 1.8V$ ,  $T_A = +25^\circ C$ . **Boldface** specifications apply over the  $T_A$  range of  $-40^\circ C$  to  $+85^\circ C$ .  $T_A = +25^\circ C$ . Adjustable or fixed-output voltage options can be used to generate the Typical Performance Characteristics.



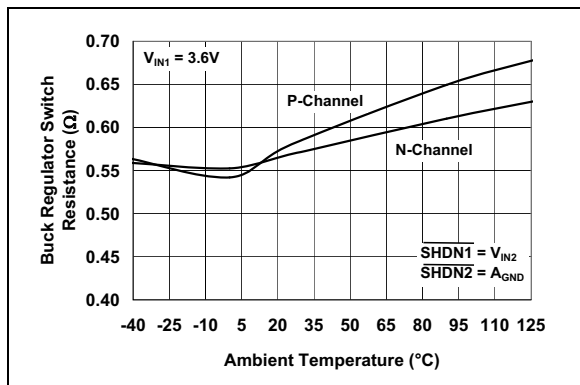
**FIGURE 2-13:**  $V_{OUT1}$  Switching Frequency vs. Input Voltage.



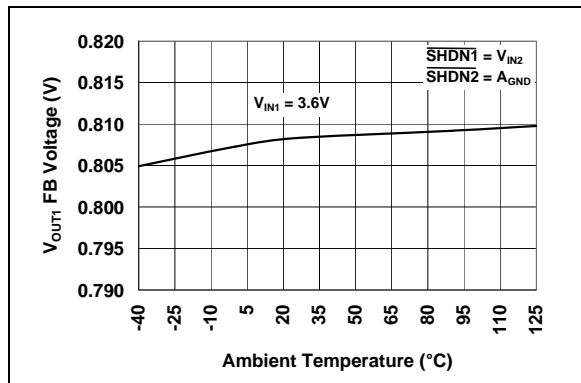
**FIGURE 2-16:**  $V_{OUT1}$  Switch Resistance vs. Input Voltage.



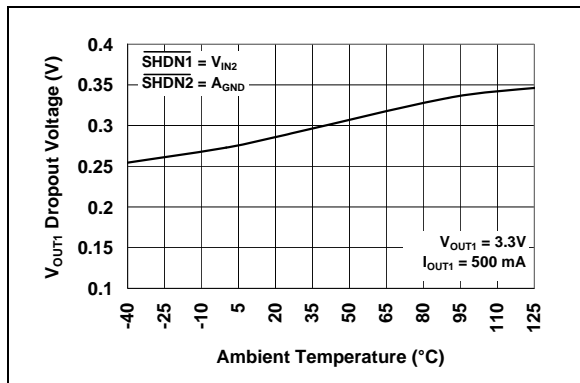
**FIGURE 2-14:**  $V_{OUT1}$  Switching Frequency vs. Ambient Temperature.



**FIGURE 2-17:**  $V_{OUT1}$  Switch Resistance vs. Ambient Temperature.

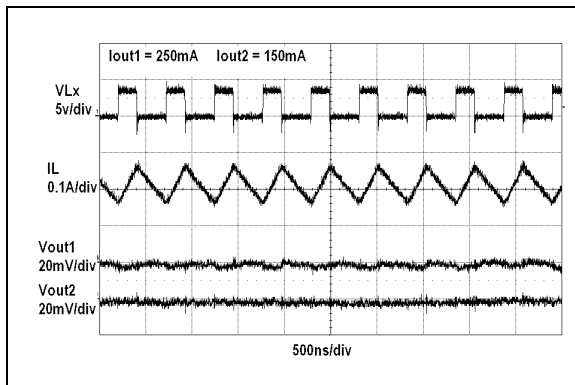


**FIGURE 2-15:**  $V_{OUT1}$  Adjustable Feedback Voltage vs. Ambient Temperature.

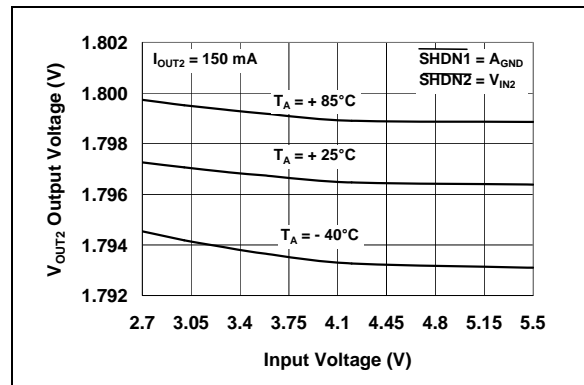


**FIGURE 2-18:**  $V_{OUT1}$  Dropout Voltage vs. Ambient Temperature.

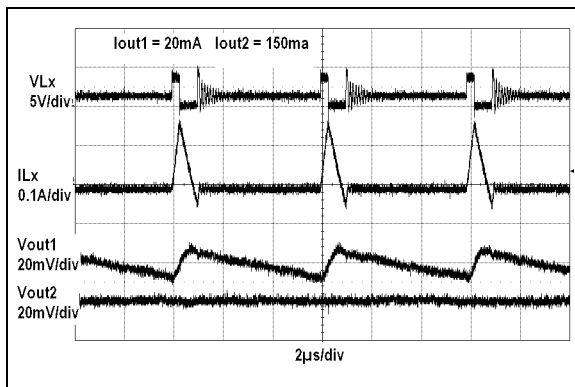
**Note:** Unless otherwise indicated,  $V_{IN1} = V_{IN2} = \overline{\text{SHDN1,2}} = 3.6\text{V}$ ,  $C_{OUT1} = C_{IN} = 4.7\ \mu\text{F}$ ,  $C_{OUT2} = 1\ \mu\text{F}$ ,  $L = 4.7\ \mu\text{H}$ ,  $V_{OUT1}$  (ADJ) = 1.8V,  $T_A = +25^\circ\text{C}$ . **Boldface** specifications apply over the  $T_A$  range of  $-40^\circ\text{C}$  to  $+85^\circ\text{C}$ .  $T_A = +25^\circ\text{C}$ . Adjustable or fixed-output voltage options can be used to generate the Typical Performance Characteristics.



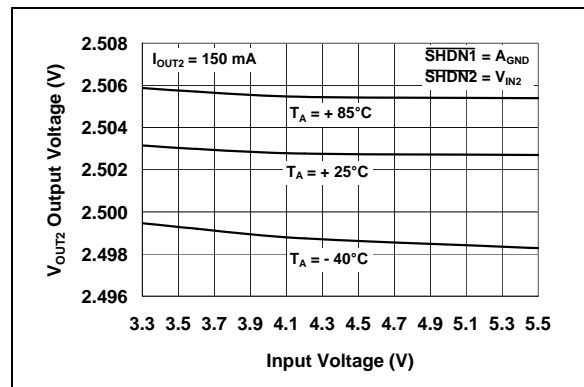
**FIGURE 2-19:**  $V_{OUT1}$  and  $V_{OUT2}$  Heavy Load Switching Waveforms vs. Time.



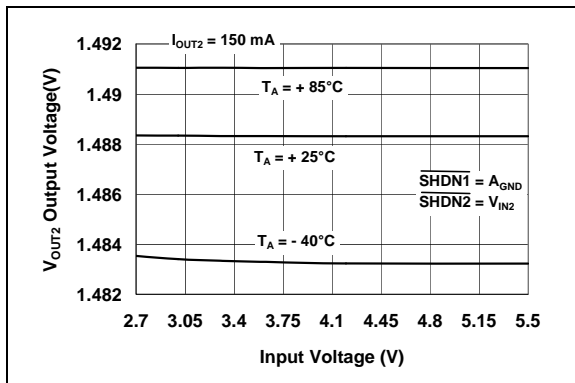
**FIGURE 2-22:**  $V_{OUT2}$  Output Voltage vs. Input Voltage ( $V_{OUT2} = 1.8\text{V}$ ).



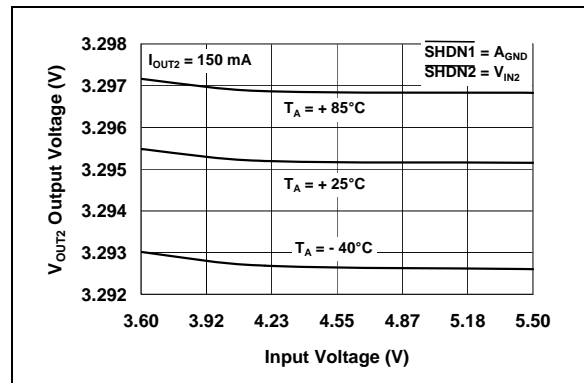
**FIGURE 2-20:**  $V_{OUT1}$  and  $V_{OUT2}$  Light Load Switching Waveforms vs. Time.



**FIGURE 2-23:**  $V_{OUT2}$  Output Voltage vs. Input Voltage ( $V_{OUT2} = 2.5\text{V}$ ).



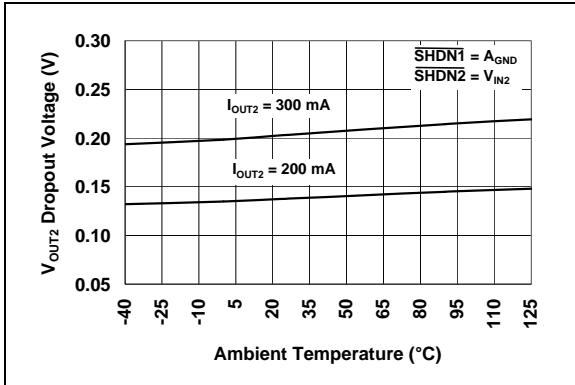
**FIGURE 2-21:**  $V_{OUT2}$  Output Voltage vs. Input Voltage ( $V_{OUT2} = 1.5\text{V}$ ).



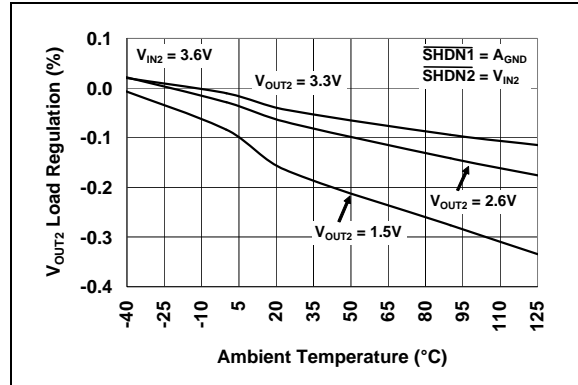
**FIGURE 2-24:**  $V_{OUT2}$  Output Voltage vs. Input Voltage ( $V_{OUT2} = 3.3\text{V}$ ).

# TC1313

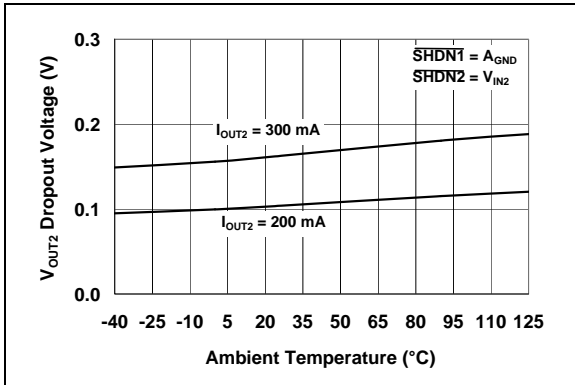
**Note:** Unless otherwise indicated,  $V_{IN1} = V_{IN2} = \overline{\text{SHDN1,2}} = 3.6\text{V}$ ,  $C_{OUT1} = C_{IN} = 4.7\ \mu\text{F}$ ,  $C_{OUT2} = 1\ \mu\text{F}$ ,  $L = 4.7\ \mu\text{H}$ ,  $V_{OUT1}$  (ADJ) = 1.8V,  $T_A = +25^\circ\text{C}$ . **Boldface** specifications apply over the  $T_A$  range of  $-40^\circ\text{C}$  to  $+85^\circ\text{C}$ .  $T_A = +25^\circ\text{C}$ . Adjustable or fixed-output voltage options can be used to generate the Typical Performance Characteristics.



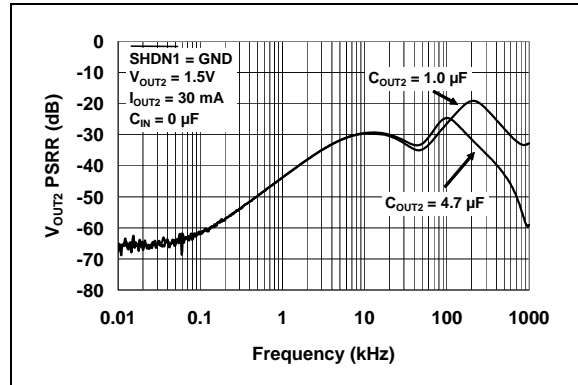
**FIGURE 2-25:**  $V_{OUT2}$  Dropout Voltage vs. Ambient Temperature ( $V_{OUT2} = 2.5\text{V}$ ).



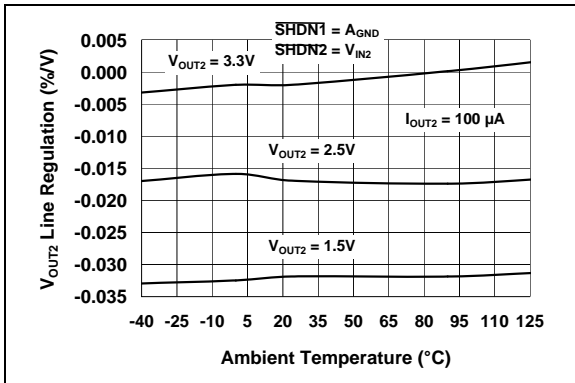
**FIGURE 2-28:**  $V_{OUT2}$  Load Regulation vs. Ambient Temperature.



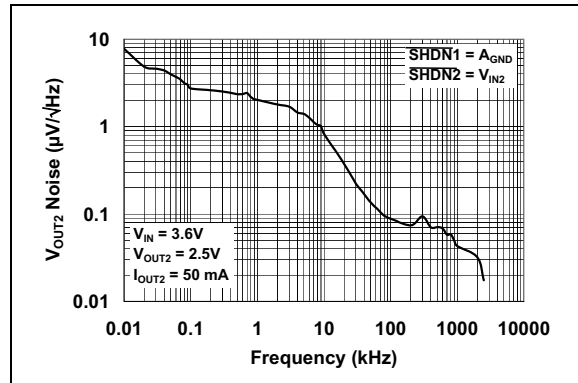
**FIGURE 2-26:**  $V_{OUT2}$  Dropout Voltage vs. Ambient Temperature ( $V_{OUT2} = 3.3\text{V}$ ).



**FIGURE 2-29:**  $V_{OUT2}$  Power Supply Ripple Rejection vs. Frequency.

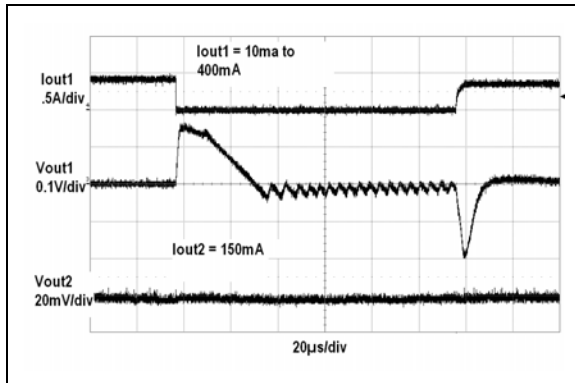


**FIGURE 2-27:**  $V_{OUT2}$  Line Regulation vs. Ambient Temperature.

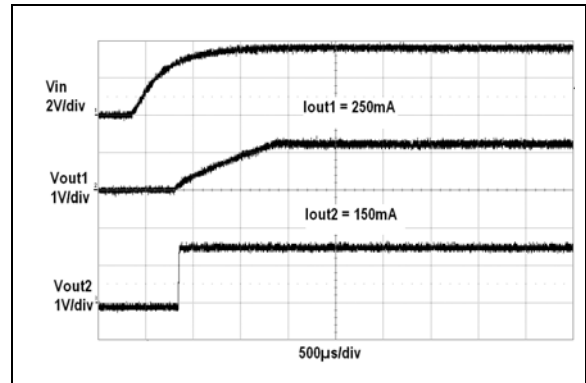


**FIGURE 2-30:**  $V_{OUT2}$  Noise vs. Frequency.

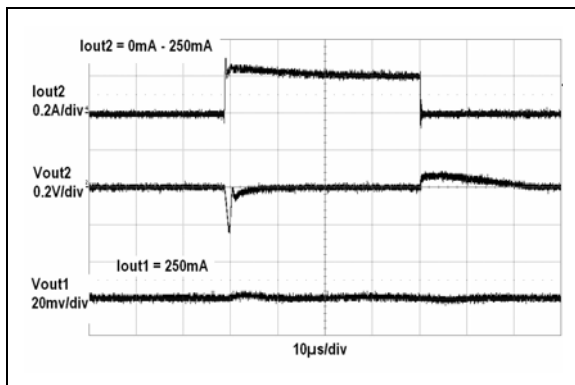
**Note:** Unless otherwise indicated,  $V_{IN1} = V_{IN2} = \overline{\text{SHDN1,2}} = 3.6\text{V}$ ,  $C_{OUT1} = C_{IN} = 4.7\ \mu\text{F}$ ,  $C_{OUT2} = 1\ \mu\text{F}$ ,  $L = 4.7\ \mu\text{H}$ ,  $V_{OUT1}(\text{ADJ}) = 1.8\text{V}$ ,  $T_A = +25^\circ\text{C}$ . **Boldface** specifications apply over the  $T_A$  range of  $-40^\circ\text{C}$  to  $+85^\circ\text{C}$ .  $T_A = +25^\circ\text{C}$ . Adjustable or fixed-output voltage options can be used to generate the Typical Performance Characteristics.



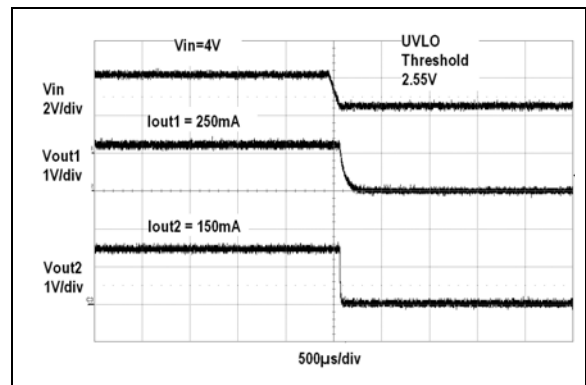
**FIGURE 2-31:**  $V_{OUT1}$  Load Step Response vs. Time.



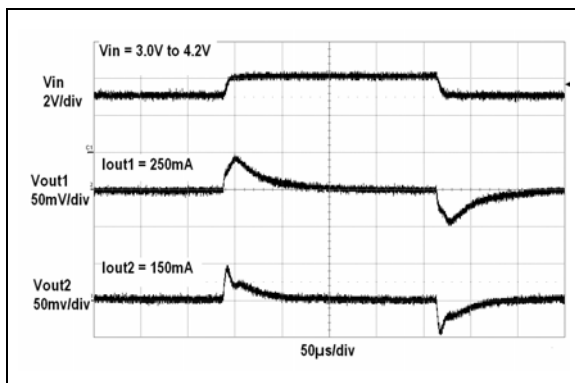
**FIGURE 2-34:**  $V_{OUT1}$  and  $V_{OUT2}$  Startup Waveforms.



**FIGURE 2-32:**  $V_{OUT2}$  Load Step Response vs. Time.



**FIGURE 2-35:**  $V_{OUT1}$  and  $V_{OUT2}$  Shutdown Waveforms.



**FIGURE 2-33:**  $V_{OUT1}$  and  $V_{OUT2}$  Line Step Response vs. Time.

# TC1313

---

NOTES:

## 3.0 PIN DESCRIPTIONS

The descriptions of the pins are listed in [Table 3-1](#).

**TABLE 3-1: PIN FUNCTION TABLE**

Pin	DFN	MSOP	Function
1	SHDN2	SHDN2	Active Low Shutdown Input for LDO Output Pin
2	V <sub>IN2</sub>	V <sub>IN2</sub>	Analog Input Supply Voltage Pin
3	V <sub>OUT2</sub>	V <sub>OUT2</sub>	LDO Output Voltage Pin
4	NC	NC	No Connect
5	A <sub>GND</sub>	A <sub>GND</sub>	Analog Ground Pin
6	V <sub>FB</sub> / V <sub>OUT1</sub>	V <sub>FB</sub> / V <sub>OUT1</sub>	Buck Feedback Voltage (Adjustable Version)/Buck Output Voltage (Fixed Version) Pin
7	SHDN1	SHDN1	Active Low Shutdown Input for Buck Regulator Output Pin
8	V <sub>IN1</sub>	V <sub>IN1</sub>	Buck Regulator Input Voltage Pin
9	L <sub>X</sub>	L <sub>X</sub>	Buck Inductor Output Pin
10	P <sub>GND</sub>	P <sub>GND</sub>	Power Ground Pin
11	EP	—	Exposed Pad. It is a thermal path to remove heat from the device. Electrically, this pad is at ground potential and should be connected to A <sub>GND</sub> .

### 3.1 LDO Shutdown Input Pin (SHDN2)

SHDN2 is a logic-level input used to turn the LDO regulator on and off. A logic-high (> 45% of V<sub>IN</sub>) will enable the regulator output. A logic-low (< 15% of V<sub>IN</sub>) will ensure that the output is turned off.

### 3.2 LDO Input Voltage Pin (V<sub>IN2</sub>)

V<sub>IN2</sub> is a LDO power-input supply pin. Connect variable-input voltage source to V<sub>IN2</sub>. Connect V<sub>IN1</sub> and V<sub>IN2</sub> together with board traces as short as possible. V<sub>IN2</sub> provides the input voltage for the LDO regulator. An additional capacitor can be added to lower the LDO regulator input ripple voltage.

### 3.3 LDO Output Voltage Pin (V<sub>OUT2</sub>)

V<sub>OUT2</sub> is a regulated LDO output voltage pin. Connect a 1 μF or larger capacitor to V<sub>OUT2</sub> and A<sub>GND</sub> for proper operation.

### 3.4 No Connect Pin (NC)

No connection.

### 3.5 Analog Ground Pin (A<sub>GND</sub>)

A<sub>GND</sub> is the analog ground connection. Tie A<sub>GND</sub> to the analog portion of the ground plane (A<sub>GND</sub>). See the physical layout information in [Section 5.0 “Application Circuits/Issues”](#) for grounding recommendations.

### 3.6 Buck Regulator Output Sense Pin (V<sub>FB</sub>/V<sub>OUT1</sub>)

For V<sub>OUT1</sub> adjustable-output voltage options, connect the center of the output voltage divider to the V<sub>FB</sub> pin. For fixed-output voltage options, connect the output of the buck regulator to this pin (V<sub>OUT1</sub>).

### 3.7 Buck Regulator Shutdown Input Pin (SHDN1)

SHDN1 is a logic-level input used to turn the buck regulator on and off. A logic-high (> 45% of V<sub>IN</sub>) will enable the regulator output. A logic-low (< 15% of V<sub>IN</sub>) will ensure that the output is turned off.

### 3.8 Buck Regulator Input Voltage Pin (V<sub>IN1</sub>)

V<sub>IN1</sub> is the buck regulator power-input supply pin. Connect a variable-input voltage source to V<sub>IN1</sub>. Connect V<sub>IN1</sub> and V<sub>IN2</sub> together with board traces as short as possible.

### 3.9 Buck Inductor Output Pin (L<sub>X</sub>)

Connect L<sub>X</sub> directly to the buck inductor. This pin carries large signal-level current; all connections should be made as short as possible.

### 3.10 Power Ground Pin (P<sub>GND</sub>)

Connect all large-signal level ground returns to P<sub>GND</sub>. These large-signal level ground traces should have a small loop area and length to prevent coupling of switching noise to sensitive traces. Please see the physical layout information supplied in [Section 5.0 “Application Circuits/Issues”](#) for grounding recommendations.

### 3.11 Exposed Pad (EP)

For the DFN package, connect the EP to A<sub>GND</sub> with vias into the A<sub>GND</sub> plane.

# TC1313

---

NOTES:



## 4.0 DETAILED DESCRIPTION

### 4.1 Device Overview

The TC1313 combines a 500 mA synchronous buck regulator with a 300 mA LDO. This unique combination provides a small, low-cost solution for applications that require two or more voltage rails. The buck regulator can deliver high-output current over a wide range of input-to-output voltage ratios while maintaining high efficiency. This is typically used for the lower-voltage, higher-current processor core. The LDO is a minimal parts-count solution (single-output capacitor), providing a regulated voltage for an auxiliary rail. The typical LDO dropout voltage (137 mV @ 200 mA) allows the use of very low input-to-output LDO differential voltages, minimizing the power loss internal to the LDO pass transistor. Integrated features include independent shutdown inputs, UVLO, overcurrent and overtemperature shutdown.

### 4.2 Synchronous Buck Regulator

The synchronous buck regulator is capable of supplying a 500 mA continuous output current over a wide range of input and output voltages. The output voltage range is from 0.8V (min) to 4.5V (max). The regulator operates in three different modes and automatically selects the most efficient mode of operation. During heavy load conditions, the TC1313 buck converter operates at a high, fixed frequency (2.0 MHz) using current mode control. This minimizes output ripple and noise (less than 8 mV peak-to-peak ripple) while maintaining high efficiency (typically > 90%). For standby or light-load applications, the buck regulator will automatically switch to a power-saving Pulse Frequency Modulation (PFM) mode. This minimizes the quiescent current draw on the battery while keeping the buck output voltage in regulation. The typical buck PFM mode current is 38  $\mu$ A. The buck regulator is capable of operating at 100% duty cycle, minimizing the voltage drop from input to output for wide-input, battery-powered applications. For fixed-output voltage applications, the feedback divider and control loop compensation components are integrated, eliminating the need for external components. The buck regulator output is protected against overcurrent, short circuit and overtemperature. While shut down, the synchronous buck N-channel and P-channel switches are off, so the L<sub>X</sub> pin is in a high-impedance state (this allows for connecting a source on the output of the buck regulator as long as its voltage does not exceed the input voltage).

#### 4.2.1 FIXED-FREQUENCY PWM MODE

While operating in Pulse Width Modulation (PWM) mode, the TC1313 buck regulator switches at a fixed 2.0 MHz frequency. The PWM mode is suited for higher load current operation, maintaining low output noise and high conversion efficiency. PFM to PWM mode transition is initiated for any of the following conditions.

- Continuous inductor current is sensed
- Inductor peak current exceeds 100 mA
- The buck regulator output voltage has dropped out of regulation (step load has occurred)

The typical PFM-to-PWM threshold is 80 mA.

#### 4.2.2 PFM MODE

PFM mode is entered when the output load on the buck regulator is very light. Once detected, the converter enters the PFM mode automatically and begins to skip pulses to minimize unnecessary quiescent current draw by reducing the number of switching cycles per second. The typical quiescent current for the switching regulator is less than 38  $\mu$ A. The transition from PWM to PFM mode occurs when discontinuous inductor current is sensed, or the peak inductor current is less than 60 mA (typ.). The typical PWM to PFM mode threshold is 30 mA. For low input-to-output differential voltages, the PWM to PFM mode threshold can be low due to the lack of ripple current. It is recommended that  $V_{IN1}$  be one volt greater than  $V_{OUT1}$  for PWM to PFM transitions.

### 4.3 Low-Dropout Regulator (LDO)

The LDO output is a 300 mA low-dropout linear regulator that provides a regulated output voltage with a single 1  $\mu$ F external capacitor. The output voltage is available in fixed options only, ranging from 1.5V to 3.3V. The LDO is stable using ceramic output capacitors that inherently provide lower output noise and reduce the size and cost of the regulator solution. The quiescent current consumed by the LDO output is typically less than 43.7  $\mu$ A, with a typical dropout voltage of 137 mV at 200 mA. The LDO output is protected against overcurrent and overtemperature. While operating in Dropout mode, the LDO quiescent current will increase, minimizing the necessary voltage differential needed for the LDO output to maintain regulation. The LDO output is protected against overcurrent and overtemperature.

### 4.4 Soft Start

Both outputs of the TC1313 are controlled during startup. Less than 1% of  $V_{OUT1}$  or  $V_{OUT2}$  overshoot is observed during start-up from  $V_{IN}$  rising above the UVLO voltage; or SHDN1 or SHDN2 being enabled.

## 4.5 Overtemperature Protection

The TC1313 has an integrated overtemperature protection circuit that monitors the device junction temperature and shuts the device off if the junction temperature exceeds the typical 165°C threshold. If the overtemperature threshold is reached, the soft start is reset so that, once the junction temperature cools to approximately 155°C, the device will automatically restart.

## 5.0 APPLICATION CIRCUITS/ISSUES

### 5.1 Typical Applications

The TC1313 500 mA buck regulator + 300 mA LDO operates over a wide input-voltage range (2.7V to 5.5V) and is ideal for single-cell Li-Ion battery-powered applications, USB-powered applications, three-cell NiMH or NiCd applications and 3V to 5V regulated input applications. The 10-pin MSOP and 3x3 DFN packages provide a small footprint with minimal external components.

### 5.2 Fixed-Output Application

A typical  $V_{OUT1}$  fixed-output voltage application is shown in “**Typical Application Circuits**”. A 4.7  $\mu\text{F}$   $V_{IN1}$  ceramic input capacitor, 4.7  $\mu\text{F}$   $V_{OUT1}$  ceramic capacitor, 1.0  $\mu\text{F}$  ceramic  $V_{OUT2}$  capacitor and 4.7  $\mu\text{H}$  inductor make up the entire external component solution for this dual-output application. No external dividers or compensation components are necessary. For this application, the input-voltage range is 2.7V to 4.2V,  $V_{OUT1} = 1.5\text{V}$  at 500 mA, while  $V_{OUT2} = 2.5\text{V}$  at 300 mA.

### 5.3 Adjustable-Output Application

A typical  $V_{OUT1}$  adjustable-output application is also shown in “**Typical Application Circuits**”. For this application, the buck regulator output voltage is adjustable by using two external resistors as a voltage divider. For adjustable-output voltages, it is recommended that the top resistor divider value be 200 k $\Omega$ . The bottom resistor divider can be calculated using the following formula:

**EQUATION 5-1:**

$$R_{BOT} = R_{TOP} \times \left( \frac{V_{FB}}{V_{OUT1} - V_{FB}} \right)$$

**Example:**

$$\begin{aligned} R_{TOP} &= 200 \text{ k}\Omega \\ V_{OUT1} &= 2.1\text{V} \\ V_{FB} &= 0.8\text{V} \\ R_{BOT} &= 200 \text{ k}\Omega \times (0.8\text{V}/(2.1\text{V} - 0.8\text{V})) \\ R_{BOT} &= 123 \text{ k}\Omega \text{ (Standard Value = 121 k}\Omega) \end{aligned}$$

For adjustable output applications, an additional R-C compensation is necessary for the buck regulator control loop stability. Recommended values are:

$$\begin{aligned} R_{COMP} &= 4.99 \text{ k}\Omega \\ C_{COMP} &= 33 \text{ pF} \end{aligned}$$

An additional  $V_{IN2}$  capacitor can be added to reduce high-frequency noise on the LDO input-voltage pin ( $V_{IN2}$ ). This additional capacitor (1  $\mu\text{F}$ ) is not necessary for typical applications.

### 5.4 Input and Output Capacitor Selection

As with all buck-derived dc-dc switching regulators, the input current is pulled from the source in pulses. This places a burden on the TC1313 input filter capacitor. In most applications, a minimum of 4.7  $\mu\text{F}$  is recommended on  $V_{IN1}$  (buck regulator input-voltage pin). In applications that have high source impedance, or have long leads (10 inches) connecting to the input source, additional capacitance should be used. The capacitor type can be electrolytic (aluminum, tantalum, POSCAP, OSCON) or ceramic. For most portable electronic applications, ceramic capacitors are preferred due to their small size and low cost.

For applications that require very low noise on the LDO output, an additional capacitor (typically 1  $\mu\text{F}$ ) can be added to the  $V_{IN2}$  pin (LDO input voltage pin).

Low ESR electrolytic or ceramic can be used for the buck regulator output capacitor. Again, ceramic is recommended because of its physical attributes and cost. For most applications, a 4.7  $\mu\text{F}$  is recommended. Refer to [Table 5-1](#) for recommended values. Larger capacitors (up to 22  $\mu\text{F}$ ) can be used. There are some advantages in load step performance when using larger value capacitors. Ceramic materials, X7R and X5R, have low temperature coefficients and are well within the acceptable ESR range required.

**TABLE 5-1: TC1313 RECOMMENDED CAPACITOR VALUES**

	C ( $V_{IN1}$ )	C ( $V_{IN2}$ )	C <sub>OUT1</sub>	C <sub>OUT2</sub>
Min	4.7 $\mu\text{F}$	none	4.7 $\mu\text{F}$	1 $\mu\text{F}$
Max	none	none	22 $\mu\text{F}$	10 $\mu\text{F}$

## 5.5 Inductor Selection

For most applications, a 4.7  $\mu\text{H}$  inductor is recommended to minimize noise. There are many different magnetic core materials and package options to select from. That decision is based on size, cost and acceptable radiated energy levels. Toroid and shielded ferrite pot cores will have low radiated energy but tend to be larger and more expensive. With a typical 2.0 MHz switching frequency, the inductor ripple current can be calculated based on the following formulas.

### EQUATION 5-2:

$$\text{DutyCycle} = \frac{V_{OUT}}{V_{IN}}$$

Duty cycle represents the percentage of switch-on time.

### EQUATION 5-3:

$$T_{ON} = \text{DutyCycle} \times \frac{1}{F_{SW}}$$

Where:

$$F_{SW} = \text{Switching Frequency}$$

The inductor ac ripple current can be calculated using the following relationship:

### EQUATION 5-4:

$$V_L = L \times \frac{\Delta I_L}{\Delta t}$$

Where:

$$\begin{aligned} V_L &= \text{voltage across the inductor} \\ &\quad (V_{IN} - V_{OUT}) \\ \Delta t &= \text{on-time of P-channel MOSFET} \end{aligned}$$

Solving for  $\Delta I_L$  = yields:

### EQUATION 5-5:

$$\Delta I_L = \frac{V_L}{L} \times \Delta t$$

When considering inductor ratings, the maximum DC current rating of the inductor should be at least equal to the maximum buck regulator load current ( $I_{OUT1}$ ), plus one half of the peak-to-peak inductor ripple current ( $1/2 * \Delta I_L$ ). The inductor DC resistance can add to the buck converter  $I^2R$  losses. A rating of less than 200 m $\Omega$  is recommended. Overall efficiency will be improved by using lower DC resistance inductors.

TABLE 5-2: TC1313 RECOMMENDED INDUCTOR VALUES

Part Number	Value ( $\mu\text{H}$ )	DCR $\Omega$ (max)	MAX $I_{DC}$ (A)	Size WxLxH (mm)
<b>Coiltronics®</b>				
SD10	2.2	0.091	1.35	5.2, 5.2, 1.0 max.
SD10	3.3	0.108	1.24	5.2, 5.2, 1.0 max.
SD10	4.7	0.154	1.04	5.2, 5.2, 1.0 max.
<b>Coiltronics</b>				
SD12	2.2	0.075	1.80	5.2, 5.2, 1.2 max.
SD12	3.3	0.104	1.42	5.2, 5.2, 1.2 max.
SD12	4.7	0.118	1.29	5.2, 5.2, 1.2 max.
<b>Sumida Corporation®</b>				
CMD411	2.2	0.116	0.950	4.4, 5.8, 1.2 max.
CMD411	3.3	0.174	0.770	4.4, 5.8, 1.2 max.
CMD411	4.7	0.216	0.750	4.4, 5.8, 1.2 max.
<b>Coilcraft®</b>				
1008PS	4.7	0.35	1.0	3.8, 3.8, 2.74 max.
1812PS	4.7	0.11	1.15	5.9, 5.0, 3.81 max.

## 5.6 Thermal Calculations

### 5.6.1 BUCK REGULATOR OUTPUT ( $V_{OUT1}$ )

The TC1313 is available in two different 10-pin packages (MSOP and 3x3 DFN). By calculating the power dissipation and applying the package thermal resistance, ( $\theta_{JA}$ ), the junction temperature is estimated. The maximum continuous junction temperature rating for the TC1313 is +125°C.

To quickly estimate the internal power dissipation for the switching buck regulator, an empirical calculation using measured efficiency can be used. Given the measured efficiency (Section 2.0 "Typical Performance Curves"), the internal power dissipation is estimated below.

### EQUATION 5-6:

$$\left( \frac{V_{OUT1} \times I_{OUT1}}{\text{Efficiency}} \right) - (V_{OUT1} \times I_{OUT1}) = P_{Dissipation}$$

The first term is equal to the input power (definition of efficiency,  $P_{OUT}/P_{IN} = \text{Efficiency}$ ). The second term is equal to the delivered power. The difference is internal power dissipation. This estimate assumes that most of the power lost is internal to the TC1313. There is some percentage of power lost in the buck inductor, with very little loss in the input and output capacitors.

For example, for a 3.6V input, 1.8V output with a load of 400 mA, the efficiency taken from Figure 2-7 is approximately 84%. The internal power dissipation is approximately 137 mW.

## 5.6.2 LDO OUTPUT ( $V_{OUT2}$ )

The internal power dissipation within the TC1313 LDO is a function of input voltage, output voltage and output current. The following equation can be used to calculate the internal power dissipation for the LDO.

### EQUATION 5-7:

$$P_{LDO} = (V_{IN(MAX)} - V_{OUT2(MIN)}) \times I_{OUT2(MAX)}$$

Where:

$P_{LDO}$  = LDO Pass device internal power dissipation

$V_{IN(MAX)}$  = Maximum input voltage

$V_{OUT(MIN)}$  = LDO minimum output voltage

The maximum power dissipation capability for a package can be calculated given the junction-to-ambient thermal resistance and the maximum ambient temperature for the application. The following equation can be used to determine the package's maximum internal power dissipation.

## 5.6.3 LDO POWER DISSIPATION EXAMPLE

### Input Voltage

$$V_{IN} = 5V \pm 10\%$$

### LDO Output Voltage and Current

$$V_{OUT} = 3.3V$$

$$I_{OUT} = 300 \text{ mA}$$

### Internal Power Dissipation

$$P_{LDO(MAX)} = (V_{IN(MAX)} - V_{OUT2(MIN)}) \times I_{OUT2(MAX)}$$

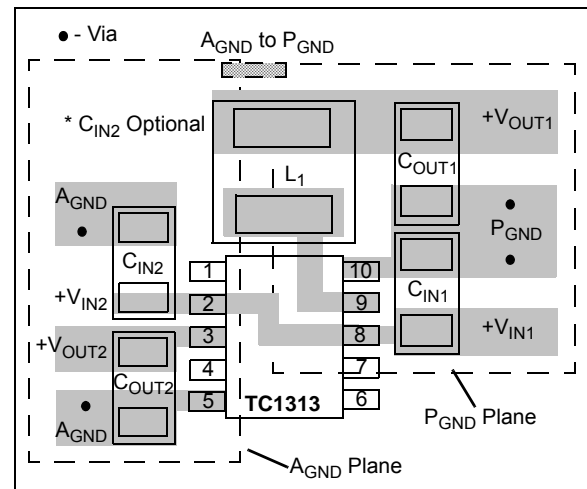
$$P_{LDO} = (5.5V) - (0.975 \times 3.3V) \\ \times 300 \text{ mA}$$

$$P_{LDO} = 684.8 \text{ mW}$$

## 5.7 PCB Layout Information

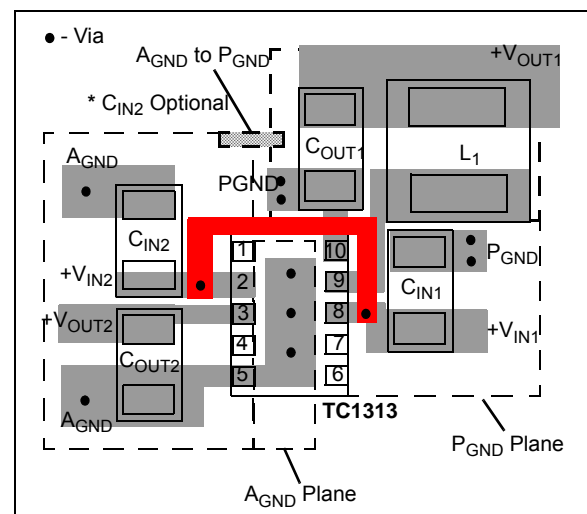
Some basic design guidelines should be used when physically placing the TC1313 on a Printed Circuit Board (PCB). The TC1313 has two ground pins, identified as  $A_{GND}$  (analog ground) and  $P_{GND}$  (power ground). By separating grounds, it is possible to minimize the switching frequency noise on the LDO output. The first priority, while placing external components on the board, is the input capacitor ( $C_{IN1}$ ). Wiring should be short and wide; the input current for the TC1313 can be as high as 800 mA. The next priority would be the buck regulator output capacitor ( $C_{OUT1}$ ) and inductor ( $L_1$ ). All three of these components are placed near their respective pins to

minimize trace length. The  $C_{IN1}$  and  $C_{OUT1}$  capacitor returns are connected closely together at the  $P_{GND}$  plane. The LDO optional input capacitor ( $C_{IN2}$ ) and LDO output capacitor  $C_{OUT2}$  are returned to the  $A_{GND}$  plane. The analog ground plane and power ground plane are connected at one point (shown near  $L_1$ ). All other signals ( $\overline{SHDN1}$ ,  $\overline{SHDN2}$ , feedback in the adjustable output case) should be referenced to  $A_{GND}$  and have the  $A_{GND}$  plane underneath them.



**FIGURE 5-1:** Component Placement, Fixed-Output 10-Pin MSOP.

There will be some difference in layout for the 10-pin DFN package due to the thermal pad. A typical fixed-output DFN layout is shown below. For the DFN layout, the  $V_{IN1}$  to  $V_{IN2}$  connection is routed on the bottom of the board around the TC1313 thermal pad.



**FIGURE 5-2:** Component Placement, Fixed-Output 10-Pin DFN.

## 5.8 Design Example

$$\begin{aligned}V_{OUT1} &= 2.0V @ 500 \text{ mA} \\V_{OUT2} &= 3.3V @ 300 \text{ mA} \\V_{IN} &= 5V \pm 10\% \\L &= 4.7 \mu\text{H}\end{aligned}$$

Calculate PWM mode inductor ripple current

Nominal Duty

$$\text{Cycle} = 2.0V/5.0V = 40\%$$

P-channel

$$\text{Switch-on time} = 0.40 \times 1/(2 \text{ MHz}) = 200 \text{ ns}$$

$$V_L = (V_{IN} - V_{OUT1}) = 3V$$

$$\Delta I_L = (V_L/L) \times T_{ON} = 128 \text{ mA}$$

Peak inductor current:

$$I_{L(PK)} = I_{OUT1} + 1/2 \Delta I_L = 564 \text{ mA}$$

Switcher power loss:

Use efficiency estimate for 1.8V from [Figure 2-7](#)

$$\text{Efficiency} = 84\%, P_{DISS1} = 190 \text{ mW}$$

Resistor Divider:

$$R_{TOP} = 200 \text{ k}\Omega$$

$$R_{BOT} = 133 \text{ k}\Omega$$

LDO Output:

$$\begin{aligned}P_{DISS2} &= (V_{IN(MAX)} - \\ &\quad V_{OUT2(MIN)}) \times I_{OUT2(MAX)} \\P_{DISS2} &= (5.5V - (0.975) \times 3.3V) \times 300 \text{ mA} \\P_{DISS2} &= 684.8 \text{ mW}\end{aligned}$$

Total

$$\text{Dissipation} = 190 \text{ mW} + 685 \text{ mW} = 875 \text{ mW}$$

Junction Temp Rise and Maximum Ambient  
Operating Temperature Calculations

---

**10-Pin MSOP** (4-Layer Board with internal Planes)

$$R_{\theta JA} = 113^\circ \text{ C/Watt}$$

Junction Temp.

$$\text{Rise} = 875 \text{ mW} \times 113^\circ \text{ C/Watt} = 98.9^\circ \text{C}$$

Max. Ambient

$$\text{Temperature} = 125^\circ \text{C} - 98.9^\circ \text{C}$$

Max. Ambient

$$\text{Temperature} = 26.1^\circ \text{C}$$

---

**10-Pin DFN**

$$R_{\theta JA} = 41^\circ \text{ C/Watt (4-Layer Board with internal planes and 2 vias)}$$

Junction Temp.

$$\text{Rise} = 875 \text{ mW} \times 41^\circ \text{ C/Watt} = 35.9^\circ \text{C}$$

Max. Ambient

$$\text{Temperature} = 125^\circ \text{C} - 35.9^\circ \text{C}$$

Max. Ambient

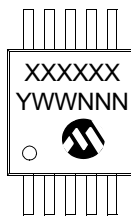
$$\text{Temperature} = 89.1^\circ \text{C}$$

This is above the +85°C max. ambient temperature.

## 6.0 PACKAGING INFORMATION

### 6.1 Package Marking Information

10-Lead MSOP

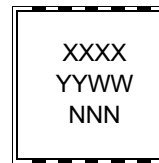


Example:

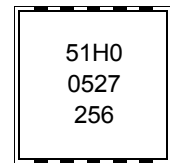


5 = TC1313  
 1 = 1.375V  $V_{OUT1}$   
 H = 2.6V  $V_{OUT2}$   
 0 = Default

10-Lead DFN



Example:



Second letter represents  $V_{OUT1}$  configuration:

Code	$V_{OUT1}$	Code	$V_{OUT1}$	Code	$V_{OUT1}$
A	3.3V	J	2.4V	S	1.5V
B	3.2V	K	2.3V	T	1.4V
C	3.1V	L	2.2V	U	1.3V
D	3.0V	M	2.1V	V	1.2V
E	2.9V	N	2.0V	W	1.1V
F	2.8V	O	1.9V	X	1.0V
G	2.7V	P	1.8V	Y	0.9V
H	2.6V	Q	1.7V	Z	Adj
I	2.5V	R	1.6V	1	1.375V

Third letter represents  $V_{OUT2}$  configuration:

Code	$V_{OUT2}$	Code	$V_{OUT2}$	Code	$V_{OUT2}$
A	3.3V	J	2.4V	S	1.5V
B	3.2V	K	2.3V	T	—
C	3.1V	L	2.2V	U	—
D	3.0V	M	2.1V	V	—
E	2.9V	N	2.0V	W	—
F	2.8V	O	1.9V	X	—
G	2.7V	P	1.8V	Y	—
H	2.6V	Q	1.7V	Z	—
I	2.5V	R	1.6V		

Fourth letter represents +50 mV Increments:

Code		Code	
0	Default	2	+50 mV to V2
1	+50 mV to V1	3	+50 mV to V1 and V2

**Legend:** XX...X Customer-specific information  
 Y Year code (last digit of calendar year)  
 YY Year code (last 2 digits of calendar year)  
 WW Week code (week of January 1 is week '01')  
 NNN Alphanumeric traceability code  
 (e3) Pb-free JEDEC designator for Matte Tin (Sn)  
 \* This package is Pb-free. The Pb-free JEDEC designator (e3) can be found on the outer packaging for this package.

**Note:** In the event the full Microchip part number cannot be marked on one line, it will be carried over to the next line, thus limiting the number of available characters for customer-specific information.

# TC1313

## 10-Lead Plastic Dual Flat, No Lead Package (MF) – 3x3x0.9 mm Body [DFN]

**Note:** For the most current package drawings, please see the Microchip Packaging Specification located at <http://www.microchip.com/packaging>



Dimension Limits	Units	MILLIMETERS		
		MIN	NOM	MAX
Number of Pins	N	10		
Pitch	e	0.50 BSC		
Overall Height	A	0.80	0.90	1.00
Standoff	A1	0.00	0.02	0.05
Contact Thickness	A3	0.20 REF		
Overall Length	D	3.00 BSC		
Exposed Pad Length	D2	2.20	2.35	2.48
Overall Width	E	3.00 BSC		
Exposed Pad Width	E2	1.40	1.58	1.75
Contact Width	b	0.18	0.25	0.30
Contact Length	L	0.30	0.40	0.50
Contact-to-Exposed Pad	K	0.20	-	-

**Notes:**

- Pin 1 visual index feature may vary, but must be located within the hatched area.
- Package may have one or more exposed tie bars at ends.
- Package is saw singulated.
- Dimensioning and tolerancing per ASME Y14.5M.

BSC: Basic Dimension. Theoretically exact value shown without tolerances.

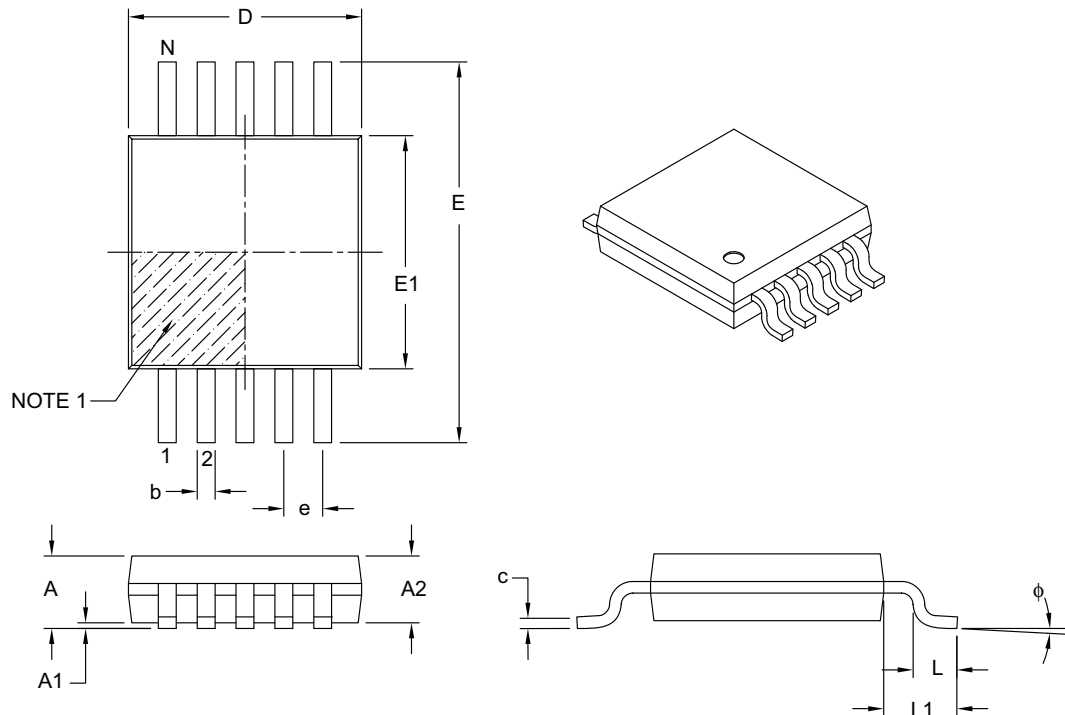
REF: Reference Dimension, usually without tolerance, for information purposes only.

Microchip Technology Drawing C04-063B



## 10-Lead Plastic Micro Small Outline Package (UN) [MSOP]

**Note:** For the most current package drawings, please see the Microchip Packaging Specification located at <http://www.microchip.com/packaging>



Dimension Limits	Units	MILLIMETERS		
		MIN	NOM	MAX
Number of Pins	N	10		
Pitch	e	0.50 BSC		
Overall Height	A	–	–	1.10
Molded Package Thickness	A2	0.75	0.85	0.95
Standoff	A1	0.00	–	0.15
Overall Width	E	4.90 BSC		
Molded Package Width	E1	3.00 BSC		
Overall Length	D	3.00 BSC		
Foot Length	L	0.40	0.60	0.80
Footprint	L1	0.95 REF		
Foot Angle	$\phi$	0°	–	8°
Lead Thickness	c	0.08	–	0.23
Lead Width	b	0.15	–	0.33

**Notes:**

- Pin 1 visual index feature may vary, but must be located within the hatched area.
- Dimensions D and E1 do not include mold flash or protrusions. Mold flash or protrusions shall not exceed 0.15 mm per side.
- Dimensioning and tolerancing per ASME Y14.5M.

BSC: Basic Dimension. Theoretically exact value shown without tolerances.

REF: Reference Dimension, usually without tolerance, for information purposes only.

Microchip Technology Drawing C04-021B

# TC1313

---

NOTES:

## **APPENDIX A: REVISION HISTORY**

### **Revision B (January 2009)**

The following is the list of modifications:

1. Added the new DFN package information.

### **Revision A (November 2005)**

- Original Release of this Document.

# TC1313

---

NOTES:

## PRODUCT IDENTIFICATION SYSTEM

To order or obtain information, e.g., on pricing or delivery, refer to the factory or the listed sales office.

PART NO.	X	X	X	X	XX	XX	Examples:	
TC1313	V <sub>OUT1</sub>	V <sub>OUT2</sub>	+50 mV Increments	Temp Range	Package	Tube or Tape & Reel		
Device: TC1313: PWM/LDO combo.								
Options	Code	V <sub>OUT1</sub>	Code	V <sub>OUT2</sub>	Code	+50 mV		
	A	3.3V	A	3.3V	0	Default	a) TC1313-1H0EMF: 1.375V, 2.6V, Default, 10LD DFN pkg.	
	B	3.2V	B	3.2V	1	V1 + 50 mV	b) TC1313-1H0EUN: 1.375V, 2.6V, Default, 10LD MSOP pkg.	
	C	3.1V	C	3.1V	2	V2 + 50 mV	c) TC1313-1P0EMF: 1.375V, 1.8V, Default, 10LD DFN pkg.	
	D	3.0V	D	3.0V	3	V1 and V2 + 50 mV	d) TC1313-1P0EUN: 1.375V, 1.8V, Default, 10LD MSOP pkg.	
	E	2.9V	E	2.9V			e) TC1313-DG0EMF: 3.0V, 2.7V, Default, 10LD DFN pkg.	
	F	2.8V	F	2.8V			f) TC1313-RD1EMF: 1.65V, 3.0V, 10LD DFN pkg.	
	G	2.7V	G	2.7V			g) TC1313-ZS0EUN: Adj., 1.5V, Default, 10LD MSOP pkg.	
	H	2.6V	H	2.6V			h) TC1313-1H0EMFTR: 1.375V, 2.6V, Default, 10LD DFN pkg	
	I	2.5V	I	2.5V			Tape and Reel.	
	J	2.4V	J	2.4V			i) TC1313-1H0EUNTR: 1.375V, 2.6V, Default, 10LD MSOP pkg	
	K	2.3V	K	2.3V			Tape and Reel.	
	L	2.2V	L	2.2V			j) TC1313-1P0EMFTR: 1.375V, 1.8V, Default, 10LD DFN pkg	
	M	2.1V	M	2.1V			Tape and Reel.	
	N	2.0V	N	2.0V			k) TC1313-1P0EUNTR: 1.375V, 1.8V, Default, 10LD MSOP pkg	
	O	1.9V	O	1.9V			Tape and Reel.	
	P	1.8V	P	1.8V			l) TC1313-DG0EMFTR: 3.0V, 2.7V, Default, 10LD DFN pkg	
	Q	1.7V	Q	1.7V			Tape and Reel.	
	R	1.6V	R	1.6V			m) TC1313-RD1EMFTR: 1.65V, 3.0V, 10LD DFN pkg	
	S	1.5V	S	1.5V			Tape and Reel.	
	T	1.4V	T				n) TC1313-ZS0EUNTR: Adj., 1.5V, Default, 10LD MSOP pkg	
	U	1.3V	U				Tape and Reel.	
	V	1.2V	V					
	W	1.1V	W					
	X	1.0V	X					
	Y	0.9V	Y					
	Z	Adjustable	Z					
	1	1.375V	1					
* Contact Factory for Alternate Output Voltage and Reset Voltage Configurations.								
Temperature Range:	E	= -40°C to +85°C						
Package:	MF	= Dual Flat, No Lead (3x3 mm body), 10-lead						
	UN	= Plastic Micro Small Outline (MSOP), 10-lead						
Tube or Tape and Reel:	Blank	= Tube						
	TR	= Tape and Reel						

# TC1313

---

NOTES:

---

**Note the following details of the code protection feature on Microchip devices:**

- Microchip products meet the specification contained in their particular Microchip Data Sheet.
- Microchip believes that its family of products is one of the most secure families of its kind on the market today, when used in the intended manner and under normal conditions.
- There are dishonest and possibly illegal methods used to breach the code protection feature. All of these methods, to our knowledge, require using the Microchip products in a manner outside the operating specifications contained in Microchip's Data Sheets. Most likely, the person doing so is engaged in theft of intellectual property.
- Microchip is willing to work with the customer who is concerned about the integrity of their code.
- Neither Microchip nor any other semiconductor manufacturer can guarantee the security of their code. Code protection does not mean that we are guaranteeing the product as “unbreakable.”

Code protection is constantly evolving. We at Microchip are committed to continuously improving the code protection features of our products. Attempts to break Microchip's code protection feature may be a violation of the Digital Millennium Copyright Act. If such acts allow unauthorized access to your software or other copyrighted work, you may have a right to sue for relief under that Act.

---

Information contained in this publication regarding device applications and the like is provided only for your convenience and may be superseded by updates. It is your responsibility to ensure that your application meets with your specifications. MICROCHIP MAKES NO REPRESENTATIONS OR WARRANTIES OF ANY KIND WHETHER EXPRESS OR IMPLIED, WRITTEN OR ORAL, STATUTORY OR OTHERWISE, RELATED TO THE INFORMATION, INCLUDING BUT NOT LIMITED TO ITS CONDITION, QUALITY, PERFORMANCE, MERCHANTABILITY OR FITNESS FOR PURPOSE. Microchip disclaims all liability arising from this information and its use. Use of Microchip devices in life support and/or safety applications is entirely at the buyer's risk, and the buyer agrees to defend, indemnify and hold harmless Microchip from any and all damages, claims, suits, or expenses resulting from such use. No licenses are conveyed, implicitly or otherwise, under any Microchip intellectual property rights.

**Trademarks**

The Microchip name and logo, the Microchip logo, Accuron, dsPIC, KEELOQ, KEELOQ logo, MPLAB, PIC, PICmicro, PICSTART, rfPIC, SmartShunt and UNI/O are registered trademarks of Microchip Technology Incorporated in the U.S.A. and other countries.

FilterLab, Linear Active Thermistor, MXDEV, MXLAB, SEEVAL, SmartSensor and The Embedded Control Solutions Company are registered trademarks of Microchip Technology Incorporated in the U.S.A.

Analog-for-the-Digital Age, Application Maestro, CodeGuard, dsPICDEM, dsPICDEM.net, dsPICworks, dsSPEAK, ECAN, ECONOMONITOR, FanSense, In-Circuit Serial Programming, ICSP, ICEPIC, Mindi, MiWi, MPASM, MPLAB Certified logo, MPLIB, MPLINK, mTouch, PICkit, PICDEM, PICDEM.net, PICtail, PIC<sup>32</sup> logo, PowerCal, PowerInfo, PowerMate, PowerTool, REAL ICE, rLAB, Select Mode, Total Endurance, WiperLock and ZENA are trademarks of Microchip Technology Incorporated in the U.S.A. and other countries.

SQTP is a service mark of Microchip Technology Incorporated in the U.S.A.

All other trademarks mentioned herein are property of their respective companies.

© 2009, Microchip Technology Incorporated, Printed in the U.S.A., All Rights Reserved.

 Printed on recycled paper.

**QUALITY MANAGEMENT SYSTEM**  
**CERTIFIED BY DNV**  
**== ISO/TS 16949:2002 ==**

*Microchip received ISO/TS-16949:2002 certification for its worldwide headquarters, design and wafer fabrication facilities in Chandler and Tempe, Arizona; Gresham, Oregon and design centers in California and India. The Company's quality system processes and procedures are for its PIC® MCUs and dsPIC® DSCs, KEELOQ® code hopping devices, Serial EEPROMs, microperipherals, nonvolatile memory and analog products. In addition, Microchip's quality system for the design and manufacture of development systems is ISO 9001:2000 certified.*



## WORLDWIDE SALES AND SERVICE

### AMERICAS

**Corporate Office**  
2355 West Chandler Blvd.  
Chandler, AZ 85224-6199  
Tel: 480-792-7200  
Fax: 480-792-7277  
Technical Support:  
<http://support.microchip.com>  
Web Address:  
[www.microchip.com](http://www.microchip.com)

**Atlanta**  
Duluth, GA  
Tel: 678-957-9614  
Fax: 678-957-1455

**Boston**  
Westborough, MA  
Tel: 774-760-0087  
Fax: 774-760-0088

**Chicago**  
Itasca, IL  
Tel: 630-285-0071  
Fax: 630-285-0075

**Dallas**  
Addison, TX  
Tel: 972-818-7423  
Fax: 972-818-2924

**Detroit**  
Farmington Hills, MI  
Tel: 248-538-2250  
Fax: 248-538-2260

**Kokomo**  
Kokomo, IN  
Tel: 765-864-8360  
Fax: 765-864-8387

**Los Angeles**  
Mission Viejo, CA  
Tel: 949-462-9523  
Fax: 949-462-9608

**Santa Clara**  
Santa Clara, CA  
Tel: 408-961-6444  
Fax: 408-961-6445

**Toronto**  
Mississauga, Ontario,  
Canada  
Tel: 905-673-0699  
Fax: 905-673-6509

### ASIA/PACIFIC

**Asia Pacific Office**  
Suites 3707-14, 37th Floor  
Tower 6, The Gateway  
Harbour City, Kowloon  
Hong Kong  
Tel: 852-2401-1200  
Fax: 852-2401-3431

**Australia - Sydney**  
Tel: 61-2-9868-6733  
Fax: 61-2-9868-6755

**China - Beijing**  
Tel: 86-10-8528-2100  
Fax: 86-10-8528-2104

**China - Chengdu**  
Tel: 86-28-8665-5511  
Fax: 86-28-8665-7889

**China - Hong Kong SAR**  
Tel: 852-2401-1200  
Fax: 852-2401-3431

**China - Nanjing**  
Tel: 86-25-8473-2460  
Fax: 86-25-8473-2470

**China - Qingdao**  
Tel: 86-532-8502-7355  
Fax: 86-532-8502-7205

**China - Shanghai**  
Tel: 86-21-5407-5533  
Fax: 86-21-5407-5066

**China - Shenyang**  
Tel: 86-24-2334-2829  
Fax: 86-24-2334-2393

**China - Shenzhen**  
Tel: 86-755-8203-2660  
Fax: 86-755-8203-1760

**China - Wuhan**  
Tel: 86-27-5980-5300  
Fax: 86-27-5980-5118

**China - Xiamen**  
Tel: 86-592-2388138  
Fax: 86-592-238813S0

**China - Xian**  
Tel: 86-29-8833-7252  
Fax: 86-29-8833-7256

**China - Zhuhai**  
Tel: 86-756-3210040  
Fax: 86-756-3210049

### ASIA/PACIFIC

**India - Bangalore**  
Tel: 91-80-4182-8400  
Fax: 91-80-4182-8422

**India - New Delhi**  
Tel: 91-11-4160-8631  
Fax: 91-11-4160-8632

**India - Pune**  
Tel: 91-20-2566-1512  
Fax: 91-20-2566-1513

**Japan - Yokohama**  
Tel: 81-45-471- 6166  
Fax: 81-45-471-6122

**Korea - Daegu**  
Tel: 82-53-744-4301  
Fax: 82-53-744-4302

**Korea - Seoul**  
Tel: 82-2-554-7200  
Fax: 82-2-558-5932 or  
82-2-558-5934

**Malaysia - Kuala Lumpur**  
Tel: 60-3-6201-9857  
Fax: 60-3-6201-9859

**Malaysia - Penang**  
Tel: 60-4-227-8870  
Fax: 60-4-227-4068

**Philippines - Manila**  
Tel: 63-2-634-9065  
Fax: 63-2-634-9069

**Singapore**  
Tel: 65-6334-8870  
Fax: 65-6334-8850

**Taiwan - Hsin Chu**  
Tel: 886-3-572-9526  
Fax: 886-3-572-6459

**Taiwan - Kaohsiung**  
Tel: 886-7-536-4818  
Fax: 886-7-536-4803

**Taiwan - Taipei**  
Tel: 886-2-2500-6610  
Fax: 886-2-2508-0102

**Thailand - Bangkok**  
Tel: 66-2-694-1351  
Fax: 66-2-694-1350

### EUROPE

**Austria - Wels**  
Tel: 43-7242-2244-39  
Fax: 43-7242-2244-393

**Denmark - Copenhagen**  
Tel: 45-4450-2828  
Fax: 45-4485-2829

**France - Paris**  
Tel: 33-1-69-53-63-20  
Fax: 33-1-69-30-90-79

**Germany - Munich**  
Tel: 49-89-627-144-0  
Fax: 49-89-627-144-44

**Italy - Milan**  
Tel: 39-0331-742611  
Fax: 39-0331-466781

**Netherlands - Drunen**  
Tel: 31-416-690399  
Fax: 31-416-690340

**Spain - Madrid**  
Tel: 34-91-708-08-90  
Fax: 34-91-708-08-91

**UK - Wokingham**  
Tel: 44-118-921-5869  
Fax: 44-118-921-5820





Компания «ЭлектроПласт» предлагает заключение долгосрочных отношений при поставках импортных электронных компонентов на взаимовыгодных условиях!

Наши преимущества:

- Оперативные поставки широкого спектра электронных компонентов отечественного и импортного производства напрямую от производителей и с крупнейших мировых складов;
- Поставка более 17-ти миллионов наименований электронных компонентов;
- Поставка сложных, дефицитных, либо снятых с производства позиций;
- Оперативные сроки поставки под заказ (от 5 рабочих дней);
- Экспресс доставка в любую точку России;
- Техническая поддержка проекта, помощь в подборе аналогов, поставка прототипов;
- Система менеджмента качества сертифицирована по Международному стандарту ISO 9001;
- Лицензия ФСБ на осуществление работ с использованием сведений, составляющих государственную тайну;
- Поставка специализированных компонентов (Xilinx, Altera, Analog Devices, Intersil, Interpoint, Microsemi, Aeroflex, Peregrine, Syfer, Eurofarad, Texas Instrument, Miteq, Cobham, E2V, MA-COM, Hittite, Mini-Circuits, General Dynamics и др.);

Помимо этого, одним из направлений компании «ЭлектроПласт» является направление «Источники питания». Мы предлагаем Вам помощь Конструкторского отдела:

- Подбор оптимального решения, техническое обоснование при выборе компонента;
- Подбор аналогов;
- Консультации по применению компонента;
- Поставка образцов и прототипов;
- Техническая поддержка проекта;
- Защита от снятия компонента с производства.



#### Как с нами связаться

**Телефон:** 8 (812) 309 58 32 (многоканальный)

**Факс:** 8 (812) 320-02-42

**Электронная почта:** [org@eplast1.ru](mailto:org@eplast1.ru)

**Адрес:** 198099, г. Санкт-Петербург, ул. Калинина, дом 2, корпус 4, литера А.