



FEATURES

- UL 60950 recognised³
- Single Isolated output
- 1kVDC or 3kVDC option 'Hi Pot Test'
- Wide temperature performance at full 1W load -40°C to 85°C⁴
- Industry Standard Pinout
- 3.3V, 5V, 12V & 24V Inputs
- 5V, 12V & 15V outputs
- Pin Compatible with CME, CRL2, LME, MEE1, MEE3, MTE1, NKE, NME, NML & NTE series
- Through hole and surface mount options available

PRODUCT OVERVIEW

The CRE1 series are a cost effective 1W DC-DC converter series, in industry standard packages with industry standard pinout. Popular input and output voltages are available. The galvanic isolation allows the device to be configured to provide an isolated negative rail in systems where only positive rails exist. The wide temperature range guarantees startup from -40°C and full 1 watt output at 85°C³.

SELECTION GUIDE

Order Code ¹	Nominal Input Voltage	Output Voltage	Output Current	Load Regulation		Ripple & Noise		Input Current at Rated Load	Efficiency		Isolation Capacitance	MTTF ²		
				%		mV p-p			%			pF	MIL. kHrs	Tel. kHrs
				Typ.	Max.	Typ.	Max.		Min.	Typ.				
CRE1S0505DC	5	5	200	12	14	16	40	286	65	70	30			
CRE1S0505SC	5	5	200	12	14	16	40	286	65	70	30			
CRE1S0515SC	5	15	67	6	7.5	10	25	250	77	80	40			
CRE1S1205SC	12	5	200	8	10	12	30	117	68	71	33			
CRE1S1212SC	12	12	83	4	5	8	20	104	75	80	55			
CRE1S2405SC	24	5	200	8.5	10	13	30	58	67	71	40			
CRE1S2412SC	24	12	83	3	4	10	25	52	75	80	78			
3KVDC isolation options														
CRE1S0305S3C	3.3	5	200	10	12	15	25	400	72	75	35			
CRE1S0505S3C	5	5	200	6	8	15	25	250	73	77	24			
Surface mount options														
CRE1S0505MC	5	5	200	12.8	15	62	85	294		68	35	6857		
CRE1S0505MEC	5	5	200	6.5	8	25	70	239	79	82	22	3041		

INPUT CHARACTERISTICS

Parameter	Conditions	Min.	Typ.	Max.	Units
Voltage range	Continuous operation, 3.3V input types	2.97	3.3	3.63	V
	Continuous operation, 5V input types	4.5	5.0	5.5	
	Continuous operation, 12V input types	10.8	12	13.2	
	Continuous operation, 24V input types	21.6	24	26.4	
Reflected ripple current	3.3V & 12V input types		1	15	mA p-p
	5V & 24V input types		2	15	
	CRE1S0505MC		30	47	
	CRE1S0505MEC		5	15	

OUTPUT CHARACTERISTICS

Parameter	Conditions	Min.	Typ.	Max.	Units
Rated Power	T _A = -40°C to 85°C ³			1	W
Voltage Set Point Accuracy	See tolerance envelope				
Line regulation	High V _{in} to low V _{in}		1.1	1.2	%/%

ISOLATION CHARACTERISTICS

Parameter	Conditions	Min.	Typ.	Max.	Units
Isolation test voltage	C Versions Flash tested for 1 second	1000			VDC
	3C Versions Flash tested for 1 second	3000			
Resistance	Viso = 1000VDC		10		GΩ

GENERAL CHARACTERISTICS

Parameter	Conditions	Min.	Typ.	Max.	Units
Switching frequency	3.3V input types		115		kHz
	5V input types		110		
	12V input types		145		
	24V input types		100		
	CRE1S0505MEC		80		

1. If components are required in tape and reel format suffix order code with -R, e.g. CRE1S0505MC-R.
2. Calculated using MIL-HDBK-217 FN2 and Telcordia SR-332 calculation model with nominal input voltage at full load.
3. UL 60950 recognition does not apply to CRE1S0505MC.
4. 24V input parts prior to date code D1635 have operating temperature range of 0 to 70°C.

All specifications typical at T_A = 25°C, nominal input voltage and rated output current unless otherwise specified.



ABSOLUTE MAXIMUM RATINGS

Lead temperature 1.5mm from case for 10 seconds	260°C
Input voltage V_{IN} , 3.3V input	5.5V
Input voltage V_{IN} , 5V input	7V
Input voltage V_{IN} , 12V input	15V
Input voltage V_{IN} , 24V input	28V

TEMPERATURE CHARACTERISTICS

Parameter	Conditions	Min.	Typ.	Max.	Units
Specification	All output types ¹	-40		85	°C
Storage		-50		130	
Case temperature rise above ambient	5V output types			41	
	All other output types			32	
	CRE1S0505MC		43		
	CRE1S0505MEC		12.5		
Cooling	Free air convection				

TECHNICAL NOTES

ISOLATION VOLTAGE

'Hi Pot Test', 'Flash Tested', 'Withstand Voltage', 'Proof Voltage', 'Dielectric Withstand Voltage' & 'Isolation Test Voltage' are all terms that relate to the same thing, a test voltage, applied for a specified time, across a component designed to provide electrical isolation, to verify the integrity of that isolation.

Murata Power Solutions CRE1 series of DC-DC converters are all 100% production tested at their stated isolation voltage. This is 1kVDC for 1 second for C versions and 3kVDC for 1 second for 3C versions.

A question commonly asked is, "What is the continuous voltage that can be applied across the part in normal operation?"

The CRE1 series, through hole variants (excluding surface mount variants) have been recognised by Underwriters Laboratory for functional insulation, both input and output should normally be maintained within SELV limits i.e. less than 42.4V peak, or 60VDC. The isolation test voltage represents a measure of immunity to transient voltages and the part should never be used as an element of a safety isolation system. The part could be expected to function correctly with several hundred volts offset applied continuously across the isolation barrier; but then the circuitry on both sides of the barrier must be regarded as operating at an unsafe voltage and further isolation/insulation systems must form a barrier between these circuits and any user-accessible circuitry according to safety standard requirements.

REPEATED HIGH-VOLTAGE ISOLATION TESTING

It is well known that repeated high-voltage isolation testing of a barrier component can actually degrade isolation capability, to a lesser or greater degree depending on materials, construction and environment. The CRE1 series has toroidal isolation transformers, with no additional insulation between primary and secondary windings of enamelled wire. While parts can be expected to withstand several times the stated test voltage, the isolation capability does depend on the wire insulation. Any material, including this enamel (typically polyurethane) is susceptible to eventual chemical degradation when subject to very high applied voltages thus implying that the number of tests should be strictly limited. We therefore strongly advise against repeated high voltage isolation testing, but if it is absolutely required, that the voltage be reduced by 20% from specified test voltage.

This consideration equally applies to agency recognized parts rated for better than functional isolation where the wire enamel insulation is always supplemented by a further insulation system of physical spacing or barriers.

SAFETY APPROVAL

The CRE1 series has been recognised by Underwriters Laboratory (UL) to UL60950 for functional insulation in a maximum still air ambient temperature of 100°C for the C versions and 130°C for the 3C versions as measured on the case of the unit (hotspot). The CRE1S0505MC is not currently UL recognised.

The CRE1 series of converters are not internally fused so to meet the requirements of UL60950 an anti-surge input line fuse should always be used with ratings as defined below.

CRE1S03xxS3C: 1A
 CRE1S05xxxxC: 0.7A
 CRE1S12xxSC: 0.2A
 CRE1S24xxSC: 0.16A

All fuses should be UL recognised, 125V rated.

File number E151252 applies.

1. 24V input parts prior to date code D1635 have operating temperature range of 0 to 70°C.

TEMPERATURE DERATING GRAPH - Surface Mount & 3C types

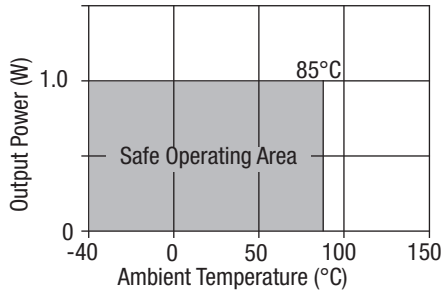

TEMPERATURE DERATING GRAPH - All other types¹

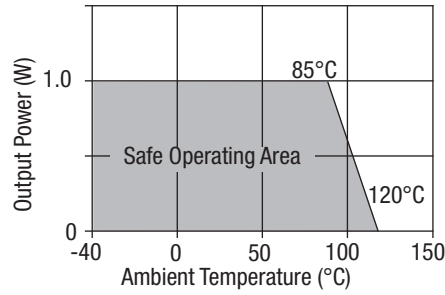

EFFICIENCY VS LOAD

3.3V Inputs

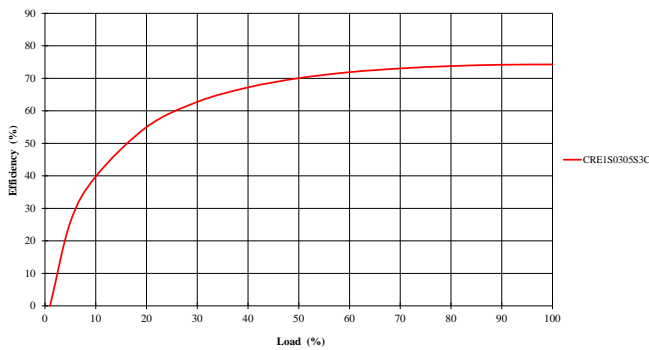

5V Inputs

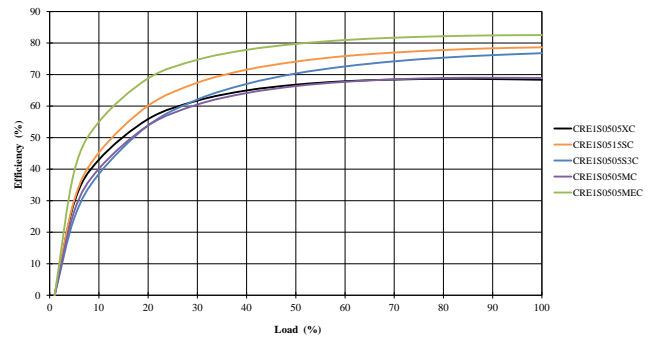

12V Inputs

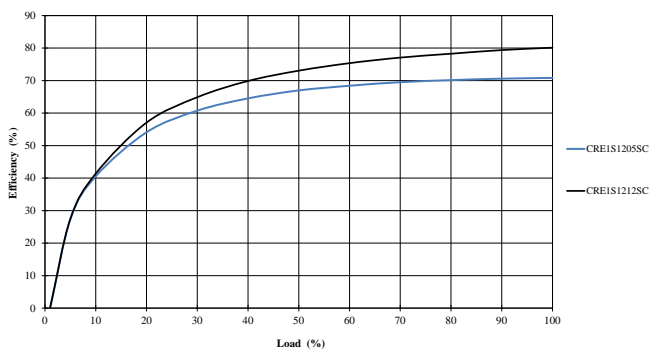

24V Inputs

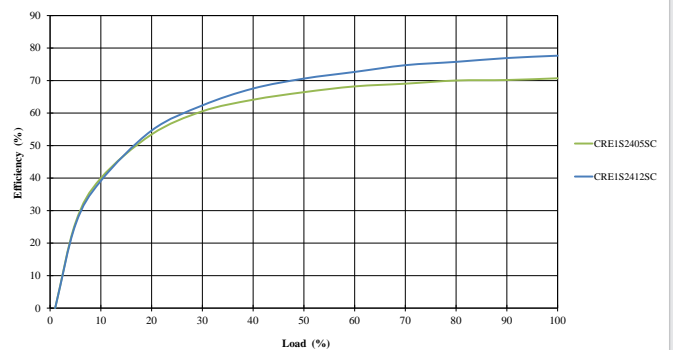

1. 24V input parts prior to date code D1635 have operating temperature range of 0 to 70°C.

TOLERANCE ENVELOPES

The voltage tolerance envelope shows typical load regulation characteristics for this product series. The tolerance envelope is the maximum output voltage variation due to changes in output loading.

CRE1S0505XC

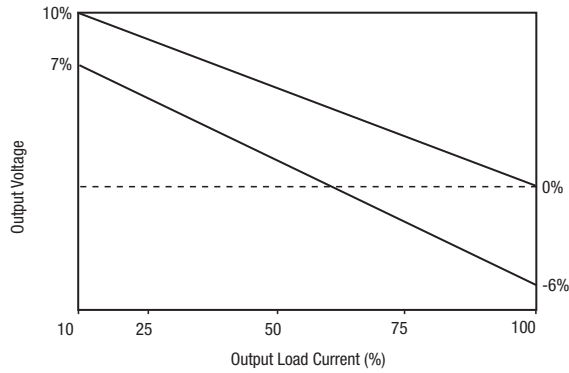

CRE1S0515SC

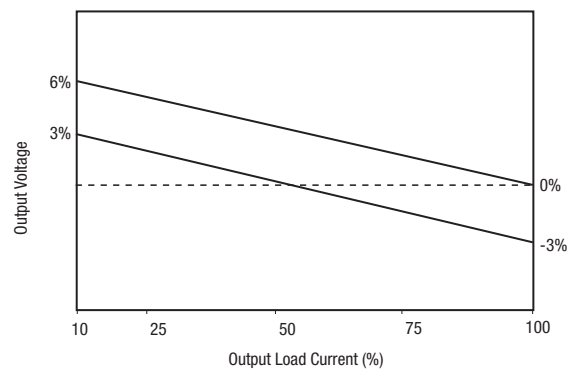

CRE1S1205SC

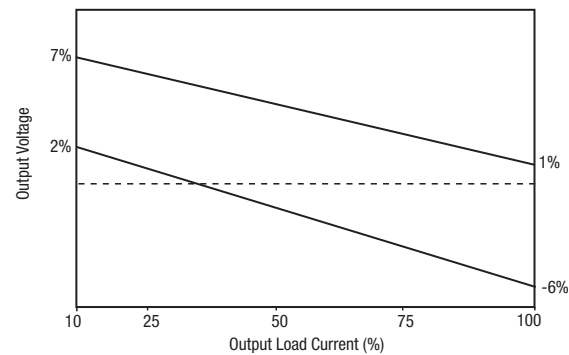

CRE1S1212SC

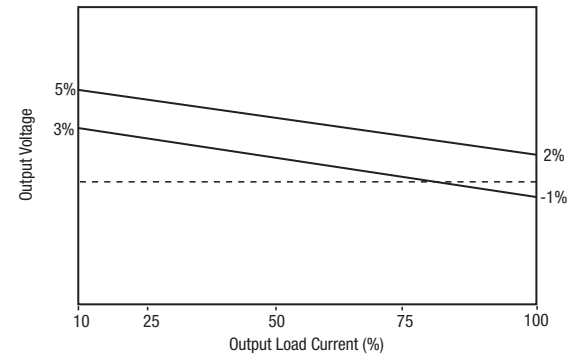

CRE1S2405SC

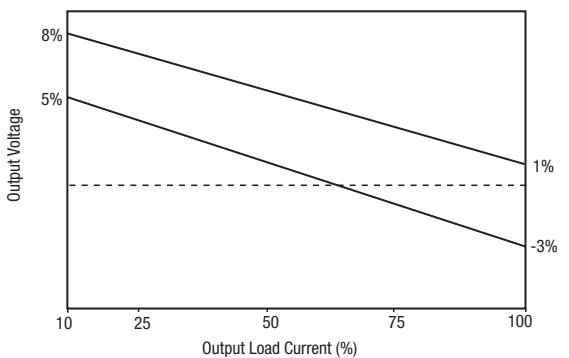

CRE1S2412SC

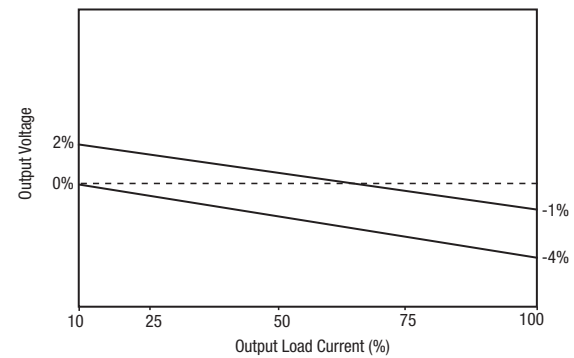

TOLERANCE ENVELOPES (continued)

CRE1S0305S3C

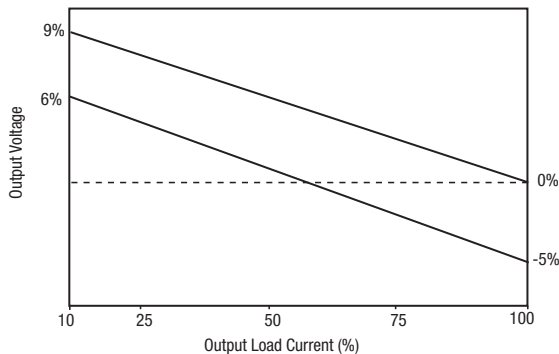

CRE1S0505S3C

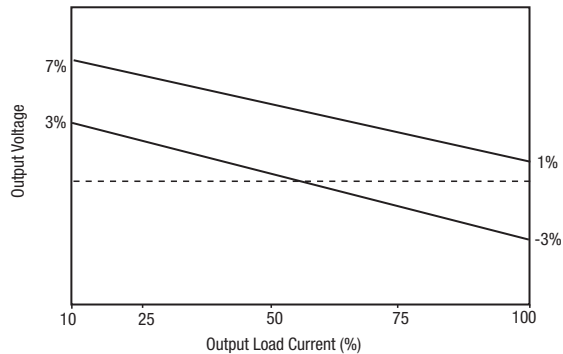

CRE1S0505MC

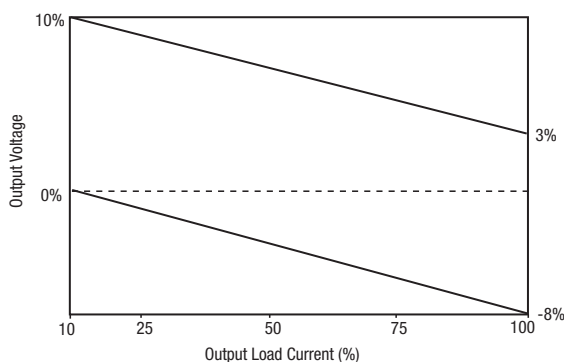

CRE1S0505MEC

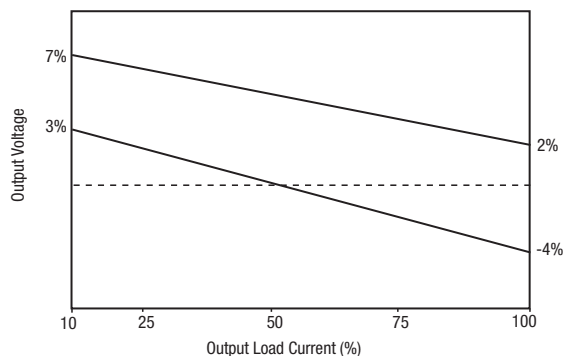

RoHS COMPLIANCE and MSL INFORMATION



The Through Hole parts (SIP/DIP) in this series are compatible with RoHS soldering systems with a peak wave solder temperature of 260°C for 10 seconds. The pin termination finish on the SIP package type is Tin Plate, Hot Dipped over Matte Tin with Nickel Preplate. The DIP types are Matte Tin over Nickel Preplate. This series is backward compatible with Sn/Pb soldering systems.

The Surface Mount parts (MC/MEC) in this series are compatible with RoHS soldering systems as per J-STD-020D.1 The pin termination finish on the Surface Mount package types is Matte Tin over Nickel Preplate. This series is backward compatible with Sn/Pb soldering systems. The Surface Mount parts have a Moisture Sensitivity Level (MSL) 1.

Samples of the Surface Mount parts were tested in accordance with the conditioning described for MSL level 1 in IDC/J-STD-020D.1. The products passed electrical tests and visual inspection criteria.

For further information, please visit www.murata-ps.com/rohs

APPLICATION NOTES

Minimum load

The minimum load to meet datasheet specification is 10% of the full rated load across the specified input voltage range. Lower than 10% minimum loading will result in an increase in output voltage, which may rise to typically double the specified output voltage if the output load falls to less than 5%.

Capacitive loading and start up

Typical start up times for this series, with a typical input voltage rise time of 2.2µs and output capacitance of 10µF, are shown in the table below. The product series will start into a capacitance of 47µF with an increased start time, however, the maximum recommended output capacitance is 10µF.

	Start-up time	
	µs	
CRE1S0505DC	190	
CRE1S0505SC	190	
CRE1S0515SC	1790	
CRE1S1205SC	125	
CRE1S1212SC	500	
CRE1S2405SC	135	
CRE1S2412SC	430	
CRE1S0305S3C	295	
CRE1S0505S3C	165	
CRE1S0505MC	1368	
CRE1S0505MEC	170	

Typical Start-Up Wave Form

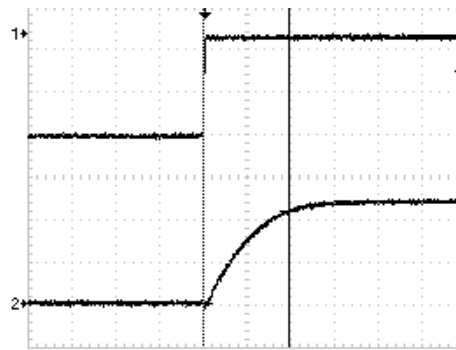

APPLICATION NOTES (continued)

Ripple & Noise Characterisation Method

Ripple and noise measurements are performed with the following test configuration.

C1	1µF X7R multilayer ceramic capacitor, voltage rating to be a minimum of 3 times the output voltage of the DC-DC converter
C2	10µF tantalum capacitor, voltage rating to be a minimum of 1.5 times the output voltage of the DC-DC converter with an ESR of less than 100mΩ at 100 kHz
C3	100nF multilayer ceramic capacitor, general purpose
R1	450Ω resistor, carbon film, ±1% tolerance
R2	50Ω BNC termination
T1	3T of the coax cable through a ferrite toroid
RLOAD	Resistive load to the maximum power rating of the DC-DC converter. Connections should be made via twisted wires

Measured values are multiplied by 10 to obtain the specified values.

Differential Mode Noise Test Schematic

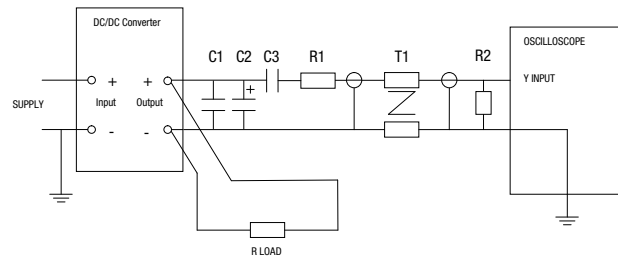

Output Ripple Reduction

By using the values of inductance and capacitance stated, the output ripple at the rated load is lowered to 5mV p-p max.

Component selection

Capacitor: It is required that the ESR (Equivalent Series Resistance) should be as low as possible, ceramic types are recommended. The voltage rating should be at least twice (except for 15V output), the rated output voltage of the DC-DC converter.

Inductor: The rated current of the inductor should not be less than that of the output of the DC-DC converter. At the rated current, the DC resistance of the inductor should be such that the voltage drop across the inductor is <2% of the rated voltage of the DC-DC converter. The SRF (Self Resonant Frequency) should be >20MHz.

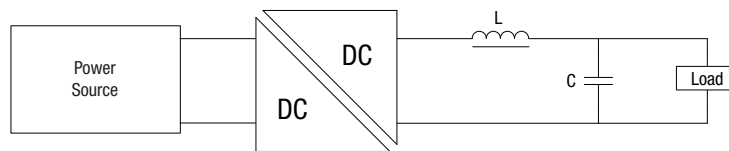

	Inductor			Capacitor
	L, µH	SMD	Through Hole	C, µF
CRE1S0505DC				
CRE1S0505SC				
CRE1S0515SC				
CRE1S1205SC				
CRE1S1212SC				
CRE1S2405SC				
CRE1S2412SC				
CRE1S0305S3C				
CRE1S0505S3C				
CRE1S0505MC	47	82473C	11R473C	4.7
CRE1S0505MEC	10	82103C	11R103C	4.7

EMC FILTERING AND SPECTRA

FILTERING

The following table shows the additional input capacitor and input inductor typically required to meet EN 55022 Curve B Quasi-Peak EMC limit, as shown in the following plots. The following plots show positive and negative quasi peak and CISPR22 Average Limit B (pink line) and Quasi Peak Limit B (green line) adherence limits. The below values are for guidance only and should be evaluated in the application circuit. For the CRE1S0505MEC an input inductor is not required.

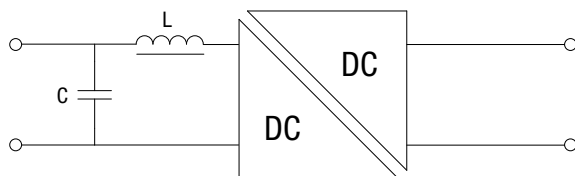

Part Number	Inductor			Capacitor		
	L, μ H	SMD	Through Hole	C, μ F	Rated Voltage	Recommended Part Number
CRE1S0505DC	4.7	82472C	13R472C	4.7	16VDC	GRM188Z71C475ME21
CRE1S0505SC	4.7	82472C	13R472C	4.7	16VDC	GRM188Z71C475ME21
CRE1S0515SC	4.7	82472C	13R472C	4.7	16VDC	GRM188Z71C475ME21
CRE1S1205SC	10	82103C	13R103C	1	50VDC	GRM21BR71H105KA12
CRE1S1212SC	10	82103C	13R103C	1	50VDC	GRM21BR71H105KA12
CRE1S2405SC	22	82223C	13R223C	10	50VDC	GRM32ER71H106MA12
CRE1S2412SC	22	82223C	13R223C	10	50VDC	GRM32ER71H106MA12
CRE1S0305S3C	10	82103C	13R103C	1	50VDC	GRM188R71C105MA12
CRE1S0505S3C	10	82103C	13R103C	1	50VDC	GRM188R71C105MA12
CRE1S0505MC	10	82103C	13R103C	4.7	16VDC	GRM188Z71C475ME21
CRE1S0505MEC	NR	NR	NR	22	10VDC	GRM32ER71A226ME20

NR - Not required

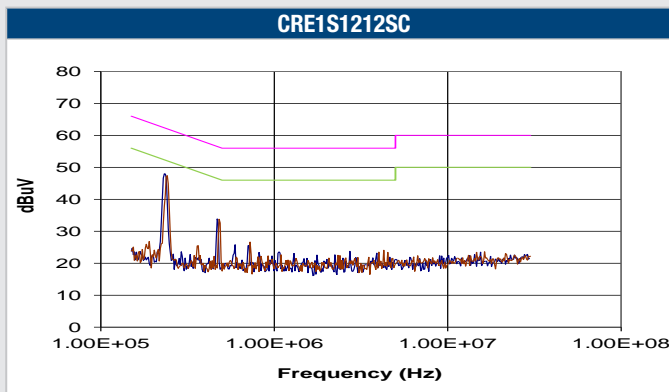
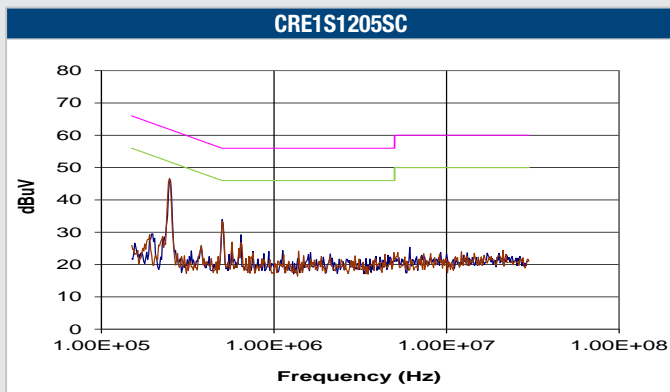
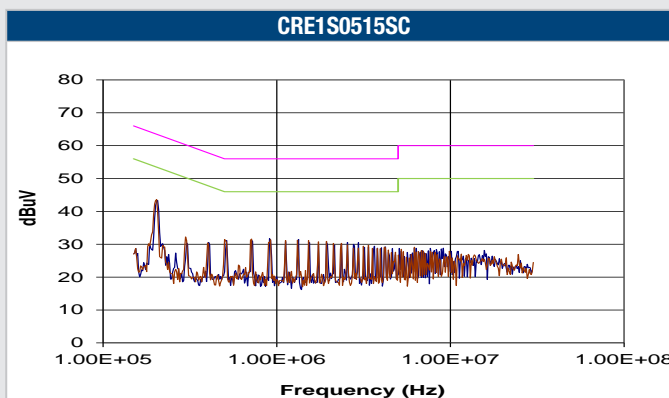
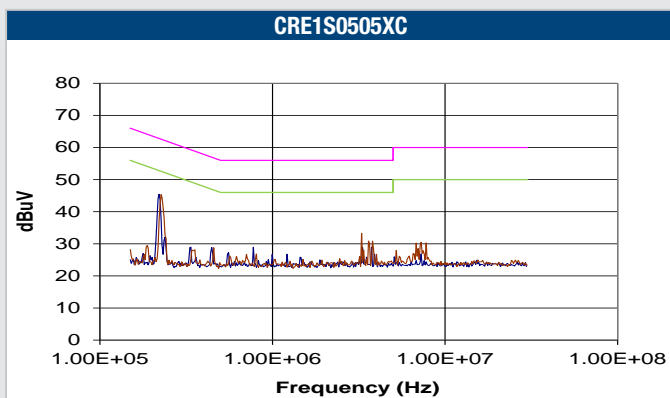

EMC FILTERING AND SPECTRA

CRE1S2405SC

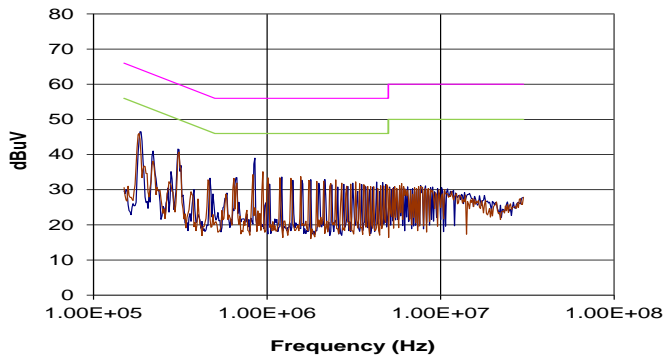

CRE1S2412SC

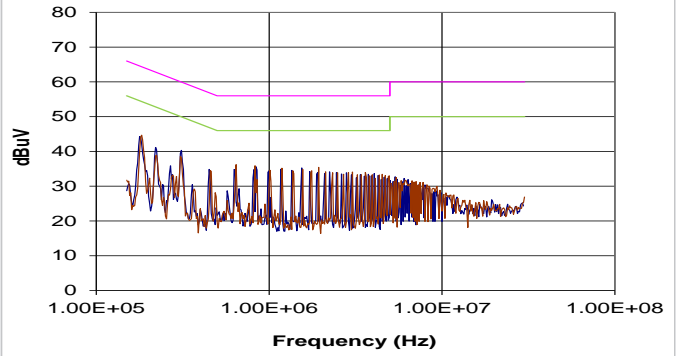

CRE1S0305S3C

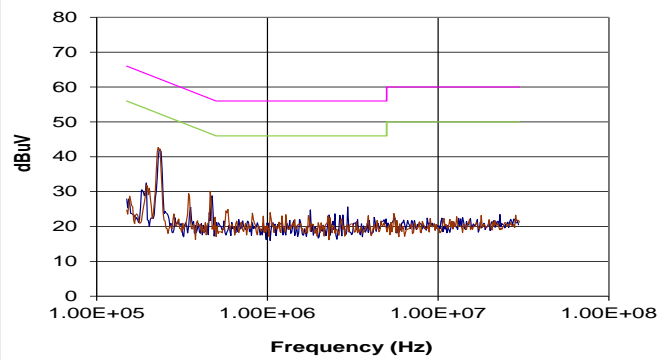

CRE1S0505S3C

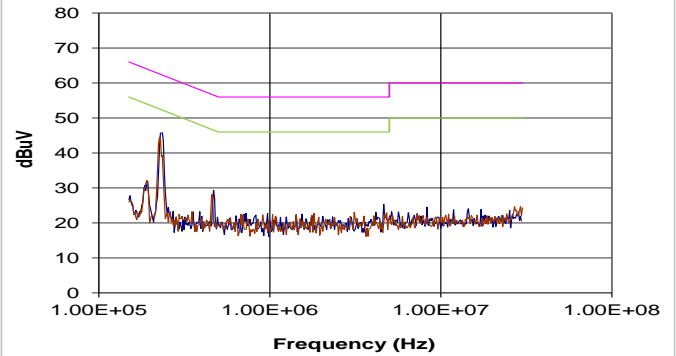

CRE1S0505MC

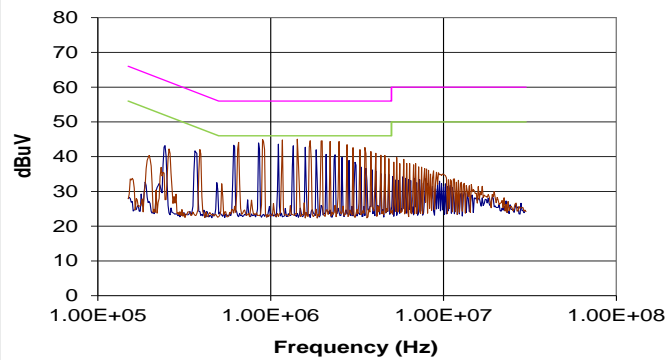

CRE1S0505MEC

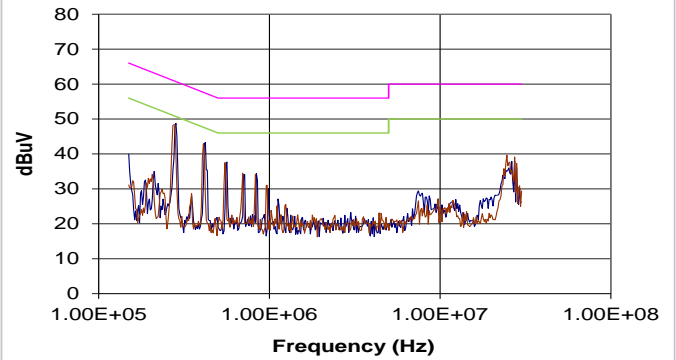

PACKAGE SPECIFICATIONS

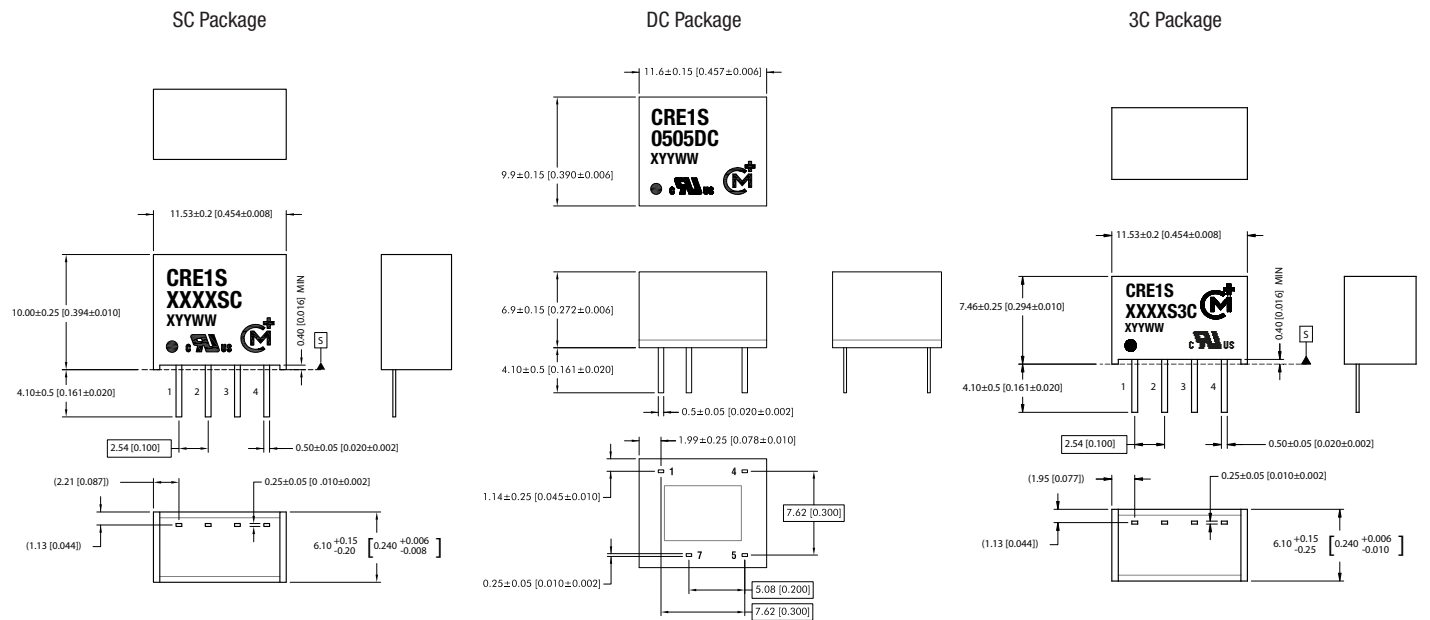

All dimensions in mm (inches) Controlling dimension is mm.

All pins on a 2.54 (0.100) pitch and within ±0.1 (0.004) of true position from pin 1 at seating plane 'S' (SC&3C)

All pins on a 2.54 (0.100) pitch and within ±0.25 (0.010) of true position (DC)

Weight: 1.09g (3C) 1.30g (SC) 1.38g (DC)

PIN CONNECTIONS SC & 3C - 4 PIN SIP

Pin	Function
1	-VIN
2	+VIN
3	-VOUT
4	+VOUT

PIN CONNECTIONS DC - 8 PIN DIP

Pin	Function
1	-VIN
4	+VIN
5	+VOUT
7	-VOUT

PACKAGE SPECIFICATIONS (Continued)

CRE1S0505MC

CRE1S0505MEC

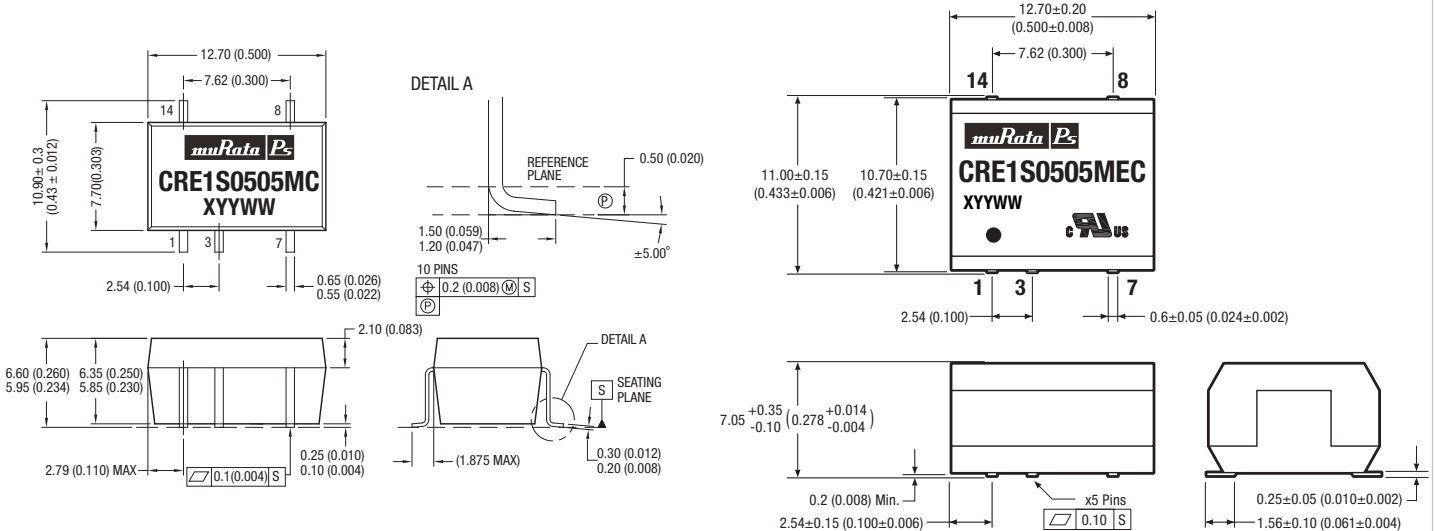

All dimensions in mm (inches) Controlling dimension is mm.
 All pins on a 2.54 (0.100) pitch and within ±0.25 (0.010) of true position

PIN CONNECTIONS - CRE1SXXXMC/MEC

Pin	Function
1	-V _{IN}
3	+V _{IN}
7	-V _{OUT}
8	+V _{OUT}
14	NA

Weight: 1.2g

PACKAGE SPECIFICATIONS (continued)

RECOMMENDED FOOTPRINT DETAILS

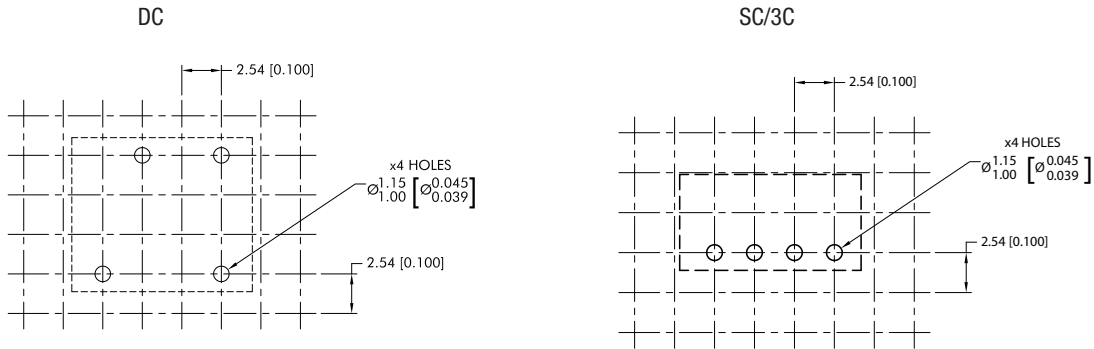

TUBE OUTLINE DIMENSIONS

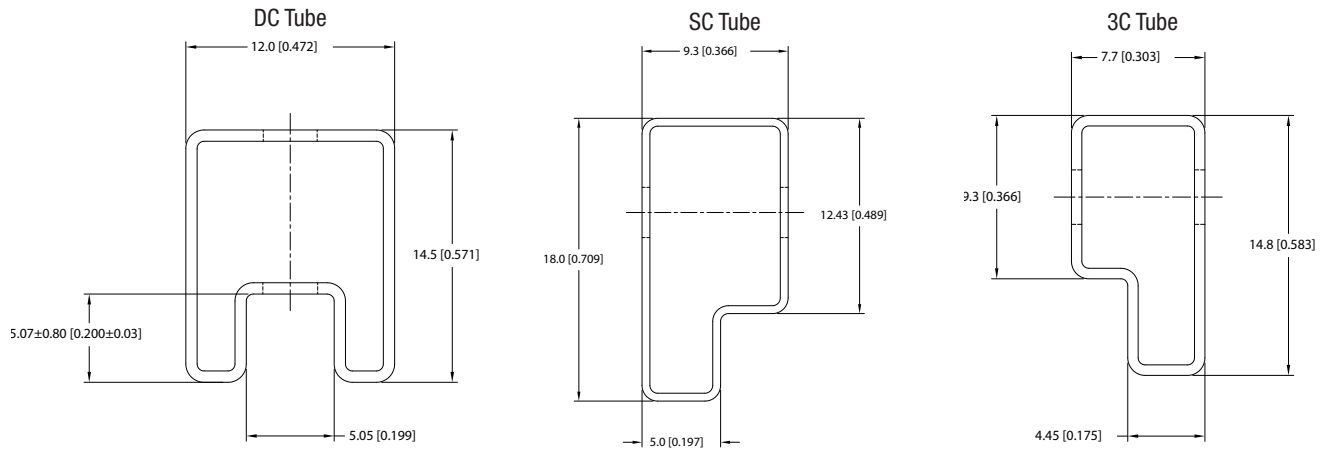

Unless otherwise specified all dimensions in mm [inches] ±0.55mm [0.022].
 Tube Length (DC&SC) : 520mm [20.472] ±2.0 [0.079]
 Tube Length (3C) : 525mm [20.669] ±2.0 [0.079].

Tube Quantity (DC & SC): 35
 (3C):40

PACKAGE SPECIFICATIONS (continued)

RECOMMENDED FOOTPRINT DETAILS

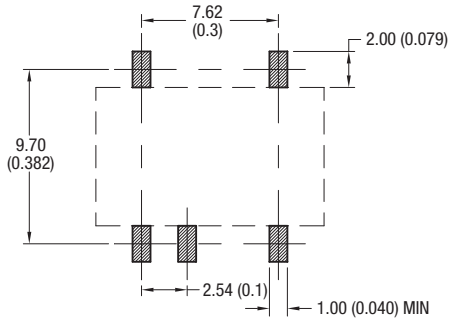

TUBE OUTLINE DIMENSIONS

CRE1S0505MC

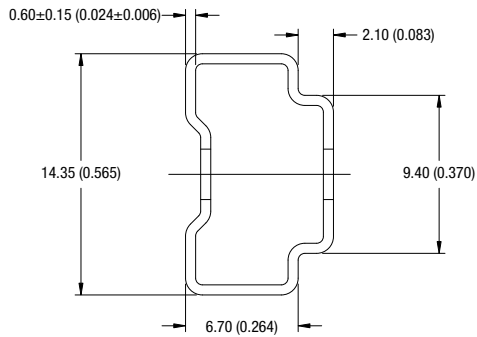

CRE1S0505MEC

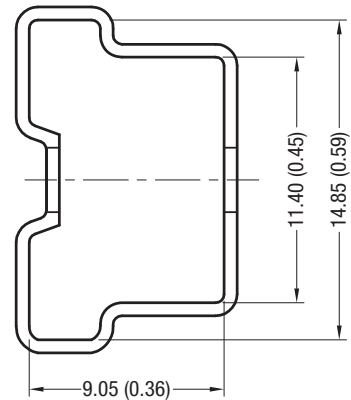

Unless otherwise specified all dimensions in mm [inches] $\pm 0.55\text{mm}$ [0.022].
 Tube Length (MC&MEC) : 475 ± 2.0 (18.70 ± 0.07).

Tube Quantity (MC): 35
 (MEC): 30

TAPE & REEL SPECIFICATIONS

REEL OUTLINE DIMENSIONS

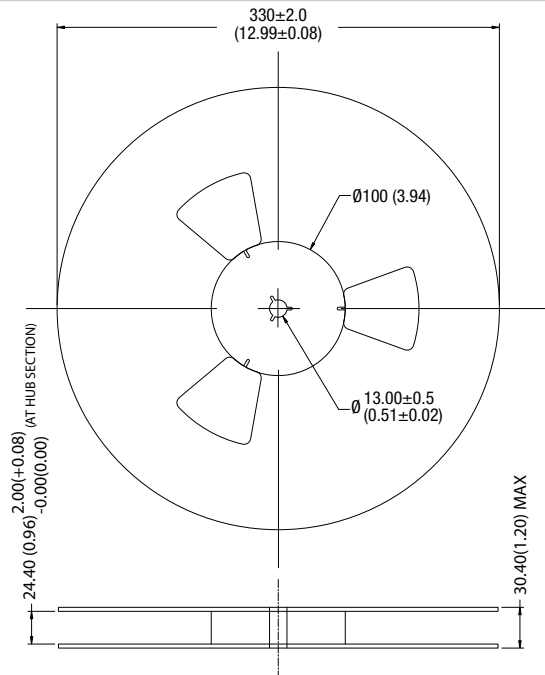

TAPE OUTLINE DIMENSIONS

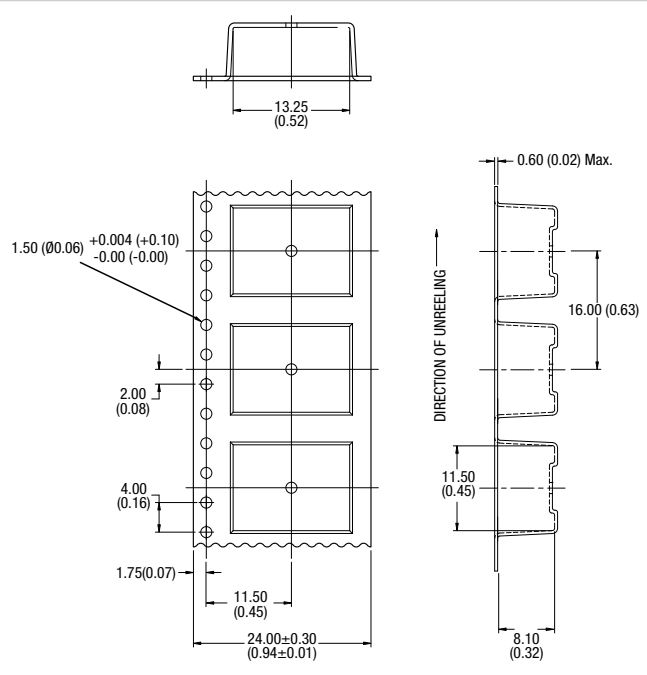

REEL PACKAGING DETAILS

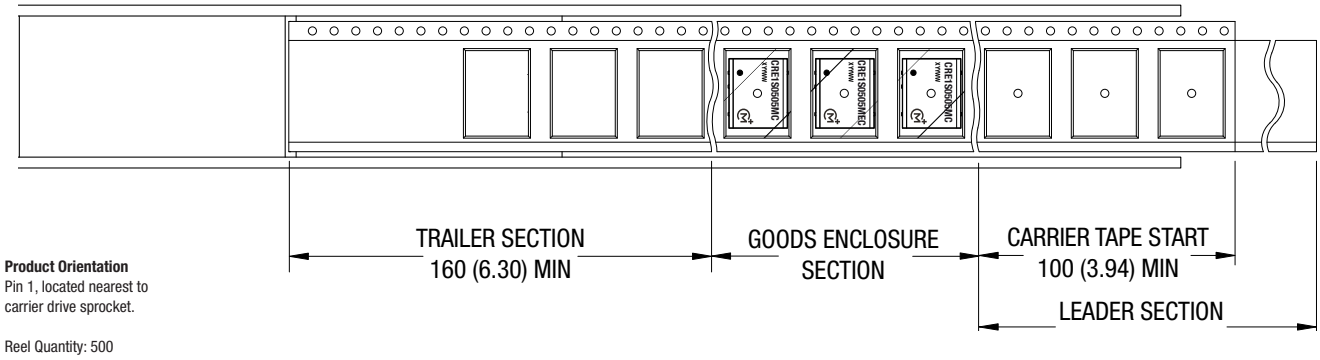

This product is subject to the following [operating requirements](#) and the [Life and Safety Critical Application Sales Policy](#):
Refer to: <http://www.murata-ps.com/requirements/>

Murata Power Solutions, Inc. makes no representation that the use of its products in the circuits described herein, or the use of other technical information contained herein, will not infringe upon existing or future patent rights. The descriptions contained herein do not imply the granting of licenses to make, use, or sell equipment constructed in accordance therewith. Specifications are subject to change without notice. © 2018 Murata Power Solutions, Inc.

Mouser Electronics

Authorized Distributor

Click to View Pricing, Inventory, Delivery & Lifecycle Information:

[Murata:](#)

[CRE1S0505S3C](#) [CRE1S2405SC](#) [CRE1S0305S3C](#) [CRE1S1212SC](#) [CRE1S0505SC](#) [CRE1S0505DC](#)
[CRE1S0515SC](#) [CRE1S2412SC](#) [CRE1S1205SC](#)



Компания «ЭлектроПласт» предлагает заключение долгосрочных отношений при поставках импортных электронных компонентов на взаимовыгодных условиях!

Наши преимущества:

- Оперативные поставки широкого спектра электронных компонентов отечественного и импортного производства напрямую от производителей и с крупнейших мировых складов;
- Поставка более 17-ти миллионов наименований электронных компонентов;
- Поставка сложных, дефицитных, либо снятых с производства позиций;
- Оперативные сроки поставки под заказ (от 5 рабочих дней);
- Экспресс доставка в любую точку России;
- Техническая поддержка проекта, помощь в подборе аналогов, поставка прототипов;
- Система менеджмента качества сертифицирована по Международному стандарту ISO 9001;
- Лицензия ФСБ на осуществление работ с использованием сведений, составляющих государственную тайну;
- Поставка специализированных компонентов (Xilinx, Altera, Analog Devices, Intersil, Interpoint, Microsemi, Aeroflex, Peregrine, Syfer, Eurofarad, Texas Instrument, Miteq, Cobham, E2V, MA-COM, Hittite, Mini-Circuits, General Dynamics и др.);

Помимо этого, одним из направлений компании «ЭлектроПласт» является направление «Источники питания». Мы предлагаем Вам помощь Конструкторского отдела:

- Подбор оптимального решения, техническое обоснование при выборе компонента;
- Подбор аналогов;
- Консультации по применению компонента;
- Поставка образцов и прототипов;
- Техническая поддержка проекта;
- Защита от снятия компонента с производства.



Как с нами связаться

Телефон: 8 (812) 309 58 32 (многоканальный)

Факс: 8 (812) 320-02-42

Электронная почта: org@eplast1.ru

Адрес: 198099, г. Санкт-Петербург, ул. Калинина, дом 2, корпус 4, литера А.