

RoHS Compliant

Serial ATA Flash Drive

SM210-300 Product Specifications (Toshiba 15nm)

February 23, 2017

Version 1.3



Apacer Technology Inc.

1F, No.32, Zhongcheng Rd., Tucheng Dist., New Taipei City, Taiwan, R.O.C

Tel: +886-2-2267-8000 Fax: +886-2-2267-2261

www.apacer.com

Features:

- **Compliance with SATA Revision 3.1**
 - SATA 6.0 Gbps interface
 - Backward compatible with SATA 1.5 and 3.0 Gbps interfaces
 - ATA-8 command set
- **Capacity**
 - 8, 16, 32, 64, 128, 256, 512 GB
- **Performance***
 - Burst read/write: 600 MB/sec
 - Sustained read: up to 505 MB/sec
 - Sustained write: up to 360 MB/sec
 - Random read 4K: up to 83,000 IOPS
 - Random write 4K: up to 79,000 IOPS
- **Flash Management**
 - Built-in hardware ECC
 - Global Wear Leveling
 - Flash bad-block management
 - Flash Translation Layer: Page Mapping
 - S.M.A.R.T.
 - Power Failure Management
 - ATA Secure Erase
 - TRIM
- **NAND Flash Type: MLC**
- **MTBF: >1,000,000 hours**
- **Endurance (in Terabytes Written: TBW)**
 - 8 GB: 14 TBW
 - 16 GB: 27 TBW
 - 32 GB: 61 TBW
 - 64 GB: 129 TBW
 - 128 GB: 277 TBW
 - 256 GB: 587 TBW
 - 512 GB: 1,035 TBW
- **Temperature Range**
 - Operating:
 - Standard: 0°C to 70°C
 - Extended: -40°C to 85°C
 - Storage: -40°C to 100°C
- **Supply Voltage**
 - 3.3 V \pm 5%
- **Power Consumption***
 - Active mode: 825 mA
 - Idle mode: 95 mA
- **Form Factor**
 - JEDEC MO-300
- **Shock & Vibration****
 - Shock: 1,500 G
 - Vibration: 15 G
- **DRAM Cache for Enhanced Random Performance**
- **SATA Power Management Modes**
- **Device Sleep Mode**
- **Write Protect Switch (optional)**
- **Thermal Sensor**
 - Standard temperature: Optional
 - Extended temperature: Default
- **LED Indicators for Drive Behavior**
- **RoHS Compliant**

*Varies from capacities. The values addressed here are typical and may vary depending on settings and platforms.

**Non-operating

Table of Contents

| | |
|--------------------------------------------------|-----------|
| 1. Product Description | 3 |
| 1.1 Introduction | 3 |
| 1.2 Capacity Specifications | 3 |
| 1.3 Performance | 3 |
| 1.4 Pin Assignments | 4 |
| 1.5 LED Indicator Behavior..... | 6 |
| 2. Software Interface | 7 |
| 2.1 Command Set..... | 7 |
| 2.2 S.M.A.R.T..... | 7 |
| 3. Flash Management | 9 |
| 3.1 Error Correction/Detection | 9 |
| 3.2 Bad Block Management | 9 |
| 3.3 Global Wear Leveling..... | 9 |
| 3.4 Power Failure Management..... | 9 |
| 3.5 ATA Secure Erase..... | 9 |
| 3.6 TRIM | 10 |
| 3.7 Flash Translation Layer – Page Mapping | 10 |
| 3.8 DEVSLP (DevSleep or DEVSLP) Mode | 10 |
| 3.9 Thermal Sensor | 10 |
| 3.10 SATA Power Management | 11 |
| 4. Reliability Specifications | 12 |
| 4.1 Environmental | 12 |
| 4.2 Mean Time Between Failures (MTBF) | 12 |
| 4.3 Certification and Compliance..... | 12 |
| 4.4 Endurance | 12 |
| 5. Electrical Characteristics | 13 |
| 5.1 Operating Voltage..... | 13 |
| 5.2 Power Consumption | 13 |
| 6. Mechanical Specifications | 14 |
| 6.1 Dimensions | 14 |
| 6.2 Write Protect Switch (optional)..... | 15 |
| 7. Product Ordering Information | 16 |
| 7.1 Product Code Designations | 16 |
| 7.2 Valid Combinations | 17 |

1. Product Description

1.1 Introduction

Apacer SM210-300 is a well-balanced solid-state disk (SSD) drive with compact form factor (JEDEC MO-300) and great performance. Designed in SATA 6.0 Gbps interface, the mSATA SSD is able to deliver exceptional read/write speed, making it the ideal companion for heavy-loading embedded or server operations with space constraints for host computing systems. For data efficiency, the internal controlling unit of the mSATA SSD is engineered with DRAM for enhanced random performance. In regard of reliability, the drive comes with various implementations including powerful hardware ECC engine, power saving modes, wear leveling, flash block management, S.M.A.R.T., TRIM, and power failure management.

1.2 Capacity Specifications

Table 1-1 Capacity Specifications

| Capacity | Total Bytes | Cylinders | Heads | Sectors | Max LBA |
|----------|-----------------|-----------|-------|---------|---------------|
| 8 GB | 8,012,390,400 | 15525 | 16 | 63 | 15,649,200 |
| 16 GB | 16,013,942,784 | 16,383 | 16 | 63 | 31,277,232 |
| 32 GB | 32,017,047,552 | 16,383 | 16 | 63 | 62,533,296 |
| 64 GB | 64,023,257,088 | 16,383 | 16 | 63 | 125,045,424 |
| 128 GB | 128,035,676,160 | 16,383 | 16 | 63 | 250,069,680 |
| 256 GB | 256,060,514,304 | 16,383 | 16 | 63 | 500,118,192 |
| 512 GB | 512,110,190,592 | 16,383 | 16 | 63 | 1,000,215,216 |

1. Display of total bytes varies from file systems.
2. Cylinders, heads or sectors are not applicable for these capacities. Only LBA addressing applies.
3. LBA count addressed in the table above indicates total user storage capacity and will remain the same throughout the lifespan of the device. However, the total usable capacity of the SSD is most likely to be less than the total physical capacity because a small portion of the capacity is reserved for device maintenance usages.

1.3 Performance

Table 1-2 Performance

| Capacity Performance | 8 GB | 16 GB | 32 GB | 64 GB | 128 GB | 256 GB | 512 GB |
|-------------------------------|--------|--------|--------|--------|--------|--------|--------|
| Sustained Read (MB/s) | 120 | 215 | 375 | 390 | 505 | 505 | 495 |
| Sustained Write (MB/s) | 25 | 50 | 100 | 90 | 175 | 345 | 360 |
| Random Read IOPS (4K) | 15,000 | 26,000 | 46,000 | 45,000 | 77,000 | 83,000 | 80,000 |
| Random Write IOPS (4K) | 4,000 | 10,000 | 24,000 | 22,000 | 43,000 | 79,000 | 69,000 |

Note: Performance varies from flash configurations or host system settings.
IOPS: measured on 8GB span (16777216 sectors Disk Size), 32 Outstanding I/Os (QD=32), Full Random Data pattern, 4KB Align I/Os and test durations 15minutes.

1.4 Pin Assignments

Pin assignment of the SM210-300 is shown in Figure 1-1 and described in Table 1-3.

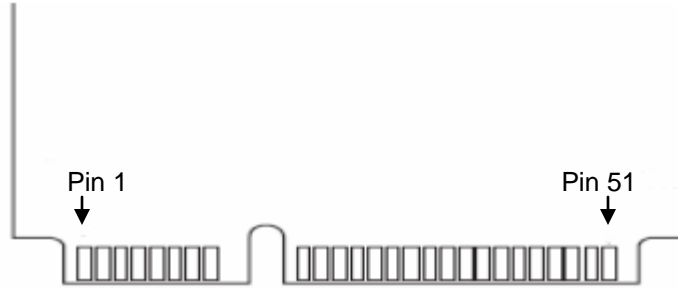
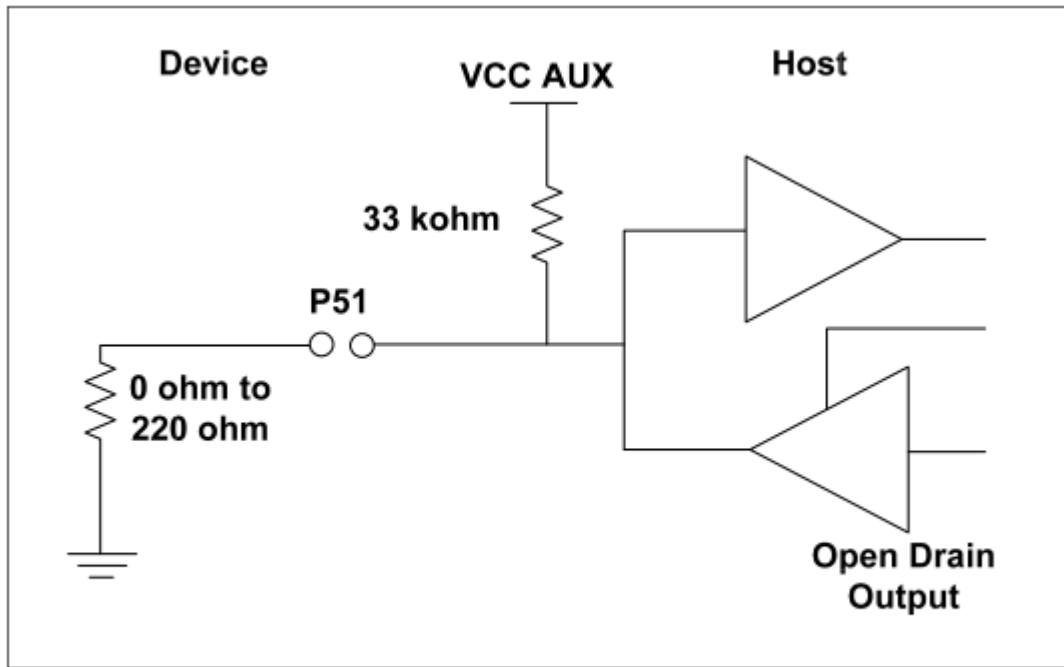

Figure 1-1 Pin Assignment

Table 1-3 Pin Assignment Description

| Pin | Type | Description | Pin | Type | Description |
|-----|----------|-------------------------------------------|-----|-------------|--------------------------------------------------------|
| 1 | Reserved | No Connect | 27 | GND | Ground |
| 2 | +3.3V | 3.3V source | 28 | Reserved | No Connect |
| 3 | Reserved | No Connect | 29 | GND | Ground |
| 4 | GND | Ground | 30 | Reserved | No Connect |
| 5 | Reserved | No Connect | 31 | -A | Host Transmitter Differential Signal Pair |
| 6 | Reserved | No Connect | 32 | Reserved | No Connect |
| 7 | Reserved | No Connect | 33 | +A | Host Transmitter Differential Signal Pair |
| 8 | Reserved | No Connect | 34 | GND | Ground |
| 9 | GND | Ground | 35 | GND | Ground |
| 10 | Reserved | No Connect | 36 | Reserved | No Connect |
| 11 | Reserved | No Connect | 37 | GND | Ground |
| 12 | Reserved | No Connect | 38 | Reserved | No Connect |
| 13 | Reserved | No Connect | 39 | +3.3V | 3.3V source |
| 14 | Reserved | No Connect | 40 | GND | Ground |
| 15 | GND | Ground | 41 | +3.3V | 3.3V source |
| 16 | Reserved | No Connect | 42 | Reserved | No Connect |
| 17 | Reserved | No Connect | 43 | Device Type | No Connect |
| 18 | GND | Ground | 44 | DEVSLP | Device Sleep |
| 19 | Reserved | No Connect | 45 | Reserved | No Connect |
| 20 | Reserved | No Connect | 46 | Reserved | No Connect |
| 21 | GND | Ground | 47 | Reserved | No Connect |
| 22 | Reserved | No Connect | 48 | Reserved | No Connect |
| 23 | +B | Host Receiver Differential Signal Pair | 49 | DAS/DSS | Device Activity Signal/Disable Staggered Spin-up |
| 24 | +3.3V | 3.3V Source | 50 | GND | Ground |
| 25 | -B | Host Receiver Differential Signal Pair | 51* | Detect | 0 ohm |
| 26 | GND | Ground | 52 | +3.3V | 3.3V source |

*Notes about Pin51: It is a presence detection pin that shall be connected to GND by a 0 ohm to 220 ohm Resistor on device. Please see the diagram below.



BI-directional host-side implementation of P51 for compatibility with non-mSATA devices (Informative)

1.5 LED Indicator Behavior

The behavior of the SS210-300 LED indicators is described in Table 1-4.

Table 1-4 LED Behavior

| Location | Status | Description |
|----------|----------|----------------------------------------------------------------------------------|
| LED A | Blinking | Accessing drive |
| | Static | Write Protect is enabled (only available for models supporting write protection) |
| LED B | Static | PHY is connected |

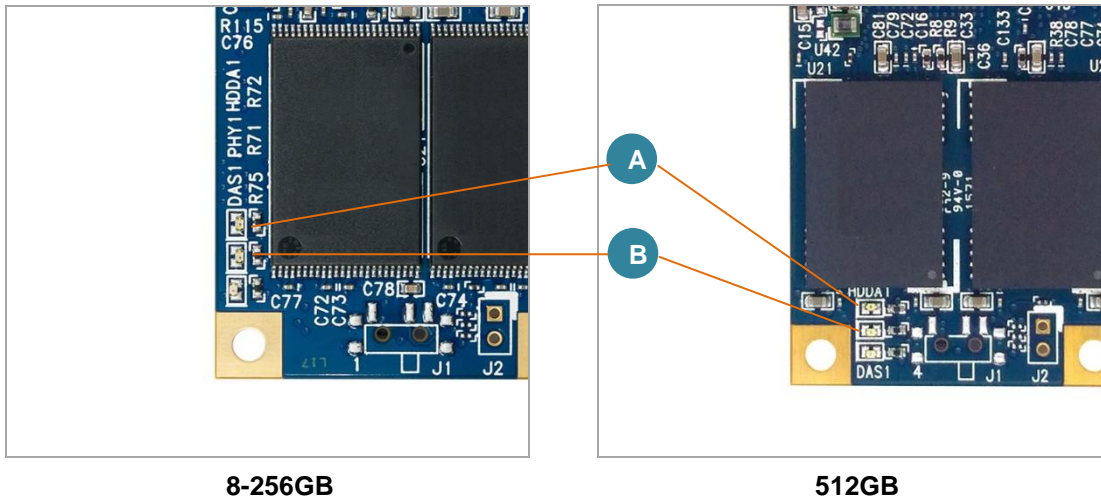

2. Software Interface

2.1 Command Set

Table 2-1 summarizes the ATA commands supported by SM210-300.

Table 2-1 Command Set

| Code | Command | Code | Command |
|-----------|------------------------------|------------|---------------------------|
| E5h | Check Power Mode | F6h | Security Disable Password |
| 90h | Execute Diagnostics | F3h | Security Erase Prepare |
| E7h | Flush Cache | F4h | Security Erase Unit |
| ECh | Identify Device | F5h | Security Freeze Lock |
| E3h | Idle | F1h | Security Set Password |
| E1h | Idle Immediate | F2h | Security Unlock |
| 91h | Initialize Device Parameters | 7Xh | Seek |
| C8h | Read DMA | EFh | Set Features |
| 25h | Read DMA EXT | C6h | Set Multiple Mode |
| 60h | Read FPDMA Queued | E6h | Sleep |
| 47h | Read Log DMA EXT | B0h | S.M.A.R.T. |
| 2Fh | Read Log EXT | E2h | Standby |
| C4h | Read Multiple | E0h | Standby Immediate |
| 20 or 21h | Read Sector(s) | CAh | Write DMA |
| 40 or 41h | Read Verify Sector(s) | 35h | Write DMA EXT |
| 10h | Recalibrate | 61h | Write FPDMA Queued |
| 57h | Write Log DMA EXT | 3Fh | Write Log EXT |
| C5h | Write Multiple | 30h or 31h | Write Sector(s) |

2.2 S.M.A.R.T.

S.M.A.R.T. is an abbreviation for Self-Monitoring, Analysis and Reporting Technology, a self-monitoring system that provides indicators of drive health as well as potential disk problems. It serves as a warning for users from unscheduled downtime by monitoring and displaying critical drive information. Ideally, this should allow taking proactive actions to prevent drive failure and make use of S.M.A.R.T. information for future product development reference.

Apacer devices use the standard SMART command B0h to read data out from the drive to activate our S.M.A.R.T. feature that complies with the ATA/ATAPI specifications. S.M.A.R.T. Attribute IDs shall include initial bad block count, total later bad block count, maximum erase count, average erase count, power on hours and power cycle. When the S.M.A.R.T. Utility running on the host, it analyzes and reports the disk status to the host before the device reaches in critical condition.

Note: Attribute IDs may vary from product models due to various solution design and supporting capabilities.

Serial ATA Flash Drive APMxxxGMFXX-XXTM1XX

Apacer memory products come with S.M.A.R.T. commands and subcommands for users to obtain information of drive status and to predict potential drive failures. Users can take advantage of the following commands/subcommands to monitor the health of the drive.

| Code | SMART Subcommand |
|------|-----------------------------------|
| D0h | READ DATA |
| D1h | READ ATTRIBUTE THRESHOLDS |
| D2h | Enable/Disable Attribute Autosave |
| D4h | Execute Off-line Immediate |
| D5h | Read Log (optional) |
| D6h | Write Log (optional) |
| D8h | Enable Operations |
| D9h | Disable operations |
| DAh | Return Status |

General SMART attribute structure

| Byte | Description |
|-------|-------------|
| 0 | ID (Hex) |
| 1 – 2 | Status flag |
| 3 | Value |
| 4 | Worst |
| 5*-11 | Raw Data |

*Byte 5: LSB

SMART attribute ID list

| ID (Hex) | Attribute Name |
|------------|------------------------------------|
| 9 (0x09) | Power-on hours |
| 12 (0x0C) | Power cycle count |
| 163 (0xA3) | Max. erase count |
| 164 (0xA4) | Avg. erase count |
| 166 (0xA6) | Total later bad block count |
| 167 (0xA7) | SSD Protect Mode (vendor specific) |
| 168 (0xA8) | SATA PHY Error Count |
| 175 (0xAF) | Bad Cluster Table Count |
| 192 (0xC0) | Unexpected Power Loss Count |
| 194 (0xC2) | Temperature |
| 241 (0xF1) | Total sectors of write |

3. Flash Management

3.1 Error Correction/Detection

SM210-300 implements a hardware ECC scheme, based on the BCH algorithm. It can detect and correct up to 40 bits error in 1K bytes.

3.2 Bad Block Management

Current production technology is unable to guarantee total reliability of NAND flash memory array. When a flash memory device leaves factory, it comes with a minimal number of initial bad blocks during production or out-of-factory as there is no currently known technology that produce flash chips free of bad blocks. In addition, bad blocks may develop during program/erase cycles. When host performs program/erase command on a block, bad block may appear in Status Register. Since bad blocks are inevitable, the solution is to keep them in control. Apacer flash devices are programmed with ECC, block mapping technique and S.M.A.R.T to reduce invalidity or error. Once bad blocks are detected, data in those blocks will be transferred to free blocks and error will be corrected by designated algorithms.

3.3 Global Wear Leveling

Flash memory devices differ from Hard Disk Drives (HDDs) in terms of how blocks are utilized. For HDDs, when a change is made to stored data, like erase or update, the controller mechanism on HDDs will perform overwrites on blocks. Unlike HDDs, flash blocks cannot be overwritten and each P/E cycle wears down the lifespan of blocks gradually. Repeatedly program/erase cycles performed on the same memory cells will eventually cause some blocks to age faster than others. This would bring flash storages to their end of service term sooner. Global wear leveling is an important mechanism that levels out the wearing of all blocks so that the wearing-down of all blocks can be almost evenly distributed. This will increase the lifespan of SSDs.

3.4 Power Failure Management

Power Failure Management plays a crucial role when experiencing unstable power supply. Power disruption may occur when users are storing data into the SSD. In this urgent situation, the controller would run multiple write-to-flash cycles to store the metadata for later block rebuilding. This urgent operation requires about several milliseconds to get it done. At the next power up, the firmware will perform a status tracking to retrieve the mapping table and resume previously programmed NAND blocks to check if there is any incompleteness of transmission.

Note: The controller unit of this product model is designed with a DRAM as a write cache for improved performance and data efficiency. Though unlikely to happen in most cases, the data cached in the volatile DRAM might be potentially affected if a sudden power loss takes place before the cached data is flushed into non-volatile NAND flash memory.

3.5 ATA Secure Erase

ATA Secure Erase is an ATA disk purging command currently embedded in most of the storage drives. Defined in ATA specifications, (ATA) Secure Erase is part of Security Feature Set that allows storage drives to erase all user data areas. The erase process usually runs on the firmware level as most of the ATA-based storage media currently in the market are built-in with this command. ATA Secure Erase can securely wipe out the user data in the drive and protects it from malicious attack.

3.6 TRIM

TRIM is a SATA command that helps improve the read/write performance and efficiency of solid-state drives (SSD). The command enables the host operating system to inform SSD controller which blocks contain invalid data, mostly because of the erase commands from host. The invalid will be discarded permanently and the SSD will retain more space for itself.

3.7 Flash Translation Layer – Page Mapping

Page mapping is a 4K-based firmware technology whose essence lies in the ability to gather data, distribute the data into 4KB blocks automatically, and then schedule the data to be evenly written. This implementation is also evidenced by JEDEC that 4KB is the most frequently used block size for data read/write access, constituting 67% of server workload. Thus, 4K page mapping is adopted to increase random access speed and improve SSD lifespan, reduce block erase frequency, and achieve optimized performance and lifespan.

3.8 DEVSLP (DevSleep or DEVSLP) Mode

Device Sleep is a feature that allows SATA devices to enter a low power mode by designating pin 44 as DEVSLP signal with an aim to reducing power consumption.

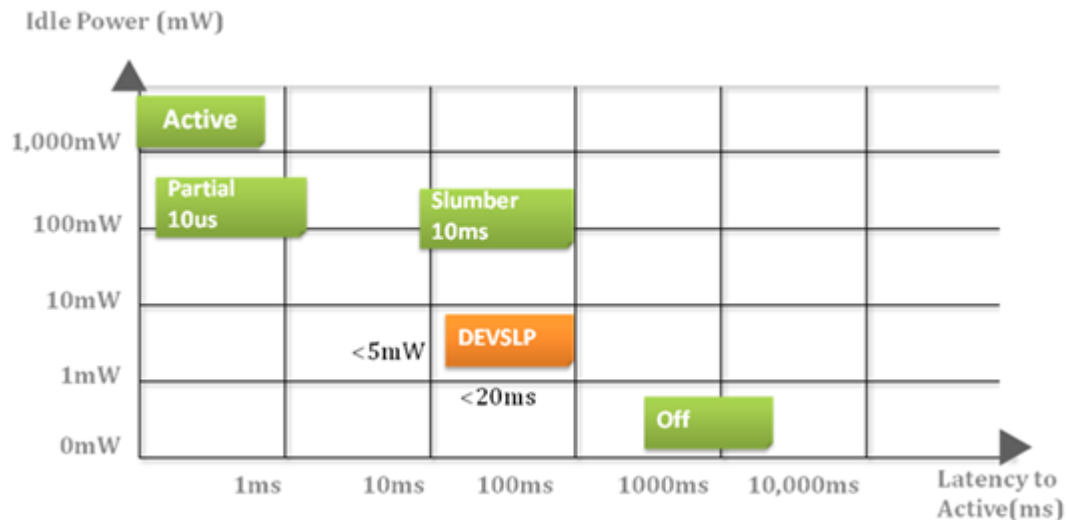

3.9 Thermal Sensor

Apacer Thermal Sensor is a digital temperature sensor with serial interface. By using designated pins for transmission, storage device owners are able to read temperature data.

3.10 SATA Power Management

By complying with SATA 6.0 Gb/s specifications, the SSD supports the following SATA power saving modes:

- ACTIVE: PHY ready, full power, Tx & Rx operational
- PARTIAL: Reduces power, resumes in under 10 μ s (microseconds)
- SLUMBER: Reduces power, resumes in under 10 ms (milliseconds)
- HIPM: Host-Initiated Power Management
- DIPM: Device-Initiated Power Management
- AUTO-SLUMBER: Automatic transition from partial to slumber.
- Device Sleep (DevSleep or DEVSLP): PHY powered down; power consumption \leq 5 mW; host assertion time \leq 10 ms; exit timeout from this state \leq 20 ms (unless specified otherwise in SATA Identify Device Log).

Note: The behaviors of power management features would depend on host/device settings.

4. Reliability Specifications

4.1 Environmental

SM210-300 environmental specifications follow MIL-STD-810F, as indicated in the following table.

Table 4-1 Environmental Specifications

| Environment | Specifications |
|-------------|---------------------------------------------------------------------------------------------|
| Temperature | 0°C to 70°C (Standard); -40°C to 85°C (Extended) |
| | -40°C to 100°C (Non-operating) |
| Vibration | Non-operating: Sine wave, 15(G), 10~2000(Hz), Operating: Random, 7.69(Grms), 20~2000(Hz) |
| Shock | Non-operating: Acceleration, 1,500 G, 0.5 ms Operating: Peak acceleration, 50 G, 11 ms |

4.2 Mean Time Between Failures (MTBF)

Mean Time Between Failures (MTBF) is predicted based on reliability data for the individual components in SATA drive. The prediction result for the SM210-300 is more than 1,000,000 hours.

Note: the MTBF is predicated and calculated based on “Telcordia Technologies Special Report, SR-332, Issue 2” method.

4.3 Certification and Compliance

SM210-300 complies with the following standards:

- CE
- FCC
- RoHS
- MIL-STD-810F

4.4 Endurance

The endurance of a storage device is predicted by TeraBytes Written based on several factors related to usage, such as the amount of data written into the drive, block management conditions, and daily workload for the drive. Thus, key factors, such as Write Amplifications and the number of P/E cycles, can influence the lifespan of the drive.

| Capacity | TeraBytes Written |
|----------|-------------------|
| 8 GB | 14 |
| 16 GB | 27 |
| 32 GB | 61 |
| 64 GB | 129 |
| 128 GB | 277 |
| 256 GB | 587 |
| 512 GB | 1,035 |

Note:

- The measurement assumes the data written to the SSD for test is under a typical and constant rate.
- The measurement follows the standard metric: 1 TB (Terabyte) = 1,000 GB.
- The estimated values are based on JEDEC Enterprise endurance workload comprised of random data with the payload size distribution with sequential write behavior.

5. Electrical Characteristics

5.1 Operating Voltage

Table 5-1 lists the supply voltage for SM210-300.

Table 5-1 Operating Voltage

| Parameter | Conditions |
|----------------|------------|
| Supply Voltage | 3.3V ± 5% |

5.2 Power Consumption

Table 5-2 lists the power consumption for SM210-300.

Table 5-2 Typical Power Consumption

| Capacity Modes | 8 GB | 16 GB | 32 GB | 64 GB | 128 GB | 256 GB | 512 GB |
|--------------------|------|-------|-------|-------|--------|--------|--------|
| Active (mA) | 235 | 270 | 320 | 335 | 460 | 710 | 825 |
| Idle (mA) | 90 | 90 | 90 | 95 | 95 | 95 | 80 |

Note: Results may differ from various flash configurations or host system setting.

6. Mechanical Specifications

6.1 Dimensions

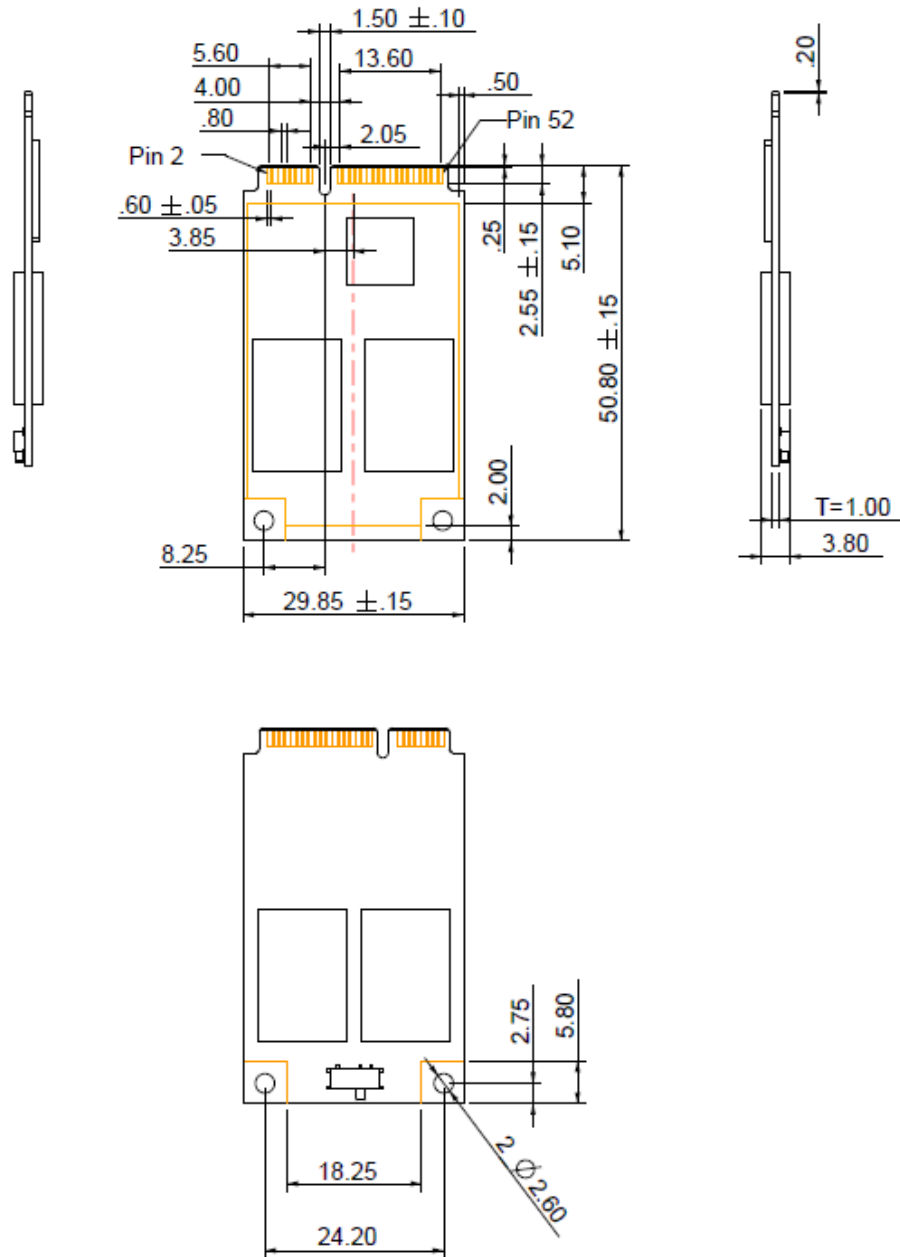

Unit: mm
Tolerance: ± 0.2

6.2 Write Protect Switch (optional)

Apacer implements the Virtual Write scheme that allows write commands to go through the flash controller and data temporarily stored, but no data has been actually written into the flash. Once the system is reset and rebooted, the temporarily stored data will be lost and nowhere to be found in the system. Since the Virtual Write scheme runs at device level, it requires no software or driver installation and is independent from the host OS.

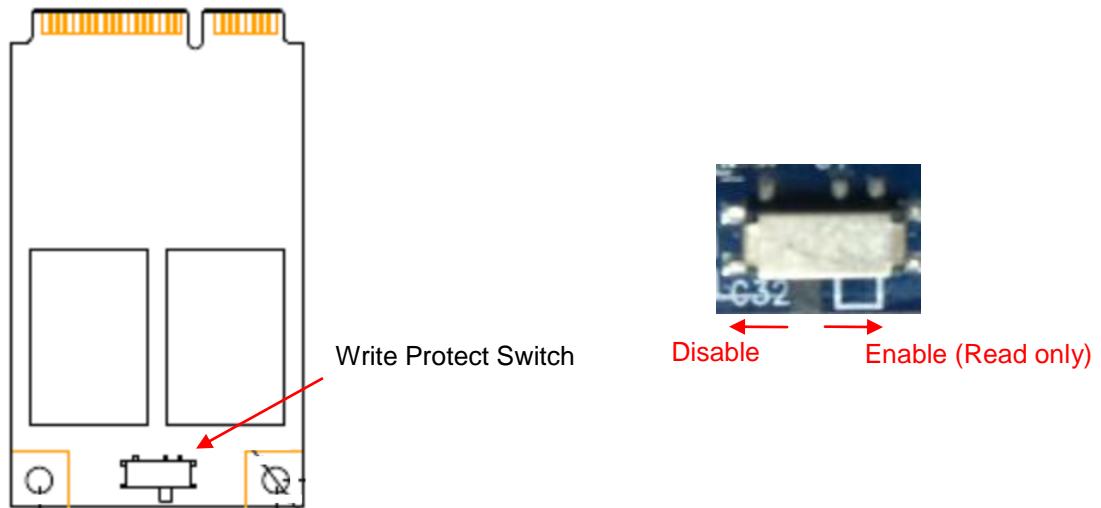

Note: Write Protect is optional and the image is for reference only.

7. Product Ordering Information

7.1 Product Code Designations

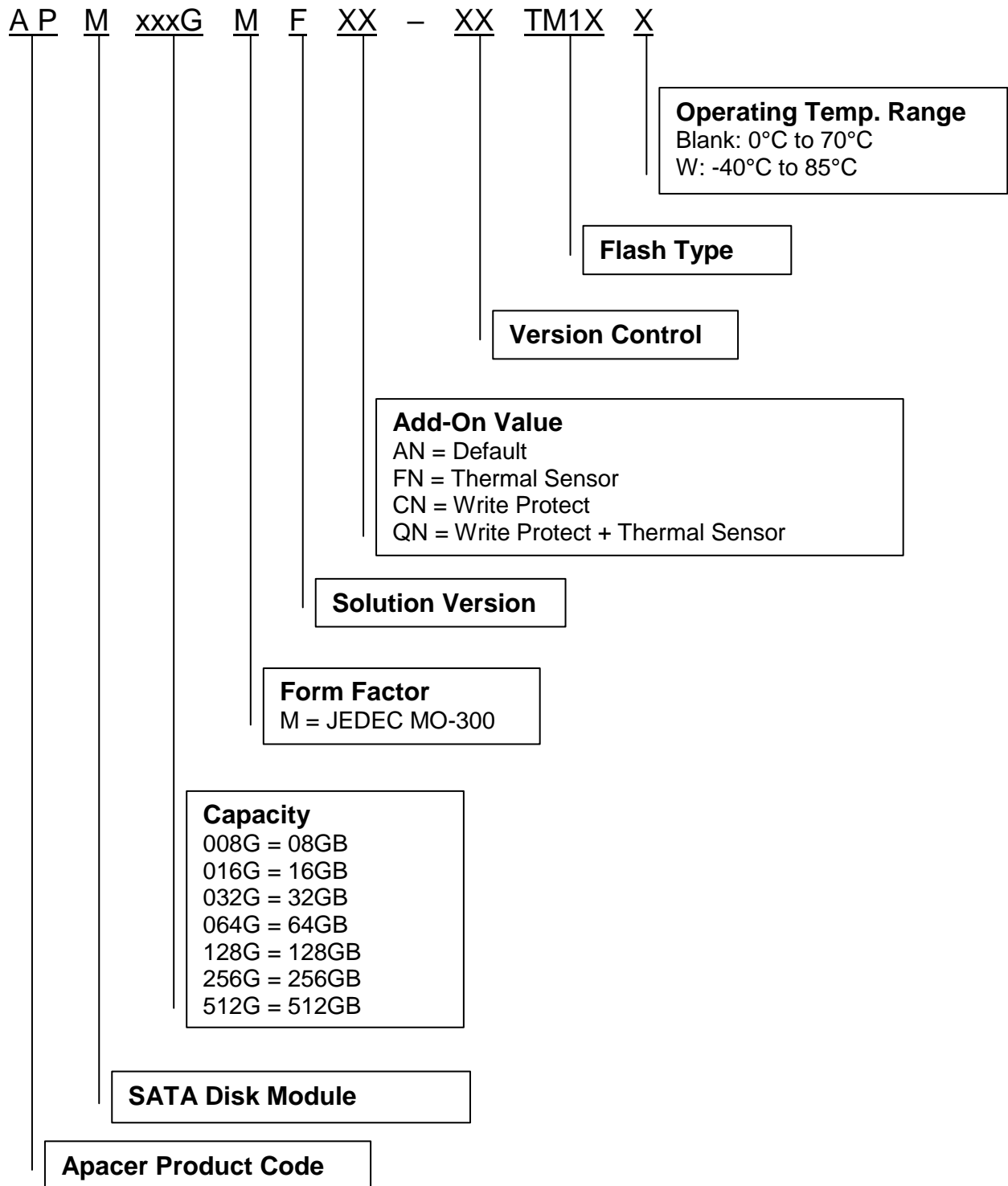

7.2 Valid Combinations*

7.2.1 Default

| Capacity | Standard Temperature | Extended Temperature** |
|----------|----------------------|------------------------|
| 8GB | APM008GMFAN-3BTM1 | APM008GMFFN-3BTM1W |
| 16GB | APM016GMFAN-3BTM1 | APM016GMFFN-3BTM1W |
| 32GB | APM032GMFAN-3BTM1 | APM032GMFFN-3BTM1W |
| 64GB | APM064GMFAN-3BTM1 | APM064GMFFN-3BTM1W |
| 128GB | APM128GMFAN-3BTM1G | APM128GMFFN-3BTM1GW |
| 256GB | APM256GMFAN-3BTM1G | APM256GMFFN-3BTM1GW |
| 512GB | APM512GMFAN-B3TM1G | APM512GMFFN-B3TM1GW |

7.2.2 With Write Protect (optional)

| Capacity | Standard Temperature | Extended Temperature** |
|----------|----------------------|------------------------|
| 8GB | APM008GMFCN-3BTM1 | APM008GMFQN-3BTM1W |
| 16GB | APM016GMFCN-3BTM1 | APM016GMFQN-3BTM1W |
| 32GB | APM032GMFCN-3BTM1 | APM032GMFQN-3BTM1W |
| 64GB | APM064GMFCN-3BTM1 | APM064GMFQN-3BTM1W |
| 128GB | APM128GMFCN-3BTM1G | APM128GMFQN-3BTM1GW |
| 256GB | APM256GMFCN-3BTM1G | APM256GMFQN-3BTM1GW |
| 512GB | APM512GMFCN-B3TM1G | APM512GMFQN-B3TM1GW |

7.2.3 With Thermal Sensor (optional)

| Capacity | Standard Temperature |
|----------|----------------------|
| 8GB | APM008GMFFN-3BTM1 |
| 16GB | APM016GMFFN-3BTM1 |
| 32GB | APM032GMFFN-3BTM1 |
| 64GB | APM064GMFFN-3BTM1 |
| 128GB | APM128GMFFN-3BTM1G |
| 256GB | APM256GMFFN-3BTM1G |
| 512GB | APM512GMFFN-B3TM1G |

Note:

*Valid combinations are those products in mass production or will be in mass production. Consult your Apacer sales representative to confirm availability of valid combinations and to determine availability of new combinations.

**With built-in thermal sensor.

Revision History

| Revision | Description | Date |
|----------|--------------------------------------------------------------------------------------------------------------------|------------|
| 0.1 | Preliminary release | 4/26/2016 |
| 0.2 | - Updated performance, endurance, and power consumption values for 512GB - Revised product ordering information | 5/17/2016 |
| 0.3 | Revised product ordering information for the standard models with extended temperature support | 5/19/2016 |
| 0.4 | Revised product ordering information | 6/22/2016 |
| 0.5 | Revised product ordering information | 6/23/2016 |
| 0.6 | - Revised endurance rating for 512GB - Added flash management descriptions for page mapping and DEVSLP | 7/26/2016 |
| 1.0 | Updated endurance ratings | 8/31/2016 |
| 1.1 | Added 1.5 LED Indicator Behavior | 11/30/2016 |
| 1.2 | Updated product ordering information | 2/20/2017 |
| 1.3 | Changed 7.2.1 title from Standard to Default | 2/23/2017 |

Global Presence

| | |
|------------------------------|---------------------------------------------------------------------------------------------------------------------------------------------------------------------------------------------------------------------------------------------------------------------------|
| Taiwan (Headquarters) | Apacer Technology Inc. 1F., No.32, Zhongcheng Rd., Tucheng Dist., New Taipei City 236, Taiwan R.O.C. Tel: 886-2-2267-8000 Fax: 886-2-2267-2261 amtsales@apacer.com |
| U.S.A. | Apacer Memory America, Inc. 46732 Lakeview Blvd., Fremont, CA 94538 Tel: 1-408-518-8699 Fax: 1-510-249-9551 sa@apacerus.com |
| Japan | Apacer Technology Corp. 5F, Matsura Bldg., Shiba, Minato-Ku Tokyo, 105-0014, Japan Tel: 81-3-5419-2668 Fax: 81-3-5419-0018 jpservices@apacer.com |
| Europe | Apacer Technology B.V. Science Park Eindhoven 5051 5692 EB Son, The Netherlands Tel: 31-40-267-0000 Fax: 31-40-290-0686 sales@apacer.nl |
| China | Apacer Electronic (Shanghai) Co., Ltd Room D, 22/FL, No.2, Lane 600, JieyunPlaza, Tianshan RD, Shanghai, 200051, China Tel: 86-21-6228-9939 Fax: 86-21-6228-9936 sales@apacer.com.cn |
| India | Apacer Technologies Pvt Ltd, Unit No.201, "Brigade Corner", 7 th Block Jayanagar, Yediyur Circle, Bangalore – 560082, India Tel: 91-80-4152-9061 Fax: 91-80-4170-0215 sales_india@apacer.com |



Компания «ЭлектроПласт» предлагает заключение долгосрочных отношений при поставках импортных электронных компонентов на взаимовыгодных условиях!

Наши преимущества:

- Оперативные поставки широкого спектра электронных компонентов отечественного и импортного производства напрямую от производителей и с крупнейших мировых складов;
- Поставка более 17-ти миллионов наименований электронных компонентов;
- Поставка сложных, дефицитных, либо снятых с производства позиций;
- Оперативные сроки поставки под заказ (от 5 рабочих дней);
- Экспресс доставка в любую точку России;
- Техническая поддержка проекта, помощь в подборе аналогов, поставка прототипов;
- Система менеджмента качества сертифицирована по Международному стандарту ISO 9001;
- Лицензия ФСБ на осуществление работ с использованием сведений, составляющих государственную тайну;
- Поставка специализированных компонентов (Xilinx, Altera, Analog Devices, Intersil, Interpoint, Microsemi, Aeroflex, Peregrine, Syfer, Eurofarad, Texas Instrument, Miteq, Cobham, E2V, MA-COM, Hittite, Mini-Circuits, General Dynamics и др.);

Помимо этого, одним из направлений компании «ЭлектроПласт» является направление «Источники питания». Мы предлагаем Вам помощь Конструкторского отдела:

- Подбор оптимального решения, техническое обоснование при выборе компонента;
- Подбор аналогов;
- Консультации по применению компонента;
- Поставка образцов и прототипов;
- Техническая поддержка проекта;
- Защита от снятия компонента с производства.



Как с нами связаться

Телефон: 8 (812) 309 58 32 (многоканальный)

Факс: 8 (812) 320-02-42

Электронная почта: org@eplast1.ru

Адрес: 198099, г. Санкт-Петербург, ул. Калинина, дом 2, корпус 4, литера А.