



mikromedia™

for PIC32®

Compact development system rich with on-board peripherals for all-round multimedia development on PIC32MX460F512L device.



TO OUR VALUED CUSTOMERS

I want to express my thanks to you for being interested in our products and for having confidence in MikroElektronika.

The primary aim of our company is to design and produce high quality electronic products and to constantly improve the performance thereof in order to better suit your needs.

A handwritten signature in black ink, appearing to read 'Nebojsa Matic', with a stylized, cursive script.

Nebojsa Matic
General Manager

Table of contents

Introduction to mikromedia for PIC32®	4	Programming with mikroProg™ programmer	16
Package contains	5	mikroProg Suite™ for PIC® software	17
Key features	6	Programming with ICD2® or ICD3® programmer	18
System specification	7	4. Reset button	20
1. Power supply	8	5. Crystal oscillator	22
Battery power supply	8	6. microSD card slot	24
USB power supply	8	7. Touch screen	26
2. PIC32MX460F512L microcontroller	10	8. Audio module	28
Key microcontroller features	10	9. USB connection	30
3. Programming the microcontroller	11	10. Accelerometer	32
Programming with mikroBootloader	12	11. Flash memory	34
step 1 - Connecting mikromedia	12	12. Pads	36
step 2 - Browsing for .HEX file	13	13. Pinout	37
step 3 - Selecting .HEX file	13	14. Dimensions	38
step 4 - Uploading .HEX file	14	15. mikromedia accessories	39
step 5 - Finish upload	15	What's next?	40

Introduction to mikromedia for PIC32®

The **mikromedia for PIC32®** is a compact development system with lots of on-board peripherals which allow development of devices with multimedia contents. The central part of the system is a 32-bit **PIC32MX460F512L** microcontroller. The mikromedia for PIC32® features integrated modules such as stereo MP3 codec, **TFT 320x240 touch screen** display, accelerometer, USB connector, audio connector, MMC/SD card slot, 8 Mbit flash memory, 2x26 connection pads and other. It comes pre-programmed with USB HID bootloader, but can also be programmed with external programmers, such as mikroProg™ or ICD2/3. Mikromedia is compact and slim, and perfectly fits in the palm of the hand, which makes it convenient platform for mobile devices.



Package contains



01 Damage resistant protective box



02 mikromedia for dsPIC33® development system



03 User's guide, schematic and pinout



04 USB cable, two 1x26, one 1x6 and one 1x5 male headers

Key features

- 01 Connection Pads
- 02 TFT 320x240 display
- 03 USB MINI-B connector
- 04 CHARGE indication LED
- 05 LI-Polymer battery connector
- 06 3.5mm headphone connector
- 07 Power supply regulator
- 08 Serial Flash memory
- 09 RESET button
- 10 VS1053 Stereo mp3 coder/decoder
- 11 PIC32MX460F512L microcontroller
- 12 Accelerometer
- 13 Crystal oscillator
- 14 Power indication LED
- 15 microSD Card Slot
- 16 ICD2/3 connector
- 17 mikroProg connector



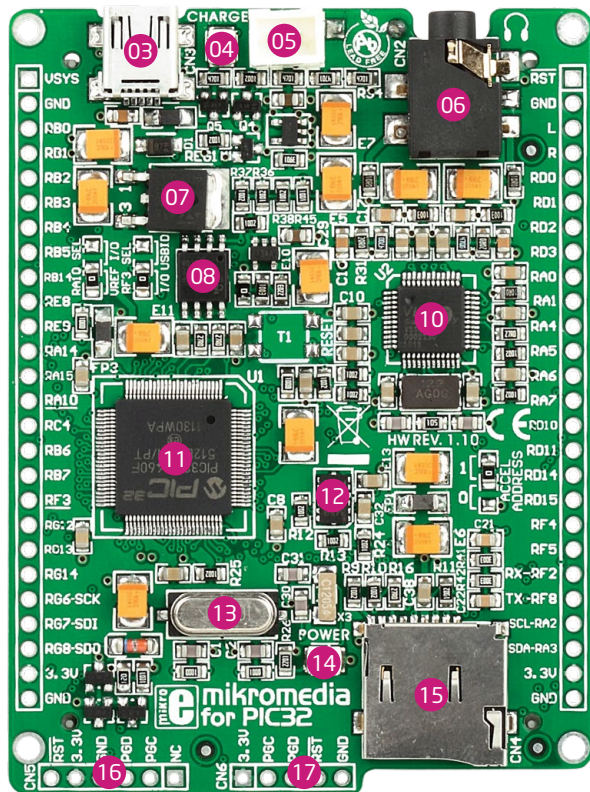

System specification



power supply

Via USB cable (5V DC)



power consumption

58 mA with erased MCU (when on-board modules are inactive)



board dimensions

81.2 x 60.5 mm (3.19 x 2.38 inch)



weight

~50g (0.11lbs)



class B product

Product complies with the Class B limit of EN 55022 and can be used in the domestic, residential, commercial and industrial environments.



CAUTION: Electrostatic Sensitive Device

Permanent damage may occur on devices subjected to high energy electrostatic discharges which readily accumulate on the human body or test equipment and can discharge without detection.

1. Power supply

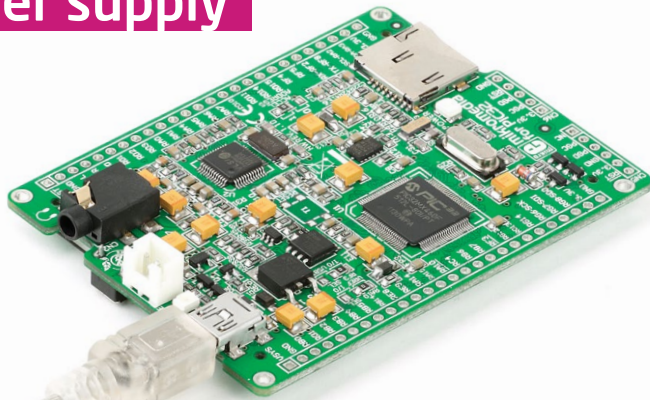

Figure 1-1:
Connecting USB
power supply

USB power supply

You can apply power supply to the board using **MINI-B USB** cable provided with the board. On-board voltage regulators provide the appropriate voltage levels to each component on the board. **Power LED (GREEN)** will indicate the presence of power supply.

Battery power supply

You can also power the board using **Li-Polymer** battery, via on-board battery connector. On-board battery charger circuit **MCP73832** enables you to charge the battery over USB connection. **LED diode (RED)** will indicate when battery is charging. Charging current is ~250mA and charging voltage is 4.2V DC.

Figure 1-2: Connecting
Li-Polymer battery

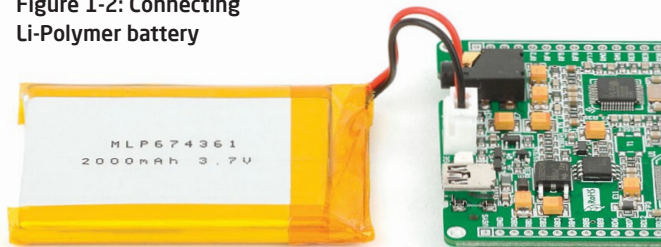

DATA BUS

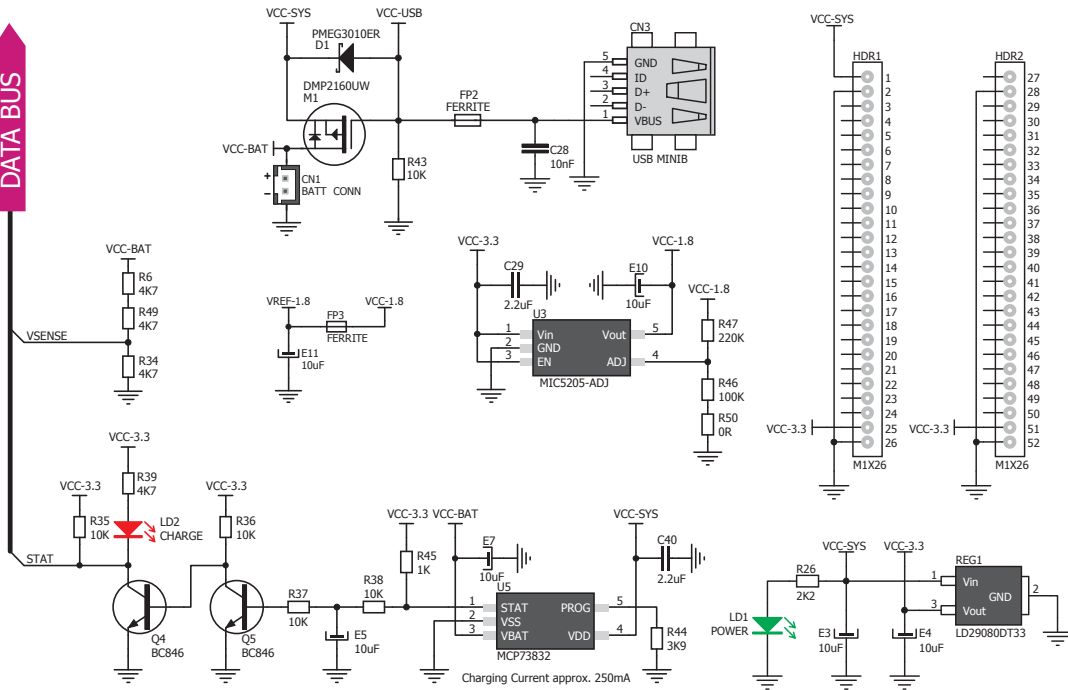

Figure 1-3: Power supply schematics

2. PIC32MX460F512L microcontroller

The **mikromedia for PIC32®** development system comes with the **PIC32MX460F512L** microcontroller. This high-performance 32-bit microcontroller with its integrated modules and in combination with other on-board modules is ideal for multimedia applications.

Key microcontroller features

- 1.56 DMIPS/MHz, 32-bit MIPS M4K Core;
- 512K Flash (plus 12K boot Flash);
- 32K RAM (can execute from RAM);
- 85 I/O pins;
- SPI, I²C, A/D;
- 16-bit, 32-bit Digital Timers;
- Internal Oscillator 8MHz, 32kHz;
- RTCC; etc.

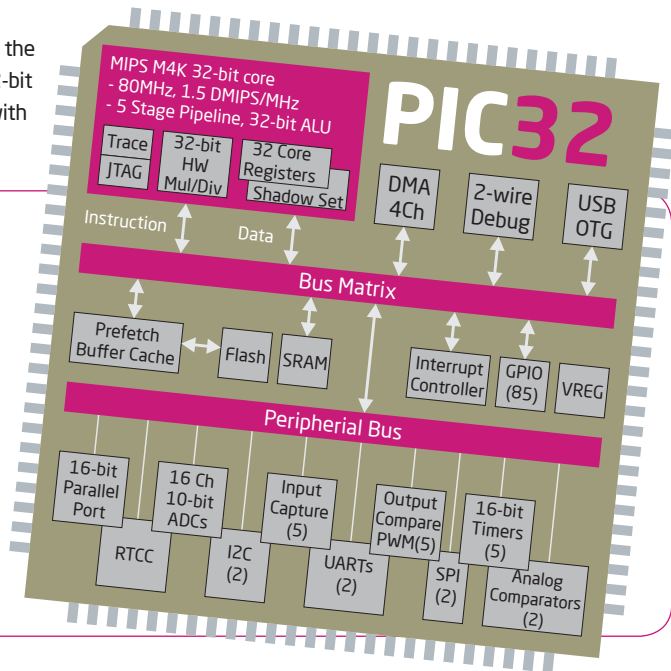

3. Programming the microcontroller

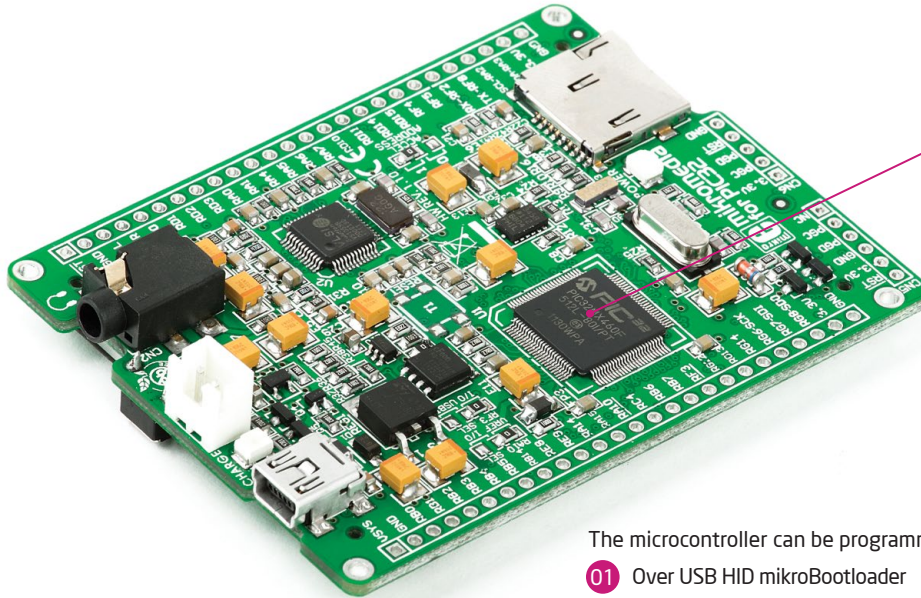

Figure 3-1:
PIC32MX460F512L
microcontroller

The microcontroller can be programmed in three ways:

- 01 Over USB HID mikroBootloader
- 02 Using mikroProg™ external programmer
- 03 Using ICD2/3 external programmer

Programming with mikroBootloader

You can program the microcontroller with bootloader which is preprogrammed into the device by default. To transfer .hex file from a PC to MCU you need bootloader software (**mikroBootloader USB HID**) which can be downloaded from:

 www.mikroe.com/downloads/get/2153/mikrobootloader_usb_hid_STM32F407VGT6.zip

Upon download, unzip it to desired location and start the mikroBootloader application:

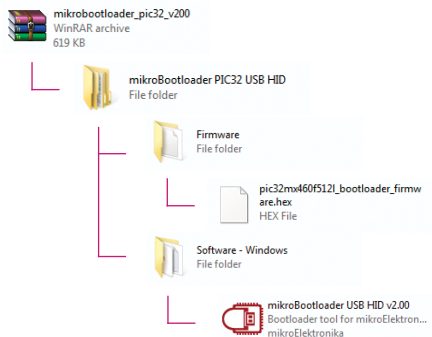

step 1 - Connecting mikromedia



Figure 3-2: USB HID mikroBootloader window

- 01** To start, connect the USB cable, or if already connected press the **Reset** button on your mikromedia board. Click the **Connect** button within 5s to enter the bootloader mode, otherwise existing microcontroller program will execute.

step 2 - Browsing for .HEX file



Figure 3-3: Browse for HEX

- 01 Click the **Browse for HEX** button and from a pop-up window (**Figure 3.4**) choose the .HEX file which will be uploaded to MCU memory.

step 3 - Selecting .HEX file

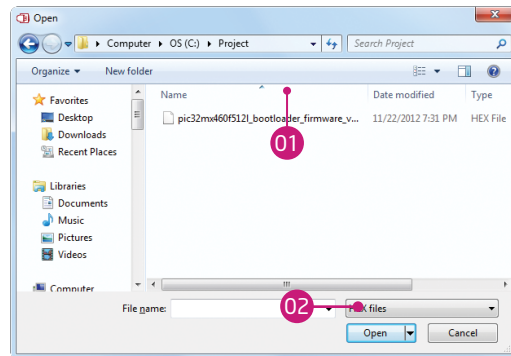

Figure 3-4: Selecting HEX

- 01 Select .HEX file using open dialog window.
- 02 Click the **Open** button.

step 4 - Uploading .HEX file



Figure 3-5: Begin uploading

01 To start .HEX file bootloading click the **Begin uploading** button.



Figure 3-6: Progress bar

01 Progress bar enables you to monitor .HEX file uploading.

step 5 - Finish upload

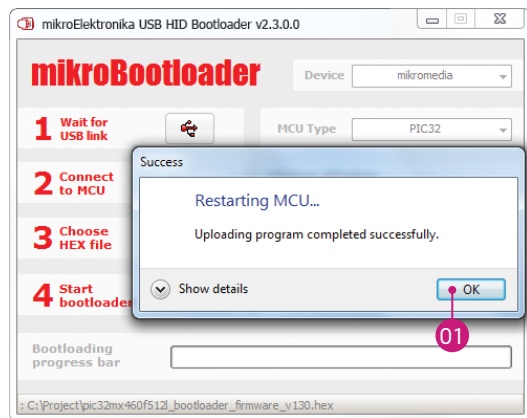

Figure 3-7: Restarting MCU

- 01 Click **OK** button after the uploading process is finished
- 02 Press **Reset** button on mikromedia board and wait for 5 seconds. Your program will run automatically



Figure 3-8: mikroBootloader ready for next job

Programming with mikroProg™ programmer

The microcontroller can be programmed with **mikroProg™ programmer** and **mikroProg Suite™ for PIC®** software. The mikroProg™ programmer is connected to the development system via the CN6 connector, **Figure 3-9**.



mikroProg™ is a fast USB 2.0 programmer with mikroCD™ hardware In-Circuit Debugger. Smart engineering allows mikroProg™ to support PIC10®, PIC12®, PIC16®, PIC18®, dsPIC30/33®, PIC24® and PIC32® devices in a single programmer. It supports over 570 microcontrollers from Microchip®. Outstanding performance, easy operation and elegant design are it's key features.

Figure 3-9:
Connecting mikroProg™ to mikroMedia™

mikroProg Suite™ for PIC® software



mikroProg™ programmer requires special programming software called **mikroProg Suite™ for PIC®**. This software is used for programming of ALL Microchip® microcontroller families, including PIC10®, PIC12®, PIC16®, PIC18®, dsPIC30/33®, PIC24® and PIC32®. Software has intuitive interface and SingleClick™ programming technology. Just by downloading the latest version of **mikroProg Suite™** your programmer is ready to program new devices. **mikroProg Suite™** is updated regularly, at least four times a year, so your programmer will be more and more powerful with each new release.

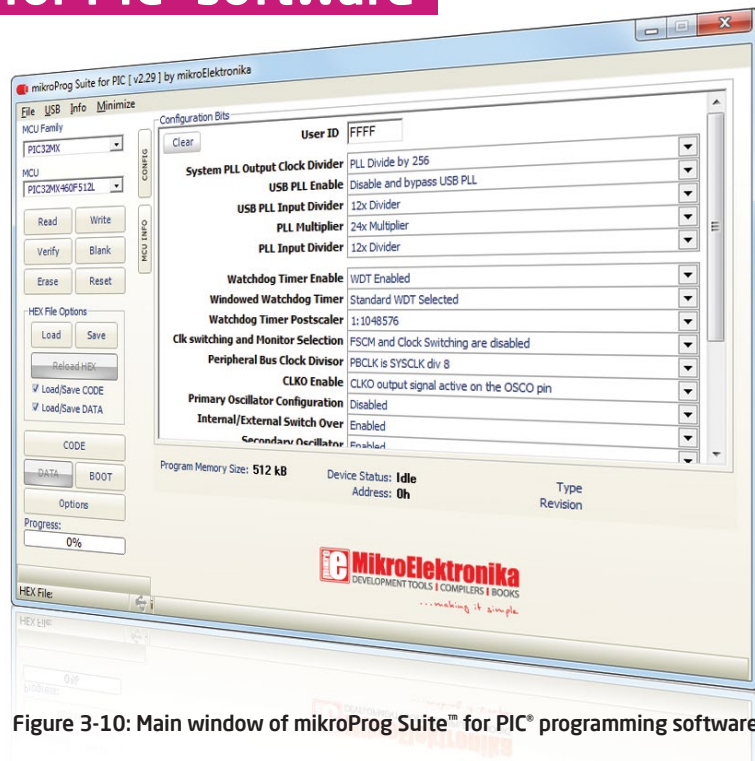

Figure 3-10: Main window of mikroProg Suite™ for PIC® programming software

Programming with ICD2[®] or ICD3[®] programmer

The microcontroller can be also programmed with **ICD2[®] or ICD3[®] programmer**. These programmers connects with mikromedia board via **ICD2 CONNECTOR BOARD**.

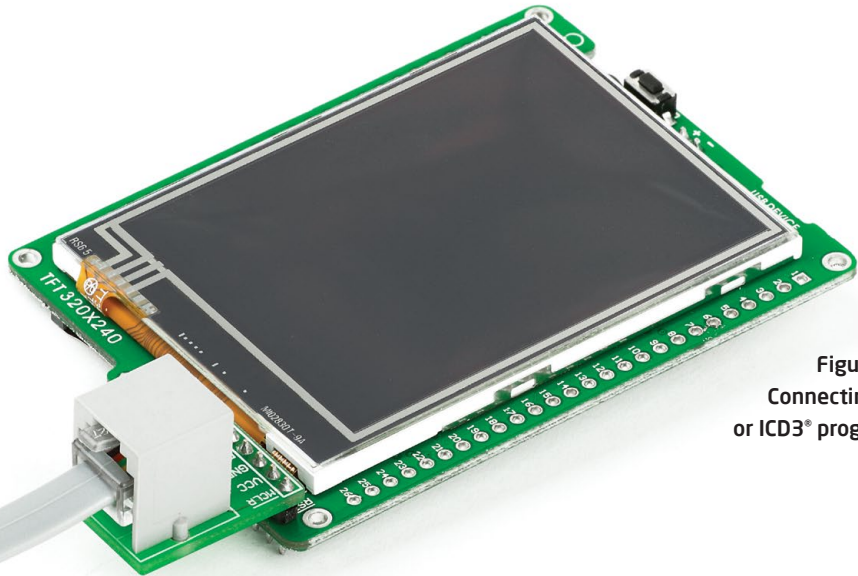

Figure 3-12:
Connecting ICD2[®]
or ICD3[®] programmer

In order to enable the ICD2[®] and ICD3[®] programmers to be connected to the mikromedia board, it is necessary to provide the appropriate connector such as the **ICD2 CONNECTOR BOARD**. This connector should be first soldered on the CN5 connector. Then you should plug the ICD2[®] or ICD3[®] programmer into it, **Figure 3-11**.

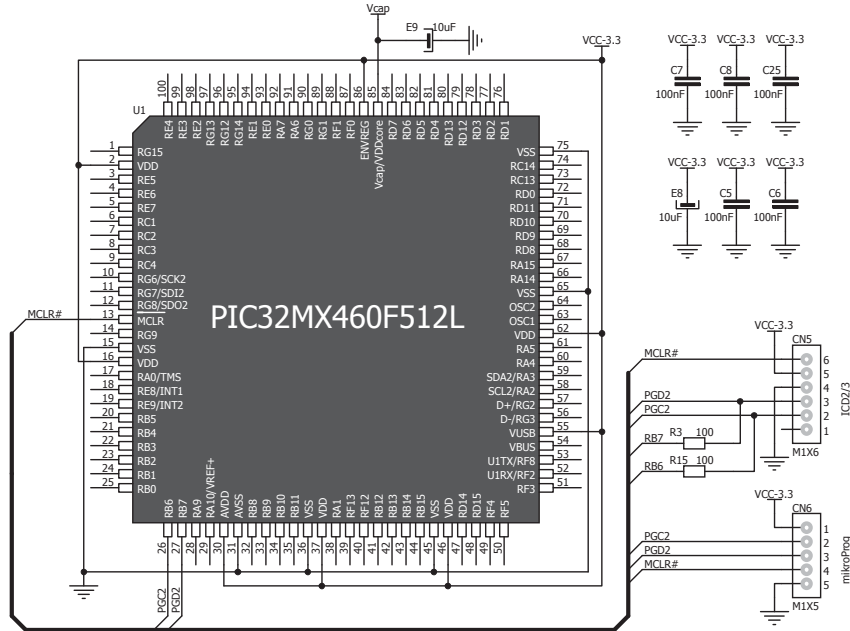
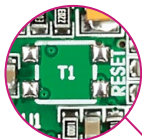
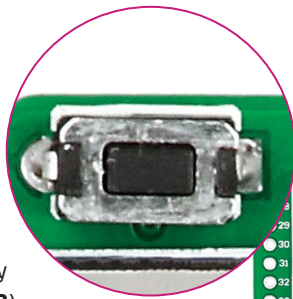

Figure 3-13: mikroProg™ & ICD2 / ICD3 programmer connection schematic

4. Reset button

Board is equipped with reset button, which is located at the top of the front side (**Figure 4-2**). If you want to reset the circuit, press the reset button. It will generate low voltage level on microcontroller reset pin (input). In addition, a reset can be externally provided through **pin 27** on side headers (**Figure 4-3**).



NOTE | You can also solder additional reset button on the appropriate place at the back side of the board, **Figure 4-1**.

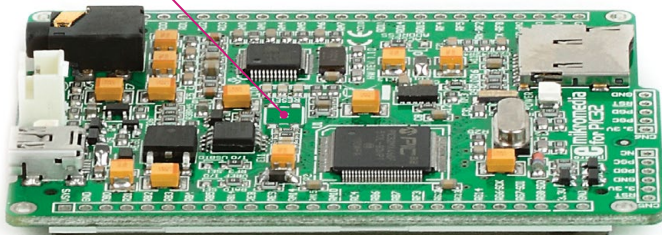

Figure 4-1: Location of additional reset button

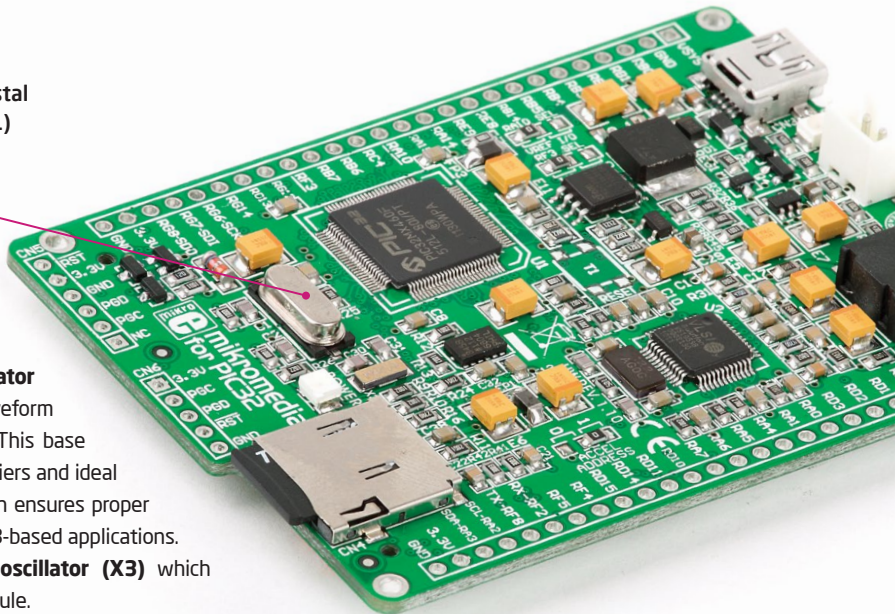

Figure 4-2: Frontal reset button

5. Crystal oscillator



Figure 5-1:
External crystal oscillator (X1)



Board is equipped with **8MHz crystal oscillator (X1)** circuit that provides external clock waveform to the microcontroller CLK0 and CLK1 pins. This base frequency is suitable for further clock multipliers and ideal for generation of necessary USB clock, which ensures proper operation of bootloader and your custom USB-based applications. Board also contains **32.768kHz Crystal oscillator (X3)** which provides external clock for internal **RTCC** module.

NOTE | *The use of crystal in all other schematics is implied even if it is purposely left out because of the schematics clarity.*

6. microSD card slot

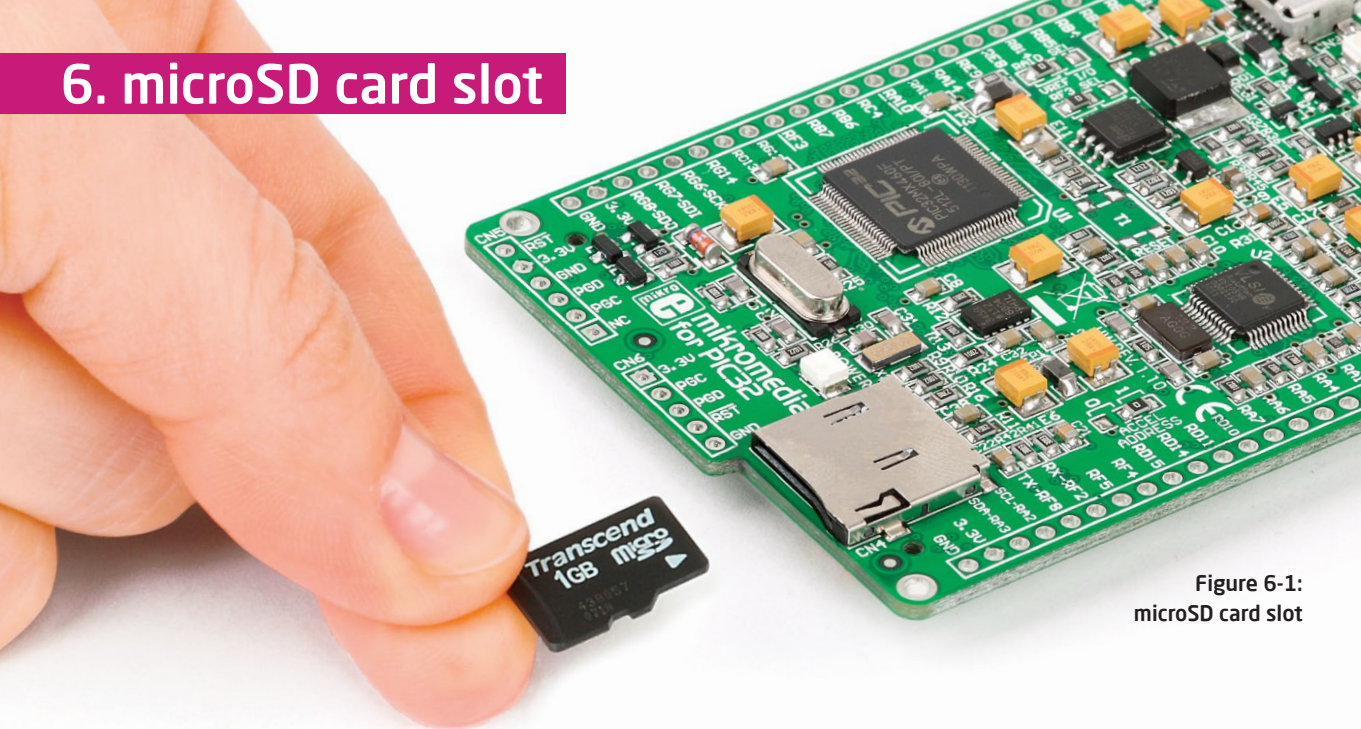

Figure 6-1:
microSD card slot

Board contains **microSD card slot** for using microSD cards in your projects. It enables you to store large amounts of data externally, thus saving microcontroller memory. microSD cards use Serial Peripheral Interface (**SPI**) for communication with the microcontroller.

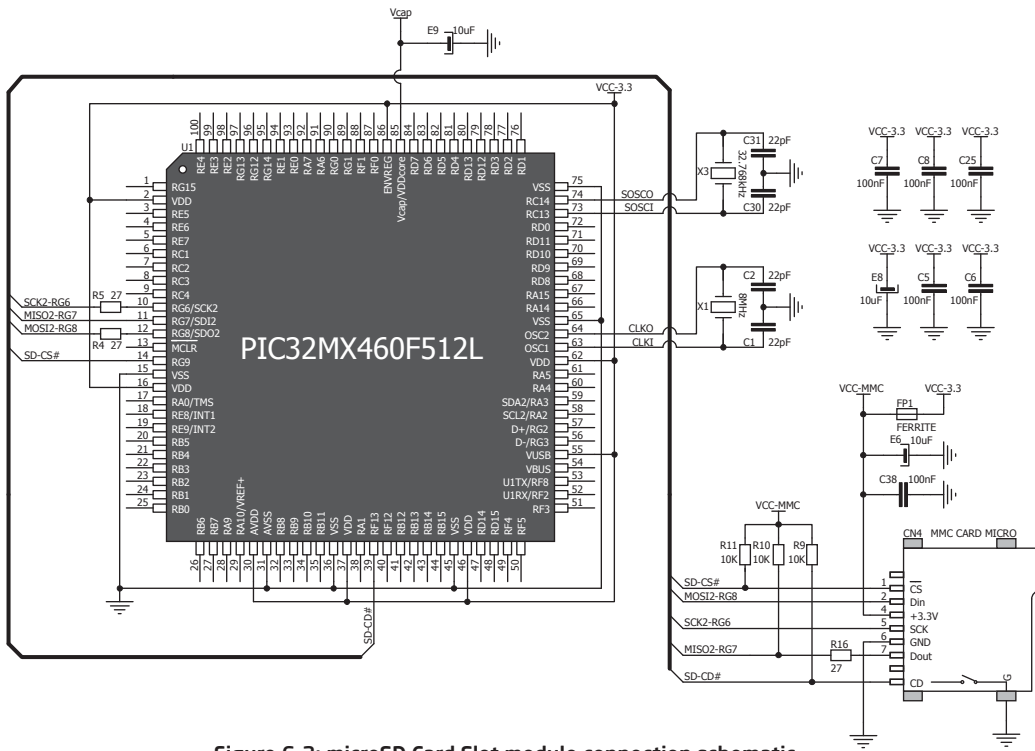

Figure 6-2: microSD Card Slot module connection schematic

7. Touch screen

The development system features a **TFT 320x240 display** covered with a **resistive** touch panel. Together they form a functional unit called a **touch screen**. It enables data to be entered and displayed at the same time. The TFT display is capable of showing graphics in **262.144** different colors.



Figure 7-1:
Touch Screen

8. Audio module

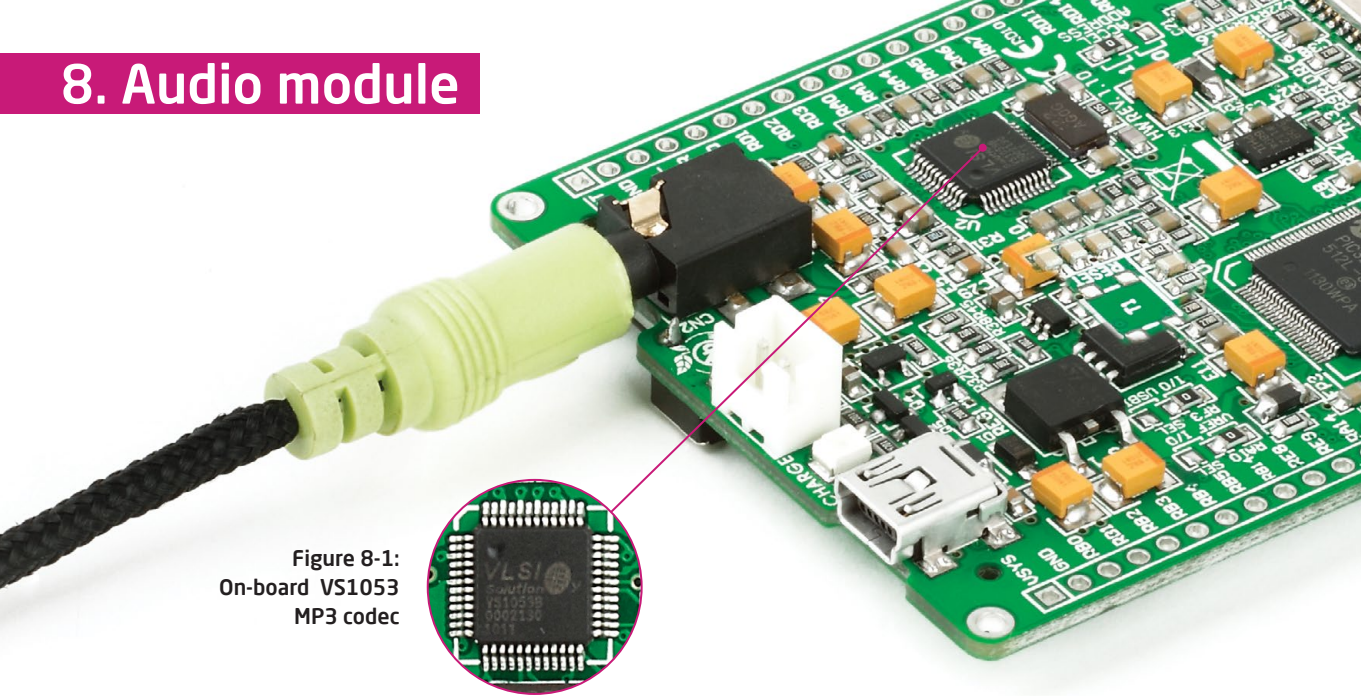

Figure 8-1:
On-board VS1053
MP3 codec

The mikromedia for PIC32® features stereo audio codec **VS1053**. This module enables audio reproduction by using stereo headphones connected to the system via a **3.5mm** connector CN2. All functions of this module are controlled by the microcontroller over Serial Peripheral Interface (**SPI**).

9. USB connection

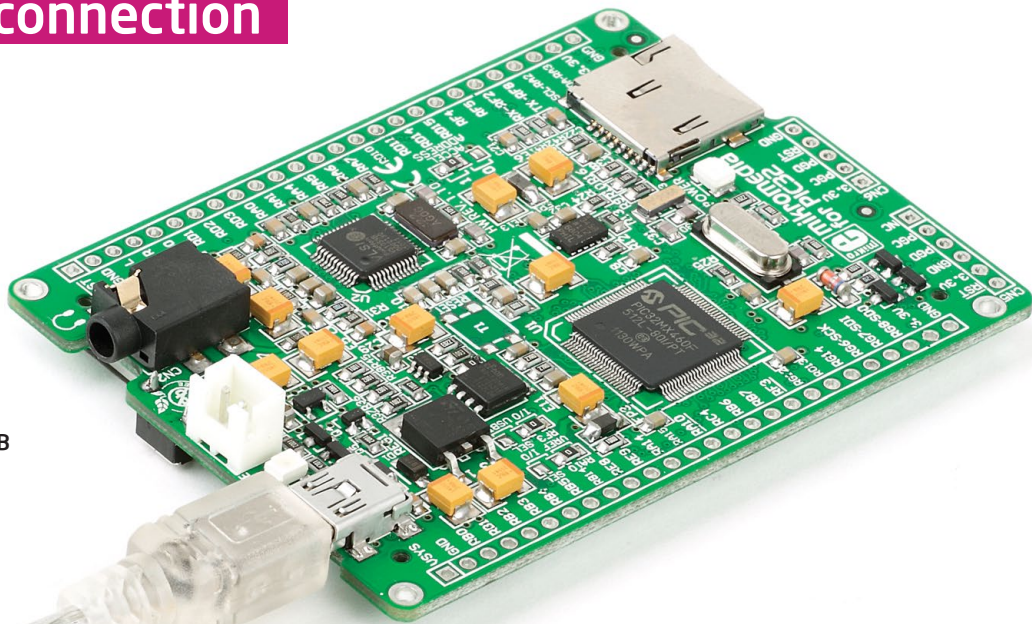

Figure 9-1:
Connecting USB
cable to MINI-B USB
connector

PIC32MX460F512L microcontroller has integrated USB module, which enables you to implement USB communication functionality to your mikromedia board. Connection with target USB host is done over MINI-B USB connector which is positioned next to the battery connector.

10. Accelerometer

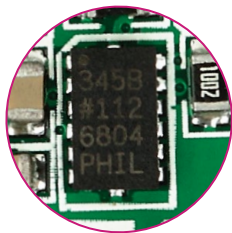
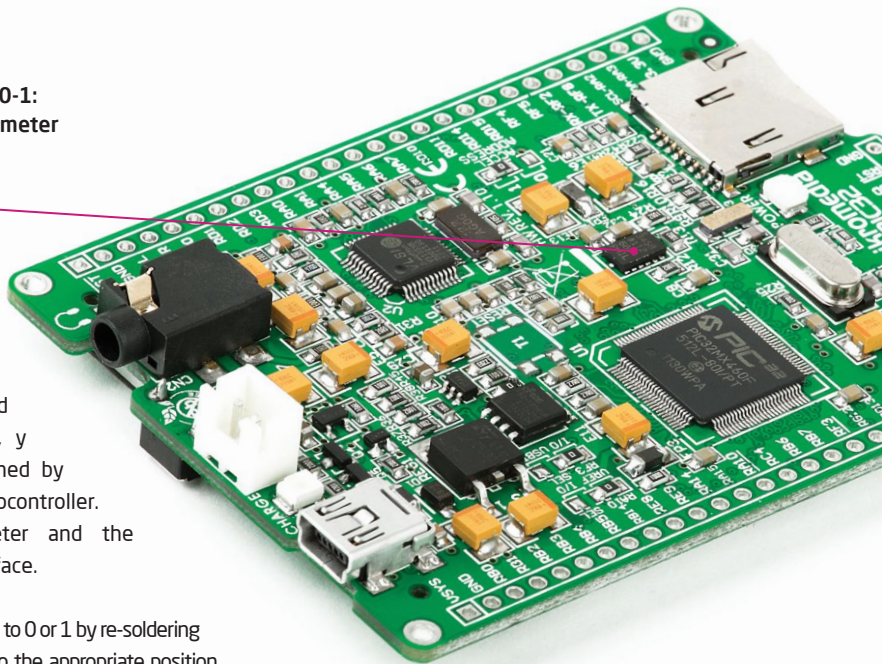

Figure 10-1:
Accelerometer
module



On board **ADXL345** accelerometer is used to measure acceleration in three axis: x, y and z. The accelerometer function is defined by the user in the program loaded into the microcontroller. Communication between the accelerometer and the microcontroller is performed via the **I²C** interface.



You can set the accelerometer address to 0 or 1 by re-soldering the SMD jumper (zero-ohm resistor) to the appropriate position. Jumper is placed in address 1 position by default.

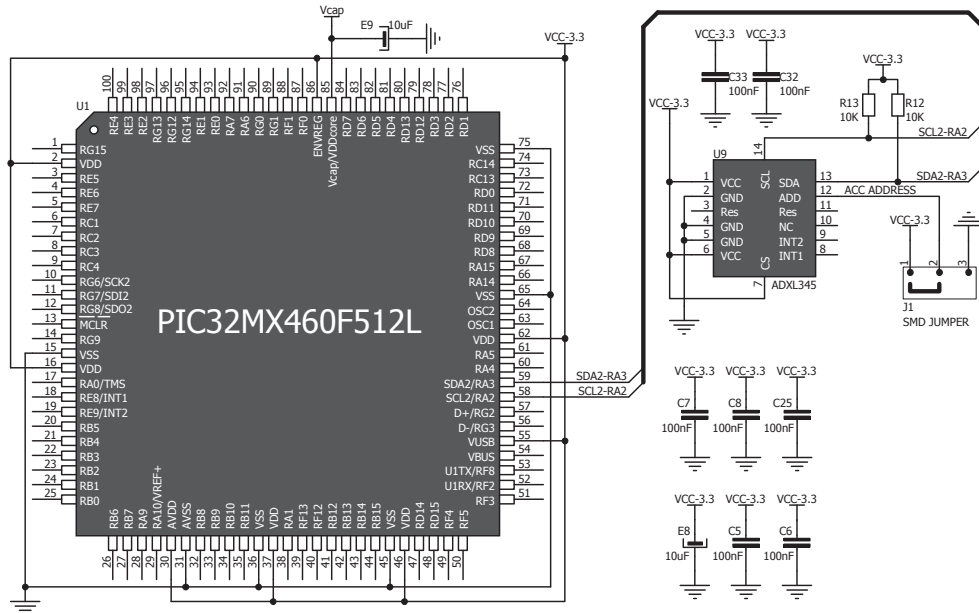
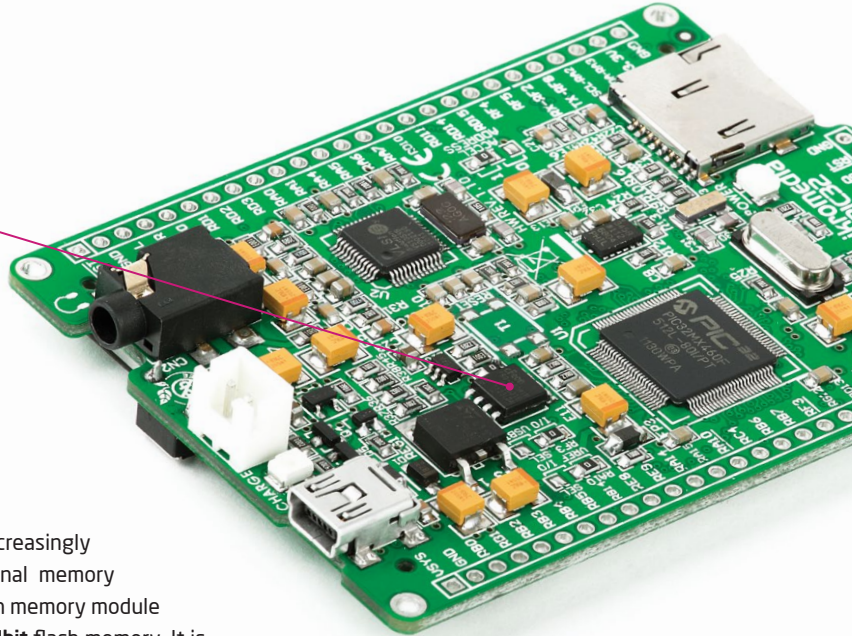

Figure 10-2: Accelerometer connection schematic

11. Flash memory

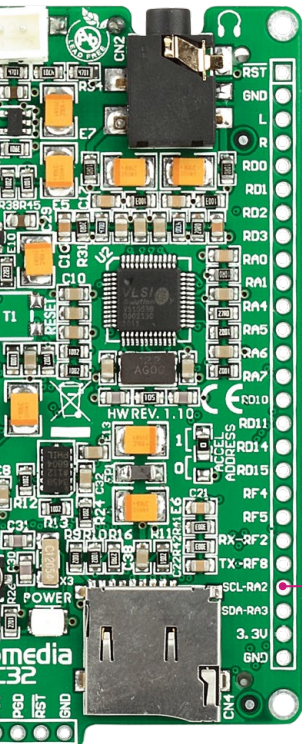

Figure 11-1:
Flash memory module



Since multimedia applications are getting increasingly demanding, it is necessary to provide additional memory space to be used for storing more data. The flash memory module enables the microcontroller to use additional **8Mbit** flash memory. It is connected to the microcontroller via the Serial Peripheral Interface (**SPI**).

12. Pads



Most microcontroller pins are available for further connectivity via two 1x26 rows of connection pads on both sides of the mikromedia board. They are designed to match additional shields, such as Battery Boost shield, Gaming, PROTO shield and others.

Note: pin **RA10** can be used either as an I/O or as VREF1.8. (to switch between those, solder jumper J2 in appropriate position).

Pads HDR2

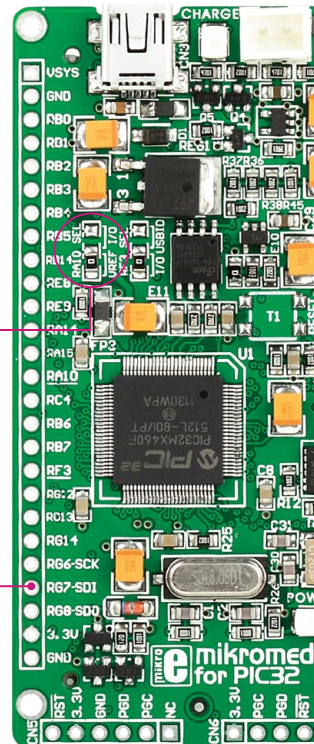

Pads HDR1

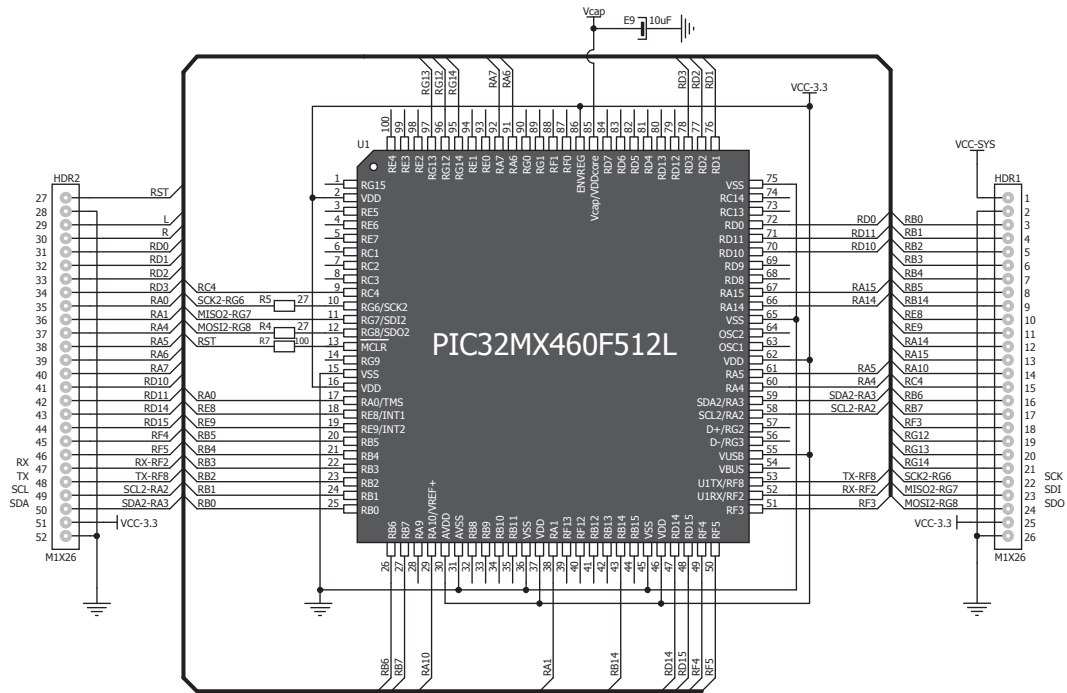
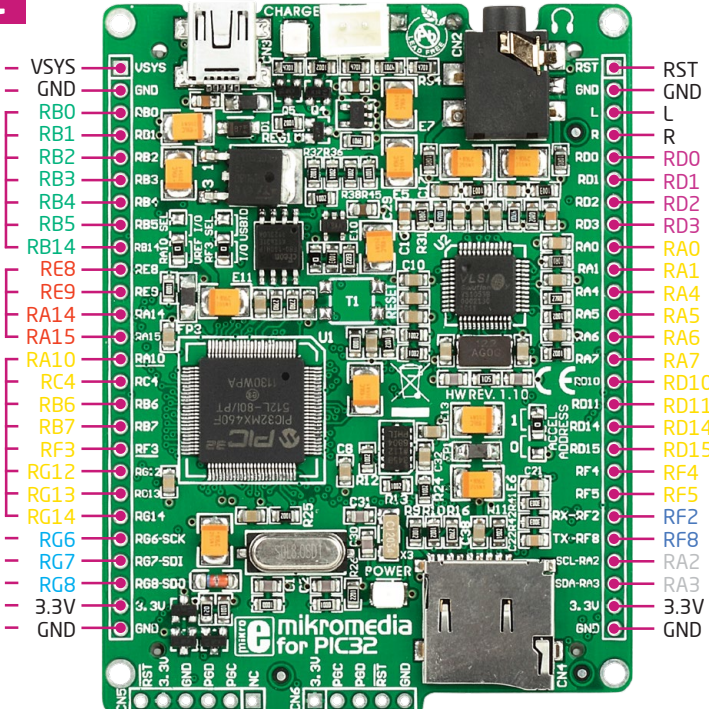

Figure 12-1: Connection pads schematic

13. Pinout

- 5V power supply
- Analog Lines
- Interrupt Lines
- Digital I/O lines
- SPI
- 3.3V power supply
- Reference Ground



- Reset pin
- Reference Ground
- left ch.] audio out
- right ch.]
- PWM lines
- Digital I/O lines
- UART
- I²C
- 3.3V power supply
- Reference Ground

■ Digital lines
 ■ Analog Lines
 ■ Interrupt Lines
 ■ SPI Lines
 ■ I²C Lines
 ■ UART lines
 ■ PWM lines

14. Dimensions

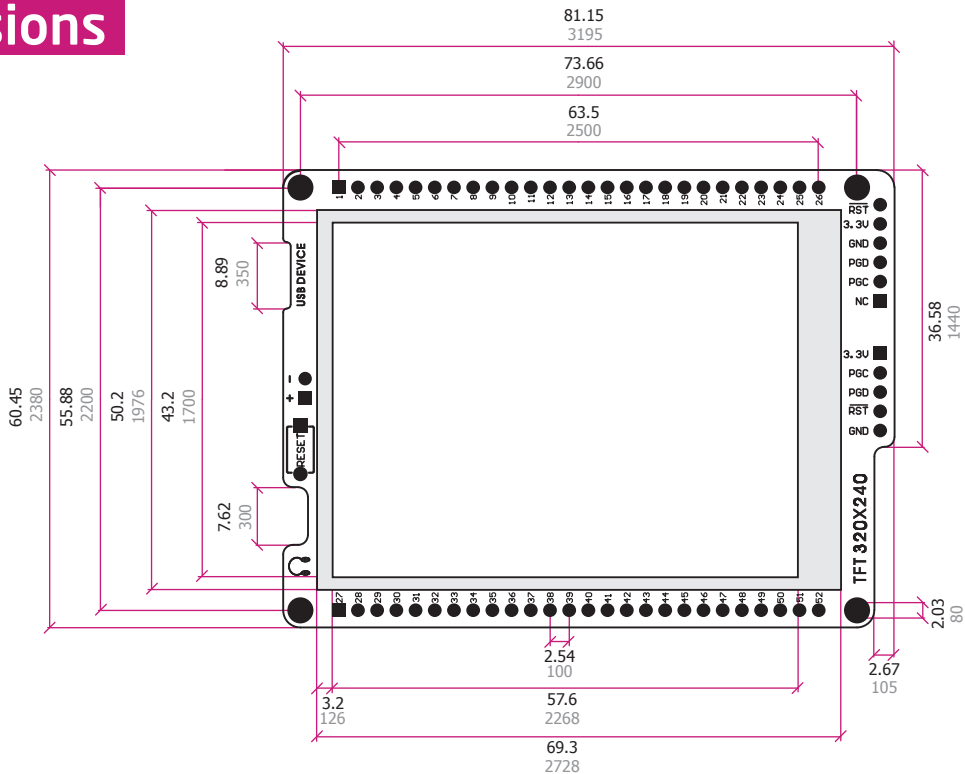
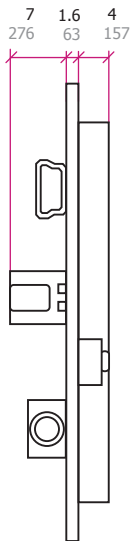

Legend

- mm
- mils

15. mikromedia accessories

We have prepared a set of extension boards pin-compatible with your mikromedia, which enable you to easily expand your board's basic functionality. We call them mikromedia shields. But we also offer other accessories, such as Li-polymer battery, stacking headers, wire jumpers and more.



01 Connect shield



02 BatteryBoost shield



03 PROTO shield

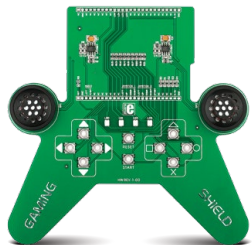

04 Gaming shield

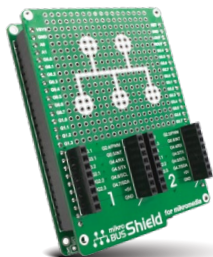

05 mikroBUS™ shield



06 Li-Polimer battery

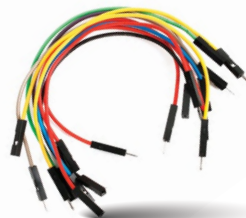

07 Wire jumpers

What's next?

You have now completed the journey through each and every feature of mikromedia for PIC32 board. You got to know its modules and organization. Now you are ready to start using your new board. We are suggesting several steps which are probably the best way to begin. Find useful projects and tutorials on the **Libstock** website (www.libstock.com). Join our **Forum** (www.mikroe.com/forum) and get help from a large ecosystem of users.

Compiler

You still don't have an appropriate compiler? Locate PIC32® compiler that suits you best on our site:



www.mikroe.com/pic/compilers

Choose between mikroC™, mikroBasic™ and mikroPascal™ and download a fully functional demo version, so you can begin building your first applications.

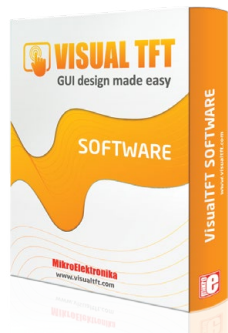

Visual TFT

Once you have chosen your compiler, and since you already got the board, you are ready to start writing your first projects. **Visual TFT software** enables you to quickly create your GUI. It will automatically generate code compatible with MikroElektronika compilers. Visual TFT is rich with examples, which are an excellent starting point for your future projects. Download it from the link below:



www.mikroe.com/visualtft

Notes:

DISCLAIMER

All the products owned by MikroElektronika are protected by copyright law and international copyright treaty. Therefore, this manual is to be treated as any other copyright material. No part of this manual, including product and software described herein, may be reproduced, stored in a retrieval system, translated or transmitted in any form or by any means, without the prior written permission of MikroElektronika. The manual PDF edition can be printed for private or local use, but not for distribution. Any modification of this manual is prohibited. MikroElektronika provides this manual 'as is' without warranty of any kind, either expressed or implied, including, but not limited to, the implied warranties or conditions of merchantability or fitness for a particular purpose. MikroElektronika shall assume no responsibility or liability for any errors, omissions and inaccuracies that may appear in this manual. In no event shall MikroElektronika, its directors, officers, employees or distributors be liable for any indirect, specific, incidental or consequential damages (including damages for loss of business profits and business information, business interruption or any other pecuniary loss) arising out of the use of this manual or product, even if MikroElektronika has been advised of the possibility of such damages. MikroElektronika reserves the right to change information contained in this manual at any time without prior notice, if necessary.

HIGH RISK ACTIVITIES

The products of MikroElektronika are not fault - tolerant nor designed, manufactured or intended for use or resale as on - line control equipment in hazardous environments requiring fail - safe performance, such as in the operation of nuclear facilities, aircraft navigation or communication systems, air traffic control, direct life support machines or weapons systems in which the failure of Software could lead directly to death, personal injury or severe physical or environmental damage ('High Risk Activities'). MikroElektronika and its suppliers specifically disclaim any expressed or implied warranty of fitness for High Risk Activities.

TRADEMARKS

The MikroElektronika name and logo, mikroC™, mikroBasic™, mikroPascal™, Visual TFT™, Visual GLCD™, mikroProg™, Ready™, MINI™, mikroBUS™, EasyPIC™, EasyAVR™, Easy8051™, click boards™ and mikromedia™ are trademarks of MikroElektronika. All other trademarks mentioned herein are property of their respective companies. All other product and corporate names appearing in this manual may or may not be registered trademarks or copyrights of their respective companies, and are only used for identification or explanation and to the owners' benefit, with no intent to infringe.

The PIC32® and Windows® logos and product names are trademarks of Microchip Technology® and Microsoft® in the U.S.A. and other countries.



If you want to learn more about our products, please visit our web site at www.mikroe.com

If you are experiencing some problems with any of our products or just need additional information, please place your ticket at www.mikroe.com/support

If you have any questions, comments or business proposals,
do not hesitate to contact us at office@mikroe.com

mikromedia for PIC32 Manual
ver. 1.10f



0100000079256



Компания «ЭлектроПласт» предлагает заключение долгосрочных отношений при поставках импортных электронных компонентов на взаимовыгодных условиях!

Наши преимущества:

- Оперативные поставки широкого спектра электронных компонентов отечественного и импортного производства напрямую от производителей и с крупнейших мировых складов;
- Поставка более 17-ти миллионов наименований электронных компонентов;
- Поставка сложных, дефицитных, либо снятых с производства позиций;
- Оперативные сроки поставки под заказ (от 5 рабочих дней);
- Экспресс доставка в любую точку России;
- Техническая поддержка проекта, помощь в подборе аналогов, поставка прототипов;
- Система менеджмента качества сертифицирована по Международному стандарту ISO 9001;
- Лицензия ФСБ на осуществление работ с использованием сведений, составляющих государственную тайну;
- Поставка специализированных компонентов (Xilinx, Altera, Analog Devices, Intersil, Interpoint, Microsemi, Aeroflex, Peregrine, Syfer, Eurofarad, Texas Instrument, Miteq, Cobham, E2V, MA-COM, Hittite, Mini-Circuits, General Dynamics и др.);

Помимо этого, одним из направлений компании «ЭлектроПласт» является направление «Источники питания». Мы предлагаем Вам помощь Конструкторского отдела:

- Подбор оптимального решения, техническое обоснование при выборе компонента;
- Подбор аналогов;
- Консультации по применению компонента;
- Поставка образцов и прототипов;
- Техническая поддержка проекта;
- Защита от снятия компонента с производства.



Как с нами связаться

Телефон: 8 (812) 309 58 32 (многоканальный)

Факс: 8 (812) 320-02-42

Электронная почта: org@eplast1.ru

Адрес: 198099, г. Санкт-Петербург, ул. Калинина, дом 2, корпус 4, литера А.