

# MM Series Subminiature Precision Snap-acting Switches

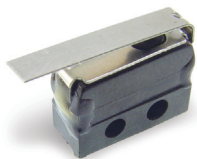

## Features/Benefits

- Low level and power switching
- Long electrical and mechanical life
- Increased overtravel
- Reliable snap-acting mechanism

## Typical Applications

- Limited space constraints
- Communication devices

## Specifications

CONTACT RATING: From low level\* to 7 AMPS @ 250 V AC.  
 ELECTRICAL LIFE: 100,000 cycles at full rated load.  
 INSULATION RESISTANCE: 1,000 ohm min.  
 DIELECTRIC STRENGTH: 1,000 V RMS min. @ sea level.  
 OPERATING TEMPERATURE: -67 F to 275 F (-55 C to 135 C).  
 OPERATING FORCE: 5 oz. (142 grams) max. at actuator button.  
 MOUNTING: 2-56 screws, torque 2 in/lbs max.

\*Low Level=conditions where no arcing occurs during switching, i.e., 0.4 VA max. @ 20 V AC or DC max.

**NOTE:** Specifications and materials listed above are for switches with standard options. For information on specific and custom switches, consult Customer Service center.

## Materials

SWITCH HOUSING: Heat resistant phenolic (UL 94V-0).  
 ACTUATOR BUTTON: Heat resistant phenolic (UL 94V-0).  
 SPRING: Beryllium copper CDA alloy C17200.  
 PIVOT: Brass CDA alloy 260.  
 MOVABLE CONTACTS: Fine silver for ratings greater than 1 AMP @ 125 V AC. 24K gold for 1 AMP @ 125 V AC or less.  
 STATIONARY CONTACTS: Fine silver inlay on copper CDA alloy C10200 for ratings greater than 1 AMP @ 125 V AC. 24K gold on copper CDA alloy C10200 for 1 AMP @ 125 V AC or less.  
 TERMINALS: Copper CDA alloy C18700.



Snap-acting

## Build-A-Switch

To order, simply select desired option from each category and place in the appropriate box. Available options are shown and described on pages J-44 through J-49. For additional options not shown in catalog, consult Customer Service Center.

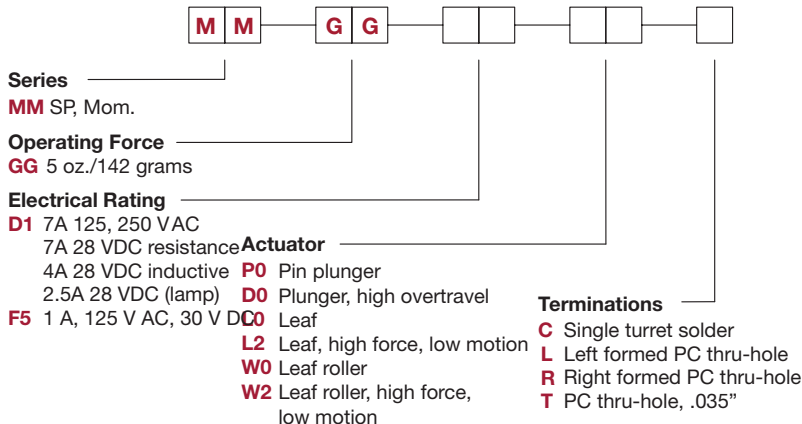

# MM Series Subminiature Precision Snap-acting Switches

## SWITCH WITH STANDARD OPTIONS

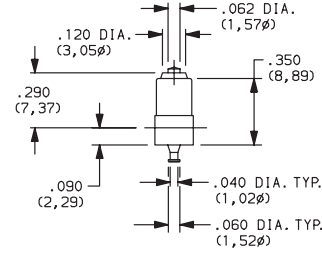
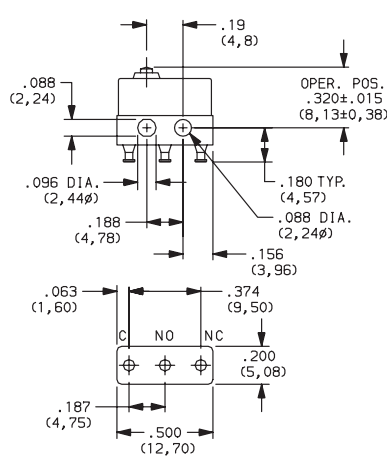

| PART NUMBER      | BASIC OPERATING FORCE (OZ./GRAMS) | ELECTRICAL RATING  |
|------------------|-----------------------------------|--------------------|
| <b>MMGGD1P0C</b> | 5<br>142                          | 7 AMPS @ 250 V AC. |

### SERIES ■■■■■■

**MM** SPDT MOMENTARY

### OPERATING FORCE ■■■■■■

| OPTION CODE | BASIC SWITCH OPERATING FORCE  |
|-------------|---|
| <b>GG</b>   | 5 oz. (142 grams) maximum for basic switch with pin plunger actuator (*'PO' actuator option). |

NOTE : Operating force varies with actuator option, see ACTUATOR option section.

### ELECTRICAL RATING ■■■■■■

| OPTION CODE | RoHS COMPLIANT* | RoHS COMPATIBLE* | CONTACT MATERIAL |                                    | ELECTRICAL RATING  |
|-------------|-----------------|------------------|------------------|------------------------------------|--|
|             |                 |                  | MOVABLE CONTACT  | STATIONARY CONTACT                 |  |
| <b>D1</b>   | Yes             | Yes              | Fine silver.     | Fine silver inlay on copper alloy. | 7A 125, 250 VAC; 7A 28 VDC resistance<br>4A 28 VDC inductive; 2.5A 28 VDC (lamp) |
| <b>F5</b>   | Yes             | Yes              | 24K Gold.        | 24K Gold on copper alloy.          | From low level* to 1 AMP<br>@ 125 V AC, 30 V DC.                                 |

Note: See Technical Data section of this catalog for RoHS compliant and compatible definition and specifications.

All models with all options.

Consult Customer Service Center for availability and delivery of nonstandard ratings.

\* Low Level=conditions where no arcing occurs during switching, i.e., 0.4 VA max. @ 20 V AC or DC max.

### ACTUATOR ■■■■■■

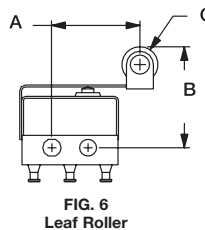
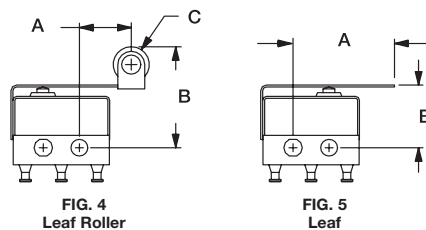
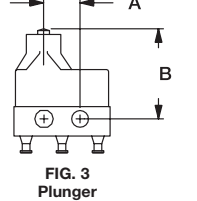
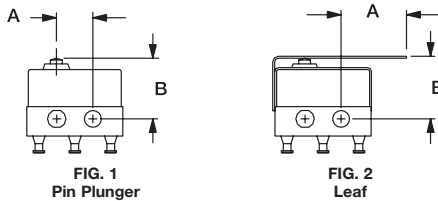

| OPTION CODE | FIG. | DIM. A     | DIM. B                     | DIM. C            |
|-------------|------|------------|----------------------------|-------------------|
| <b>P0</b>   | 1    | .19 (4,8)  | .320 ± .015 (8,13 ± 0,38)  | —                 |
| <b>D0</b>   | 3    | .19 (4,8)  | .475 ± .031 (12,07 ± 0,79) | —                 |
| <b>L0</b>   | 2    | .34 (8,6)  | .330 ± .015 (8,38 ± 0,38)  | —                 |
| <b>L2</b>   | 5    | .53 (13,5) | .330 ± .015 (8,38 ± 0,38)  | —                 |
| <b>W0</b>   | 4    | .27 (6,9)  | .532 ± .025 (13,51 ± 0,64) | .188 dia. (4,78φ) |
| <b>W2</b>   | 6    | .46 (11,7) | .532 ± .025 (13,51 ± 0,64) | .188 dia. (4,78φ) |



Dimensions are shown: Inches (mm)  
Specifications and dimensions subject to change



# MM Series Subminiature Precision Snap-acting Switches

## ACTUATOR

### SWITCH CHARACTERISTICS

| OPTION CODE | MAXIMUM OPERATING FORCE (OZ./GRAMS) | MINIMUM RELEASE FORCE (OZ./GRAMS) | MAXIMUM DIFFERENTIAL TRAVEL | MAXIMUM PRETRAVEL | MINIMUM OVERTRAVEL |
|-------------|-------------------------------------|-----------------------------------|-----------------------------|-------------------|--------------------|
| D0          | 5<br>142                            | .7<br>20                          | .004<br>(0,10)              | .030<br>(0,76)    | .040<br>(1,02)     |
| L0          | 4<br>115                            | .7<br>20                          | .025<br>(0,64)              | .090<br>(2,29)    | .045<br>(1,14)     |
| L2          | 6<br>170                            | .7<br>20                          | .012<br>(0,30)              | .075<br>(1,90)    | .015<br>(0,38)     |
| P0          | 5<br>142                            | 1<br>28                           | .002<br>(0,05)              | .020<br>(0,51)    | .004<br>(0,10)     |
| W0          | 4<br>115                            | .7<br>20                          | .025<br>(0,64)              | .090<br>(2,29)    | .045<br>(1,14)     |
| W2          | 6<br>170                            | .7<br>20                          | .012<br>(0,30)              | .075<br>(1,90)    | .015<br>(0,38)     |

NOTE : For basic switch operating forces, see page J-44

## TERMINATIONS

### C SINGLE TURRET SOLDER

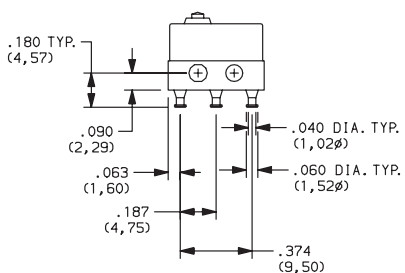

### L LEFT FORMED PC THRU-HOLE

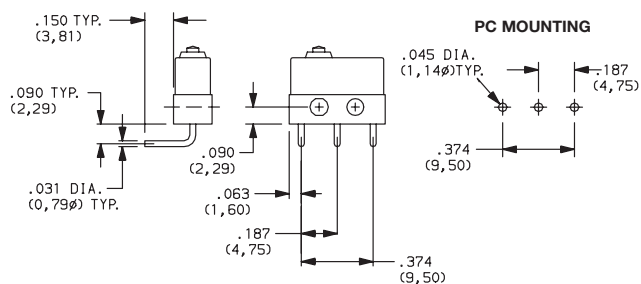

### T PC THRU-HOLE, .035"

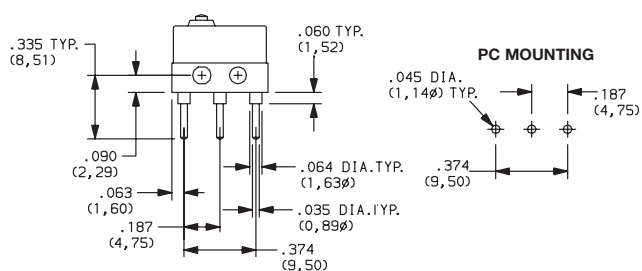

### R RIGHT FORMED PC THRU-HOLE

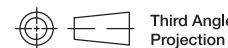
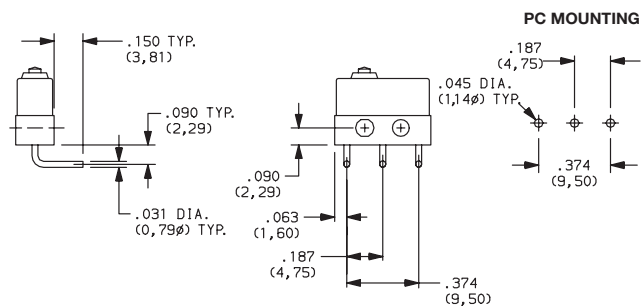

Third Angle  
Projection

Dimensions are shown: Inch (mm)  
Specifications and dimensions subject to change



Компания «ЭлектроПласт» предлагает заключение долгосрочных отношений при поставках импортных электронных компонентов на взаимовыгодных условиях!

Наши преимущества:

- Оперативные поставки широкого спектра электронных компонентов отечественного и импортного производства напрямую от производителей и с крупнейших мировых складов;
- Поставка более 17-ти миллионов наименований электронных компонентов;
- Поставка сложных, дефицитных, либо снятых с производства позиций;
- Оперативные сроки поставки под заказ (от 5 рабочих дней);
- Экспресс доставка в любую точку России;
- Техническая поддержка проекта, помощь в подборе аналогов, поставка прототипов;
- Система менеджмента качества сертифицирована по Международному стандарту ISO 9001;
- Лицензия ФСБ на осуществление работ с использованием сведений, составляющих государственную тайну;
- Поставка специализированных компонентов (Xilinx, Altera, Analog Devices, Intersil, Interpoint, Microsemi, Aeroflex, Peregrine, Syfer, Eurofarad, Texas Instrument, Miteq, Cobham, E2V, MA-COM, Hittite, Mini-Circuits, General Dynamics и др.);

Помимо этого, одним из направлений компании «ЭлектроПласт» является направление «Источники питания». Мы предлагаем Вам помощь Конструкторского отдела:

- Подбор оптимального решения, техническое обоснование при выборе компонента;
- Подбор аналогов;
- Консультации по применению компонента;
- Поставка образцов и прототипов;
- Техническая поддержка проекта;
- Защита от снятия компонента с производства.



#### Как с нами связаться

**Телефон:** 8 (812) 309 58 32 (многоканальный)

**Факс:** 8 (812) 320-02-42

**Электронная почта:** [org@eplast1.ru](mailto:org@eplast1.ru)

**Адрес:** 198099, г. Санкт-Петербург, ул. Калинина, дом 2, корпус 4, литера А.