

Voltage Detector IC Series

# Free Delay Time Setting

# CMOS Voltage Detector IC Series



BD52xx series BD53xx series

●General Description

Rohm's BD52xx and BD53xx series are highly accurate, low current consumption Voltage Detector ICs with a capacitor-controlled time delay. The line up includes BD52xx devices with N channel open drain output and BD53xx devices with CMOS output. The devices are available for specific detection voltages ranging from 2.3V to 6.0V in increments of 0.1V.

●Features

- Delay Time Controlled by external Capacitor
- Two output types (N channel open drain and CMOS output)
- Ultra-low current consumption
- Very small and low height package
- Package SSOP5 is similar to SOT-23-5(JEDEC)

●Typical Application Circuit

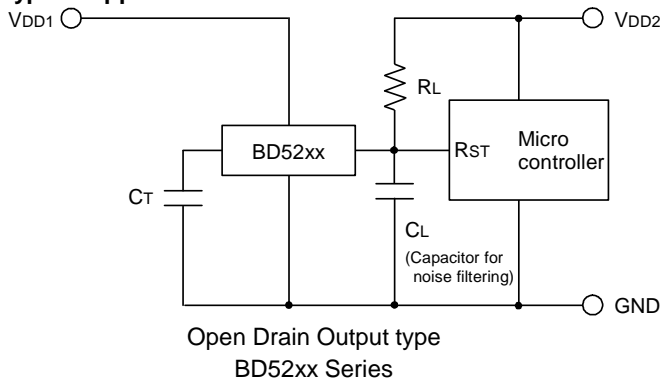

●Key Specifications

- Detection voltage: 2.3V to 6.0V (Typ.)  
0.1V steps
- High accuracy detection voltage: ±1.0%
- Ultra-low current consumption: 0.95µA (Typ.)

●Package

- SSOP5: 2.90mm x 2.80mm x 1.25mm
- VSO5F5: 1.60mm x 1.60mm x 0.60mm

●Applications

Circuits using microcontrollers or logic circuits that require a reset.



●Connection Diagram

SSOP5

TOP VIEW

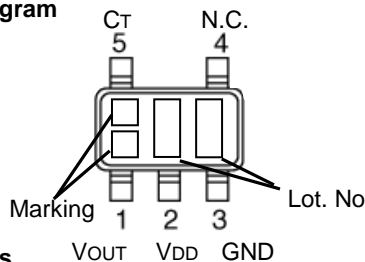

VSO5F5

TOP VIEW



●Pin Descriptions

SSOP5		
PIN No.	Symbol	Function
1	VOUT	Reset Output
2	VDD	Power Supply Voltage
3	GND	GND
4	N.C.	Unconnected Terminal
5	C <sub>T</sub>	Capacitor connection terminal for output delay time

VSO5F5		
PIN No.	Symbol	Function
1	VOUT	Reset Output
2	SUB	Substrate*
3	C <sub>T</sub>	Capacitor connection terminal for output delay time
4	GND	GND
5	VDD	Power Supply Voltage

\*Connect the substrate to GND.

●Ordering Information

B	D	X	X	X	X	X	-	T	R
---	---	---	---	---	---	---	---	---	---

Part Number	Output Type 52 : Open Drain 53 : CMOS	Reset Voltage Value 23 : 2.3V ↓ 0.1V step 60 : 6.0V	Package G : SSOP5 FVE : VSOF5	Packaging and forming specification TR : Embossed tape and reel
-------------	---	--	-------------------------------------	--

SSOP5



VSOF5



## ●Lineup

Output Type	Open Drain		CMOS	
Detection Voltage	Marking	Part Number	Marking	Part Number
6.0V	PW	BD5260	RW	BD5360
5.9V	PV	BD5259	RV	BD5359
5.8V	PU	BD5258	RU	BD5358
5.7V	PT	BD5257	RT	BD5357
5.6V	PS	BD5256	RS	BD5356
5.5V	PR	BD5255	RR	BD5355
5.4V	PQ	BD5254	RQ	BD5354
5.3V	PP	BD5253	RP	BD5353
5.2V	PN	BD5252	RN	BD5352
5.1V	PM	BD5251	RM	BD5351
5.0V	PL	BD5250	RL	BD5350
4.9V	PK	BD5249	RK	BD5349
4.8V	PJ	BD5248	RJ	BD5348
4.7V	PH	BD5247	RH	BD5347
4.6V	PG	BD5246	RG	BD5346
4.5V	PF	BD5245	RF	BD5345
4.4V	PE	BD5244	RE	BD5344
4.3V	PD	BD5243	RD	BD5343
4.2V	PC	BD5242	RC	BD5342
4.1V	PB	BD5241	RB	BD5341
4.0V	PA	BD5240	RA	BD5340
3.9V	MV	BD5239	QV	BD5339
3.8V	MU	BD5238	QU	BD5338
3.7V	MT	BD5237	QT	BD5337
3.6V	MS	BD5236	QS	BD5336
3.5V	MR	BD5235	QR	BD5335
3.4V	MQ	BD5234	QQ	BD5334
3.3V	MP	BD5233	QP	BD5333
3.2V	MN	BD5232	QN	BD5332
3.1V	MM	BD5231	QM	BD5331
3.0V	ML	BD5230	QL	BD5330
2.9V	MK	BD5229	QK	BD5329
2.8V	MJ	BD5228	QJ	BD5328
2.7V	MH	BD5227	QH	BD5327
2.6V	MG	BD5226	QG	BD5326
2.5V	MF	BD5225	QF	BD5325
2.4V	ME	BD5224	QE	BD5324
2.3V	MD	BD5223	QD	BD5323

## ● Absolute maximum ratings

Parameter		Symbol	Limits	Unit
Power Supply Voltage		$V_{DD-GND}$	-0.3 to +10	V
Output Voltage	Nch Open Drain Output	$V_{OUT}$	GND-0.3 to +10	V
	CMOS Output		GND-0.3 to $V_{DD}+0.3$	
Output Current		$I_o$	80	mA
Power	SSOP5 <sup>*1*3</sup>	$P_d$	540	mW
Dissipation	VSO5 <sup>*2*3</sup>		210	
Operating Temperature		$T_{opr}$	-40 to +105	°C
Ambient Storage Temperature		$T_{stg}$	-55 to +125	°C

\*1 Reduced by 5.4mW/°C when used over 25°C.

\*2 Reduced by 2.1mW/°C when used over 25°C.

\*3 When mounted on ROHM standard circuit board (70mm×70mm×1.6mm, glass epoxy board).

● Electrical characteristics (Unless Otherwise Specified  $T_a=-40$  to  $105^\circ\text{C}$ )

Parameter	Symbol	Condition	Limit			Unit		
			Min.	Typ.	Max.			
Detection Voltage	$V_{DET}$	$V_{DD}=H \rightarrow L, R_L=470k\Omega$ <sup>*1</sup>	$V_{DET}(T) \times 0.99$	$V_{DET}(T)$	$V_{DET}(T) \times 1.01$	V		
			$V_{DET}=2.5V$	$T_a=+25^\circ\text{C}$	2.475		2.5	2.525
				$T_a=-40^\circ\text{C}$ to $85^\circ\text{C}$	2.418		-	2.584
		$T_a=85^\circ\text{C}$ to $105^\circ\text{C}$		2.404	-		2.597	
		$V_{DET}=3.0V$	$T_a=+25^\circ\text{C}$	2.970	3.0		3.030	
			$T_a=-40^\circ\text{C}$ to $85^\circ\text{C}$	2.901	-		3.100	
			$T_a=85^\circ\text{C}$ to $105^\circ\text{C}$	2.885	-		3.117	
		$V_{DET}=3.3V$	$T_a=+25^\circ\text{C}$	3.267	3.3		3.333	
			$T_a=-40^\circ\text{C}$ to $85^\circ\text{C}$	3.191	-		3.410	
			$T_a=85^\circ\text{C}$ to $105^\circ\text{C}$	3.173	-		3.428	
		$V_{DET}=4.2V$	$T_a=+25^\circ\text{C}$	4.158	4.2		4.242	
			$T_a=-40^\circ\text{C}$ to $85^\circ\text{C}$	4.061	-		4.341	
$T_a=85^\circ\text{C}$ to $105^\circ\text{C}$	4.039		-	4.364				
$V_{DET}=4.8V$	$T_a=+25^\circ\text{C}$	4.752	4.8	4.848				
	$T_a=-40^\circ\text{C}$ to $85^\circ\text{C}$	4.641	-	4.961				
	$T_a=85^\circ\text{C}$ to $105^\circ\text{C}$	4.616	-	4.987				
Circuit Current when ON	$I_{DD1}$	$V_{DD}=V_{DET}-0.2V$	$V_{DET}=2.3-3.1V$	-	0.80	$\mu\text{A}$		
			$V_{DET}=3.2-4.2V$	-	0.85			
			$V_{DET}=4.3-5.2V$	-	0.90			
			$V_{DET}=5.3-6.0V$	-	0.95			
Circuit Current when OFF	$I_{DD2}$	$V_{DD}=V_{DET}+2.0V$	$V_{DET}=2.3-3.1V$	-	0.75	$\mu\text{A}$		
			$V_{DET}=3.2-4.2V$	-	0.80			
			$V_{DET}=4.3-5.2V$	-	0.85			
			$V_{DET}=5.3-6.0V$	-	0.90			
Operating Voltage Range	$V_{OPL}$	$V_{OL} \leq 0.4V, T_a=25$ to $105^\circ\text{C}, R_L=470k\Omega$	0.95	-	-	V		
		$V_{OL} \leq 0.4V, T_a=-40$ to $25^\circ\text{C}, R_L=470k\Omega$	1.20	-	-			
'Low' Output Voltage (Nch)	$V_{OL}$	$V_{DD}=1.5V, I_{SINK}=0.4$ mA, $V_{DET}=2.3-6.0V$	-	-	0.5	V		
		$V_{DD}=2.4V, I_{SINK}=2.0$ mA, $V_{DET}=2.7-6.0V$	-	-	0.5			
'High' Output Voltage (Pch)	$V_{OH}$	$V_{DD}=4.8V, I_{SOURCE}=0.7$ mA, $V_{DET}(2.3V$ to $4.2V)$	$V_{DD}-0.5$	-	-	V		
		$V_{DD}=6.0V, I_{SOURCE}=0.9$ mA, $V_{DET}(4.3V$ to $5.2V)$	$V_{DD}-0.5$	-	-			
		$V_{DD}=8.0V, I_{SOURCE}=1.1$ mA, $V_{DET}(5.3V$ to $6.0V)$	$V_{DD}-0.5$	-	-			

 $V_{DET}(T)$ : Standard Detection Voltage (2.3V to 6.0V, 0.1V step) $R_L$ : Pull-up resistor to be connected between  $V_{OUT}$  and power supply.

Design Guarantee. (Outgoing inspection is not done on all products.)

\*1 Guaranteed at  $T_a=25^\circ\text{C}$ .

## ● Electrical characteristics (Unless Otherwise Specified Ta=-40 to 105°C) - continued

Parameter	Symbol	Condition	Limit			Unit
			Min.	Typ.	Max.	
Leak Current	$I_{leak}$	$V_{DD}=V_{DS}=10V$ *1	-	-	0.1	$\mu A$
$C_T$ pin Threshold Voltage	$V_{CTH}$	$V_{DD}=V_{DET}\times 1.1, V_{DET}=2.3-2.6V, R_L=470k\Omega$	$V_{DD}$ $\times 0.30$	$V_{DD}$ $\times 0.40$	$V_{DD}$ $\times 0.60$	V
		$V_{DD}=V_{DET}\times 1.1, V_{DET}=2.7-4.2V, R_L=470k\Omega$	$V_{DD}$ $\times 0.30$	$V_{DD}$ $\times 0.45$	$V_{DD}$ $\times 0.60$	
		$V_{DD}=V_{DET}\times 1.1, V_{DET}=4.3-5.2V, R_L=470k\Omega$	$V_{DD}$ $\times 0.35$	$V_{DD}$ $\times 0.50$	$V_{DD}$ $\times 0.60$	
		$V_{DD}=V_{DET}\times 1.1, V_{DET}=5.3-6.0V, R_L=470k\Omega$	$V_{DD}$ $\times 0.40$	$V_{DD}$ $\times 0.50$	$V_{DD}$ $\times 0.60$	
Output Delay Resistance	$R_{CT}$	$V_{DD}=V_{DET}\times 1.1 \quad V_{CT}=0.5V$ *1	5.5	9	12.5	$M\Omega$
$C_T$ pin Output Current	$I_{CT}$	$V_{CT}=0.1V \quad V_{DD}=0.95V$ *1	15	40	-	$\mu A$
		$V_{CT}=0.5V \quad V_{DD}=1.5V$	150	240	-	
Detection Voltage Temperature coefficient	$V_{DET}/\Delta T$	Ta=-40°C to 105°C	-	$\pm 100$	$\pm 360$	ppm/°C
Hysteresis Voltage	$\Delta V_{DET}$	$V_{DD}=L \rightarrow H \rightarrow L, R_L=470k\Omega$	$V_{DET}$ $\times 0.03$	$V_{DET}$ $\times 0.05$	$V_{DET}$ $\times 0.08$	V

$V_{DET}(T)$ : Standard Detection Voltage (2.3V to 6.0V, 0.1V step)

$R_L$ : Pull-up resistor to be connected between  $V_{OUT}$  and power supply.  
Design Guarantee. (Outgoing inspection is not done on all products.)

\*1 Guaranteed at Ta=25°C.

●Block Diagrams



Fig.1 BD52xx Series



Fig.2 BD53xx Series

● Typical Performance Curves



Fig.3 Circuit Current



Fig.4 "Low" Output Current



Fig.5 "High" Output Current



Fig.6 I/O Characteristics

● Typical Performance Curves – continued



Fig.7 Operating Limit Voltage



Fig.8 CT Terminal Current

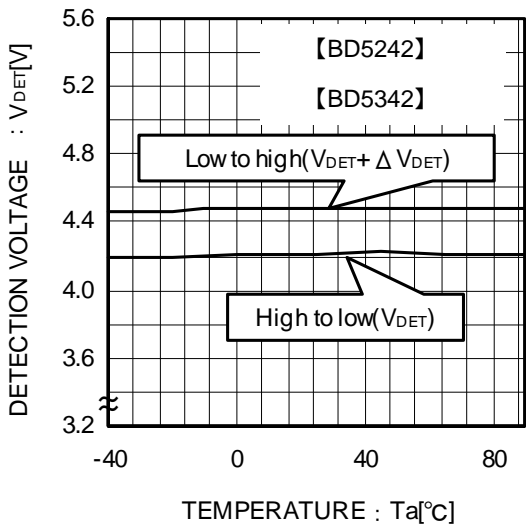

Fig.9 Detection Voltage Release Voltage



Fig.10 Circuit Current when ON



● Typical Performance Curves – continued



Fig.11 Circuit Current when OFF



Fig.12 Operating Limit Voltage



Fig.13  $C_T$  Terminal Circuit Resistance



Fig.14 Delay Time ( $t_{PLH}$ ) and  $C_T$  Terminal External Capacitance

● Application Information

Explanation of Operation

For both the open drain type (Fig.15) and the CMOS output type (Fig.16), the detection and release voltages are used as threshold voltages. When the voltage applied to the V<sub>DD</sub> pins reaches the applicable threshold voltage, the V<sub>OUT</sub> terminal voltage switches from either “High” to “Low” or from “Low” to “High”. Please refer to the Timing Waveform and Electrical Characteristics for information on hysteresis. Because the BD52xx series uses an open drain output type, it is necessary to connect a pull-up resistor to V<sub>DD</sub> or another power supply if needed [The output “High” voltage (V<sub>OUT</sub>) in this case becomes V<sub>DD</sub> or the voltage of the other power supply].



Fig.15 (BD52xxType Internal Block Diagram)



Fig.16 (BD53xxType Internal Block Diagram)

Setting of Detector Delay Time

It is possible to set the delay time at the rise of V<sub>DD</sub> using a capacitor connected to the C<sub>T</sub> terminal.

Delay time at the rise of V<sub>DD</sub> t<sub>PLH</sub>: Time until when V<sub>out</sub> rise to 1/2 of V<sub>DD</sub> after V<sub>DD</sub> rise up and beyond the release voltage (V<sub>DET</sub>+ΔV<sub>DET</sub>)

$$t_{PLH} = -C_{CT} \times R_{CT} \times \ln \left( \frac{V_{DD} - V_{CTH}}{V_{DD}} \right)$$

C<sub>CT</sub>: C<sub>T</sub> pin External Capacitance

R<sub>CT</sub>: C<sub>T</sub> pin Internal Impedance (Please refer to Electrical Characteristics.)

V<sub>CTH</sub>: C<sub>T</sub> pin Threshold Voltage (Please refer to Electrical Characteristics.)

ln : Natural Logarithm

Reference Data of Falling Time (t<sub>PHL</sub>) Output

Examples of Falling Time (t<sub>PHL</sub>) Output

Part Number	t <sub>PHL</sub> [μs] -40°C	t <sub>PHL</sub> [μs] ,+25°C	t <sub>PHL</sub> [μs],+105°C
BD5227	30.8	30	28.8
BD5327	26.8	26	24.8

\*This data is for reference only.

The figures will vary with the application, so please confirm actual operating conditions before use.

Timing Waveforms

Example: the following shows the relationship between the input voltage V<sub>DD</sub>, the C<sub>T</sub> Terminal Voltage V<sub>CT</sub> and the output voltage V<sub>OUT</sub> when the input power supply voltage V<sub>DD</sub> is made to sweep up and sweep down (The circuits are those in Figure.15 and 16).



Fig.17 Timing Waveform

- ① When the power supply is turned on, the output is unstable from after over the operating limit voltage (V<sub>OPL</sub>) until t<sub>PHL</sub>. Therefore it is possible that the reset signal is not outputted when the rise time of V<sub>DD</sub> is faster than t<sub>PHL</sub>.
- ② When V<sub>DD</sub> is greater than V<sub>OPL</sub> but less than the reset release voltage (V<sub>DET</sub>+ΔV<sub>DET</sub>), the C<sub>T</sub> terminal (V<sub>CT</sub>) and output (V<sub>OUT</sub>) voltages will switch to L.
- ③ If V<sub>DD</sub> exceeds the reset release voltage (V<sub>DET</sub>+ΔV<sub>DET</sub>), then V<sub>OUT</sub> switches from L to H (with a delay due to the C<sub>T</sub> terminal).
- ④ If V<sub>DD</sub> drops below the detection voltage (V<sub>DET</sub>) when the power supply is powered down or when there is a power supply fluctuation, V<sub>OUT</sub> switches to L (with a delay of t<sub>PHL</sub>).
- ⑤ The potential difference between the detection voltage and the release voltage is known as the hysteresis width (ΔV<sub>DET</sub>). The system is designed such that the output does not toggle with power supply fluctuations within this hysteresis width, preventing malfunctions due to noise.

●Circuit Applications

1) Examples of a common power supply detection reset circuit



Fig.18 Open Drain Output Type



Fig.19 CMOS Output Type

Application examples of BD52xx series (Open Drain output type) and BD53xx series (CMOS output type) are shown below.

CASE1: Power supply of the microcontroller ( $V_{DD2}$ ) differs from the power supply of the reset detection ( $V_{DD1}$ ).

Use an open drain output type (BD52xx) device with a load resistance  $R_L$  attached as shown Fig.18.

CASE2: Power supply of the microcontroller ( $V_{DD1}$ ) is the same as the power supply of the reset detection ( $V_{DD1}$ ).

Use a CMOS output type (BD53xx) device or an open drain output type (BD52xx) device with a pull up resistor between the output and  $V_{DD1}$ .

When a capacitance  $C_L$  for noise filtering is connected to the  $V_{OUT}$  pin (the reset signal input terminal of the microcontroller), please take into account the waveform of the rise and fall of the output voltage ( $V_{OUT}$ ).

Please refer to Operational Notes for recommendations on resistor and capacitor values.

2) The following is an example of a circuit application in which an OR connection between two types of detection voltage resets the microcontroller.



Fig.20

To reset the microcontroller when many independent power supplies are used in the system, OR connect an open drain output type (BD52xx series) to the microcontroller's input with pull-up resistor to the supply voltage of the microcontroller ( $V_{DD3}$ ) as shown in Fig. 20. By pulling-up to  $V_{DD3}$ , output "High" voltage of micro-controller power supply is possible.

3) Examples of the power supply with resistor dividers

In applications wherein the power supply voltage of an IC comes from a resistor divider circuit, an in-rush current will flow into the circuit when the output level switches from “High” to “Low” or vice versa. In-rush current is a sudden surge of current that flows from the power supply (VDD) to ground (GND) as the output logic changes its state. This current flow may cause malfunction in the systems operation such as output oscillations, etc.



When an in-rush current ( $I_1$ ) flows into the circuit (Refer to Fig. 21) at the time when output switches from “Low” to “High”, a voltage drop of  $I_1 \times R_2$  (input resistor) will occur in the circuit causing the VDD supply voltage to decrease. When the VDD voltage drops below the detection voltage, the output will switch from “High” to “Low”. While the output voltage is at “Low” condition, in-rush current will stop flowing and the voltage drop will be reduced. As a result, the output voltage will switch again from “Low” to “High” which causes an in-rush current and a voltage drop. This operation repeats and will result to oscillation.



Figure.22 IDD Peak Current vs. Power Supply Voltage

\* This data is for reference only.  
The figures will vary with the application, so please confirm actual operating conditions before use.

**●Operational Notes**

- 1) Absolute maximum ratings  
Operating the IC over the absolute maximum ratings may damage the IC. The damage can either be a short circuit between pins or an open circuit between pins. Therefore, it is important to consider circuit protection measures, such as adding a fuse, in case the IC is operated over the absolute maximum ratings.
- 2) Ground Voltage  
The voltage of the ground pin must be the lowest voltage of all pins of the IC at all operating conditions. Ensure that no pins are at a voltage below the ground pin at any time, even during transient condition.
- 3) Recommended operating conditions  
These conditions represent a range within which the expected characteristics of the IC can be approximately obtained. The electrical characteristics are guaranteed under the conditions of each parameter.
- 4) Bypass Capacitor for Noise Rejection  
To help reject noise, put a 1 $\mu$ F capacitor between V<sub>DD</sub> pin and GND and 100pF capacitor between V<sub>OUT</sub> pin and GND. Be careful when using extremely big capacitor as transient response will be affected.
- 5) Short between pins and mounting errors  
Be careful when mounting the IC on printed circuit boards. The IC may be damaged if it is mounted in a wrong orientation or if pins are shorted together. Short circuit may be caused by conductive particles caught between the pins.
- 6) Operation under strong electromagnetic field  
Operating the IC in the presence of a strong electromagnetic field may cause the IC to malfunction.
- 7) The V<sub>DD</sub> line impedance might cause oscillation because of the detection current.
- 8) A V<sub>DD</sub> to GND capacitor (as close connection as possible) should be used in high V<sub>DD</sub> line impedance condition.
- 9) Lower than the minimum input voltage puts the V<sub>OUT</sub> in high impedance state, and it must be V<sub>DD</sub> in pull up (V<sub>DD</sub>) condition.
- 10) External parameters  
The recommended value of R<sub>L</sub> Resistor is 50k $\Omega$  to 1M $\Omega$ . The recommended value of C<sub>T</sub> Capacitor is over 100pF to 0.1 $\mu$ F. There are many factors (board layout, etc) that can affect characteristics. Please verify and confirm using practical applications.
- 11) Power on reset operation  
Please note that the power on reset output varies with the V<sub>DD</sub> rise time. Please verify the behavior in the actual operation.
- 12) Testing on application boards  
When testing the IC on an application board, connecting a capacitor directly to a low-impedance output pin may subject the IC to stress. Always discharge capacitors completely after each process or step. The IC's power supply should always be turned off completely before connecting or removing it from the test setup during the inspection process. To prevent damage from static discharge, ground the IC during assembly and use similar precautions during transport and storage.
- 13) Rush current  
When power is first supplied to the IC, rush current may flow instantaneously. It is possible that the charge current to the parasitic capacitance of internal photo diode or the internal logic may be unstable. Therefore, give special consideration to power coupling capacitance, power wiring, width of GND wiring, and routing of connections.
- 14) C<sub>T</sub> pin discharge  
Due to the capabilities of the C<sub>T</sub> pin discharge transistor, the C<sub>T</sub> pin may not completely discharge when a short input pulse is applied, and in this case the delay time may not be controlled. Please verify the actual operation.

# Notice

## Precaution on using ROHM Products

- Our Products are designed and manufactured for application in ordinary electronic equipments (such as AV equipment, OA equipment, telecommunication equipment, home electronic appliances, amusement equipment, etc.). If you intend to use our Products in devices requiring extremely high reliability (such as medical equipment <sup>(Note 1)</sup>, transport equipment, traffic equipment, aircraft/spacecraft, nuclear power controllers, fuel controllers, car equipment including car accessories, safety devices, etc.) and whose malfunction or failure may cause loss of human life, bodily injury or serious damage to property ("Specific Applications"), please consult with the ROHM sales representative in advance. Unless otherwise agreed in writing by ROHM in advance, ROHM shall not be in any way responsible or liable for any damages, expenses or losses incurred by you or third parties arising from the use of any ROHM's Products for Specific Applications.

(Note1) Medical Equipment Classification of the Specific Applications

JAPAN	USA	EU	CHINA
CLASS III	CLASS III	CLASS II b	CLASS III
CLASS IV		CLASS III	

- ROHM designs and manufactures its Products subject to strict quality control system. However, semiconductor products can fail or malfunction at a certain rate. Please be sure to implement, at your own responsibilities, adequate safety measures including but not limited to fail-safe design against the physical injury, damage to any property, which a failure or malfunction of our Products may cause. The following are examples of safety measures:
  - Installation of protection circuits or other protective devices to improve system safety
  - Installation of redundant circuits to reduce the impact of single or multiple circuit failure
- Our Products are designed and manufactured for use under standard conditions and not under any special or extraordinary environments or conditions, as exemplified below. Accordingly, ROHM shall not be in any way responsible or liable for any damages, expenses or losses arising from the use of any ROHM's Products under any special or extraordinary environments or conditions. If you intend to use our Products under any special or extraordinary environments or conditions (as exemplified below), your independent verification and confirmation of product performance, reliability, etc. prior to use, must be necessary:
  - Use of our Products in any types of liquid, including water, oils, chemicals, and organic solvents
  - Use of our Products outdoors or in places where the Products are exposed to direct sunlight or dust
  - Use of our Products in places where the Products are exposed to sea wind or corrosive gases, including Cl<sub>2</sub>, H<sub>2</sub>S, NH<sub>3</sub>, SO<sub>2</sub>, and NO<sub>2</sub>
  - Use of our Products in places where the Products are exposed to static electricity or electromagnetic waves
  - Use of our Products in proximity to heat-producing components, plastic cords, or other flammable items
  - Sealing or coating our Products with resin or other coating materials
  - Use of our Products without cleaning residue of flux (even if you use no-clean type fluxes, cleaning residue of flux is recommended); or Washing our Products by using water or water-soluble cleaning agents for cleaning residue after soldering
  - Use of the Products in places subject to dew condensation
- The Products are not subject to radiation-proof design.
- Please verify and confirm characteristics of the final or mounted products in using the Products.
- In particular, if a transient load (a large amount of load applied in a short period of time, such as pulse. is applied, confirmation of performance characteristics after on-board mounting is strongly recommended. Avoid applying power exceeding normal rated power; exceeding the power rating under steady-state loading condition may negatively affect product performance and reliability.
- De-rate Power Dissipation (Pd) depending on Ambient temperature (Ta). When used in sealed area, confirm the actual ambient temperature.
- Confirm that operation temperature is within the specified range described in the product specification.
- ROHM shall not be in any way responsible or liable for failure induced under deviant condition from what is defined in this document.

## Precaution for Mounting / Circuit board design

- When a highly active halogenous (chlorine, bromine, etc.) flux is used, the residue of flux may negatively affect product performance and reliability.
- In principle, the reflow soldering method must be used; if flow soldering method is preferred, please consult with the ROHM representative in advance.

For details, please refer to ROHM Mounting specification

### Precautions Regarding Application Examples and External Circuits

1. If change is made to the constant of an external circuit, please allow a sufficient margin considering variations of the characteristics of the Products and external components, including transient characteristics, as well as static characteristics.
2. You agree that application notes, reference designs, and associated data and information contained in this document are presented only as guidance for Products use. Therefore, in case you use such information, you are solely responsible for it and you must exercise your own independent verification and judgment in the use of such information contained in this document. ROHM shall not be in any way responsible or liable for any damages, expenses or losses incurred by you or third parties arising from the use of such information.

### Precaution for Electrostatic

This Product is electrostatic sensitive product, which may be damaged due to electrostatic discharge. Please take proper caution in your manufacturing process and storage so that voltage exceeding the Products maximum rating will not be applied to Products. Please take special care under dry condition (e.g. Grounding of human body / equipment / solder iron, isolation from charged objects, setting of Ionizer, friction prevention and temperature / humidity control).

### Precaution for Storage / Transportation

1. Product performance and soldered connections may deteriorate if the Products are stored in the places where:
  - [a] the Products are exposed to sea winds or corrosive gases, including Cl<sub>2</sub>, H<sub>2</sub>S, NH<sub>3</sub>, SO<sub>2</sub>, and NO<sub>2</sub>
  - [b] the temperature or humidity exceeds those recommended by ROHM
  - [c] the Products are exposed to direct sunshine or condensation
  - [d] the Products are exposed to high Electrostatic
2. Even under ROHM recommended storage condition, solderability of products out of recommended storage time period may be degraded. It is strongly recommended to confirm solderability before using Products of which storage time is exceeding the recommended storage time period.
3. Store / transport cartons in the correct direction, which is indicated on a carton with a symbol. Otherwise bent leads may occur due to excessive stress applied when dropping of a carton.
4. Use Products within the specified time after opening a humidity barrier bag. Baking is required before using Products of which storage time is exceeding the recommended storage time period.

### Precaution for Product Label

QR code printed on ROHM Products label is for ROHM's internal use only.

### Precaution for Disposition

When disposing Products please dispose them properly using an authorized industry waste company.

### Precaution for Foreign Exchange and Foreign Trade act

Since our Products might fall under controlled goods prescribed by the applicable foreign exchange and foreign trade act, please consult with ROHM representative in case of export.

### Precaution Regarding Intellectual Property Rights

1. All information and data including but not limited to application example contained in this document is for reference only. ROHM does not warrant that foregoing information or data will not infringe any intellectual property rights or any other rights of any third party regarding such information or data. ROHM shall not be in any way responsible or liable for infringement of any intellectual property rights or other damages arising from use of such information or data.:
2. No license, expressly or implied, is granted hereby under any intellectual property rights or other rights of ROHM or any third parties with respect to the information contained in this document.

### Other Precaution

1. This document may not be reprinted or reproduced, in whole or in part, without prior written consent of ROHM.
2. The Products may not be disassembled, converted, modified, reproduced or otherwise changed without prior written consent of ROHM.
3. In no event shall you use in any way whatsoever the Products and the related technical information contained in the Products or this document for any military purposes, including but not limited to, the development of mass-destruction weapons.
4. The proper names of companies or products described in this document are trademarks or registered trademarks of ROHM, its affiliated companies or third parties.

**General Precaution**

1. Before you use our Products, you are requested to carefully read this document and fully understand its contents. ROHM shall not be in any way responsible or liable for failure, malfunction or accident arising from the use of any ROHM's Products against warning, caution or note contained in this document.
2. All information contained in this document is current as of the issuing date and subject to change without any prior notice. Before purchasing or using ROHM's Products, please confirm the latest information with a ROHM sales representative.
3. The information contained in this document is provided on an "as is" basis and ROHM does not warrant that all information contained in this document is accurate and/or error-free. ROHM shall not be in any way responsible or liable for any damages, expenses or losses incurred by you or third parties resulting from inaccuracy or errors of or concerning such information.





Компания «ЭлектроПласт» предлагает заключение долгосрочных отношений при поставках импортных электронных компонентов на взаимовыгодных условиях!

Наши преимущества:

- Оперативные поставки широкого спектра электронных компонентов отечественного и импортного производства напрямую от производителей и с крупнейших мировых складов;
- Поставка более 17-ти миллионов наименований электронных компонентов;
- Поставка сложных, дефицитных, либо снятых с производства позиций;
- Оперативные сроки поставки под заказ (от 5 рабочих дней);
- Экспресс доставка в любую точку России;
- Техническая поддержка проекта, помощь в подборе аналогов, поставка прототипов;
- Система менеджмента качества сертифицирована по Международному стандарту ISO 9001;
- Лицензия ФСБ на осуществление работ с использованием сведений, составляющих государственную тайну;
- Поставка специализированных компонентов (Xilinx, Altera, Analog Devices, Intersil, Interpoint, Microsemi, Aeroflex, Peregrine, Syfer, Eurofarad, Texas Instrument, Miteq, Cobham, E2V, MA-COM, Hittite, Mini-Circuits, General Dynamics и др.);

Помимо этого, одним из направлений компании «ЭлектроПласт» является направление «Источники питания». Мы предлагаем Вам помощь Конструкторского отдела:

- Подбор оптимального решения, техническое обоснование при выборе компонента;
- Подбор аналогов;
- Консультации по применению компонента;
- Поставка образцов и прототипов;
- Техническая поддержка проекта;
- Защита от снятия компонента с производства.



#### Как с нами связаться

**Телефон:** 8 (812) 309 58 32 (многоканальный)

**Факс:** 8 (812) 320-02-42

**Электронная почта:** [org@eplast1.ru](mailto:org@eplast1.ru)

**Адрес:** 198099, г. Санкт-Петербург, ул. Калинина, дом 2, корпус 4, литера А.