

# Features

## Regulated Converters

- High 4kVDC & 6kVDC Isolation
- 5W DIP24 Industry Standard Package
- Feedback Regulated Output
- Continuous Short Circuit Protection
- Wide Inputs 2:1 & 4:1
- Approved for Medical Applications
- UL and EN Safety Approvals
- 2 Pinout Options, 3 Case Styles
- Efficiency to 86 %

### Description

This series offers standard isolation of 2kVDC with 4kVDC or 6kVDC options making it ideal for both industrial, medical and other sophisticated high end applications. Packaging can be either DIP-24 non-conductive plastic or 5-side-shielded DIP24 metal case (= option "/M") as well as DIP24-SMD case (= option "/SMD"). For all the above variants, 2 industry-standard pinouts (= option "/A" or "/C") are available. "B" pinning is also available with "/H" isolation of 1.6kVDC. Remote on/off control is possible with the /CTRL option ("A" pinning only). The converters can deliver 140% rated power for short periods of time to cope with applications with large capacitive loads or high start up currents.

### Selection Guide

| Part Number<br>DIP24 (SMD) | Input Voltage (VDC)      | Output Voltage (VDC) | Output Current (mA) | Efficiency (%) | Max Capacitive Load <sup>(1)</sup> |
|----------------------------|--------------------------|----------------------|---------------------|----------------|------------------------------------|
| REC5-xx3.3SRW/H*           | 9 - 18, 18 - 36, 36 - 72 | 3.3                  | 1000                | 75-77          | 6800µF                             |
| REC5-xx05SRW/H*            | 9 - 18, 18 - 36, 36 - 72 | 5                    | 1000                | 79-81          | 6800µF                             |
|                            | 4.5 - 9V                 |                      |                     | 72             |                                    |
| REC5-xx09SRW/H*            | 9 - 18, 18 - 36, 36 - 72 | 9                    | 556                 | 82-83          | 6800µF                             |
|                            | 4.5 - 9V                 |                      |                     | 73             |                                    |
| REC5-xx12SRW/H*            | 9 - 18, 18 - 36, 36 - 72 | 12                   | 420                 | 84-85          | 6800µF                             |
|                            | 4.5 - 9V                 |                      |                     | 74             |                                    |
| REC5-xx15SRW/H*            | 9 - 18, 18 - 36, 36 - 72 | 15                   | 340                 | 85-86          | 6800µF                             |
|                            | 4.5 - 9V                 |                      |                     | 75             |                                    |
| REC5-xx05DRW/H*            | 9 - 18, 18 - 36, 36 - 72 | ±5                   | ±500                | 79-81          | ±2200µF                            |
|                            | 4.5 - 9V                 |                      |                     | 72             |                                    |
| REC5-xx09DRW/H*            | 9 - 18, 18 - 36, 36 - 72 | ±9                   | ±278                | 82-84          | ±2200µF                            |
|                            | 4.5 - 9V                 |                      |                     | 74             |                                    |
| REC5-xx12DRW/H*            | 9 - 18, 18 - 36, 36 - 72 | ±12                  | ±210                | 84-85          | ±2200µF                            |
|                            | 4.5 - 9V                 |                      |                     | 75             |                                    |
| REC5-xx15DRW/H*            | 9 - 18, 18 - 36, 36 - 72 | ±15                  | ±170                | 85-86          | ±2200µF                            |
|                            | 4.5 - 9V                 |                      |                     | 75             |                                    |
| REC5-xx3.3SRWZ/H*          | 9 - 36**, 18 - 72        | 3.3                  | 1000                | 75-76          | 6800µF                             |
| REC5-xx05SRWZ /H*          | 9 - 36**, 18 - 72        | 5                    | 1000                | 81-82          | 6800µF                             |
| REC5-xx09SRWZ/H*           | 9 - 36, 18 - 72          | 9                    | 556                 | 82-83          | 6800µF                             |
| REC5-xx12SRWZ /H*          | 9 - 36, 18 - 72          | 12                   | 420                 | 83-84          | 6800µF                             |
| REC5-xx15SRWZ/H*           | 9 - 36, 18 - 72          | 15                   | 340                 | 84-85          | 6800µF                             |
| REC5-xx05DRWZ/H*           | 9 - 36**, 18 - 72        | ±5                   | ±500                | 81-82          | ±2200µF                            |
| REC5-xx09DRWZ/H*           | 9 - 36, 18 - 72          | ±9                   | ±278                | 82-84          | ±2200µF                            |
| REC5-xx12DRWZ /H*          | 9 - 36, 18 - 72          | ±12                  | ±210                | 82-83          | ±2200µF                            |
| REC5-xx15DRWZ /H*          | 9 - 36, 18 - 72          | ±15                  | ±170                | 84-85          | ±2200µF                            |

H\* = H2, H4 or H6 for A or C pinning options with 2kVDC, 4kVDC or 6kVDC isolation.

H\* = H for B pinning option with 1.6kVDC isolation only. \*\* Derate to 900mA (±450mA) max. at Vin=9V

\* add suffix "/A", "/A/X2", "/B" or "/C" for pinning options, see next page and Isolation Restrictions.

\* add suffix "/M" for metal case.

\* add suffix "/SMD" for SMD package.

\* add suffix "/CTRL" for control pin option (A Pinning only)

\* add suffix -R for Tape and Reel packaging

#### 2:1 Input

(REC5-S/DRW)

xx = 4.5-9Vin = 05

xx = 9-18Vin = 12

xx = 18-36Vin = 24

xx = 36-72Vin = 48

#### 4:1 Input

(REC5-S/DRWZ)

xx = 9-36Vin = 24

xx = 18-72Vin = 48

## ECONOLINE

DC/DC-Converter

with 3 year Warranty

# RECOM

## 5 Watt DIP24 & SMD Single & Dual Output



**EN-60950-1 Certified**  
**UL-60950-1 Certified**  
**EN-60601-1 Certified**

## REC 5

## Derating-Graph (Ambient Temperature)



Refer to Application Notes

## Specifications (measured at $T_A = 25^\circ\text{C}$ , nominal input voltage, full load and after warm-up)

|   |  |   |   |
|---|--|---|---|
| Input Voltage Range   |  |   | 2:1 & 4:1   |
| Output Voltage Accuracy   |  |   | $\pm 2\%$ max.  |
| Line Regulation (HL-LL)   |  |   | $\pm 0.3\%$ max.  |
| Load Regulation (for output load current change from 20% to 100%)           |  |   | $\pm 0.6\%$ max.  |
| Minimum Load  |  |   | 10% <sup>(2)</sup>  |
| Output Ripple and Noise (0,1 $\mu\text{F}$ capacitor on output, 20MHz BW)   |  |   | 50mVp-p max.  |
| Operating Frequency at Full Load  | 2:1 input  |   | 120kHz typ.   |
| (at nominal input voltage)  | 4:1 input  |   | 200kHz typ.   |
| Input Filter  |  |   | Pi Network  |
| Efficiency at Full Load   |  |   | see above   |
| No Load Power Consumption   |  |   | 300mW max.  |
| Isolation Voltage   | H2-Suffix  | (tested for 1 second)<br>(rated for 1 minute**) | 2000VDC<br>1000VAC / 60Hz   |
| Isolation Voltage   | H4-Suffix  | (tested for 1 second)<br>(rated for 1 minute**) | 4000VDC<br>2000VAC / 60Hz   |
| Isolation Voltage   | H6-Suffix  | (tested for 1 second)<br>(rated for 1 minute**) | 6000VDC<br>3000VAC / 60Hz   |
| Isolation Capacitance   |  |   | 60pF typ.   |
| Isolation Resistance  |  |   | 1 G $\Omega$ min.   |
| Short Circuit Protection (Max temp. = 50°C during short circuit conditions) |  |   | Continuous, Auto Restart  |
| Operating Temperature (free air convection)                                 |  |   | -40°C to +75°C (see Graph)  |
| Storage Temperature Range   |  |   | -55°C to +125°C   |
| Relative Humidity   |  |   | 95% RH  |
| Case Material   |  |   | Non-Conductive Plastic or Metal                                       |
| Thermal Impedance   | Natural convection   |   | 20°C/W for plastic case<br>12°C/W for metal case                      |
| Package Weight  |  |   | 13g   |
| Packing Quantity  |  |   | 15 pcs per Tube<br>100 pcs per Reel                                   |
| MTBF (+25°C)  | Detailed Information see<br>Application Notes chapter "MTBF" | using MIL-HDBK 217F                             | 850 x 10 <sup>3</sup> hours   |
| (+75°C)   |  | using MIL-HDBK 217F                             | 206 x 10 <sup>3</sup> hours   |
| Certifications  |  |   |   |
| UL General Safety   | Report: E358085  |   | UL 60950-1 1st Ed.<br>C22.2 No. 60950-1-03                            |
| EN General Safety   | Report: SPLVD1212007   | EN60950-1:2006 + 9+A1:2010+A12:2011             |   |
| EN Medical Safety   | Report: MDD1205098-3 + RM1205098-3                           |   | IEC/EN 60601-1 3rd Edition, Medical Report + ISO14971 Risk Assessment |

## Isolation Restrictions

"B" Pinning is restricted to 1.6kV isolation due to the closeness of the input and output pins.

If the options "/M" for metal case and "/SMD" for SMD pinout are combined, the maximum allowed isolation voltage is 2kVDC because of the shorter distances between pins and the metal case.

DIP-24 through-hole case and SMD-plastic case are not affected and offer the full isolation barriers of 2kV through to 6kVDC.

## Ordering Examples:

REC5-0512DRW/H2/A/CTRL= 2:1 input, 5V Vin,  $\pm 12\text{V}$  Vout, 2kVDC, pinout "A", plastic case, control pin

REC5-4812SRWZ/H4/A/M = 4:1 input, 48V Vin, 12V Vout, 4kVDC, pinout "A", metal case, no control pin

REC5-1212DRWZ/H/B = 4:1 input, 12V Vin,  $\pm 12\text{V}$  Vout, 1.6kVDC, pinout "B", plastic case, no control pin

REC5-0505SRW/H6/C/SMD = 2:1 input, 5V Vin, 5V Vout, 6kVDC, SMD pinout "C", plastic case, no control pin

\*\*Any data referred to in this datasheet are of indicative nature and based on our practical experience only. For further details, please refer to our Application Notes.

## Notes

Note 1: Maximum capacitive load is defined as the capacitive load that will allow start up in under 1 second without damage to the converter.

Note 2: The REC 5 series requires a minimum of 10% load on the output to maintain specified regulation. Operating under no-load conditions will not damage these devices; however, they may not meet all listed specifications.

## Typical Characteristics

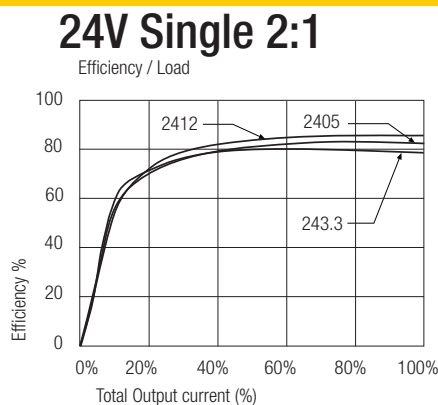
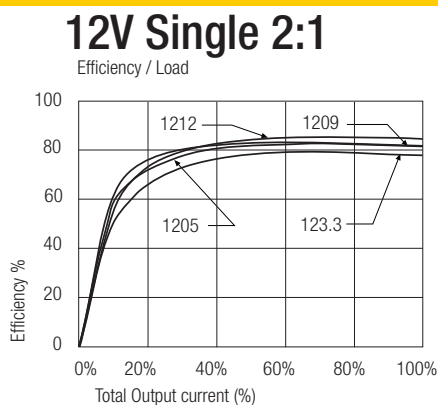

Typical Characteristics

### 48V Single 2:1

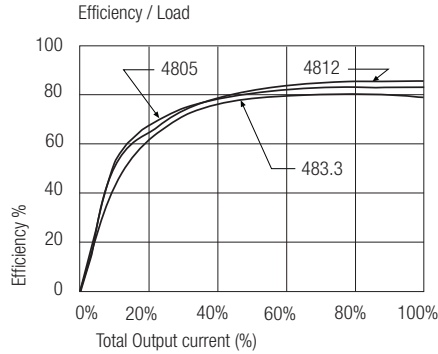

### Dual 4:1

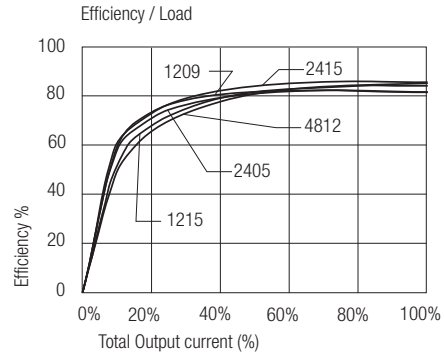

Package Style and Pinning (mm) DIP 24 , Wide Input 2:1 & 4:1

**"A" Pinning**  
/H2, /H4 & /H6

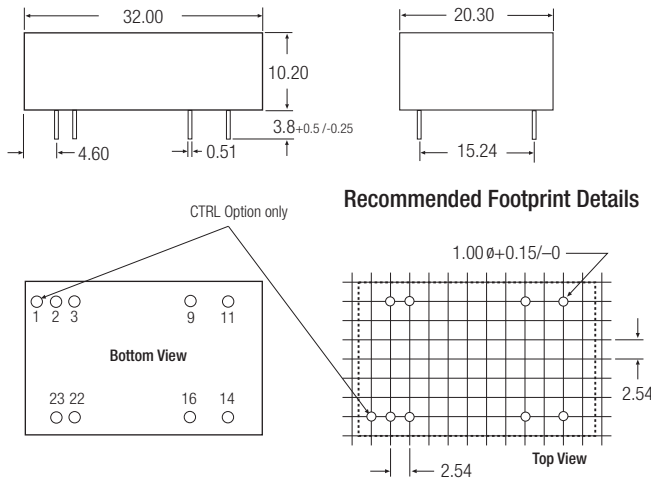

Pin Connections

| Pin #      | Single | Single/X2 | Dual  |
|------------|--------|-----------|-------|
| 1 (option) | CTRL   | CTRL      | CTRL  |
| 2          | -Vin   | -Vin      | -Vin  |
| 3          | -Vin   | -Vin      | -Vin  |
| 9          | NC     | No Pin    | Com   |
| 11         | NC     | NC        | -Vout |
| 14         | +Vout  | +Vout     | +Vout |
| 16         | -Vout  | -Vout     | Com   |
| 22         | +Vin   | +Vin      | +Vin  |
| 23         | +Vin   | +Vin      | +Vin  |

NC = No Connection  
XX.X ± 0.5 mm  
XX.XX ± 0.25 mm

**CTRL Option**

ON = Open or  $0V < V_{ctrl} < 1.2V$   
OFF =  $2.2V < V_{ctrl} < 12V$

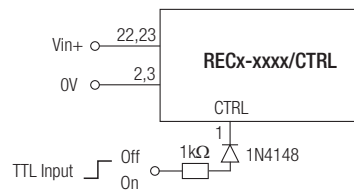

**"C" Pinning**  
/H2, /H4 & /H6



Pin Connections

| Pin # | Single | Dual  |
|-------|--------|-------|
| 1     | +Vin   | +Vin  |
| 2     | +Vin   | +Vin  |
| 10    | NC     | Com   |
| 11    | NC     | Com   |
| 12    | -Vout  | NC    |
| 13    | +Vout  | -Vout |
| 15    | NC     | +Vout |
| 23    | -Vin   | -Vin  |
| 24    | -Vin   | -Vin  |

XX.X ± 0.5 mm  
XX.XX ± 0.25 mm

Package Style and Pinning (mm) DIP 24 , Wide Input 2:1 & 4:1

### "B" Pinning /H (1.6kV Only)



#### Recommended Footprint Details

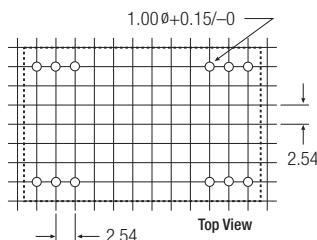
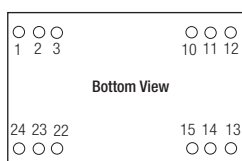

#### Pin Connections

| Pin # | Single | Dual  |
|-------|--------|-------|
| 1     | +Vin   | +Vin  |
| 2     | No Pin | -Vout |
| 3     | No Pin | Com   |
| 10    | -Vout  | Com   |
| 11    | +Vout  | +Vout |
| 12    | -Vin   | -Vin  |
| 13    | -Vin   | -Vin  |
| 14    | +Vout  | +Vout |
| 15    | -Vout  | Com   |
| 22    | No Pin | Com   |
| 23    | No Pin | -Vout |
| 24    | +Vin   | +Vin  |

NC = No Connection

XX.X ± 0.5 mm

XX.XX ± 0.25 mm

### SMD Pinning



#### Recommended Footprint Details



SMD pin connections follow standard package A (/A/SMD), B (/B/SMD) or C (/C/SMD) pinning.

All unused pins are NC (No Connection). See Below for detailed pinout lists

for all packages incl.SMD case the length of plastic case is 31,8 mm, length of metal case 32.0 mm

### /A/SMD Pinning

### /B/SMD Pinning

### /C/SMD Pinning

| Pin Connections |        |       | Pin Connections |        |       | Pin Connections |        |       | Pin Connections |        |       | Pin Connections |        |      | Pin Connections |        |       |
|-----------------|--------|-------|-----------------|--------|-------|-----------------|--------|-------|-----------------|--------|-------|-----------------|--------|------|-----------------|--------|-------|
| Pin #           | Single | Dual  | Pin #           | Single | Dual  | Pin #           | Single | Dual  | Pin #           | Single | Dual  | Pin #           | Single | Dual | Pin #           | Single | Dual  |
| 1 (Option)      | CTRL   | CTRL  | 13              | NC     | NC    | 1               | +Vin   | +Vin  | 13              | -Vin   | -Vin  | 1               | +Vin   | +Vin | 13              | +Vout  | -Vout |
| 2               | -Vin   | -Vin  | 14              | +Vout  | +Vout | 2               | NC     | -Vout | 14              | +Vout  | +Vout | 2               | +Vin   | +Vin | 14              | NC     | NC    |
| 3               | -Vin   | -Vin  | 15              | NC     | NC    | 3               | NC     | Com   | 15              | -Vout  | Com   | 3               | NC     | NC   | 15              | NC     | +Vout |
| 4               | NC     | NC    | 16              | -Vout  | Com   | 4               | NC     | NC    | 16              | NC     | NC    | 4               | NC     | NC   | 16              | NC     | NC    |
| 5               | NC     | NC    | 20              | NC     | NC    | 5               | NC     | NC    | 20              | NC     | NC    | 5               | NC     | NC   | 20              | NC     | NC    |
| 9               | NC     | Com   | 21              | NC     | NC    | 9               | NC     | NC    | 21              | NC     | NC    | 9               | NC     | NC   | 21              | NC     | NC    |
| 10              | NC     | NC    | 22              | +Vin   | +Vin  | 10              | -Vout  | Com   | 22              | NC     | Com   | 10              | NC     | Com  | 22              | NC     | NC    |
| 11              | NC     | -Vout | 23              | +Vin   | +Vin  | 11              | +Vout  | +Vout | 23              | NC     | -Vout | 11              | NC     | Com  | 23              | -Vin   | -Vin  |
| 12              | NC     | NC    | 24              | NC     | NC    | 12              | -Vin   | -Vin  | 24              | +Vin   | +Vin  | 12              | -Vout  | NC   | 24              | -Vin   | -Vin  |



Компания «ЭлектроПласт» предлагает заключение долгосрочных отношений при поставках импортных электронных компонентов на взаимовыгодных условиях!

Наши преимущества:

- Оперативные поставки широкого спектра электронных компонентов отечественного и импортного производства напрямую от производителей и с крупнейших мировых складов;
- Поставка более 17-ти миллионов наименований электронных компонентов;
- Поставка сложных, дефицитных, либо снятых с производства позиций;
- Оперативные сроки поставки под заказ (от 5 рабочих дней);
- Экспресс доставка в любую точку России;
- Техническая поддержка проекта, помощь в подборе аналогов, поставка прототипов;
- Система менеджмента качества сертифицирована по Международному стандарту ISO 9001;
- Лицензия ФСБ на осуществление работ с использованием сведений, составляющих государственную тайну;
- Поставка специализированных компонентов (Xilinx, Altera, Analog Devices, Intersil, Interpoint, Microsemi, Aeroflex, Peregrine, Syfer, Eurofarad, Texas Instrument, Miteq, Cobham, E2V, MA-COM, Hittite, Mini-Circuits, General Dynamics и др.);

Помимо этого, одним из направлений компании «ЭлектроПласт» является направление «Источники питания». Мы предлагаем Вам помощь Конструкторского отдела:

- Подбор оптимального решения, техническое обоснование при выборе компонента;
- Подбор аналогов;
- Консультации по применению компонента;
- Поставка образцов и прототипов;
- Техническая поддержка проекта;
- Защита от снятия компонента с производства.



#### Как с нами связаться

**Телефон:** 8 (812) 309 58 32 (многоканальный)

**Факс:** 8 (812) 320-02-42

**Электронная почта:** [org@eplast1.ru](mailto:org@eplast1.ru)

**Адрес:** 198099, г. Санкт-Петербург, ул. Калинина, дом 2, корпус 4, литера А.