

ES Series Sealed Tiny Slide Switches

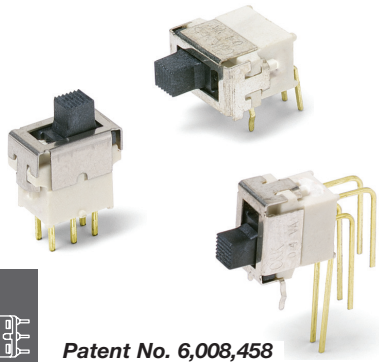

Patent No. 6,008,458

Features/Benefits

- Process compatible—internal o-ring and epoxy base seal
- Thru-hole & surface mount models
- Reliable contact design ensures long electrical life
- Robust actuator for easy actuation
- RoHS compliant

Typical Applications

- Computer peripherals & network products
- Test & measurement equipment
- Telephone & cable modems

Slide

Specifications

CONTACT RATING: 0.4 VA max. @ 20 V AC or DC max.
 MECHANICAL & ELECTRICAL LIFE: 40,000 make-and-break cycles at full load.
 CONTACT RESISTANCE: 50 m Ω max. initial @ 2-4 V DC, 100 mA.
 INSULATION RESISTANCE: 10⁹ Ω min.
 DIELECTRIC STRENGTH: 500 Vrms min.
 OPERATING TEMPERATURE: -30°C to 85°C.
 SOLDERABILITY: Per MIL-STD-202F method 208D, or EIA RS-186E method 9.
 DEGREE OF PROTECTION: IP57; Protection against harmful dust deposit, full-scale voltage protection, temporary immersion.
 ESD ENDURANCE: 8kv min. (EIA 545).
 PACKAGING: Thru-hole switches supplied in anti-static trays. Surface mount switches available in tape and reel packaging.

Materials

HOUSING & BASE: Nylon (UL 94V-0).
 ACTUATOR: LCP (UL 94V-0) black, standard.
 SURFACE PLATE: Stainless steel with tin plate.
 MOVABLE CONTACT: Bronze with gold plate over nickel plate.
 STATIONARY CONTACTS: Copper alloy, with gold plate over nickel plate.
 TERMINALS: Copper alloy, with gold over nickel plate. All terminals insert molded.
 BASE & TERMINAL SEAL: Epoxy.

NOTE: All models RoHS compliant and compatible with all options.

NOTE: Specifications and materials listed above are for switches with standard options. For information on specific and custom switches, consult Customer Service Center.

How To Order

Complete part numbers for ES Series Sealed Tiny Slide Switches are shown on pages I-5 through I-7. These unique tiny slide switches are process compatible. An internal o-ring and epoxy base seal protects the switch from wave and reflow soldering, as well as cleaning processes.

PART NUMBER	SWITCH FUNCTION		
	POS. 1	POS. 2	POS. 3
ES01MCBE	ON	NONE	ON
ES03MCBE	ON	OFF	ON
CONN. TERMINALS	2-3	OPEN	2-1
SCHEMATIC SPDT			
ES02MCBE	OFF	NONE	ON
CONN. TERMINALS	OPEN	N/A	3-1
SCHEMATIC SPDT			

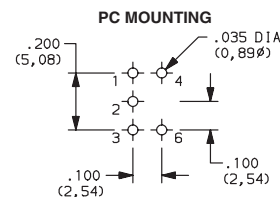
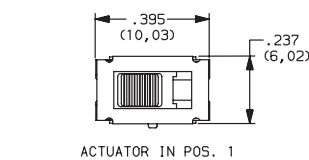

ES01MCBE
SPDT

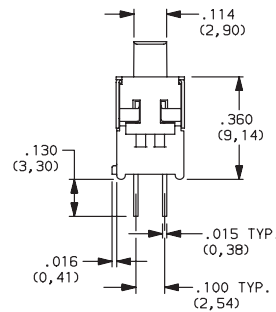
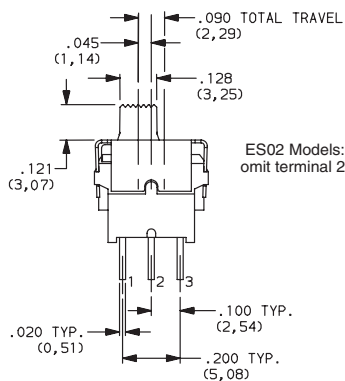

Third Angle Projection
 Dimensions are shown: Inch (mm)
 Specifications and dimensions subject to change



ES Series Sealed Tiny Slide Switches

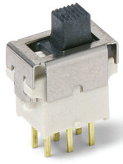

ES21MCBE
DPDT

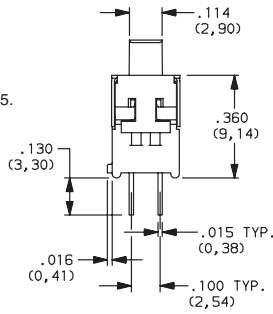
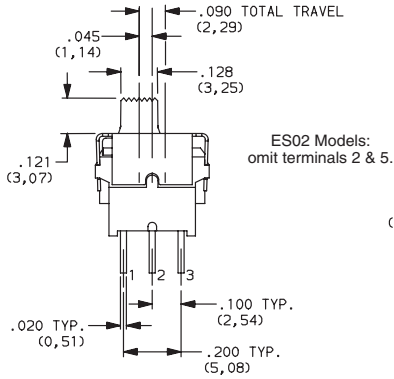
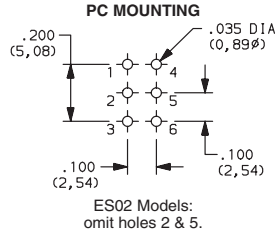
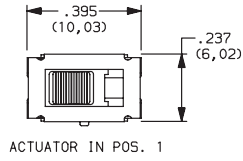

PART NUMBER	SWITCH FUNCTION		
	POS. 1	POS. 2	POS. 3
ES21MCBE	ON	NONE	ON
ES23MCBE	ON	OFF	ON
CONN. TERMINALS	2-3, 5-6	OPEN	2-1, 5-4
SCHEMATIC			
DPDT			
ES22MCBE	OFF	NONE	ON
CONN. TERMINALS	OPEN	N/A	3-1, 6-4
SCHEMATIC			
DPST			



Slide

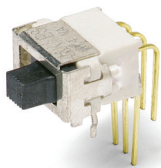

ES21MABE
DPDT

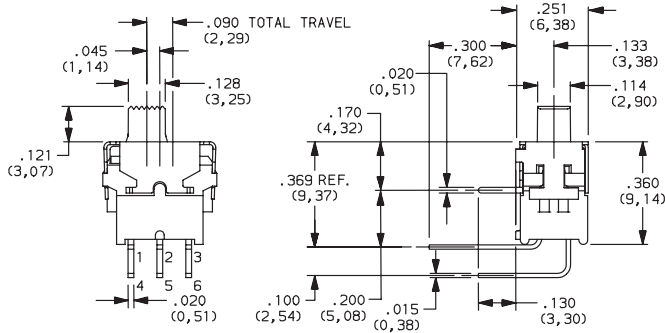
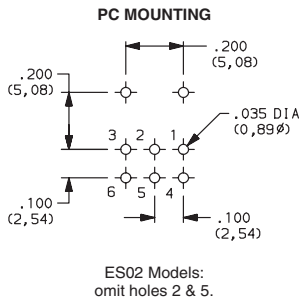
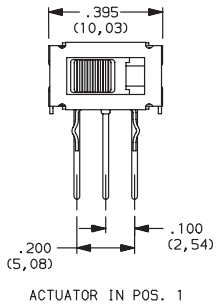

ES22 Models:
omit terminals 2 & 5.

PART NUMBER	SWITCH FUNCTION		
	POS. 1	POS. 2	POS. 3
ES21MABE	ON	NONE	ON
ES23MABE	ON	OFF	ON
CONN. TERMINALS	2-3, 5-6	OPEN	2-1, 5-4
SCHEMATIC			
DPDT			
ES22MABE	OFF	NONE	ON
CONN. TERMINALS	OPEN	N/A	3-1
SCHEMATIC			
DPST			



Third Angle
Projection
Dimensions are shown: Inches (mm)
Specifications and dimensions subject to change

ES Series Sealed Tiny Slide Switches

Slide

PART NUMBER	SWITCH FUNCTION		
	POS. 1	POS. 2	POS. 3
ES01MAVBE	ON	NONE	ON
ES03MAVBE	ON	OFF	ON
CONN. TERMINALS	2-3	OPEN	2-1
SCHEMATIC			

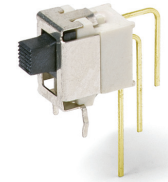
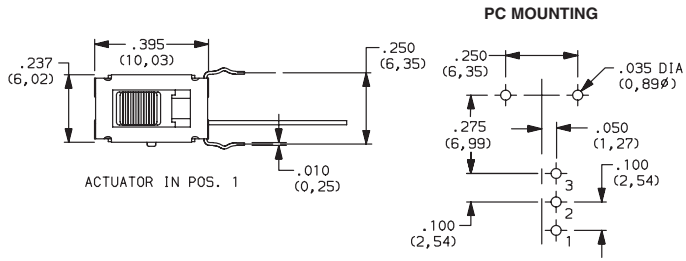

**ES01MAVBE
SPDT**

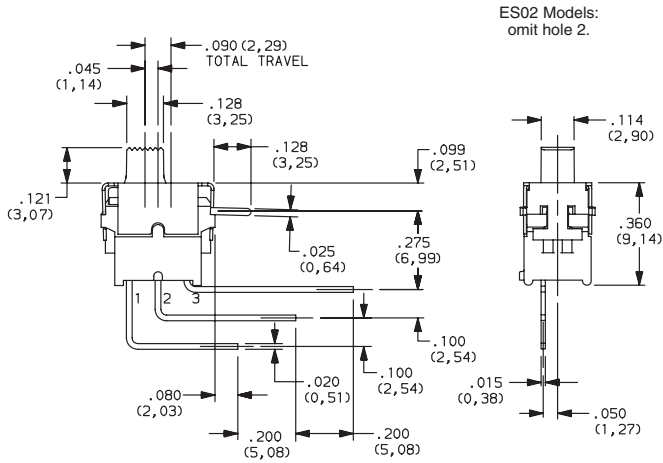

ES02 Models:
omit hole 2.

ES02 Models:
omit terminal 2.

PART NUMBER	SWITCH FUNCTION		
	POS. 1	POS. 2	POS. 3
ES01MSABE	ON	NONE	ON
ES03MSABE	ON	OFF	ON
CONN. TERMINALS	2-3	OPEN	2-1
SCHEMATIC			
SPDT			
ES02MSABE	OFF	NONE	ON
CONN. TERMINALS	OPEN	N/A	3-1
SCHEMATIC			
SPST			

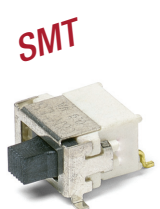
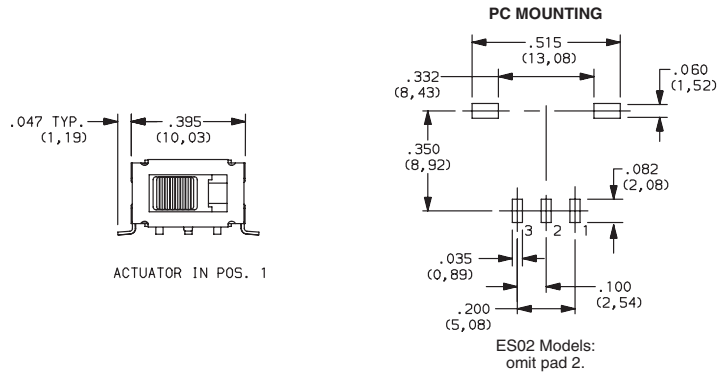

**ES01MSABE
Horizontal Actuation
SPDT**

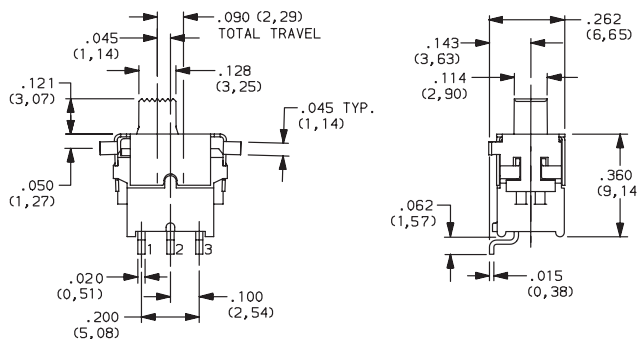

ES02 Models:
omit pad 2.

ES02 Models:
omit terminal 2.



Dimensions are shown: Inch (mm)

Specifications and dimensions subject to change



ES Series Sealed Tiny Slide Switches

TAPE & REEL

For part numbers ESXXMSABE

REEL INFORMATION	
OUTSIDE DIAMETER	13.00 (330,0)
PILOT HOLE	.512 (13,0)
QUANTITY PER REEL	300

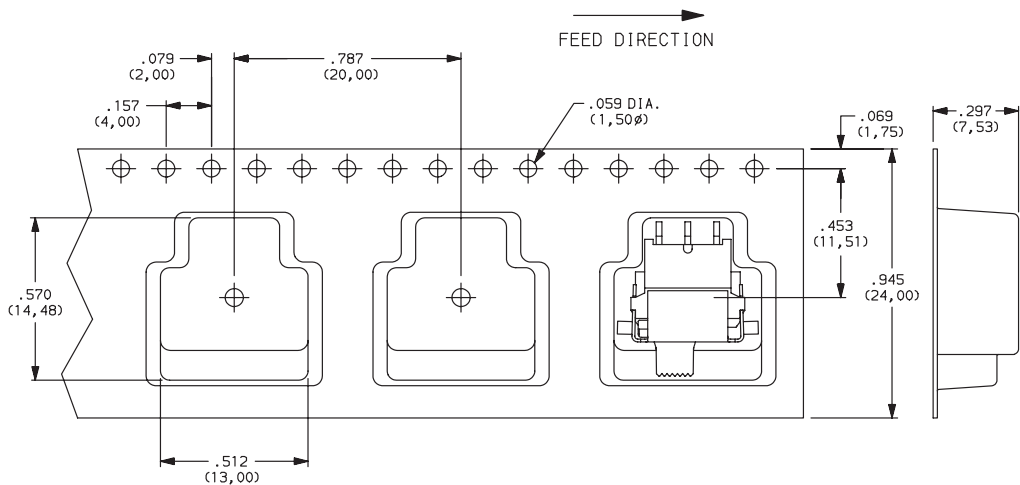



Компания «ЭлектроПласт» предлагает заключение долгосрочных отношений при поставках импортных электронных компонентов на взаимовыгодных условиях!

Наши преимущества:

- Оперативные поставки широкого спектра электронных компонентов отечественного и импортного производства напрямую от производителей и с крупнейших мировых складов;
- Поставка более 17-ти миллионов наименований электронных компонентов;
- Поставка сложных, дефицитных, либо снятых с производства позиций;
- Оперативные сроки поставки под заказ (от 5 рабочих дней);
- Экспресс доставка в любую точку России;
- Техническая поддержка проекта, помощь в подборе аналогов, поставка прототипов;
- Система менеджмента качества сертифицирована по Международному стандарту ISO 9001;
- Лицензия ФСБ на осуществление работ с использованием сведений, составляющих государственную тайну;
- Поставка специализированных компонентов (Xilinx, Altera, Analog Devices, Intersil, Interpoint, Microsemi, Aeroflex, Peregrine, Syfer, Eurofarad, Texas Instrument, Miteq, Cobham, E2V, MA-COM, Hittite, Mini-Circuits, General Dynamics и др.);

Помимо этого, одним из направлений компании «ЭлектроПласт» является направление «Источники питания». Мы предлагаем Вам помощь Конструкторского отдела:

- Подбор оптимального решения, техническое обоснование при выборе компонента;
- Подбор аналогов;
- Консультации по применению компонента;
- Поставка образцов и прототипов;
- Техническая поддержка проекта;
- Защита от снятия компонента с производства.



Как с нами связаться

Телефон: 8 (812) 309 58 32 (многоканальный)

Факс: 8 (812) 320-02-42

Электронная почта: org@eplast1.ru

Адрес: 198099, г. Санкт-Петербург, ул. Калинина, дом 2, корпус 4, литера А.