

Description

The F0424 is a 600MHz to 4200MHz SiGe High-Gain Broadband RF Amplifier. The combination of low noise figure (NF) and high linearity performance allows the device to be used in both receiver and transmitter applications.

The F0424 is designed to operate with a single 5V or 3.3V power supply using a nominal 70mA of I_{CC} . With a supply voltage of 5V, the F0424 provides 17.3dB gain with +40dBm OIP3 and 2.3dB noise figure at 2600MHz.

The device is packaged in a 2×2 mm, 8-pin Thin DFN with 50Ω single-ended RF input and output impedances for ease of integration into the signal path.

Competitive Advantage

- High Gain
- Broadband
- STBY Feature
- Superior Reliability versus GaAs

Typical Applications

- 4G TDD and FDD Base Stations
- 2G/3G Base Stations
- Repeaters and DAS
- Point-to-Point Infrastructure
- Public Safety Infrastructure
- Military Handhelds

Table 1. Typical Values

Part Number	Frequency (MHz)	Gain (dB)	NF (dB)	OIP3 (dBm)
F0424	600 to 4200	17.3	2.3	+40

Features

- RF Range: 600MHz to 4200MHz
- Noise Figure = 2.3dB at 2600MHz
- Gain = 17.3dB at 2600MHz
- OIP3 = +40dBm at 2600MHz
- Output P1dB = +21dBm at 2600MHz
- Near-Constant Gain versus Temperature
- 3.3V or 5V Power Supply
- $I_{CC} = 70$ mA
- 2mA Standby Current
- 350mW Typical DC Power at 5V Supply
- 50Ω Input and Output Impedances
- Operating Temperature (T_{EPAD}) Range: -40°C to $+105^{\circ}\text{C}$
- 2×2 mm, 8-DFN Package

Block Diagram

Figure 1. Block Diagram

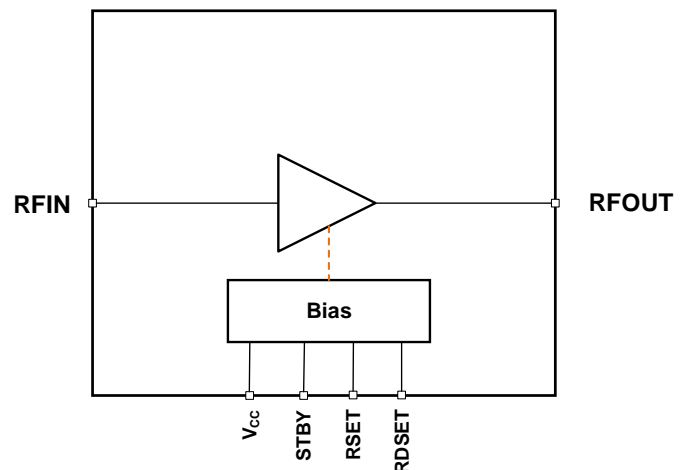

Contents

Description.....	1
Competitive Advantage	1
Typical Applications.....	1
Features	1
Block Diagram	1
Pin Assignments.....	5
Pin Descriptions.....	5
Absolute Maximum Ratings.....	6
Recommended Operating Conditions	6
Electrical Characteristics	7
Electrical Characteristics	8
Thermal Characteristics.....	9
Typical Operating Conditions (TOC)	9
Typical Performance Characteristics.....	10
Typical Performance Characteristics.....	11
Typical Performance Characteristics.....	12
Typical Performance Characteristics.....	13
Typical Performance Characteristics.....	14
Typical Performance Characteristics.....	15
Typical Application Circuit	16
Evaluation Kit Picture	17
Evaluation Kit / Applications Circuit.....	18
Applications Information	20
Power Supplies.....	20
Package Outline Drawings	21
Marking Diagram	21
Information.....	21
Revision History.....	22

Figures

Figure 1. Block Diagram	1
Figure 2. Pin Assignments for $2 \times 2 \times 0.75$ mm 8-DFN Package – Top View.....	5
Figure 3. Gain versus Temperature (5V Variation).....	10
Figure 4. Gain versus Temperature (3.3V Variation).....	10
Figure 5. Gain versus Bias Current (5.0V).....	10
Figure 6. Gain versus Bias Current (3.3V).....	10
Figure 7. Output IP3 versus Temperature (5V Variation, 70mA).....	10
Figure 8. Output IP3 versus Temperature (5V Variation, 80mA).....	10
Figure 9. Output IP3 versus Temperature (3.3V Variation, 70mA).....	11

Figure 10. Output IP3 versus Temperature (3.3V Variation, 40mA)	11
Figure 11. Output IP3 versus Bias Current (5.0V)	11
Figure 12. Output IP3 versus Bias Current (3.3V)	11
Figure 13. Output 1dB Compression versus Temperature (5V Variation, 70mA)	11
Figure 14. Output 1dB Compression versus Temperature (3.3V Variation, 70mA)	11
Figure 15. Gain Compression versus Temperature (5V, 0.7GHz, 70mA)	12
Figure 16. Phase Compression versus Temperature (5V, 0.7GHz, 70mA)	12
Figure 17. Gain Compression versus Temperature (5V, 1.9GHz, 70mA)	12
Figure 18. Phase Compression versus Temperature (5V, 1.9GHz, 70mA)	12
Figure 19. Gain Compression versus Temperature (5V, 2.6GHz, 70mA)	12
Figure 20. Phase Compression versus Temperature (5V, 2.6GHz, 70mA)	12
Figure 21. Gain Compression versus Temperature (5V, 3.5GHz, 70mA)	13
Figure 22. Phase Compression versus Temperature (5V, 3.5GHz, 70mA)	13
Figure 23. Gain Compression versus Temperature (5V, 4.1GHz, 70mA)	13
Figure 24. Phase Compression versus Temperature (5V, 4.1GHz, 70mA)	13
Figure 25. Gain Compression versus Temperature (3.3V, 2.6GHz, 70mA)	13
Figure 26. Phase Compression versus Temperature (3.3V, 2.6GHz, 70mA)	13
Figure 27. RFIN Return Loss versus Temperature (5V Variation)	14
Figure 28. RFIN Return Loss versus Temperature (3.3V Variation)	14
Figure 29. RFOUT Return Loss versus Temperature (5V Variation)	14
Figure 30. RFOUT Return Loss versus Temperature (3.3V Variation)	14
Figure 31. Reverse Gain versus Temperature (5V Variation)	14
Figure 32. Stability Factor for Various Currents (3.3V, 5.0V, -40°C, R8=1K)	14
Figure 33. Turn-on Time (3.3V)	15
Figure 34. Turn-on Time (5.0V)	15
Figure 35. Noise Figure versus Temperature (5.0V Variation)	15
Figure 36. Noise Figure versus Temperature (3.3V Variation)	15
Figure 37. Noise Figure versus Current (5.0V Variation)	15
Figure 38. Noise Figure versus Current (3.3V Variation)	15
Figure 39. Electrical Schematic	16
Figure 40. Evaluation Kit – Top View	17
Figure 41. Evaluation Kit – Bottom View	17
Figure 42. Electrical Schematic for Evaluation Board	18
Figure 43. Control Pin Interface for Signal Integrity	20

Tables

Table 1.	Typical Values	1
Table 2.	Pin Descriptions.....	5
Table 3.	Absolute Maximum Ratings.....	6
Table 4.	Recommended Operating Conditions.....	6
Table 5.	Electrical Characteristics – 5V Supply Voltage.....	7
Table 6.	Electrical Characteristics – 3.3V Supply Voltage.....	8
Table 7.	Package Thermal Characteristics.....	9
Table 8.	Bill of Material (BOM)	19
Table 9.	RSET Biasing Resistor for Various Bias Currents (5V, 3.3V Supply).....	19

Pin Assignments

Figure 2. Pin Assignments for 2 × 2 × 0.75 mm 8-DFN Package – Top View

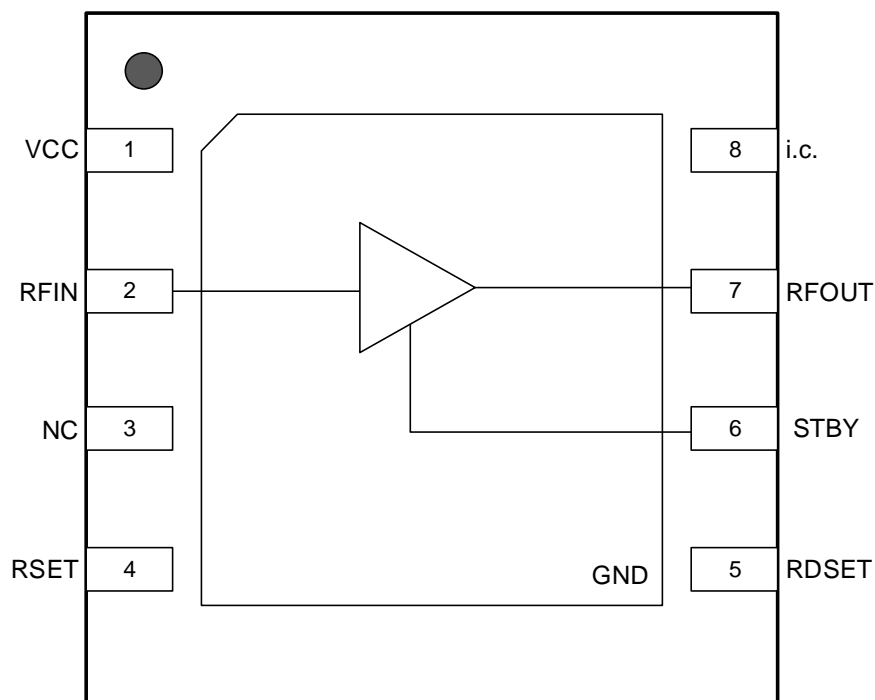

Pin Descriptions

Table 2. Pin Descriptions

Number	Name	Description
1	VCC	Power supply. The bypass capacitor must be as close to the pin as possible.
2	RFIN	RF input internally matched to 50Ω. An external DC block is required.
3	NC	No connection. This pin can be left unconnected, connected to VCC, or connected to GND. IDT recommends connecting it to GND.
4	RSET	Main amplifier current bias setting resistor. Connect to GND.
5	RDSET	Distortion amplifier current bias setting resistor. Connect to GND.
6	STBY	Standby. If this pin is not connected or is logic LOW, the device will operate under its normal operating condition. If this pin is logic HIGH, the F0424 will be in STBY Mode.
7	RFOUT	RF output internally matched to 50Ω. An external DC block is required.
8	i.c.	Connect this pin directly to ground.
	EPAD	Exposed pad. This pad is internally connected to GND. Solder this exposed pad to a printed circuit board (PCB) pad that uses multiple ground vias to provide heat transfer out of the device into the PCB ground planes. These multiple ground vias are also required to achieve the specified RF performance.

Absolute Maximum Ratings

The absolute maximum ratings are stress ratings only. Stresses greater than those listed below can cause permanent damage to the device. Functional operation of the F0424 at absolute maximum ratings is not implied. Exposure to absolute maximum rating conditions may affect device reliability.

Table 3. Absolute Maximum Ratings

Parameter	Symbol	Minimum	Maximum	Units
V _{CC} to GND	V _{CC}	-0.3	+5.5	V
STBY	V _{STBY}	-0.3	+3.6	V
STBY Minus VCC Voltage (voltage difference)	V _{STBY-VCC}		0.3	V
RFIN Externally Applied DC Current	I _{RFIN}	-1	+1	mA
RFOUT Externally Applied DC Voltage	V _{RFOUT}	V _{CC} - 0.15	V _{CC} + 0.15	V
RSET Pin Maximum DC Current	I _{PIN4}	-1	+1	mA
RDSET Pin Maximum DC Current	I _{PIN5}	-1	+1	mA
RF Input Power (RFOUT) Present for 24 Hours Maximum [a]	P _{MAX_IN}		+20	dBm
Continuous Power Dissipation	P _{DISS}		0.6	W
Junction Temperature	T _{JMAX}		140	°C
Storage Temperature Range	T _{STOR}	-65	150	°C
Lead Temperature (soldering, 10s)			260	°C
Electrostatic Discharge – HBM (JEDEC/ESDA JS-001-2012)			2000 (Class 2)	V
Electrostatic Discharge – CDM (JEDEC 22-C101F)			1000 (Class C3)	V

[a] Exposure to these maximum RF levels can result in significant V_{CC} current draw due to overdriving the amplifier stages.

Recommended Operating Conditions

Table 4. Recommended Operating Conditions

Parameter	Symbol	Conditions	Minimum	Typical	Maximum	Units
Power Supply Voltage	V _{CC}	V _{CC} pins	3.15		5.25	V
Operating Temperature Range	T _{EPAD}	Exposed paddle temperature	-40		+105	°C
RF Frequency Range	f _{RF}	Operating range	600		4200	MHz
RFIN Source Impedance	Z _{RFIN}	Single-ended		50		Ω
RFOUT Load Impedance	Z _{RFOUT}	Single-ended		50		Ω

Electrical Characteristics

See the F0424 Typical Application Circuit in Figure 42. Specifications apply when operated with $V_{CC} = +5.0V$, $R_5 = 2.49k\Omega$, $R_6 = 160\Omega$, $T_{EPAD} = +25^\circ C$, $f_{RF} = 2.6GHz$, $STBY = LOW$, $Z_S = Z_L = 50\Omega$ single-ended, and output power = 0dBm/tone, unless stated otherwise. EVKit trace and connector losses are de-embedded (see the F0424EVBK Evaluation Kit in Figure 40).

Table 5. Electrical Characteristics – 5V Supply Voltage

Parameter	Symbol	Condition	Minimum	Typical	Maximum	Units
Logic Input High Threshold	V_{IH}		1.07 [a]			V
Logic Input Low Threshold	V_{IL}				0.8	V
Logic Current	I_{IH}, I_{IL}	Applied STBY voltage = 3.6V	-10		+100	μA
Supply Current	I_{CC}			70	80	mA
Pull-down Resistor on STBY pin	R_{STBY}			50		$k\Omega$
Standby Current	I_{CC_STBY}			2	3	mA
Settling Time	t_{SETTLE}	50% STBY control to within $\pm 0.5dB$ of final power level		0.25		μs
RF Input Return Loss	RL_{IN}			13		dB
RF Output Return Loss	RL_{OUT}			12		dB
Gain	G	$f_{RF} = 600MHz$		17.2		dB
		$f_{RF} = 1900MHz$		17.6		
		$f_{RF} = 2600MHz$	16	17.3		
		$f_{RF} = 3500MHz$		16.7		
		$f_{RF} = 4200MHz$		16.1		
Gain Flatness (amplitude)	G_{VAR}	$f_{RF} = 700MHz, \pm 100MHz$		± 0.15		dB
		$f_{RF} = 1900MHz, \pm 100MHz$		± 0.1		
		$f_{RF} = 2600MHz, \pm 100MHz$		± 0.1		
		$f_{RF} = 3500MHz, \pm 100MHz$		± 0.1		
		$f_{RF} = 4100MHz, \pm 100MHz$		± 0.15		
Gain Variation over Temperature	G_{TEMP}	$T_{EPAD} = -40^\circ C$ to $+105^\circ C$		± 0.2		dB
Noise Figure	NF	$f_{RF} = 2600MHz$		2.3	2.7	dB
		$f_{RF} = 3500MHz$		2.7		dB
Noise Figure Variation over Temperature	NF_{TEMP}	$T_{EPAD} = -40^\circ C$ to $+105^\circ C$		± 0.4		dB
Output Third-Order Intercept Point	OIP3	$f_{RF} = 2600MHz$ 5MHz tone separation	35	40		dBm
		$f_{RF} = 3500MHz$ 5MHz tone separation		40		
Output Third-Order Intercept Point Variation over Temperature	$OIP3_{VAR}$	$f_{RF} = 2600MHz$ 5MHz tone separation $T_{EPAD} = -40^\circ C$ to $+105^\circ C$		-1.2/+0.26		dB
Output P1dB compression	OP_{1dB}	$f_{RF} = 2600MHz$	20	21		dBm
		$f_{RF} = 3500MHz$		20		
Reverse Isolation	REV_{ISO}			24		dB

[a] Specifications in the minimum/maximum columns that are shown in **bold italics** are guaranteed by test. Specifications in these columns that are not shown in bold italics are guaranteed by design characterization.

Electrical Characteristics

See the F0424 Typical Application Circuit. Specifications apply when operated with $V_{CC} = +3.3V$, $R_5 = 2.49k\Omega$, $R_6 = 160\Omega$, $T_{EPAD} = +25^\circ C$, $f_{RF} = 2.6GHz$, $STBY = LOW$, $Z_S = Z_L = 50\Omega$ single-ended, and output power = 0dBm/tone, unless stated otherwise. EVKit trace and connector losses are de-embedded.

Table 6. Electrical Characteristics – 3.3V Supply Voltage

Parameter	Symbol	Condition	Minimum	Typical	Maximum	Units
Logic Input High Threshold	V_{IH}		<i>1.07</i> [a]			V
Logic Input Low Threshold	V_{IL}				<i>0.8</i>	V
Logic Current	I_{IH}, I_{IL}	Applied STBY voltage = 3.6V	<i>-10</i>		<i>+100</i>	μA
Supply Current	I_{CC}			70		mA
Pull-Down Resistor on STBY Pin	R_{STBY}			50		$k\Omega$
Standby Current	I_{CC_STBY}			2		mA
Settling Time	t_{SETTLE}	50% STBY control to within $\pm 0.5dB$ of final power level		0.25		μs
RF Input Return Loss	RL_{IN}			13		dB
RF Output Return Loss	RL_{OUT}			12		dB
Gain	G	$f_{RF} = 600MHz$		17.2		dB
		$f_{RF} = 1900MHz$		17.6		
		$f_{RF} = 2600MHz$		17.3		
		$f_{RF} = 3500MHz$		16.7		
		$f_{RF} = 4200MHz$		16.1		
Gain Flatness (amplitude)	G_{VAR}	$f_{RF} = 700MHz, \pm 100MHz$		± 0.15		dB
		$f_{RF} = 1900MHz, \pm 100MHz$		± 0.1		
		$f_{RF} = 2600MHz, \pm 100MHz$		± 0.1		
		$f_{RF} = 3500MHz, \pm 100MHz$		± 0.2		
		$f_{RF} = 4100MHz, \pm 100MHz$		± 0.15		
Gain Variation over Temperature	G_{TEMP}	$T_{EPAD} = -40^\circ C$ to $+105^\circ C$		± 0.2		dB
Noise Figure	NF	$f_{RF} = 2600MHz$		2.3		dB
		$f_{RF} = 3500MHz$		2.7		dB
Noise Figure Variation over Temperature	NF_{TEMP}	$T_{EPAD} = -40^\circ C$ to $+105^\circ C$		+0.5/-0.4		dB
Output Third Order Intercept Point	OIP3	$f_{RF} = 2600MHz$ 5MHz tone separation		33		dBm
		$f_{RF} = 3500MHz$ 5MHz tone separation		31		
Output P1dB compression	OP_{1dB}	$f_{RF} = 2600MHz$		16.4		dBm
		$f_{RF} = 3500MHz$		15.5		
Reverse Isolation	REV_{ISO}			24		dB

[a] Specifications in the minimum/maximum columns that are shown in bold italics are guaranteed by test. Specifications in these columns that are not shown in bold italics are guaranteed by design characterization.

Thermal Characteristics

Table 7. Package Thermal Characteristics

Parameter	Symbol	Value	Units
Junction-to-Ambient Thermal Resistance.	θ_{JA}	93	°C/W
Junction-to-Case Thermal Resistance. (Case is defined as the exposed paddle)	θ_{JC-BOT}	27	°C/W
Moisture Sensitivity Rating (Per J-STD-020)		MSL-1	

Typical Operating Conditions (TOC)

- Evaluation kit connector and trace losses de-embedded
- $V_{CC} = 5.0V$ (plots also taken with $V_{CC} = 3.3V$)
- $T_{EPAD} = +25^{\circ}C$
- STBY = not connected (internally pulled logic low)
- RSET (R5) = 2.49K unless otherwise noted
- Small signal parameters measured with $P_{OUT} = 0dBm$
- Two tone tests $P_{OUT} = 0dBm$ /tone with 5MHz tone spacing
- $Z_L = Z_S = 50\Omega$, single-ended

Typical Performance Characteristics

Figure 3. Gain versus Temperature (5V Variation)

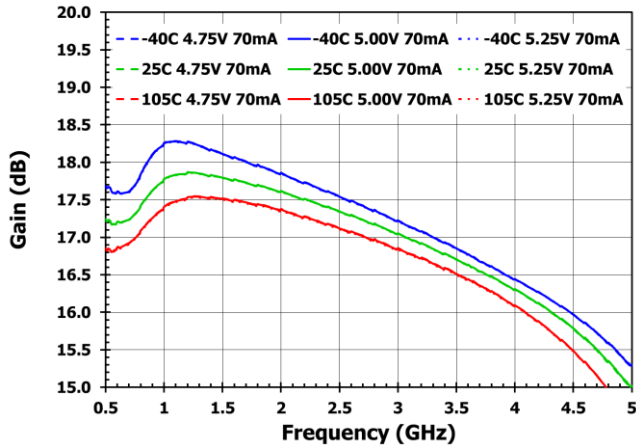

Figure 4. Gain versus Temperature (3.3V Variation)

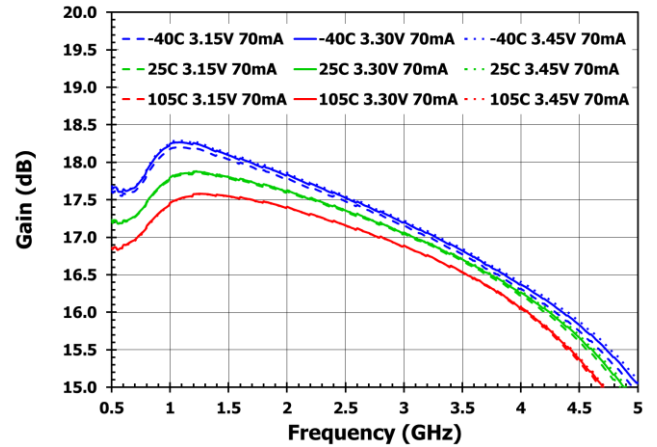

Figure 5. Gain versus Bias Current (5.0V)

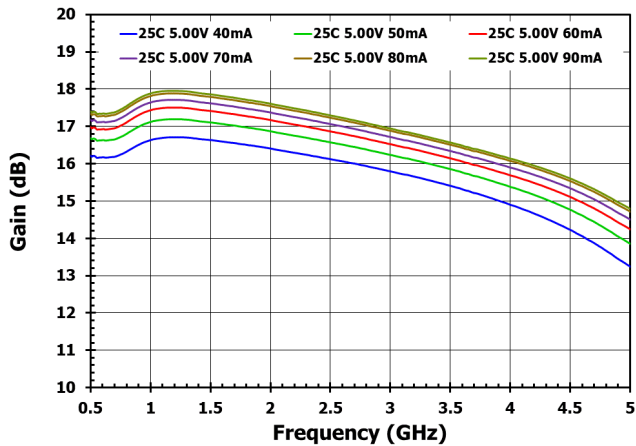

Figure 6. Gain versus Bias Current (3.3V)

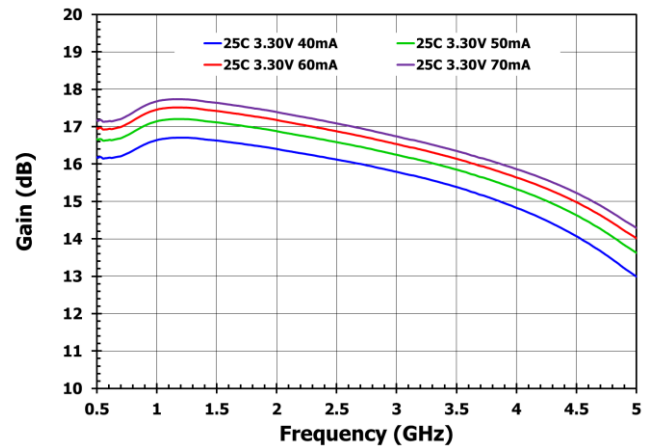

Figure 7. Output IP3 versus Temperature (5V Variation, 70mA)

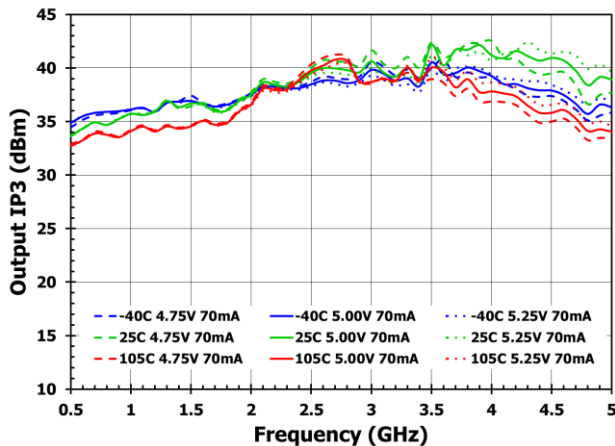
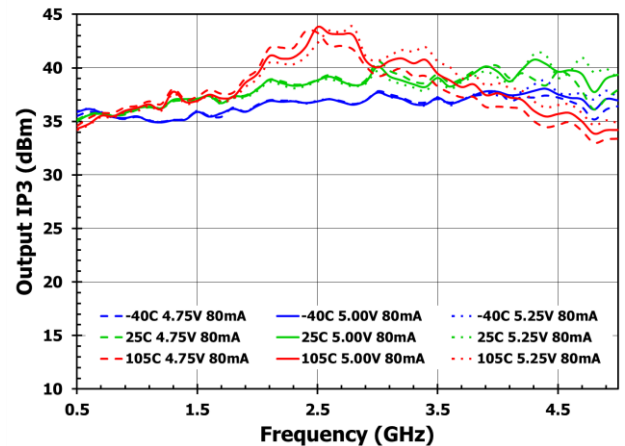

Figure 8. Output IP3 versus Temperature (5V Variation, 80mA)



Typical Performance Characteristics

Figure 9. Output IP3 versus Temperature (3.3V Variation, 70mA)

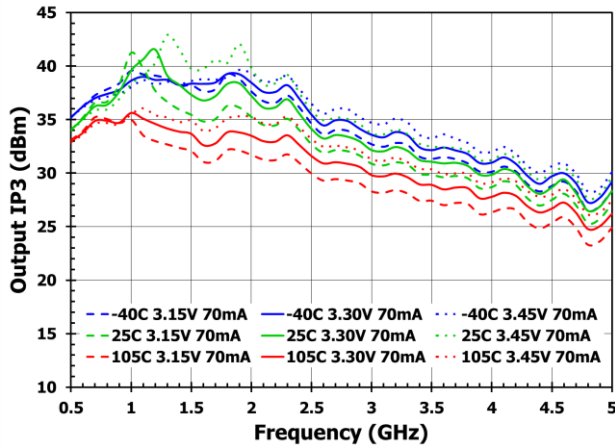

Figure 10. Output IP3 versus Temperature (3.3V Variation, 40mA)

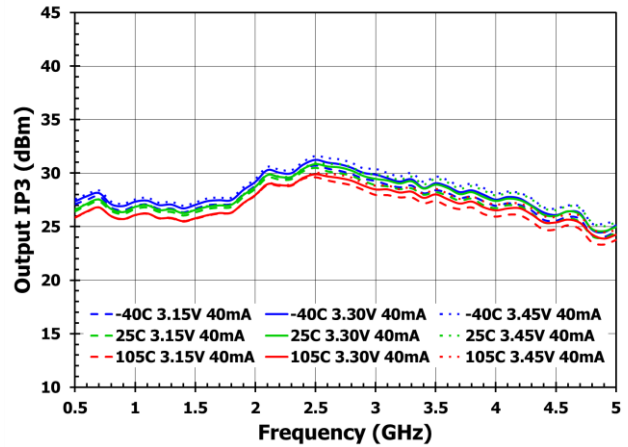

Figure 11. Output IP3 versus Bias Current (5.0V)

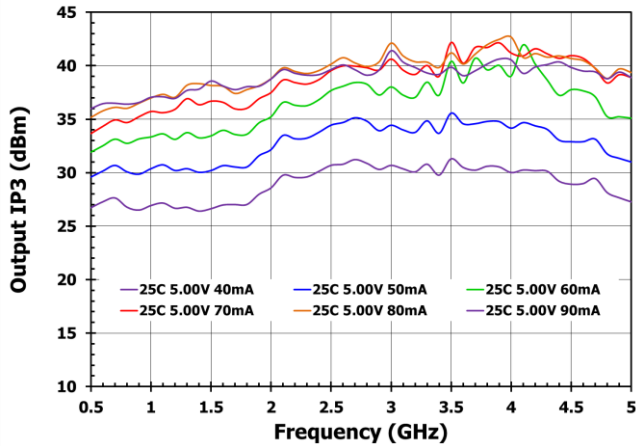

Figure 12. Output IP3 versus Bias Current (3.3V)

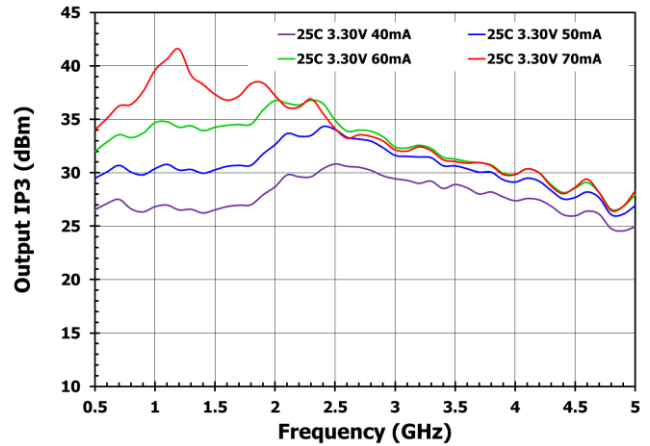

Figure 13. Output 1dB Compression versus Temperature (5V Variation, 70mA)

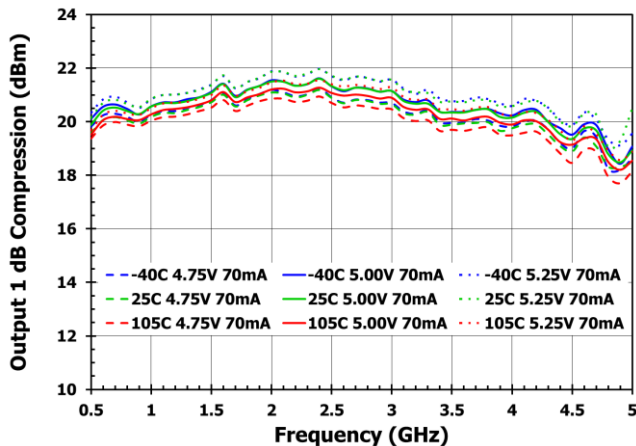
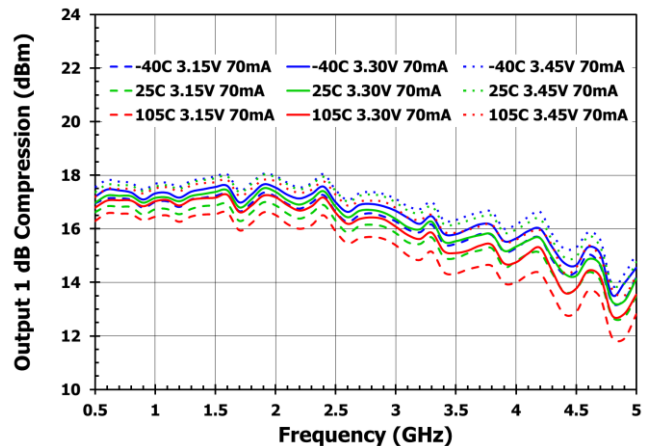

Figure 14. Output 1dB Compression versus Temperature (3.3V Variation, 70mA)



Typical Performance Characteristics

Figure 15. Gain Compression versus Temperature (5V, 0.7GHz, 70mA)

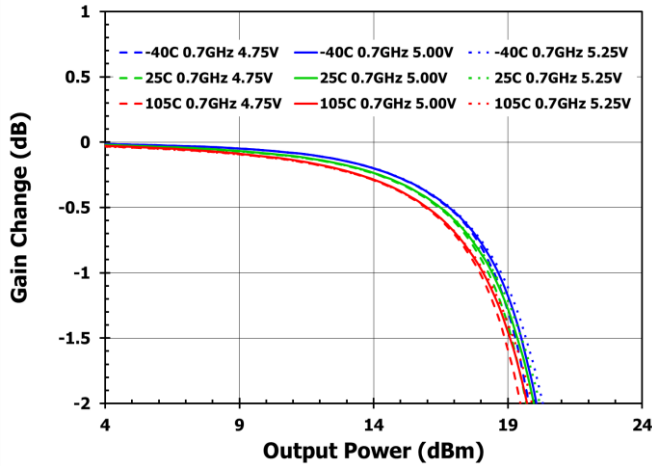

Figure 16. Phase Compression versus Temperature (5V, 0.7GHz, 70mA)

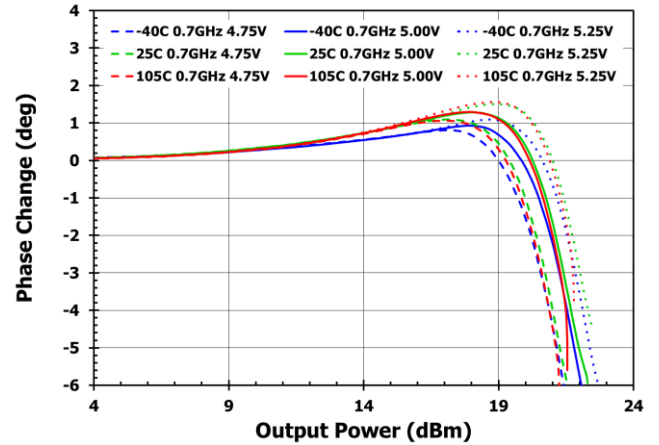

Figure 17. Gain Compression versus Temperature (5V, 1.9GHz, 70mA)

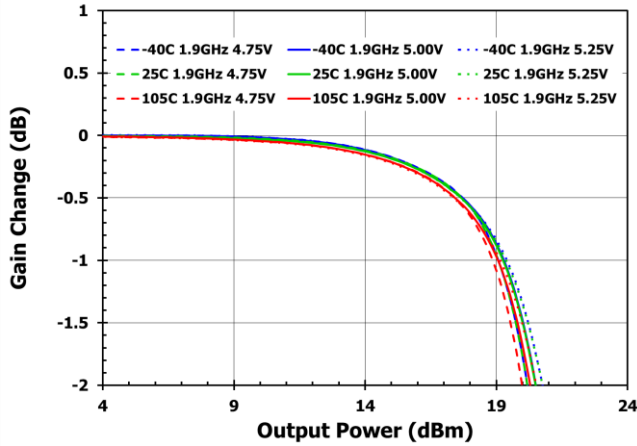

Figure 18. Phase Compression versus Temperature (5V, 1.9GHz, 70mA)

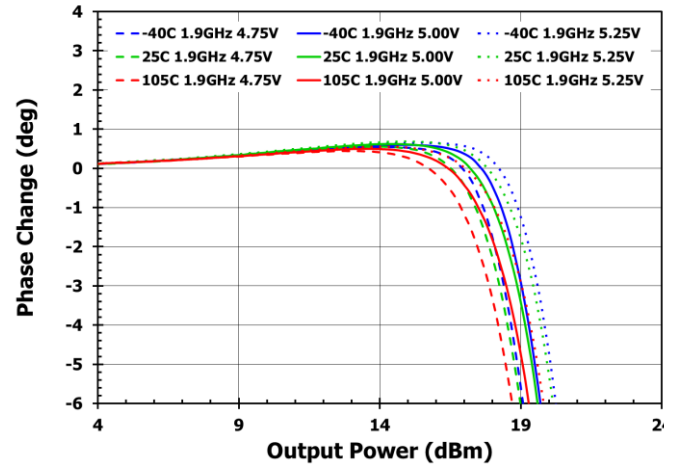

Figure 19. Gain Compression versus Temperature (5V, 2.6GHz, 70mA)

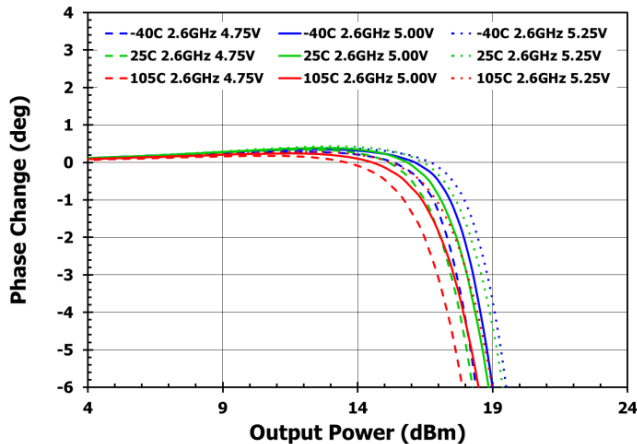
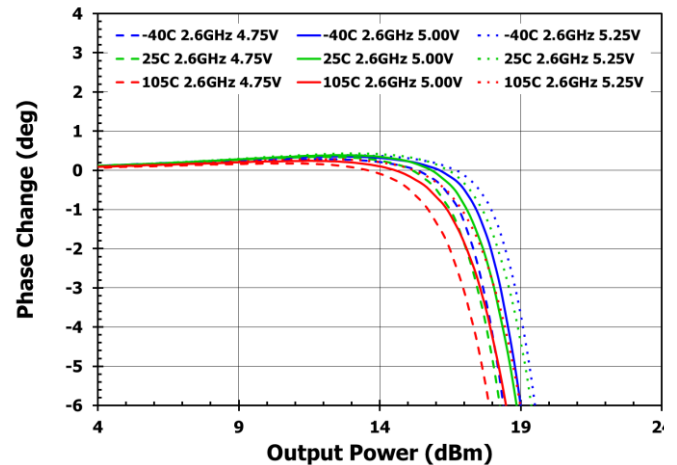

Figure 20. Phase Compression versus Temperature (5V, 2.6GHz, 70mA)



Typical Performance Characteristics

Figure 21. Gain Compression versus Temperature (5V, 3.5GHz, 70mA)

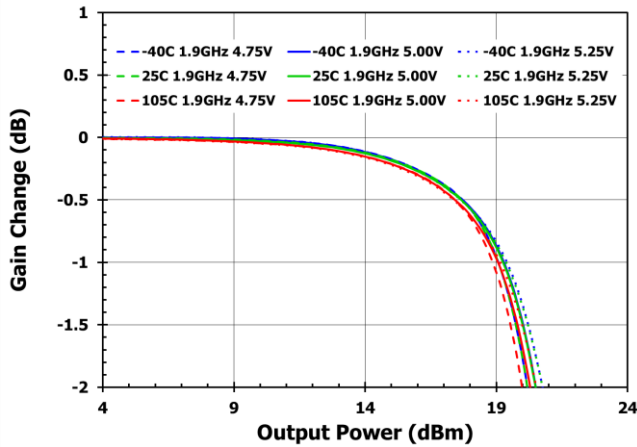

Figure 22. Phase Compression versus Temperature (5V, 3.5GHz, 70mA)

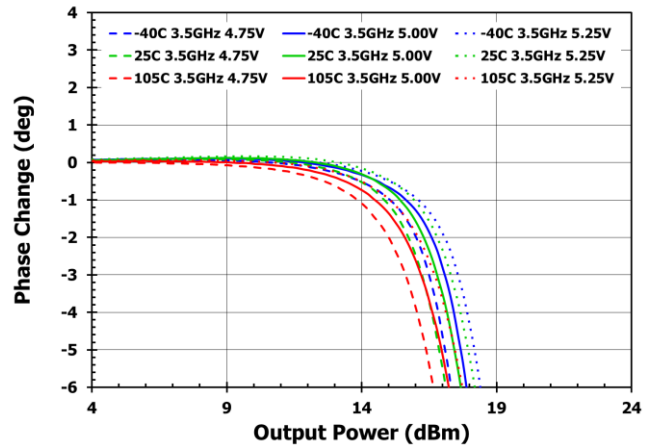

Figure 23. Gain Compression versus Temperature (5V, 4.1GHz, 70mA)

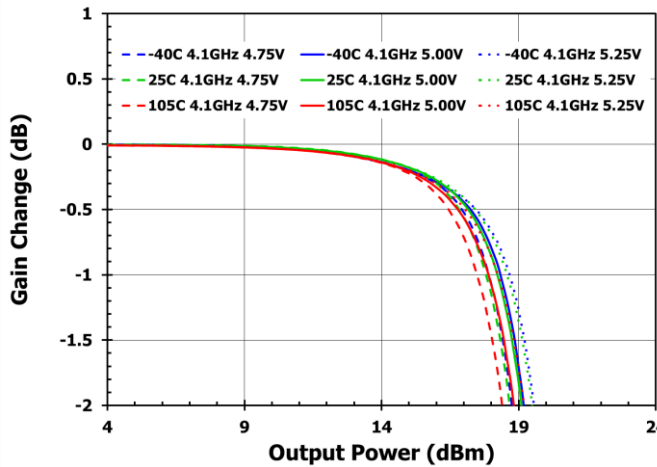

Figure 24. Phase Compression versus Temperature (5V, 4.1GHz, 70mA)

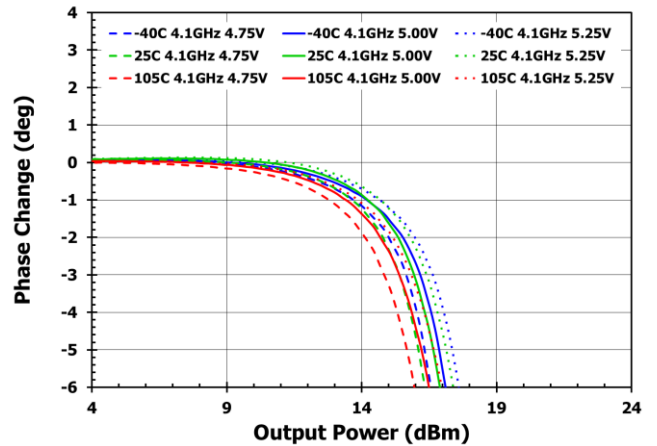

Figure 25. Gain Compression versus Temperature (3.3V, 2.6GHz, 70mA)

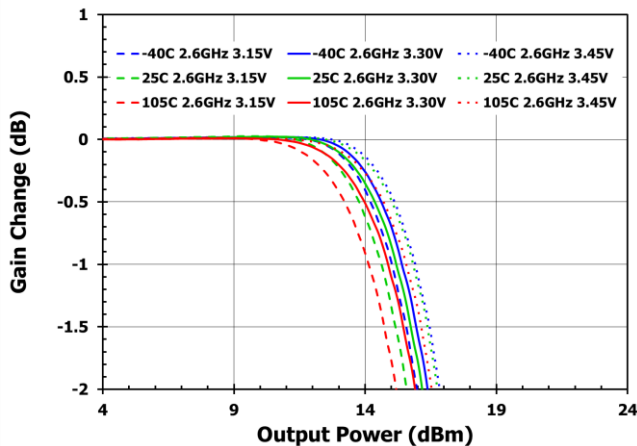
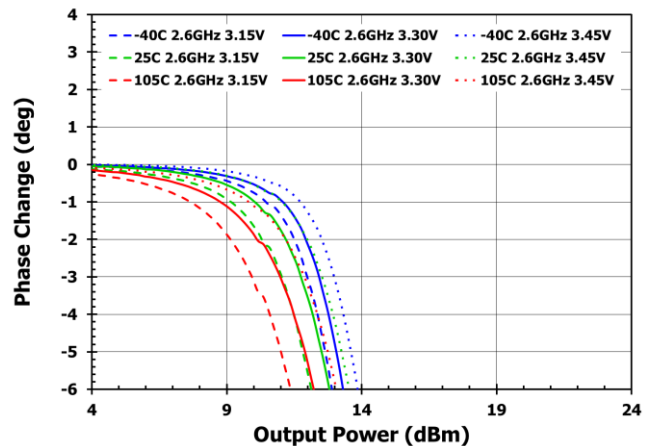

Figure 26. Phase Compression versus Temperature (3.3V, 2.6GHz, 70mA)



Typical Performance Characteristics

Figure 27. RFIN Return Loss versus Temperature (5V Variation)

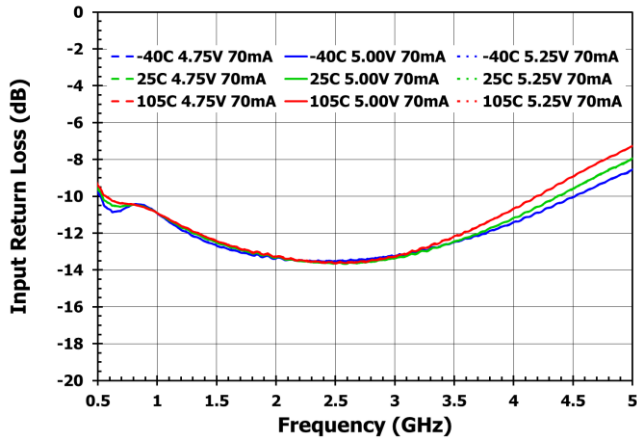

Figure 28. RFIN Return Loss versus Temperature (3.3V Variation)

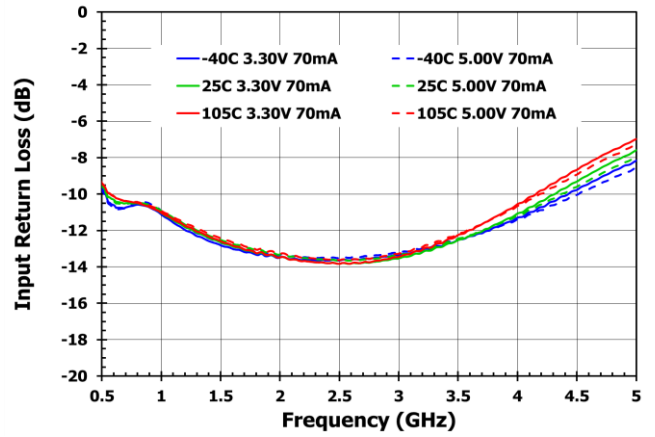

Figure 29. RFOUT Return Loss versus Temperature (5V Variation)

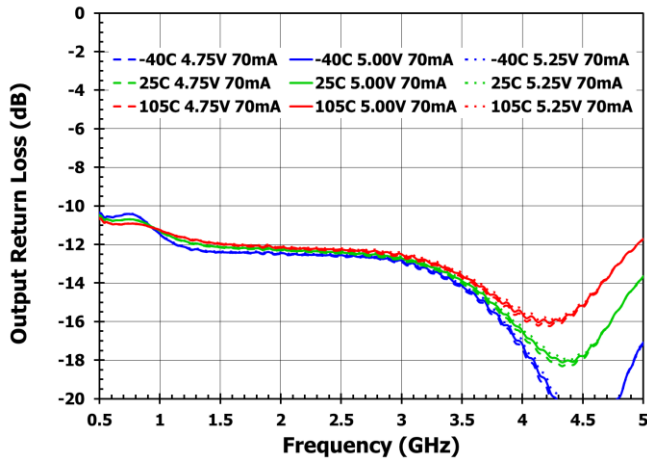

Figure 30. RFOUT Return Loss versus Temperature (3.3V Variation)

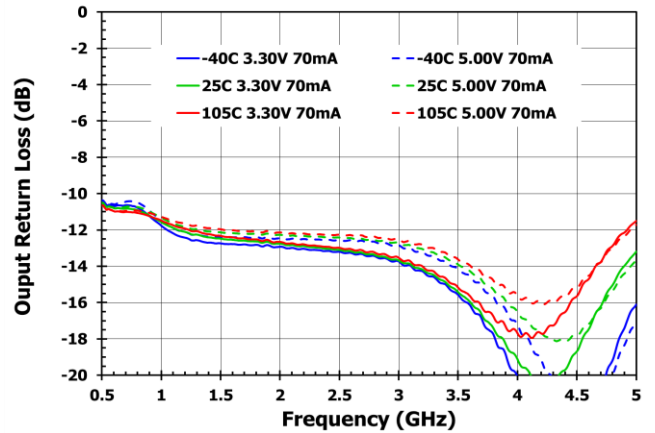

Figure 31. Reverse Gain versus Temperature (5V Variation)

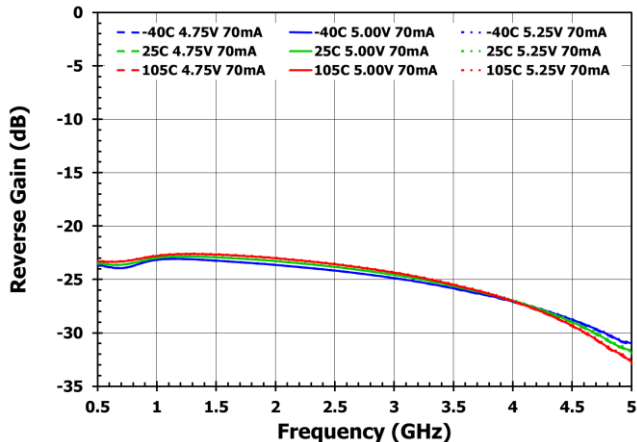
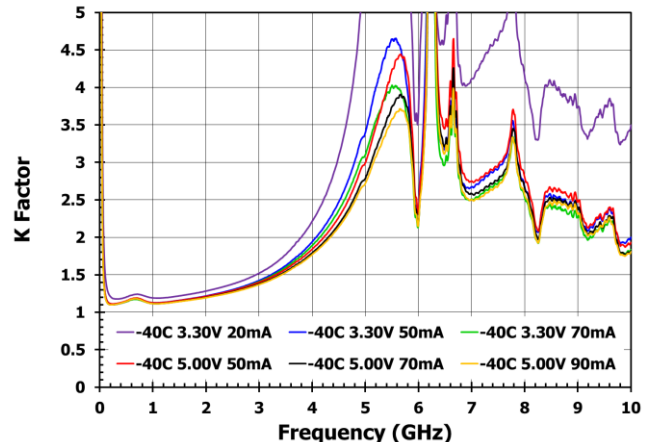

Figure 32. Stability Factor for Various Currents (3.3V, 5.0V, -40°C, R8=1K)



Typical Performance Characteristics

Figure 33. Turn-on Time (3.3V)

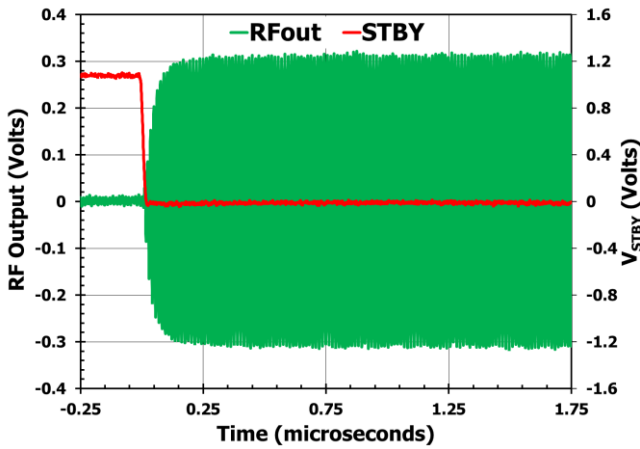

Figure 34. Turn-on Time (5.0V)

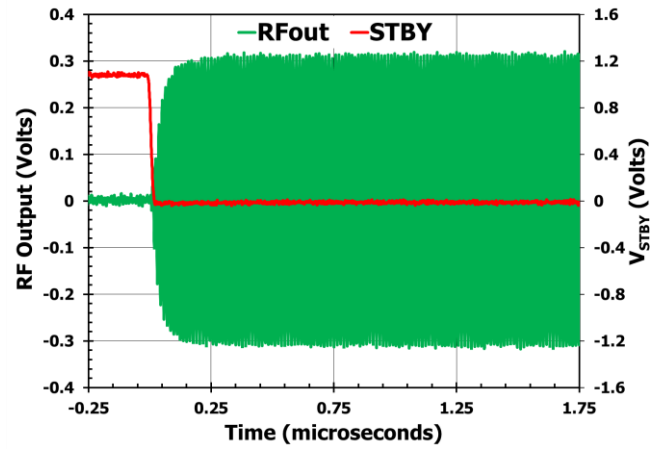

Figure 35. Noise Figure versus Temperature (5.0V Variation)

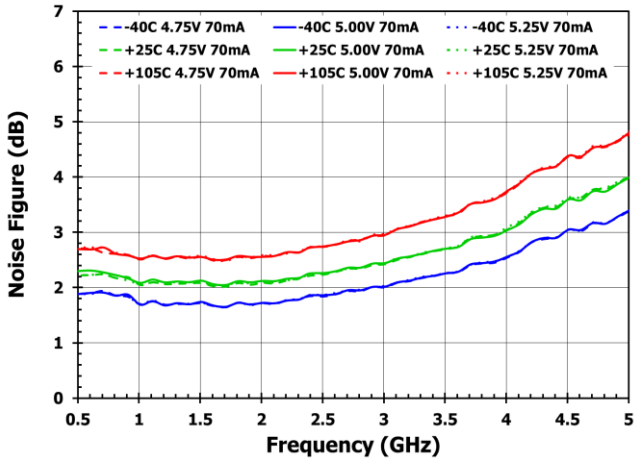

Figure 36. Noise Figure versus Temperature (3.3V Variation)

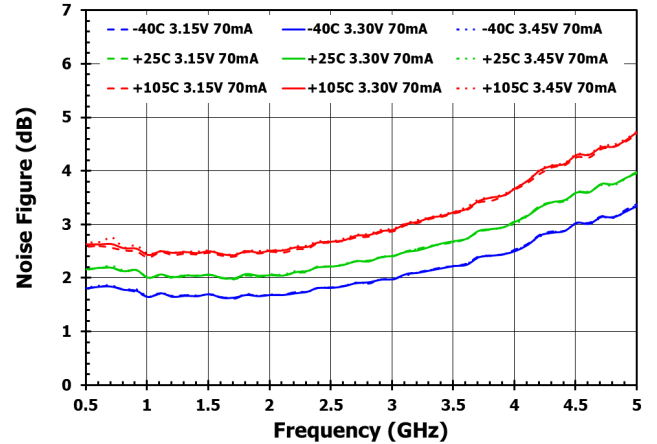

Figure 37. Noise Figure versus Current (5.0V Variation)

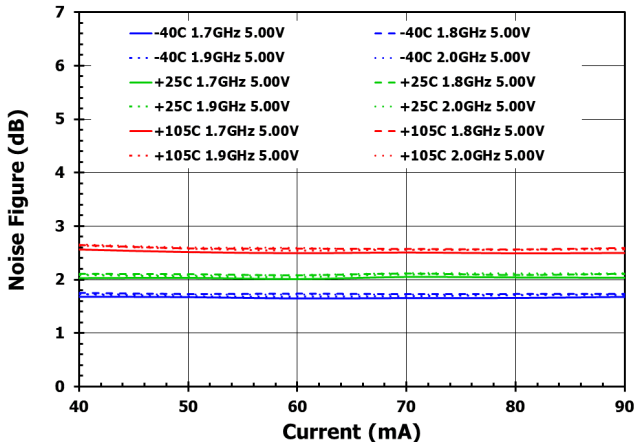
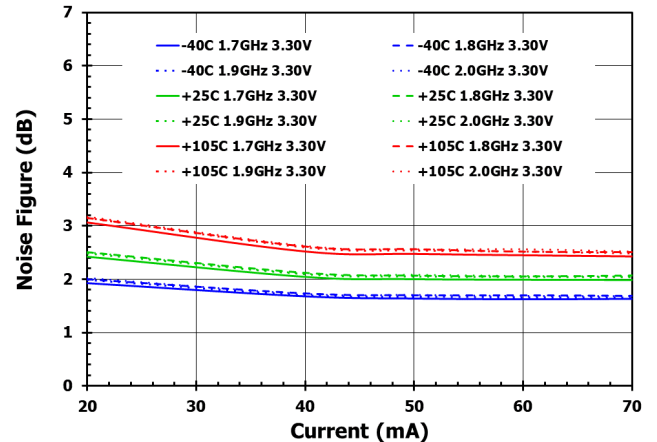

Figure 38. Noise Figure versus Current (3.3V Variation)



Typical Application Circuit

Figure 39 is a typical circuit (minimum components) that can be use in a design for the F0424 by the customer.

Figure 39. Electrical Schematic

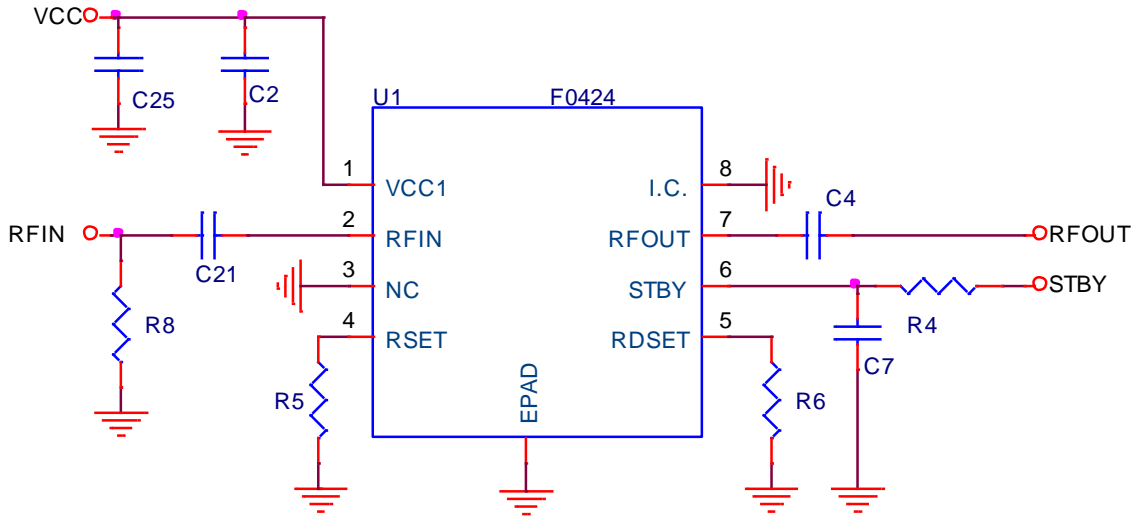

Evaluation Kit Picture

Figure 40. Evaluation Kit – Top View

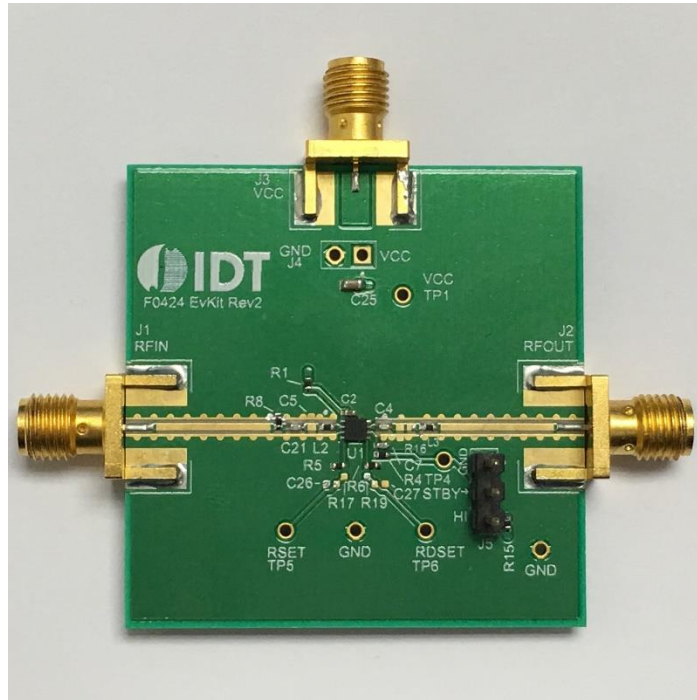
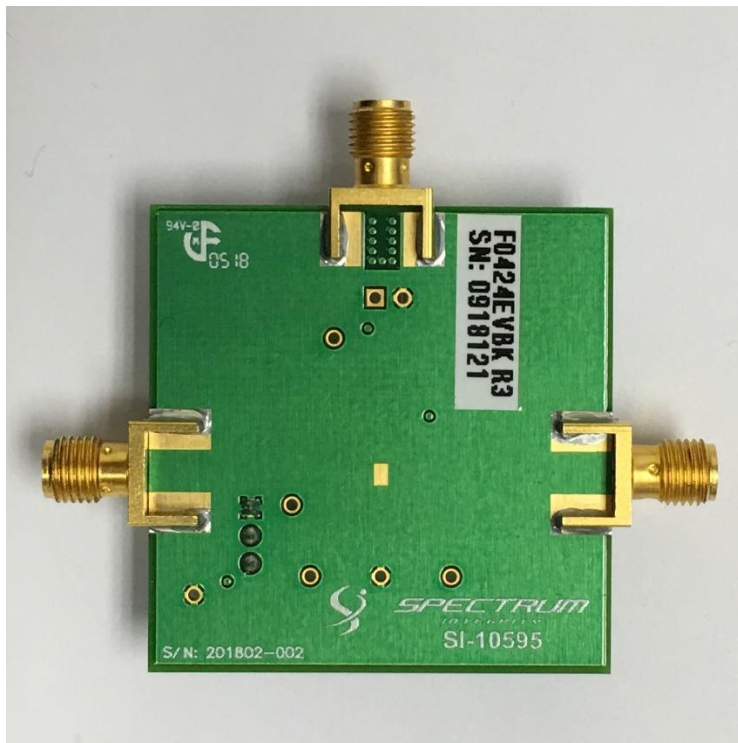

Figure 41. Evaluation Kit – Bottom View



Evaluation Kit / Applications Circuit

Figure 42. Electrical Schematic for Evaluation Board

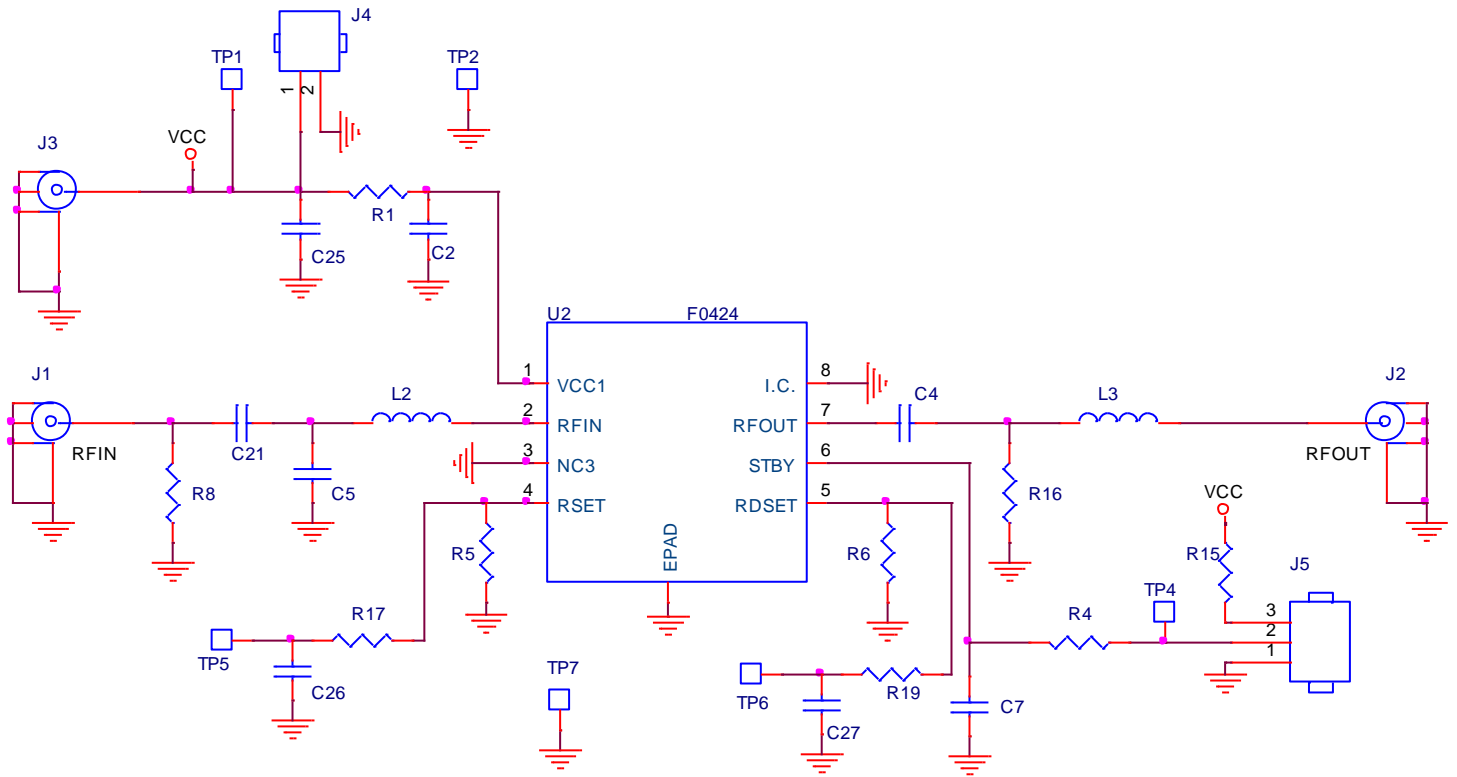

Table 8. Bill of Material (BOM)

Part Reference	QTY	Description	Manufacturer Part #	Manufacturer
C2	1	10nF $\pm 5\%$ 50V X7R Ceramic Capacitor (0402)	GRM155R71H103J	Murata
C4, C21	2	22pF $\pm 5\%$, 50V, C0G Ceramic Capacitor (0402)	GRM1555C1H220J	Murata
C7	1	2pF $\pm 0.1\text{pF}$ 100V C0G, Ceramic Capacitor (0402)	GRM1555C1H2R0B	Murata
C25	1	1 μF $\pm 10\%$ 16V X7R Ceramic Capacitor (0603)	GRM188R71C105K	Murata
L2, L3, R1, R15	4	0 Ω 1/10W Resistors (0402)	ERJ-2GE0R00X	Panasonic
R4, R8	1	1k Ω $\pm 1\%$ 1/10W Resistor (0402)	ERJ-3EKF1001X	Panasonic
R5	1	2.49k Ω $\pm 1\%$ 1/10W Resistor (0402) see Table 9 for resistor value versus operating current	ERJ-2RKF2491X	Panasonic
R6	1	160 Ω $\pm 1\%$ 1/10W Resistor (0402)	ERJ-2RKF1600X	Panasonic
J1, J2, J3	3	Edge Launch SMA (0.375 inch pitch ground tab)	142-0701-851	Emerson Johnson
J4	0	CONN HEADER VERT SGL 2 X 1 POS GOLD	961102-6404-AR	3M
J5	1	CONN HEADER VERT SGL 3 X 1 POS GOLD	961103-6404-AR	3M
TP1	1	TEST POINT PC MINI .040"D RED	Keystone5000	Keystone
TP2	1	TEST POINT PC MINI .040"D BLACK	Keystone5001	Keystone
TP4, TP5, TP6, TP7	0	DNP		
U1	1	High Gain Broadband RF Amplifier	F0424	IDT
C5, C26, C27, R16, R17, R19	NA	These components are not populated		

Table 9. RSET Biasing Resistor for Various Bias Currents (5V, 3.3V Supply)

Operating I_{cc}	RSET Resistor (R5)
40mA	6.19k Ω
50mA	4.22k Ω
60mA	3.16k Ω
70mA	2.49k Ω
80mA	2.00k Ω
90mA	1.74k Ω

NOTE: 1% Resistors can be substituted with 5% equivalents.

Applications Information

Power Supplies

A common V_{CC} power supply should be used for all pins requiring DC power. All supply pins should be bypassed with external capacitors to minimize noise and fast transients. Supply noise can degrade the noise figure, and fast transients can trigger ESD clamps and cause them to fail. Supply voltage change or transients should have a slew rate smaller than $1V/20\mu S$. In addition, all control pins should remain at 0V ($\pm 0.3V$) while the supply voltage ramps or while it returns to zero.

If control signal integrity is a concern and clean signals cannot be guaranteed due to overshoot, undershoot, ringing, etc., the following circuit at the input of the STBY control pin is recommended. This applies to the STBY pin as shown below. Note the recommended resistor and capacitor values do not necessarily match the EVKit BOM for the case of poor control signal integrity. For multiple devices driven by a single control line, the component values will need to be adjusted accordingly so as not to load down the control line.

Figure 43. Control Pin Interface for Signal Integrity

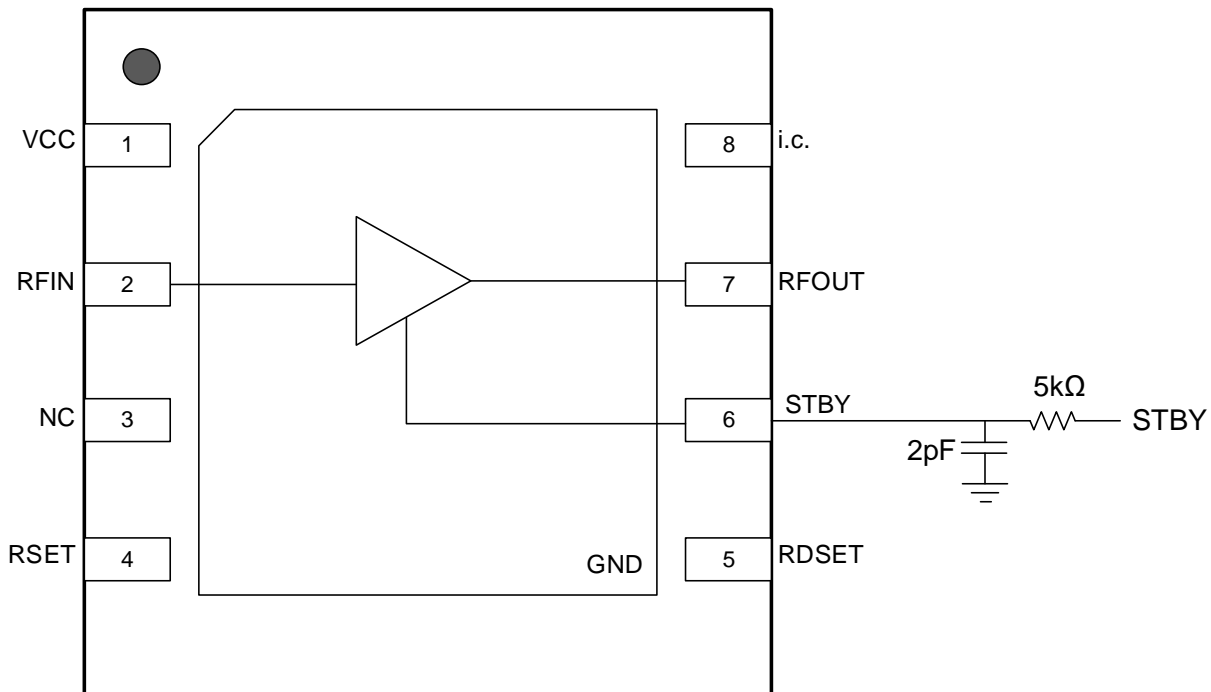

Package Outline Drawings

The package outline drawings are appended at the end of this document and are accessible from the link below. The package information is the most current data available.

<https://www.idt.com/document/psc/8-dfn-package-outline-drawing-20-x-20-x-075-mm-body-05mm-pitch-epad-08-x-160-mm-ntg8p2>

Marking Diagram

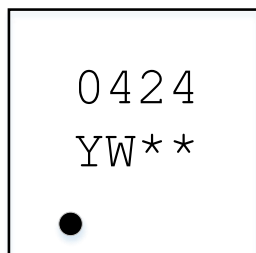

Line 1 – 0424 = abbreviated the part number.

Line 2 – Y = Year code, last digit of production year (“8” would correspond to 2018).

Line 2 – W = Work week code (“W” corresponds to week 30).

Line 2 - ** = Sequential alphanumeric for lot traceability.

Information

Orderable Part Number	Description and Package	MSL Rating	Carrier Type	Temperature
F0424NTGK	F0424 High-Gain Broadband RF Amplifier, 2.0 × 2.0 × 0.75 mm 8-DFN (NTG8P2)	1	Tray	-40°C to +105°C
F0424NTGK8	F0424 High-Gain Broadband RF Amplifier, 2.0 × 2.0 × 0.75 mm 8-DFN (NTG8P2)	1	Reel	-40°C to +105°C
F0424EVBK	Evaluation Board			

Revision History

Revision Date	Description of Change
March 7, 2019	<ul style="list-style-type: none"> ▪ Added simplified application circuit. ▪ Updated datasheet format
May 5, 2018	Initial release.



Corporate Headquarters

6024 Silver Creek Valley Road
 San Jose, CA 95138
www.IDT.com

Sales

1-800-345-7015 or 408-284-8200
 Fax: 408-284-2775
www.IDT.com/go/sales

Tech Support

www.IDT.com/go/support

DISCLAIMER Integrated Device Technology, Inc. (IDT) and its affiliated companies (herein referred to as "IDT") reserve the right to modify the products and/or specifications described herein at any time, without notice, at IDT's sole discretion. Performance specifications and operating parameters of the described products are determined in an independent state and are not guaranteed to perform the same way when installed in customer products. The information contained herein is provided without representation or warranty of any kind, whether express or implied, including, but not limited to, the suitability of IDT's products for any particular purpose, an implied warranty of merchantability, or non-infringement of the intellectual property rights of others. This document is presented only as a guide and does not convey any license under intellectual property rights of IDT or any third parties.

IDT's products are not intended for use in applications involving extreme environmental conditions or in life support systems or similar devices where the failure or malfunction of an IDT product can be reasonably expected to significantly affect the health or safety of users. Anyone using an IDT product in such a manner does so at their own risk, absent an express, written agreement by IDT.

Integrated Device Technology, IDT and the IDT logo are trademarks or registered trademarks of IDT and its subsidiaries in the United States and other countries. Other trademarks used herein are the property of IDT or their respective third party owners. For datasheet type definitions and a glossary of common terms, visit www.idt.com/go/glossary. All contents of this document are copyright of Integrated Device Technology, Inc. All rights reserved.

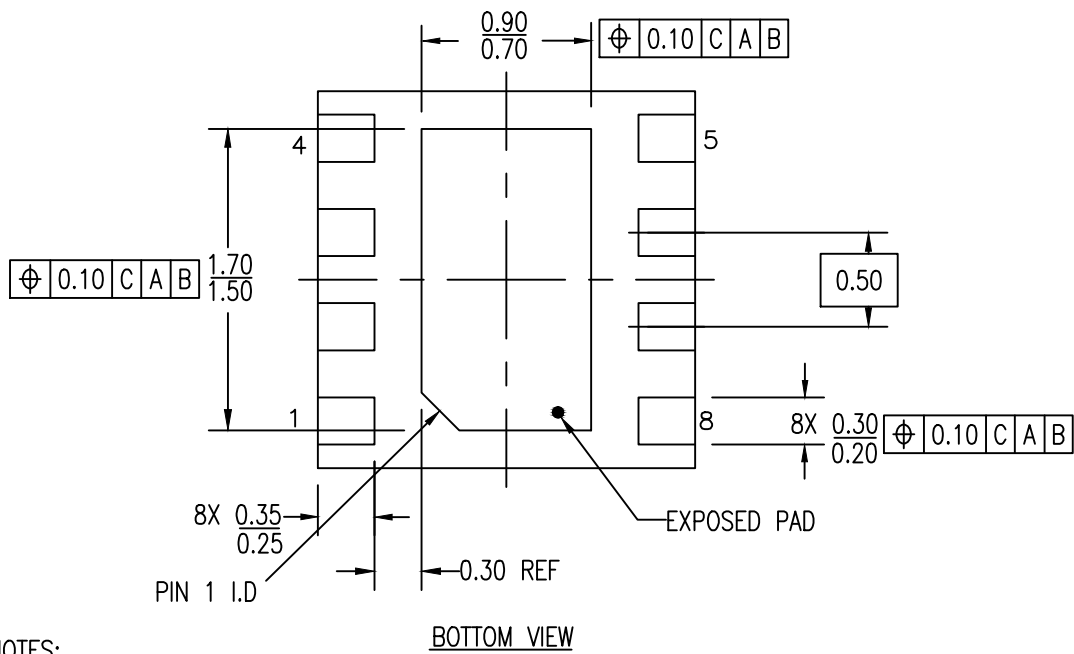
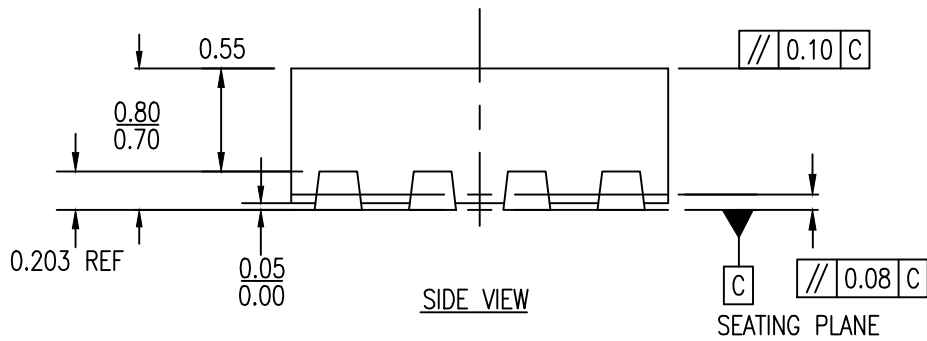
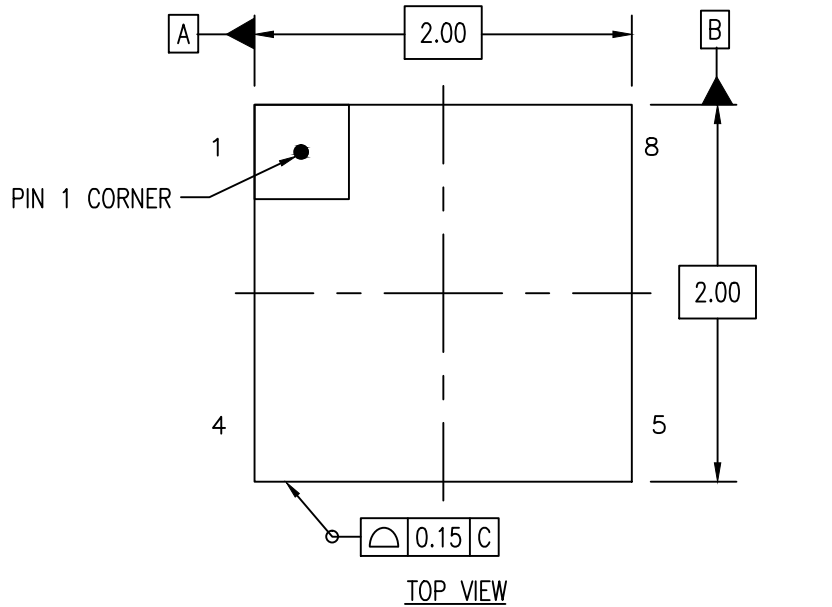

NOTES:

1. ALL DIMENSIONS ARE IN MILLIMETERS.
2. ALL DIMENSIONING AND TOLERANCING CONFORM TO ASME Y14.5M-1994

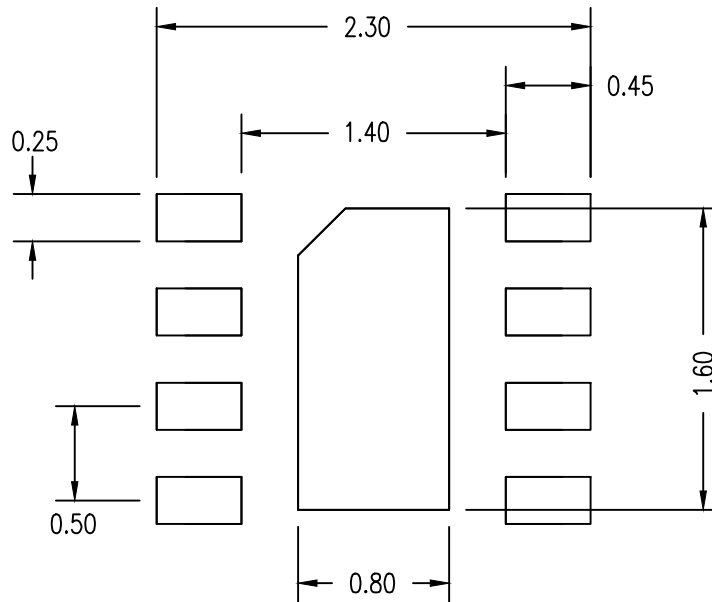

RECOMMENDED LAND PATTERN DIMENSION

NOTES:

1. ALL DIMENSIONS ARE IN MM. ANGLES IN DEGREES.
2. TOP DOWN VIEW, AS VIEWED ON PCB.
3. LAND PATTERN RECOMMENDATION PER IPC-7351B GENERIC REQUIREMENT FOR SURFACE MOUNT DESIGN AND LAND PATTERN.

Package Revision History		
Date Created	Rev No.	Description
Feb 12, 2018	Rev 01.	New Format, Change QFN to VFQFPN
April 12, 2018	Rev 02	Change "VFQFPN" to "DFN"



Компания «ЭлектроПласт» предлагает заключение долгосрочных отношений при поставках импортных электронных компонентов на взаимовыгодных условиях!

Наши преимущества:

- Оперативные поставки широкого спектра электронных компонентов отечественного и импортного производства напрямую от производителей и с крупнейших мировых складов;
- Поставка более 17-ти миллионов наименований электронных компонентов;
- Поставка сложных, дефицитных, либо снятых с производства позиций;
- Оперативные сроки поставки под заказ (от 5 рабочих дней);
- Экспресс доставка в любую точку России;
- Техническая поддержка проекта, помощь в подборе аналогов, поставка прототипов;
- Система менеджмента качества сертифицирована по Международному стандарту ISO 9001;
- Лицензия ФСБ на осуществление работ с использованием сведений, составляющих государственную тайну;
- Поставка специализированных компонентов (Xilinx, Altera, Analog Devices, Intersil, Interpoint, Microsemi, Aeroflex, Peregrine, Syfer, Eurofarad, Texas Instrument, Miteq, Cobham, E2V, MA-COM, Hittite, Mini-Circuits, General Dynamics и др.);

Помимо этого, одним из направлений компании «ЭлектроПласт» является направление «Источники питания». Мы предлагаем Вам помощь Конструкторского отдела:

- Подбор оптимального решения, техническое обоснование при выборе компонента;
- Подбор аналогов;
- Консультации по применению компонента;
- Поставка образцов и прототипов;
- Техническая поддержка проекта;
- Защита от снятия компонента с производства.



Как с нами связаться

Телефон: 8 (812) 309 58 32 (многоканальный)

Факс: 8 (812) 320-02-42

Электронная почта: org@eplast1.ru

Адрес: 198099, г. Санкт-Петербург, ул. Калинина, дом 2, корпус 4, литера А.