



## Schottky Barrier Diode

Qualified per MIL-PRF-19500/444

Qualified Levels:  
JAN, JANTX, and  
JANTXV

### DESCRIPTION

This Schottky barrier diode is metallurgically bonded and offers military grade qualifications for high-reliability applications on "1N" prefixed numbers. This small diode is hermetically sealed and bonded into a DO-35 glass package.

**Important:** For the latest information, visit our website <http://www.microsemi.com>.

### FEATURES

- JEDEC registered 1N5711-1, 1N5712-1, 1N6857-1, and 1N6858-1 numbers.
- Metallurgically bonded.
- JAN, JANTX, JANTXV and commercial qualifications also available per MIL-PRF-19500/444 on "1N" numbers only.  
(See [Part Nomenclature](#) for all available options).
- RoHS compliant versions available (commercial grade only).

### APPLICATIONS / BENEFITS

- Low reverse leakage characteristics.
- Small size for high density mounting using flexible thru-hole leads (see package illustration).
- ESD sensitive to Class 1.

### MAXIMUM RATINGS @ 25 °C unless otherwise stated

Parameters/Test Conditions	Symbol	Value	Unit
Junction and Storage Temperature	T <sub>J</sub> and T <sub>STG</sub>	-65 to +150	°C
Thermal Resistance, Junction-to-Lead @ lead length = 0.375 inch (9.52 mm) from body	R <sub>θJL</sub>	250	°C/W
Average Rectified Output Current:	I <sub>O</sub>	33	mA
1N5711 <sup>(1)</sup>		75	
DSB2810, DSB5712, 1N5712 & 1N6858 <sup>(2)</sup> 1N6857 <sup>(3)</sup>		150	
Solder Temperature @ 10 s		260	°C

- NOTES:**
1. At T<sub>L</sub> = +130°C and L = 0.375 inch, derate I<sub>O</sub> to 0 at +150°C.
  2. At T<sub>L</sub> = +110°C and L = 0.375 inch, derate I<sub>O</sub> to 0 at +150°C.
  3. At T<sub>L</sub> = +70°C and L = 0.375 inch, derate I<sub>O</sub> to 0 at +150°C.

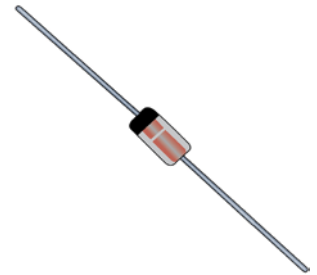

**DO-35 (DO-204AH)  
Package**

Also available in:

 **UB package**  
(3-pin surface mount)  
[1N5711UB](#), [1N5712UB](#)  
([B](#), [CC](#), [CA](#))

 **DO-213AA package**  
(surface mount)  
[1N5711UR-1](#), [1N5712UR-1](#),  
[1N6857UR-1](#), and  
[1N6858UR-1](#)

#### **MSC – Lawrence**

6 Lake Street,  
Lawrence, MA 01841  
Tel: 1-800-446-1158 or  
(978) 620-2600  
Fax: (978) 689-0803

#### **MSC – Ireland**

Gort Road Business Park,  
Ennis, Co. Clare, Ireland  
Tel: +353 (0) 65 6840044  
Fax: +353 (0) 65 6822298

**Website:**

[www.microsemi.com](http://www.microsemi.com)

**MECHANICAL and PACKAGING**

- CASE: Hermetically sealed glass package.
- TERMINALS: Tin/lead plated or RoHS compliant matte-tin (on commercial grade only) over copper clad steel. Solderable per MIL-STD-750, method 2026.
- POLARITY: Cathode indicated by band.
- MARKING: Part number.
- TAPE & REEL option: Standard per EIA-296. Consult factory for quantities.
- WEIGHT: Approximately 0.2 grams.
- See [Package Dimensions](#) on last page.

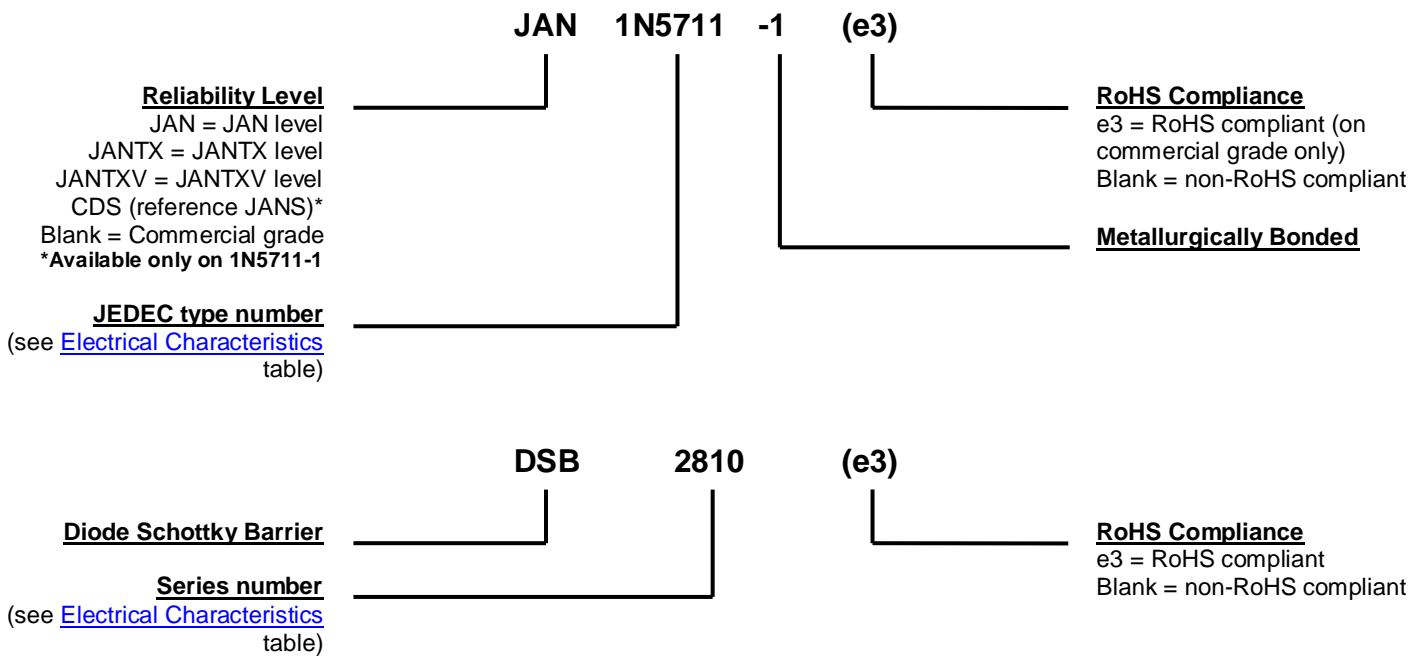
**PART NOMENCLATURE**

**SYMBOLS & DEFINITIONS**

Symbol	Definition
C	Capacitance: The capacitance in pF at a frequency of 1 MHz and specified voltage.
f	frequency
$I_R$	Reverse Current: The dc current flowing from the external circuit into the cathode terminal at the specified voltage $V_R$ .
$I_o$	Average Rectified Output Current: The Output Current averaged over a full cycle with a 50 Hz or 60 Hz sine-wave input and a 180 degree conduction angle.
$t_{rr}$	Reverse Recovery Time: The time interval between the instant the current passes through zero when changing from the forward direction to the reverse direction and a specified decay point after a peak reverse current occurs.
$V_{(BR)}$	Breakdown Voltage: A voltage in the breakdown region.
$V_F$	Forward Voltage: A positive dc anode-cathode voltage the device will exhibit at a specified forward current.
$V_R$	Reverse Voltage: A positive dc cathode-anode voltage below the breakdown region.
$V_{RWM}$	Working Peak Reverse Voltage: The peak voltage excluding all transient voltages (ref JEESD282-B). Also sometimes known historically as PIV.

**ELECTRICAL CHARACTERISTICS @ 25 °C unless otherwise noted**

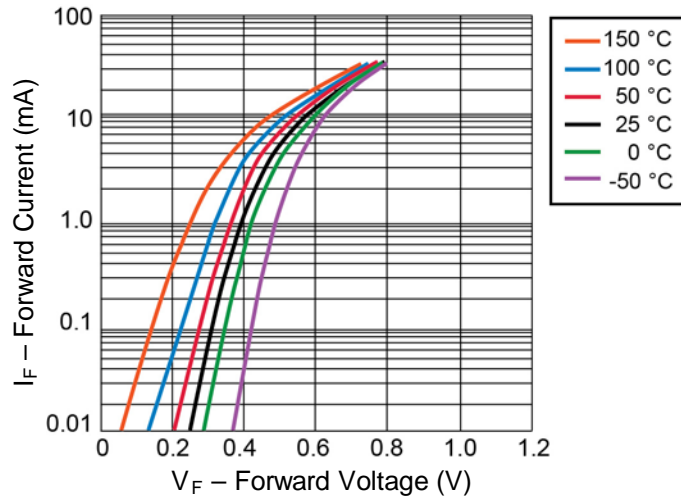
TYPE NUMBER	MINIMUM BREAKDOWN VOLTAGE	MAXIMUM FORWARD VOLTAGE	MAXIMUM FORWARD VOLTAGE	WORKING PEAK REVERSE VOLTAGE	MAXIMUM REVERSE LEAKAGE CURRENT		MAXIMUM CAPACITANCE @ $V_R = 0$ VOLTS $f = 1.0$ MHz
	$V_{(BR)}$ @ 10 $\mu$ A	$V_F$ @ 1 mA	$V_F$ @ $I_F$	$V_{RWM}$	$I_R$ @ $V_R$		C
	Volts	Volts	V @ mA	V (pk)	nA	Volts	pF
1N5711-1	70	0.41	1.0 @ 15	50	200	50	2.0
1N5712-1	20	0.41	1.0 @ 35	16	150	16	2.0
1N6857-1	20	0.35	0.75 @ 35	16	150	16	4.5
1N6858-1	70	0.36	0.65 @ 15	50	200	50	4.5
DSB2810	20	0.41	1.0 @ 35	16	100	15	2.0
DSB5712	20	0.41	1.0 @ 35	16	150	16	2.0

**GRAPHS**

**FIGURE 1**

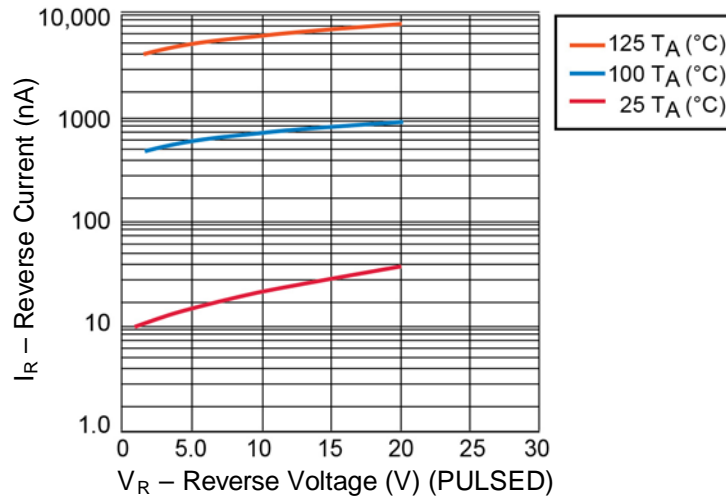
I-V Curve showing typical Forward Voltage Variation Temperature for the 1N5712-1, DSB5712 and DSB2810 Schottky Diodes

**FIGURE 2**

1N5712-1, DSB5712 and DSB2810 Typical variation of Reverse Current ( $I_R$ ) vs Reverse Voltage ( $V_R$ ) at Various Temperatures

**GRAPHS**

**FIGURE 3**  
I – V curve showing typical Forward Voltage Variation  
With Temperature Schottky Diode 1N5711

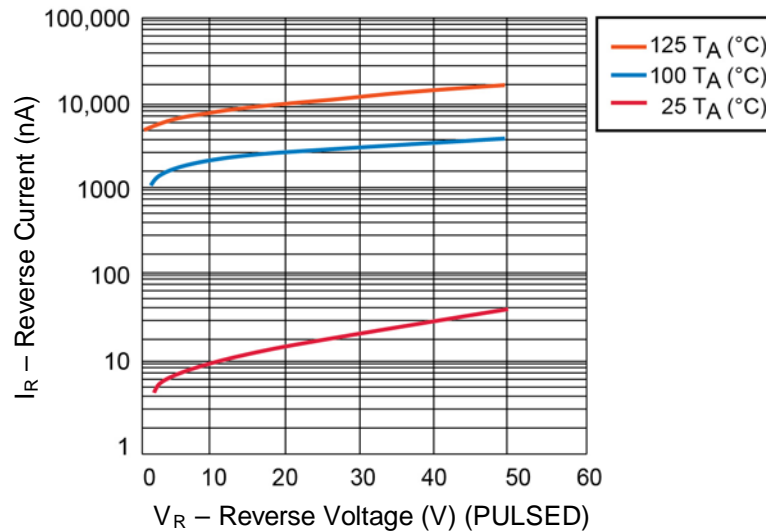
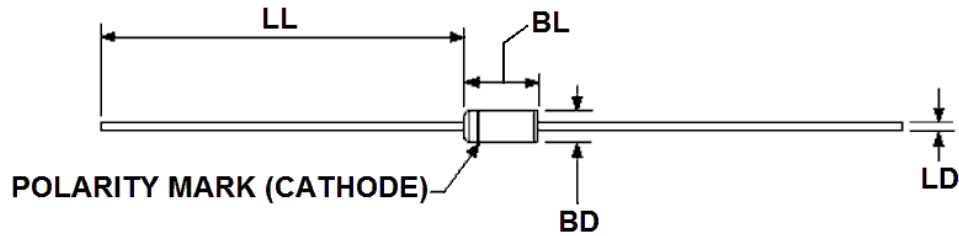

**FIGURE 4**  
1N5711 Typical Variation of Reverse Current ( $I_R$ ) vs Reverse Voltage ( $V_R$ )  
at Various Temperatures

GRAPHS



**FIGURE 5**  
Typical Dynamic Resistance ( $R_D$ ) vs Forward Current ( $I_F$ )

**PACKAGE DIMENSIONS**

**NOTES:**

1. Dimensions are in inches. Millimeters are given for information only.
2. Dimensions BL and LD includes all components of the diode periphery expect the section of the leads over which the diameter is controlled.
3. Dimension BD shall be measured at the largest diameter.
4. In accordance with ASME Y1.4M, diameters are equivalents to  $\phi$ x symbology.

Symbol	Dimensions				Notes
	Inches		Millimeters		
	Min	Max	Min	Max	
<b>BD</b>	0.068	0.076	1.73	1.93	2,3
<b>BL</b>	0.125	0.170	3.18	4.32	2
<b>LD</b>	0.014	0.022	0.36	0.56	
<b>LL</b>	1.000	1.500	25.40	38.10	

# Mouser Electronics

Authorized Distributor

Click to View Pricing, Inventory, Delivery & Lifecycle Information:

## Microchip:

[1N5712](#) [1N5712-1](#) [1N6857-1](#) [1N6858UR-1](#) [1N6858-1](#) [1N6857UR-1](#) [CDLL2810/TR](#) [JANTX1N5712-1/TR](#) [1N6858-1/TR](#) [JANTXV1N5711-1/TR](#) [JAN1N5712-1/TR](#) [CDLL2810e3/TR](#) [CDLL2810e3](#) [JAN1N5711-1/TR](#) [1N6857-1/TR](#) [1N5712/TR](#) [1N5712-1/TR](#) [1N5712-1E3](#) [1N5711e3](#) [1N5712-1E3/TR](#) [1N5711e3/TR](#) [1N5711/TR](#) [1N5711-1/TR](#)





Компания «ЭлектроПласт» предлагает заключение долгосрочных отношений при поставках импортных электронных компонентов на взаимовыгодных условиях!

Наши преимущества:

- Оперативные поставки широкого спектра электронных компонентов отечественного и импортного производства напрямую от производителей и с крупнейших мировых складов;
- Поставка более 17-ти миллионов наименований электронных компонентов;
- Поставка сложных, дефицитных, либо снятых с производства позиций;
- Оперативные сроки поставки под заказ (от 5 рабочих дней);
- Экспресс доставка в любую точку России;
- Техническая поддержка проекта, помощь в подборе аналогов, поставка прототипов;
- Система менеджмента качества сертифицирована по Международному стандарту ISO 9001;
- Лицензия ФСБ на осуществление работ с использованием сведений, составляющих государственную тайну;
- Поставка специализированных компонентов (Xilinx, Altera, Analog Devices, Intersil, Interpoint, Microsemi, Aeroflex, Peregrine, Syfer, Eurofarad, Texas Instrument, Miteq, Cobham, E2V, MA-COM, Hittite, Mini-Circuits, General Dynamics и др.);

Помимо этого, одним из направлений компании «ЭлектроПласт» является направление «Источники питания». Мы предлагаем Вам помощь Конструкторского отдела:

- Подбор оптимального решения, техническое обоснование при выборе компонента;
- Подбор аналогов;
- Консультации по применению компонента;
- Поставка образцов и прототипов;
- Техническая поддержка проекта;
- Защита от снятия компонента с производства.



#### Как с нами связаться

**Телефон:** 8 (812) 309 58 32 (многоканальный)

**Факс:** 8 (812) 320-02-42

**Электронная почта:** [org@eplast1.ru](mailto:org@eplast1.ru)

**Адрес:** 198099, г. Санкт-Петербург, ул. Калинина, дом 2, корпус 4, литера А.