

Capacitive switch



CPS
 Ring illumination
 green



CPS
 Surface backlighting
 red



CPS
 Ring illumination
 blue

See below:
[Approvals and Compliances](#)

Description

- Capacitive touch sensor as momentary push button (NO or NC) or as latching switch (LA)
- Protection against unintended switching
- Multicolor illumination
- Floating switch connections
- Laser lettering possible
- Vandal resistant
- Wires (8 wires for Multicolor, 4 wires otherwise)²; 26AWG, 0.128 mm²

Unique Selling Proposition

- Variable supply voltage
- Constant LED intensity
- Inputs protected against overvoltage
- Galvanic separated outputs

Important information

- The CPS is not suitable for use in sanitary or other applications exposed to water or other liquids.
- The housing is connected to gnd.

Characteristics

- Housing made from stainless steel
- Various illumination colors and color combinations possible
- Touch surface made from scratch-resistant ceramics with area illumination or made from stainless steel with ring illumination
- Ring or area illumination
- Wearless, no moving parts
- Attractive design with or without finger guide available

Weblinks

[pdf data sheet](#), [html datasheet](#), [General Product Information](#), [CAD-Drawings](#), [Product News](#), [Detailed request for product](#), [Microsite](#)

Technical Data

Electrical Data

Switching Function	momentary (NO ¹) or latching
Switching Voltage	max. 42 VAC / 60 VDC
Switching Current	max. 100 mA
Electrical Rating	1 W
Switch Resistance OFF	> 10 MΩ
Switch Resistance ON	< 16Ω
Supply Voltage	5 - 28 VDC
Current Consumption all LEDs off	2.5 mA (switch is open)
	8.5 mA (switch is closed)
Current Consumption 1 LED on	8.0 mA (switch is open)
	14.0 mA (switch is closed)
Current Consumption 2 LED on	14.0 mA (switch is open)
	20.0 mA (switch is closed)
Current Consumption 3 LED on	19.0 mA (switch is open)
	25.0 mA (switch is closed)
Reverse Polarity Protection	yes
Short Circuit Protection	yes
Output Type	OptoMOS Relay
Lifetime	5 million actuations
connection type	Wires (8 wires for Multicolor, 4 wires otherwise) ² ; 26AWG, 0.128 mm ²

Mechanical Data

Actuation Type	capacitive
Actuating Force	none
Shock Protection	IK 09
Mounting Depth	with Finger Guide: 30.3 mm
	without Finger Guide: 30 mm
Tightening Torque Plastic Nut	2.5 Nm

Climatical Data

Operating Temperature	-40 to 60 °C
Storage Temperature	-40 to 85 °C
IP Protection Class Front Side	IP67 acc. to IEC 60529
Salt Spray Test (acc. to DIN 50021-SS)	24 h / 48 h / 96 h Residence Time

Material

Housings	Stainless Steel
Actuator	Area Illumination: Ceramics
	Ring Illumination: Stainless steel
Illuminated Ring (Ring Illumination)	PMMA
Seal Ring	NBR70

¹ on request also available as NC / ² on request also available with cable or connector

Approvals and Compliances

Detailed information on product approvals, code requirements, usage instructions and detailed test conditions can be looked up in [Details about Approvals](#)

SCHURTER products are designed for use in industrial environments. They have approvals from independent testing bodies according to national and international standards. Products with specific characteristics and requirements such as required in the automotive sector according to IATF 16949, medical technology according to ISO 13485 or in the aerospace industry can be offered exclusively with customer-specific, individual agreements by SCHURTER.



Application standards

Application standards where the product can be used

Organization	Design	Standard	Description
	Designed for applications acc.	IEC/UL 62368-1	IEC 62368-1 includes the basic requirements for safety of audio, video, information technology and office equipment.

Compliances

The product complies with following Guide Lines

Identification	Details	Initiator	Description
	RoHS	SCHURTER AG	Directive RoHS 2011/65/EU, Amendment (EU) 2015/863
	REACH	SCHURTER AG	On 1 June 2007, Regulation (EC) No 1907/2006 on the Registration, Evaluation, Authorization and Restriction of Chemicals 1 (abbreviated as "REACH") entered into force.

Dimension [mm]

CPS with ring illuminating, with finger guide

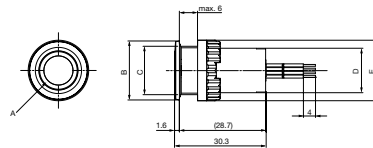

CPS with ring illuminating, no finger guide

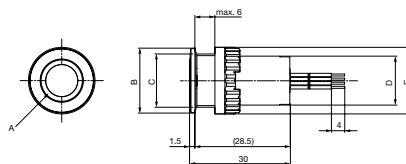

CPS with area illuminating, with finger guide

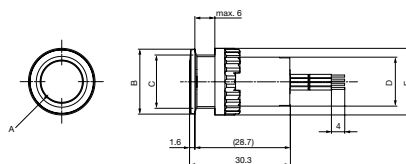

CPS with area illuminating, no finger guide

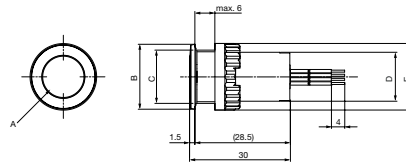

- A= illuminating area
- B= CPS16: 19.5 mm
- C= CPS16: M16x1
- D= CPS16: 14.7 mm
- E= CPS16: $\varnothing 20$ mm
- CPS19: 23.0 mm
- CPS19: M19x0.75
- CPS19: 14.5 mm
- CPS19: $\varnothing 24$ mm
- CPS22: 25.5 mm
- CPS22: M22x1
- CPS22: 14.5 mm
- CPS22: $\varnothing 27.6$ mm

For multicolor configurations

Connection wire assignment		
Wire-number	Wire color	function
Wire 1	brown	Vin = 5 VDC...28 VDC
Wire 2	black	GND
Wire 3	white	OUT1
Wire 4	white	OUT2
Wire 5	red	LED red GND = ON Open* = OFF
Wire 6	green	LED green GND = ON Open* = OFF
Wire 7	blue	LED blue GND = ON Open* = OFF
Wire 8	black	GND

For all other configurations

Connection wire assignment		
Wire-number	Wire color	function
Wire 1	brown	Vin = 5 VDC...28 VDC
Wire 2	black	GND
Wire 3	white	OUT1
Wire 4	white	OUT2

* internal pull-up resistor to vcc = 3.3 V

Dimension

CPS16

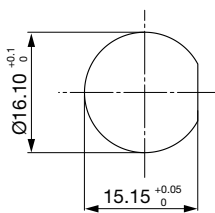

CPS19

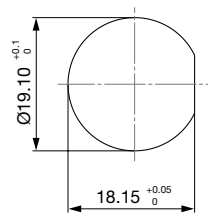

CPS22

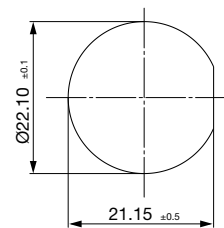

Diagrams

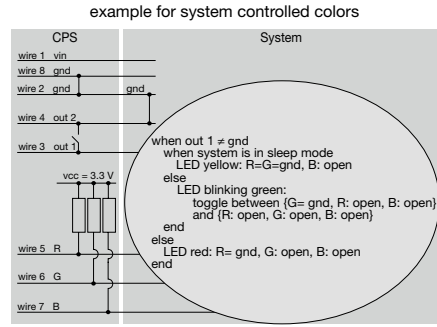
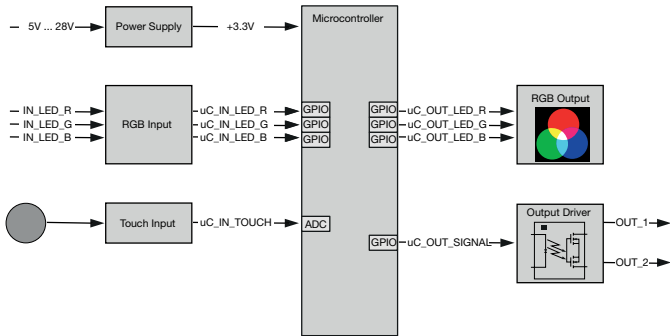

Multicolor variant





Illumination options for RGB

Lighting type	Wire red	Wire green	Wire blue	Resulting Color
Multicolor Singlecolor	x			Red
Multicolor Singlecolor		x		Green
Multicolor Singlecolor			x	Blue
Multicolor RGB Additive 2	x	x		Yellow
Multicolor RGB Additive 2	x		x	Magenta
Multicolor RGB Additive 2		x	x	Cyan
Multicolor RGB Additive 3	x	x	x	White

Lettering Colour of Laser Lettering

Material	Lettering Colour
Stainless Steel	black Filled letters
Ceramic	black Filled letters

Order Index Lettering

Laser Marking			
001 = A	021 = U	041 = ÷	061 = EIN
002 = B	022 = V	042 = *	062 = AUS
003 = C	023 = W	043 = =	063 = AUF
004 = D	024 = X	044 = #	064 = AB
005 = E	025 = Y	045 = ↔	065 = ON
006 = F	026 = Z	046 = †	066 = OFF
007 = G	027 = 0	047 = →	067 = UP
008 = H	028 = 1	048 = ←	068 = DOWN
009 = I	029 = 2	049 = ↓	069 = HIGH
010 = J	030 = 3	050 = ↑	070 = LOW
011 = K	031 = 4	051 = %	071 = ON/OFF
012 = L	032 = 5	052 = √	072 = START
013 = M	033 = 6	053 = CTRL	073 = RESET
014 = N	034 = 7	054 = RETURN	074 = 
015 = O	035 = 8	055 = SHIFT	075 = 
016 = P	036 = 9	056 = LOCK	076 = 
017 = Q	037 = + 	057 = STOP	077 = 
018 = R	038 = -	058 = ENTER	
019 = S	039 = .	059 = BACK	
020 = T	040 = x	060 = LINE	

Configuration code for configuring customized variants (example)

For customized variants a minimum order quantity of 100 pieces has to be fulfilled.

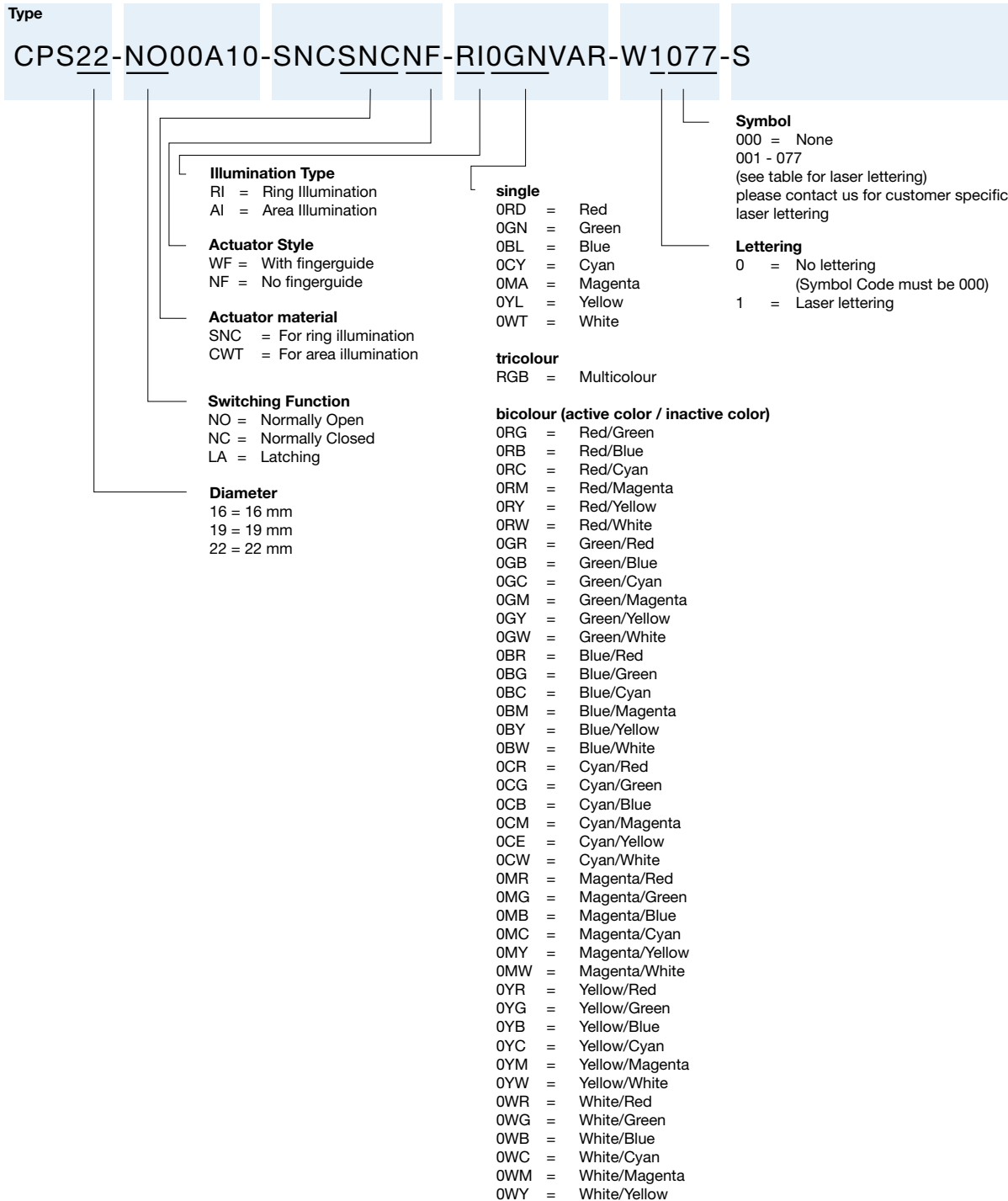

All Variants

Diameter [mm]	Illumination	Illumination Color active / inactive	Finger Guide	Function	Actuator Material	Accessories	Order Number
16	Backlighted	red / green	with	latching	Ceramics	Knurled nut	3-101-398
16	Backlighted	red / green	without	latching	Ceramics	Knurled nut	3-101-395
16	Backlighted	multicolor	without	latching	Ceramics	Knurled nut	3-101-394
16	Ring Illumination	red / green	with	latching	Stainless Steel	Knurled nut	3-101-413
16	Ring Illumination	red / green	without	latching	Stainless Steel	Knurled nut	3-101-401
16	Ring Illumination	multicolor	without	latching	Stainless Steel	Knurled nut	3-101-400
16	Backlighted	multicolor	with	momentary (NO)	Ceramics	Knurled nut	3-101-397
16	Backlighted	multicolor	without	momentary (NO)	Ceramics	Knurled nut	3-101-403
16	Ring Illumination	multicolor	with	momentary (NO)	Stainless Steel	Knurled nut	3-101-412
16	Ring Illumination	multicolor	without	momentary (NO)	Stainless Steel	Knurled nut	3-101-399
19	Backlighted	red / green	with	latching	Ceramics	Hexnut	3-101-418
19	Backlighted	red / green	without	latching	Ceramics	Hexnut	3-101-416
19	Backlighted	multicolor	without	latching	Ceramics	Hexnut	3-101-415
19	Ring Illumination	red / green	with	latching	Stainless Steel	Hexnut	3-101-423
19	Ring Illumination	red / green	without	latching	Stainless Steel	Hexnut	3-101-421
19	Ring Illumination	multicolor	without	latching	Stainless Steel	Hexnut	3-101-420
19	Backlighted	multicolor	with	momentary (NO)	Ceramics	Hexnut	3-101-417
19	Backlighted	multicolor	without	momentary (NO)	Ceramics	Hexnut	3-101-414
19	Ring Illumination	multicolor	with	momentary (NO)	Stainless Steel	Hexnut	3-101-422
19	Ring Illumination	multicolor	without	momentary (NO)	Stainless Steel	Hexnut	3-101-419
22	Backlighted	red / green	with	latching	Ceramics	Knurled nut	3-101-428
22	Backlighted	red / green	without	latching	Ceramics	Knurled nut	3-101-426
22	Backlighted	multicolor	without	latching	Ceramics	Knurled nut	3-101-425
22	Ring Illumination	red / green	with	latching	Stainless Steel	Knurled nut	3-101-405
22	Ring Illumination	red / green	without	latching	Stainless Steel	Knurled nut	3-101-431
22	Ring Illumination	multicolor	without	latching	Stainless Steel	Knurled nut	3-101-430
22	Backlighted	multicolor	with	momentary (NO)	Ceramics	Knurled nut	3-101-427
22	Backlighted	multicolor	without	momentary (NO)	Ceramics	Knurled nut	3-101-424
22	Ring Illumination	multicolor	with	momentary (NO)	Stainless Steel	Knurled nut	3-101-404
22	Ring Illumination	multicolor	without	momentary (NO)	Stainless Steel	Knurled nut	3-101-429

Common parameters for all standard variants:

- Housing material: stainless steel
- Switching current: 100 mA
- Illumination supply voltage: 5 V - 28 V (variable)
- IP protection: IP67 - IK protection: IK09
- Terminal connection: wires (8 wires for RGB, 4 wires otherwise), standard wire length is 200 mm

Latching and momentary NO switch are open after power-up (protection against unintended switching)
 NO: normally open

 Most Popular.

Availability for all products can be searched real-time: <https://www.schurter.com/en/Stock-Check/Stock-Check-SCHURTER>

Minimum order quantity for standard variants with or without laser marking is 10 pieces.

Configurations which are not listed as standard in the table above can be requested as customized variants. The configuration code can be used for customizing this product. Please contact us in case more detail information is needed.

Packaging unit 10 Pcs



Компания «ЭлектроПласт» предлагает заключение долгосрочных отношений при поставках импортных электронных компонентов на взаимовыгодных условиях!

Наши преимущества:

- Оперативные поставки широкого спектра электронных компонентов отечественного и импортного производства напрямую от производителей и с крупнейших мировых складов;
- Поставка более 17-ти миллионов наименований электронных компонентов;
- Поставка сложных, дефицитных, либо снятых с производства позиций;
- Оперативные сроки поставки под заказ (от 5 рабочих дней);
- Экспресс доставка в любую точку России;
- Техническая поддержка проекта, помощь в подборе аналогов, поставка прототипов;
- Система менеджмента качества сертифицирована по Международному стандарту ISO 9001;
- Лицензия ФСБ на осуществление работ с использованием сведений, составляющих государственную тайну;
- Поставка специализированных компонентов (Xilinx, Altera, Analog Devices, Intersil, Interpoint, Microsemi, Aeroflex, Peregrine, Syfer, Eurofarad, Texas Instrument, Miteq, Cobham, E2V, MA-COM, Hittite, Mini-Circuits, General Dynamics и др.);

Помимо этого, одним из направлений компании «ЭлектроПласт» является направление «Источники питания». Мы предлагаем Вам помощь Конструкторского отдела:

- Подбор оптимального решения, техническое обоснование при выборе компонента;
- Подбор аналогов;
- Консультации по применению компонента;
- Поставка образцов и прототипов;
- Техническая поддержка проекта;
- Защита от снятия компонента с производства.



Как с нами связаться

Телефон: 8 (812) 309 58 32 (многоканальный)

Факс: 8 (812) 320-02-42

Электронная почта: org@eplast1.ru

Адрес: 198099, г. Санкт-Петербург, ул. Калинина, дом 2, корпус 4, литера А.