

Capacitive switch



CPS
Ring illumination
green



CPS
Surface backlighting
red



CPS
Ring illumination
blue

See below:
[Approvals and Compliances](#)

Description

- Capacitive touch sensor as momentary push button (NO or NC) or as latching switch (LA)
- Protection against unintended switching
- Multicolor illumination
- Floating switch connections
- Laser lettering possible
- Vandal resistant
- Wires (8 wires for Multicolor, 4 wires otherwise)²; 26AWG, 0.128 mm²

Unique Selling Proposition

- Variable supply voltage
- Constant LED intensity
- Inputs protected against overvoltage
- Galvanic separated outputs

Important information

- The CPS is not suitable for use in sanitary or other applications exposed to water or other liquids.
- The housing is connected to gnd.

Characteristics

- Housing made from stainless steel
- Various illumination colors and color combinations possible
- Touch surface made from scratch-resistant ceramics with area illumination or made from stainless steel with ring illumination
- Ring or area illumination
- Wearless, no moving parts
- Attractive design with or without finger guide available

Weblinks

[pdf data sheet](#), [html datasheet](#), [General Product Information](#), [CAD-Drawings](#), [Product News](#), [Detailed request for product](#), [Microsite](#)

Technical Data

Electrical Data

| | |
|----------------------------------|---|
| Switching Function | momentary (NO ¹) or latching |
| Switching Voltage | max. 42 VAC / 60 VDC |
| Switching Current | max. 100 mA |
| Electrical Rating | 1 W |
| Switch Resistance OFF | > 10 MΩ |
| Switch Resistance ON | < 16Ω |
| Supply Voltage | 5 - 28 VDC |
| Current Consumption all LEDs off | 2.5 mA (switch is open) |
| | 8.5 mA (switch is closed) |
| Current Consumption 1 LED on | 8.0 mA (switch is open) |
| | 14.0 mA (switch is closed) |
| Current Consumption 2 LED on | 14.0 mA (switch is open) |
| | 20.0 mA (switch is closed) |
| Current Consumption 3 LED on | 19.0 mA (switch is open) |
| | 25.0 mA (switch is closed) |
| Reverse Polarity Protection | yes |
| Short Circuit Protection | yes |
| Output Type | OptoMOS Relay |
| Lifetime | 5 million actuations |
| connection type | Wires (8 wires for Multicolor, 4 wires otherwise) ² ; 26AWG, 0.128 mm ² |

Mechanical Data

| | |
|-------------------------------|-----------------------------|
| Actuation Type | capacitive |
| Actuating Force | none |
| Shock Protection | IK 09 |
| Mounting Depth | with Finger Guide: 30.3 mm |
| | without Finger Guide: 30 mm |
| Tightening Torque Plastic Nut | 2.5 Nm |

Climatical Data

| | |
|--|-----------------------------------|
| Operating Temperature | -40 to 60 °C |
| Storage Temperature | -40 to 85 °C |
| IP Protection Class Front Side | IP67 acc. to IEC 60529 |
| Salt Spray Test (acc. to DIN 50021-SS) | 24 h / 48 h / 96 h Residence Time |

Material

| | |
|--------------------------------------|------------------------------------|
| Housings | Stainless Steel |
| Actuator | Area Illumination: Ceramics |
| | Ring Illumination: Stainless steel |
| Illuminated Ring (Ring Illumination) | PMMA |
| Seal Ring | NBR70 |

¹ on request also available as NC / ² on request also available with cable or connector

Approvals and Compliances

Detailed information on product approvals, code requirements, usage instructions and detailed test conditions can be looked up in [Details about Approvals](#)

SCHURTER products are designed for use in industrial environments. They have approvals from independent testing bodies according to national and international standards. Products with specific characteristics and requirements such as required in the automotive sector according to IATF 16949, medical technology according to ISO 13485 or in the aerospace industry can be offered exclusively with customer-specific, individual agreements by SCHURTER.



Application standards

Application standards where the product can be used

| Organization | Design | Standard | Description |
|--|--------------------------------|----------------|--|
|  | Designed for applications acc. | IEC/UL 62368-1 | IEC 62368-1 includes the basic requirements for safety of audio, video, information technology and office equipment. |

Compliances

The product complies with following Guide Lines

| Identification | Details | Initiator | Description |
|--|---------|-------------|---|
|  | RoHS | SCHURTER AG | Directive RoHS 2011/65/EU, Amendment (EU) 2015/863 |
|  | REACH | SCHURTER AG | On 1 June 2007, Regulation (EC) No 1907/2006 on the Registration, Evaluation, Authorization and Restriction of Chemicals 1 (abbreviated as "REACH") entered into force. |

Dimension [mm]

CPS with ring illuminating, with finger guide

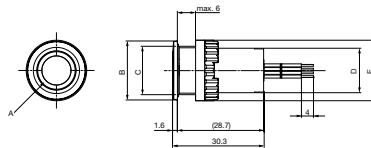

CPS with ring illuminating, no finger guide

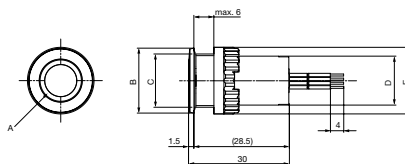

CPS with area illuminating, with finger guide

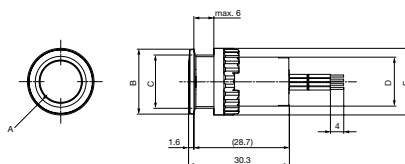

CPS with area illuminating, no finger guide

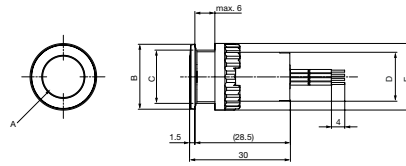

- A= illuminating area
- B= CPS16: 19.5 mm
- C= CPS16: M16x1
- D= CPS16: 14.7 mm
- E= CPS16: $\varnothing 20$ mm
- CPS19: 23.0 mm
- CPS19: M19x0.75
- CPS19: 14.5 mm
- CPS19: $\varnothing 24$ mm
- CPS22: 25.5 mm
- CPS22: M22x1
- CPS22: 14.5 mm
- CPS22: $\varnothing 27.6$ mm

For multicolor configurations

| Connection wire assignment | | |
|----------------------------|------------|--------------------------------------|
| Wire-number | Wire color | function |
| Wire 1 | brown | Vin = 5 VDC...28 VDC |
| Wire 2 | black | GND |
| Wire 3 | white | OUT1 |
| Wire 4 | white | OUT2 |
| Wire 5 | red | LED red GND = ON Open* = OFF |
| Wire 6 | green | LED green GND = ON Open* = OFF |
| Wire 7 | blue | LED blue GND = ON Open* = OFF |
| Wire 8 | black | GND |

For all other configurations

| Connection wire assignment | | |
|----------------------------|------------|----------------------|
| Wire-number | Wire color | function |
| Wire 1 | brown | Vin = 5 VDC...28 VDC |
| Wire 2 | black | GND |
| Wire 3 | white | OUT1 |
| Wire 4 | white | OUT2 |

* internal pull-up resistor to vcc = 3.3 V

Dimension

CPS16

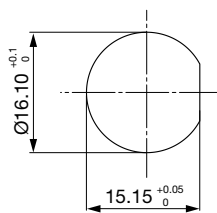

CPS19



CPS22

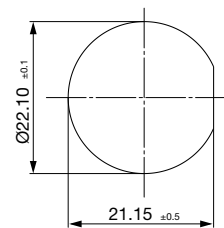

Diagrams

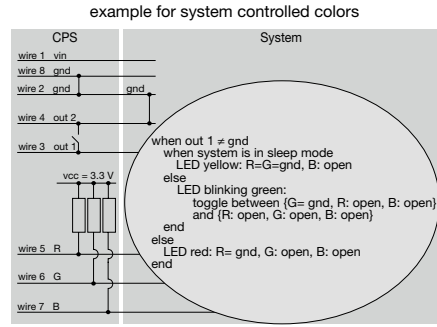

Multicolor variant





Illumination options for RGB

| Lighting type | Wire red | Wire green | Wire blue | Resulting Color |
|---------------------------|----------|------------|-----------|-----------------|
| Multicolor Singlecolor | x | | | Red |
| Multicolor Singlecolor | | x | | Green |
| Multicolor Singlecolor | | | x | Blue |
| Multicolor RGB Additive 2 | x | x | | Yellow |
| Multicolor RGB Additive 2 | x | | x | Magenta |
| Multicolor RGB Additive 2 | | x | x | Cyan |
| Multicolor RGB Additive 3 | x | x | x | White |

Lettering Colour of Laser Lettering

| Material | Lettering Colour |
|-----------------|----------------------|
| Stainless Steel | black Filled letters |
| Ceramic | black Filled letters |

Order Index Lettering

| Laser Marking | | | |
|----------------|-----------------|---------------------|---|
| 001 = A | 021 = U | 041 = ÷ | 061 = EIN |
| 002 = B | 022 = V | 042 = * | 062 = AUS |
| 003 = C | 023 = W | 043 = = | 063 = AUF |
| 004 = D | 024 = X | 044 = # | 064 = AB |
| 005 = E | 025 = Y | 045 = ↔ | 065 = ON |
| 006 = F | 026 = Z | 046 = † | 066 = OFF |
| 007 = G | 027 = 0 | 047 = → | 067 = UP |
| 008 = H | 028 = 1 | 048 = ← | 068 = DOWN |
| 009 = I | 029 = 2 | 049 = ↓ | 069 = HIGH |
| 010 = J | 030 = 3 | 050 = ↑ | 070 = LOW |
| 011 = K | 031 = 4 | 051 = % | 071 = ON/OFF |
| 012 = L | 032 = 5 | 052 = √ | 072 = START |
| 013 = M | 033 = 6 | 053 = CTRL | 073 = RESET |
| 014 = N | 034 = 7 | 054 = RETURN | 074 =  |
| 015 = O | 035 = 8 | 055 = SHIFT | 075 =  |
| 016 = P | 036 = 9 | 056 = LOCK | 076 =  |
| 017 = Q | 037 = + | 057 = STOP | 077 =  |
| 018 = R | 038 = - | 058 = ENTER | |
| 019 = S | 039 = . | 059 = BACK | |
| 020 = T | 040 = x | 060 = LINE | |

Configuration code for configuring customized variants (example)

For customized variants a minimum order quantity of 100 pieces has to be fulfilled.



All Variants

| Diameter [mm] | Illumination | Illumination Color active / inactive | Finger Guide | Function | Actuator Material | Accessories | Order Number |
|---------------|-------------------|--------------------------------------|--------------|----------------|-------------------|-------------|--------------|
| 16 | Backlighted | red / green | with | latching | Ceramics | Knurled nut | 3-101-398 |
| 16 | Backlighted | red / green | without | latching | Ceramics | Knurled nut | 3-101-395 |
| 16 | Backlighted | multicolor | without | latching | Ceramics | Knurled nut | 3-101-394 |
| 16 | Ring Illumination | red / green | with | latching | Stainless Steel | Knurled nut | 3-101-413 |
| 16 | Ring Illumination | red / green | without | latching | Stainless Steel | Knurled nut | 3-101-401 |
| 16 | Ring Illumination | multicolor | without | latching | Stainless Steel | Knurled nut | 3-101-400 |
| 16 | Backlighted | multicolor | with | momentary (NO) | Ceramics | Knurled nut | 3-101-397 |
| 16 | Backlighted | multicolor | without | momentary (NO) | Ceramics | Knurled nut | 3-101-403 |
| 16 | Ring Illumination | multicolor | with | momentary (NO) | Stainless Steel | Knurled nut | 3-101-412 |
| 16 | Ring Illumination | multicolor | without | momentary (NO) | Stainless Steel | Knurled nut | 3-101-399 |
| 19 | Backlighted | red / green | with | latching | Ceramics | Hexnut | 3-101-418 |
| 19 | Backlighted | red / green | without | latching | Ceramics | Hexnut | 3-101-416 |
| 19 | Backlighted | multicolor | without | latching | Ceramics | Hexnut | 3-101-415 |
| 19 | Ring Illumination | red / green | with | latching | Stainless Steel | Hexnut | 3-101-423 |
| 19 | Ring Illumination | red / green | without | latching | Stainless Steel | Hexnut | 3-101-421 |
| 19 | Ring Illumination | multicolor | without | latching | Stainless Steel | Hexnut | 3-101-420 |
| 19 | Backlighted | multicolor | with | momentary (NO) | Ceramics | Hexnut | 3-101-417 |
| 19 | Backlighted | multicolor | without | momentary (NO) | Ceramics | Hexnut | 3-101-414 |
| 19 | Ring Illumination | multicolor | with | momentary (NO) | Stainless Steel | Hexnut | 3-101-422 |
| 19 | Ring Illumination | multicolor | without | momentary (NO) | Stainless Steel | Hexnut | 3-101-419 |
| 22 | Backlighted | red / green | with | latching | Ceramics | Knurled nut | 3-101-428 |
| 22 | Backlighted | red / green | without | latching | Ceramics | Knurled nut | 3-101-426 |
| 22 | Backlighted | multicolor | without | latching | Ceramics | Knurled nut | 3-101-425 |
| 22 | Ring Illumination | red / green | with | latching | Stainless Steel | Knurled nut | 3-101-405 |
| 22 | Ring Illumination | red / green | without | latching | Stainless Steel | Knurled nut | 3-101-431 |
| 22 | Ring Illumination | multicolor | without | latching | Stainless Steel | Knurled nut | 3-101-430 |
| 22 | Backlighted | multicolor | with | momentary (NO) | Ceramics | Knurled nut | 3-101-427 |
| 22 | Backlighted | multicolor | without | momentary (NO) | Ceramics | Knurled nut | 3-101-424 |
| 22 | Ring Illumination | multicolor | with | momentary (NO) | Stainless Steel | Knurled nut | 3-101-404 |
| 22 | Ring Illumination | multicolor | without | momentary (NO) | Stainless Steel | Knurled nut | 3-101-429 |

Common parameters for all standard variants:

- Housing material: stainless steel
- Switching current: 100 mA
- Illumination supply voltage: 5 V - 28 V (variable)
- IP protection: IP67 - IK protection: IK09
- Terminal connection: wires (8 wires for RGB, 4 wires otherwise), standard wire length is 200 mm

Latching and momentary NO switch are open after power-up (protection against unintended switching)
 NO: normally open

 Most Popular.

Availability for all products can be searched real-time: <https://www.schurter.com/en/Stock-Check/Stock-Check-SCHURTER>

Minimum order quantity for standard variants with or without laser marking is 10 pieces.

Configurations which are not listed as standard in the table above can be requested as customized variants. The configuration code can be used for customizing this product. Please contact us in case more detail information is needed.

Packaging unit 10 Pcs



Компания «ЭлектроПласт» предлагает заключение долгосрочных отношений при поставках импортных электронных компонентов на взаимовыгодных условиях!

Наши преимущества:

- Оперативные поставки широкого спектра электронных компонентов отечественного и импортного производства напрямую от производителей и с крупнейших мировых складов;
- Поставка более 17-ти миллионов наименований электронных компонентов;
- Поставка сложных, дефицитных, либо снятых с производства позиций;
- Оперативные сроки поставки под заказ (от 5 рабочих дней);
- Экспресс доставка в любую точку России;
- Техническая поддержка проекта, помощь в подборе аналогов, поставка прототипов;
- Система менеджмента качества сертифицирована по Международному стандарту ISO 9001;
- Лицензия ФСБ на осуществление работ с использованием сведений, составляющих государственную тайну;
- Поставка специализированных компонентов (Xilinx, Altera, Analog Devices, Intersil, Interpoint, Microsemi, Aeroflex, Peregrine, Syfer, Eurofarad, Texas Instrument, Miteq, Cobham, E2V, MA-COM, Hittite, Mini-Circuits, General Dynamics и др.);

Помимо этого, одним из направлений компании «ЭлектроПласт» является направление «Источники питания». Мы предлагаем Вам помощь Конструкторского отдела:

- Подбор оптимального решения, техническое обоснование при выборе компонента;
- Подбор аналогов;
- Консультации по применению компонента;
- Поставка образцов и прототипов;
- Техническая поддержка проекта;
- Защита от снятия компонента с производства.



Как с нами связаться

Телефон: 8 (812) 309 58 32 (многоканальный)

Факс: 8 (812) 320-02-42

Электронная почта: org@eplast1.ru

Адрес: 198099, г. Санкт-Петербург, ул. Калинина, дом 2, корпус 4, литера А.