

Current-compensated Chokes



- | Rated currents from 0.3 to 10 A
- | DC to 400 Hz frequency
- | 100 kHz to 3 MHz common-mode resonance frequency
- | Dual-choke configurations
- | Multiple PCB-mounting options



Performance indicators



Technical specifications

| | |
|--|--|
| Operating voltage | 300 VAC |
| Operating frequency | DC to 400 Hz |
| Rated currents | 0.3 to 10 A @ rated ambient temperature |
| Rated inductance | 0.4 to 100 mH |
| Stray inductance | Typically 1% of L_N |
| Inductance reduction (DC bias with IN) | Less than 10% (25°C) |
| High potential test voltage winding-to-winding @ 25°C | 1500 VAC, 60 sec, guaranteed 1500 VAC, 2 sec, factory test |
| winding-to-housing @ 25°C | 4000 VAC, 60 sec, guaranteed |
| MTBF @ 40°C/230 V (Mil-HB-217F) | >5,000,000 hours |
| Surge current @ 10 msec | 20 x I_N @ 25°C |
| Temperature range (operation and storage) | -40°C to 100°C (40/100/56) acc. IEC 60068-1 |
| Flammability corresponding to | Potting compound UL 94V-0 Housing UL 94V-0 Ringcore coating UL 94V-0 |
| Design corresponding to | UL 1283, IEC/EN 60938-1 |

Approvals & Compliances



RN chokes are attenuating common-mode or asymmetric (P/N → E) interference signals, by being connected in series with the phase and neutral lines of an AC powerline input. Symmetrical components of the noise are also attenuated by the leakage inductance (stray inductance) of the windings. These chokes are typically used in conjunction with suppression capacitors.

Features and benefits

- | High saturation resistance and excellent thermal behavior
- | Through hole pin connections
- | Dual-choke configuration
- | Small compact design
- | Multiple housing options
- | Custom-specific versions are available on request
- | Higher temperature versions
- | Fully potted design usable for ruggedized applications

Typical applications

- | Switch-mode power applications
- | Suppressing common-mode interference levels
- | EMI input filters
- | For suppression-equipment with no earth connection
- | Phase-angle control circuits in combination with saturating chokes

Typical electrical schematic

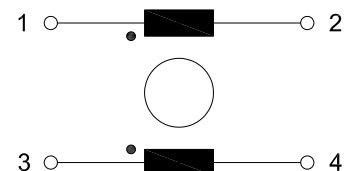

Choke selection table

| Choke | Current (I _N) [A] | @ ambient temperature [°C] | Inductance (L _N) [mH] | Resistance (R _{DC}) [mOhm] | A [mm] | B [mm] | H [mm] | Weight (g) | |
|-------------------|-------------------------------------|----------------------------------|---|--|-----------|-----------|-----------|---------------|---------------------|
| RN 102-0.3-02-22M | 0.3 | 40 | 22.0 | 1300 | 10.0 | 10.0 | 9.0 | 4 | buy |
| RN 102-0.3-02-12M | 0.3 | 40 | 12.0 | 1100 | 10.0 | 10.0 | 9.0 | 3 | buy |
| RN 102-0.6-02-4M4 | 0.6 | 40 | 4.4 | 380 | 10.0 | 10.0 | 9.0 | 3 | |
| RN 102-1-02-3M0 | 1.0 | 40 | 3.0 | 210 | 10.0 | 10.0 | 9.0 | 3 | |
| RN 102-1.5-02-1M6 | 1.5 | 40 | 1.6 | 94 | 10.0 | 10.0 | 9.0 | 3 | |
| RN 102-2-02-1M1 | 2.0 | 40 | 1.1 | 70 | 10.0 | 10.0 | 9.0 | 3 | |
| RN 112-0.4-02-39M | 0.4 | 40 | 39.0 | 1500 | 15.0 | 10.0 | 12.6 | 6 | |
| RN 112-0.4-02-27M | 0.4 | 40 | 27.0 | 1400 | 15.0 | 10.0 | 12.6 | 6 | |
| RN 112-0.5-02-27M | 0.5 | 40 | 27.0 | 1200 | 15.0 | 10.0 | 12.6 | 6 | |
| RN 112-0.5-02-18M | 0.5 | 40 | 18.0 | 1100 | 15.0 | 10.0 | 12.6 | 6 | |
| RN 112-0.5-02-15M | 0.5 | 40 | 15.0 | 700 | 15.0 | 10.0 | 12.6 | 6 | |
| RN 112-0.6-02-15M | 0.6 | 40 | 15.0 | 490 | 15.0 | 10.0 | 12.6 | 6 | |
| RN 112-0.8-02-10M | 0.8 | 40 | 10.0 | 380 | 15.0 | 10.0 | 12.6 | 6 | |
| RN 112-1.2-02-6M8 | 1.2 | 40 | 6.8 | 250 | 15.0 | 10.0 | 12.6 | 6 | |
| RN 112-1.5-02-3M3 | 1.5 | 40 | 3.3 | 102 | 15.0 | 10.0 | 12.6 | 6 | |
| RN 112-2-02-1M8 | 2.0 | 40 | 1.8 | 74 | 15.0 | 10.0 | 12.6 | 6 | |
| RN 112-2-02-1M0 | 2.0 | 40 | 1.0 | 70 | 15.0 | 10.0 | 12.6 | 6 | |
| RN 112-2.6-02-0M4 | 2.6 | 40 | 0.4 | 40 | 15.0 | 10.0 | 12.6 | 6 | |
| RN 112-3.6-02-0M4 | 3.6 | 40 | 0.4 | 27 | 15.0 | 10.0 | 12.6 | 6 | |
| RN 112-4-02-0M7 | 4.0 | 40 | 0.7 | 24 | 15.0 | 10.0 | 12.6 | 6 | |
| RN 114-0.3-02-47M | 0.3 | 40 | 47.0 | 1700 | 20.1 | 12.5 | 13.2 | 10 | |
| RN 114-0.5-02-39M | 0.5 | 40 | 39.0 | 830 | 20.1 | 12.5 | 13.2 | 11 | |
| RN 114-0.8-02-27M | 0.8 | 40 | 27.0 | 500 | 20.1 | 12.5 | 13.2 | 11 | |
| RN 114-1-02-15M | 1.0 | 40 | 15.0 | 370 | 20.1 | 12.5 | 13.2 | 10 | |
| RN 114-1.2-02-10M | 1.2 | 40 | 10.0 | 195 | 20.1 | 12.5 | 13.2 | 10 | |
| RN 114-1.5-02-6M8 | 1.5 | 40 | 6.8 | 123 | 20.1 | 12.5 | 13.2 | 11 | |
| RN 114-2-02-4M2 | 2.0 | 40 | 4.2 | 100 | 20.1 | 12.5 | 13.2 | 11 | |
| RN 114-2.5-02-3M3 | 2.5 | 40 | 3.3 | 72 | 20.1 | 12.5 | 13.2 | 11 | |
| RN 114-3-02-2M0 | 3.0 | 40 | 2.0 | 52 | 20.1 | 12.5 | 13.2 | 10 | |
| RN 114-4-02-1M5 | 4.0 | 40 | 1.5 | 34 | 20.1 | 12.5 | 13.2 | 11 | |
| RN 116-0.5-02-47M | 0.5 | 60 | 47.0 | 960 | 20.1 | 12.5 | 13.2 | 11 | |
| RN 116-0.5-02-39M | 0.5 | 60 | 39.0 | 920 | 20.1 | 12.5 | 13.2 | 11 | |
| RN 116-0.5-02-27M | 0.5 | 60 | 27.0 | 790 | 20.1 | 12.5 | 13.2 | 11 | |
| RN 116-0.8-02-27M | 0.8 | 60 | 27.0 | 370 | 20.1 | 12.5 | 13.2 | 13 | |
| RN 116-1-02-15M | 1.0 | 60 | 15.0 | 260 | 20.1 | 12.5 | 13.2 | 12 | |
| RN 116-1-02-10M | 1.0 | 60 | 10.0 | 210 | 20.1 | 12.5 | 13.2 | 11 | |
| RN 116-1.3-02-6M8 | 1.3 | 60 | 6.8 | 140 | 20.1 | 12.5 | 13.2 | 12 | |
| RN 116-1.5-02-10M | 1.5 | 60 | 10.0 | 148 | 20.1 | 12.5 | 13.2 | 12 | |
| RN 116-1.7-02-4M0 | 1.7 | 60 | 4.0 | 87 | 20.1 | 12.5 | 13.2 | 12 | |
| RN 116-2-02-3M3 | 2.0 | 60 | 3.3 | 70 | 20.1 | 12.5 | 13.2 | 12 | |
| RN 116-2-02-2M2 | 2.0 | 60 | 2.2 | 66 | 20.1 | 12.5 | 13.2 | 11 | |
| RN 122-0.5-02-56M | 0.5 | 40 | 56.0 | 1800 | 25.0 | 15.0 | 16.5 | 20 | |
| RN 122-0.6-02-47M | 0.6 | 40 | 47.0 | 1300 | 25.0 | 15.0 | 16.5 | 20 | |
| RN 122-0.8-02-39M | 0.8 | 40 | 39.0 | 1000 | 25.0 | 15.0 | 16.5 | 20 | |
| RN 122-1-02-18M | 1.0 | 40 | 18.0 | 630 | 25.0 | 15.0 | 16.5 | 19 | |
| RN 122-1-02-10M | 1.0 | 40 | 10.0 | 560 | 25.0 | 15.0 | 16.5 | 19 | |
| RN 122-1.5-02-10M | 1.5 | 40 | 10.0 | 250 | 25.0 | 15.0 | 16.5 | 20 | |
| RN 122-2-02-6M8 | 2.0 | 40 | 6.8 | 156 | 25.0 | 15.0 | 16.5 | 20 | |
| RN 122-2-02-5M0 | 2.0 | 40 | 5.0 | 140 | 25.0 | 15.0 | 16.5 | 21 | |
| RN 122-2.5-02-5M6 | 2.5 | 40 | 5.6 | 110 | 25.0 | 15.0 | 16.5 | 20 | |
| RN 122-3-02-4M5 | 3.0 | 40 | 4.5 | 80 | 25.0 | 15.0 | 16.5 | 21 | |
| RN 122-4-02-3M3 | 4.0 | 40 | 3.3 | 46 | 25.0 | 15.0 | 16.5 | 22 | |
| RN 122-4-02-1M8 | 4.0 | 40 | 1.8 | 42 | 25.0 | 15.0 | 16.5 | 22 | |

| Choke | Current (In) [A] | @ ambient temperature [°C] | Inductance (LN) [mH] | Resistance (Rdc) [mOhm] | A [mm] | B [mm] | H [mm] | Weight (g) |
|--------------------|------------------------|----------------------------------|----------------------------|-------------------------------|-----------|-----------|-----------|---------------|
| RN 142-0.5-02-82M | 0.5 | 40 | 82.0 | 2700 | 30.0 | 20.0 | 19.7 | 36 |
| RN 142-1-02-33M | 1.0 | 40 | 33.0 | 810 | 30.0 | 20.0 | 19.7 | 37 |
| RN 142-1.4-02-27M | 1.4 | 40 | 27.0 | 500 | 30.0 | 20.0 | 19.7 | 40 |
| RN 142-2-02-6M8 | 2.0 | 40 | 6.8 | 192 | 30.0 | 20.0 | 19.7 | 36 |
| RN 142-4-02-3M3 | 4.0 | 40 | 3.3 | 67 | 30.0 | 20.0 | 19.7 | 38 |
| RN 142-6-02-1M8 | 6.0 | 40 | 1.8 | 20 | 30.0 | 20.0 | 19.7 | 40 |
| RN 143-0.5-02-100M | 0.5 | 40 | 100.0 | 2900 | 30.0 | 20.0 | 19.7 | 36 |
| RN 143-1-02-47M | 1.0 | 40 | 47.0 | 890 | 30.0 | 20.0 | 19.7 | 38 |
| RN 143-2-02-10M | 2.0 | 40 | 10.0 | 240 | 30.0 | 20.0 | 19.7 | 42 |
| RN 143-4-02-3M9 | 4.0 | 40 | 3.9 | 59 | 30.0 | 20.0 | 19.7 | 39 |
| RN 143-6-02-1M8 | 6.0 | 40 | 1.8 | 20 | 30.0 | 20.0 | 19.7 | 42 |
| RN 152-1-02-68M | 1.0 | 40 | 68.0 | 1300 | 40.0 | 15.0 | 25.0 | 75 |
| RN 152-2-02-18M | 2.0 | 40 | 18.0 | 350 | 40.0 | 15.0 | 25.0 | 64 |
| RN 152-4-02-6M8 | 4.0 | 40 | 6.8 | 87 | 40.0 | 15.0 | 25.0 | 74 |
| RN 152-6-02-3M9 | 6.0 | 40 | 3.9 | 42 | 40.0 | 15.0 | 25.0 | 68 |
| RN 152-8-02-2M7 | 8.0 | 40 | 2.7 | 22 | 40.0 | 15.0 | 25.0 | 73 |
| RN 152-10-02-1M8 | 10.0 | 40 | 1.8 | 14 | 40.0 | 15.0 | 25.0 | 73 |
| RN 202-0.3-02-22M | 0.3 | 40 | 22.0 | 1300 | 5.1 | 15.2 | 13.5 | 4 |
| RN 202-0.3-02-12M | 0.3 | 40 | 12.0 | 1100 | 5.1 | 15.2 | 13.5 | 4 |
| RN 202-0.6-02-4M4 | 0.6 | 40 | 4.4 | 380 | 5.1 | 15.2 | 13.5 | 4 |
| RN 202-1-02-3M0 | 1.0 | 40 | 3.0 | 210 | 5.1 | 15.2 | 13.5 | 4 |
| RN 202-1.5-02-1M6 | 1.5 | 40 | 1.6 | 94 | 5.1 | 15.2 | 13.5 | 4 |
| RN 202-2-02-1M1 | 2.0 | 40 | 1.1 | 70 | 5.1 | 15.2 | 13.5 | 4 |
| RN 204-0.3-02-22M | 0.3 | 40 | 22.0 | 1300 | 7.6 | 10.0 | 14.3 | 3 |
| RN 204-0.3-02-12M | 0.3 | 40 | 12.0 | 960 | 7.6 | 10.0 | 14.3 | 3 |
| RN 204-0.6-02-4M4 | 0.6 | 40 | 4.4 | 350 | 7.6 | 10.0 | 14.3 | 3 |
| RN 204-1-02-3M0 | 1.0 | 40 | 3.0 | 192 | 7.6 | 10.0 | 14.3 | 3 |
| RN 204-1.5-02-1M6 | 1.5 | 40 | 1.6 | 96 | 7.6 | 10.0 | 14.3 | 3 |
| RN 204-2-02-1M1 | 2.0 | 40 | 1.1 | 57 | 7.6 | 10.0 | 14.3 | 3 |
| RN 212-0.4-02-39M | 0.4 | 40 | 39.0 | 1500 | 10.0 | 15.0 | 20.0 | 8 |
| RN 212-0.4-02-27M | 0.4 | 40 | 27.0 | 1400 | 10.0 | 15.0 | 20.0 | 8 |
| RN 212-0.5-02-27M | 0.5 | 40 | 27.0 | 1200 | 10.0 | 15.0 | 20.0 | 8 |
| RN 212-0.5-02-18M | 0.5 | 40 | 18.0 | 1100 | 10.0 | 15.0 | 20.0 | 8 |
| RN 212-0.5-02-15M | 0.5 | 40 | 15.0 | 700 | 10.0 | 15.0 | 20.0 | 8 |
| RN 212-0.6-02-15M | 0.6 | 40 | 15.0 | 490 | 10.0 | 15.0 | 20.0 | 8 |
| RN 212-0.8-02-10M | 0.8 | 40 | 10.0 | 380 | 10.0 | 15.0 | 20.0 | 8 |
| RN 212-1.2-02-6M8 | 1.2 | 40 | 6.8 | 250 | 10.0 | 15.0 | 20.0 | 8 |
| RN 212-1.5-02-3M3 | 1.5 | 40 | 3.3 | 102 | 10.0 | 15.0 | 20.0 | 8 |
| RN 212-2-02-1M8 | 2.0 | 40 | 1.8 | 74 | 10.0 | 15.0 | 20.0 | 8 |
| RN 212-2-02-1M0 | 2.0 | 40 | 1.0 | 70 | 10.0 | 15.0 | 20.0 | 8 |
| RN 212-2.6-02-0M4 | 2.6 | 40 | 0.4 | 40 | 10.0 | 15.0 | 20.0 | 8 |
| RN 212-3.6-02-0M4 | 3.6 | 40 | 0.4 | 27 | 10.0 | 15.0 | 20.0 | 8 |
| RN 212-4-02-0M7 | 4.0 | 40 | 0.7 | 24 | 10.0 | 15.0 | 20.0 | 8 |
| RN 214-0.3-02-47M | 0.3 | 40 | 47.0 | 1700 | 12.5 | 10.0 | 25.0 | 14 |
| RN 214-0.5-02-56M | 0.5 | 40 | 56.0 | 1700 | 12.5 | 10.0 | 25.0 | 15 |
| RN 214-0.5-02-39M | 0.5 | 40 | 39.0 | 830 | 12.5 | 10.0 | 25.0 | 14 |
| RN 214-0.8-02-27M | 0.8 | 40 | 27.0 | 500 | 12.5 | 10.0 | 25.0 | 15 |
| RN 214-1-02-15M | 1.0 | 40 | 15.0 | 370 | 12.5 | 10.0 | 25.0 | 14 |
| RN 214-1.2-02-10M | 1.2 | 40 | 10.0 | 195 | 12.5 | 10.0 | 25.0 | 15 |
| RN 214-1.5-02-6M8 | 1.5 | 40 | 6.8 | 123 | 12.5 | 10.0 | 25.0 | 15 |
| RN 214-2-02-4M2 | 2.0 | 40 | 4.2 | 100 | 12.5 | 10.0 | 25.0 | 14 |

| Choke | Current | @ ambient | Inductance | Resistance | A | B | H | Weight |
|--------------------|---------|-------------|------------|------------|------|------|------|--------|
| | (In) | temperature | (LN) | (Rdc) | | | | |
| | [A] | [°C] | [mH] | [mOhm] | [mm] | [mm] | [mm] | (g) |
| RN 214-2-02-2M2 | 2.0 | 40 | 2.2 | 67 | 12.5 | 10.0 | 25.0 | 14 |
| RN 214-2.5-02-3M3 | 2.5 | 40 | 3.3 | 72 | 12.5 | 10.0 | 25.0 | 15 |
| RN 214-3-02-2M0 | 3.0 | 40 | 2.0 | 52 | 12.5 | 10.0 | 25.0 | 14 |
| RN 214-4-02-1M5 | 4.0 | 40 | 1.5 | 34 | 12.5 | 10.0 | 25.0 | 15 |
| RN 216-0.5-02-47M | 0.5 | 60 | 47.0 | 960 | 12.5 | 10.0 | 25.0 | 15 |
| RN 216-0.5-02-39M | 0.5 | 60 | 39.0 | 920 | 12.5 | 10.0 | 25.0 | 15 |
| RN 216-0.5-02-27M | 0.5 | 60 | 27.0 | 790 | 12.5 | 10.0 | 25.0 | 15 |
| RN 216-0.8-02-27M | 0.8 | 60 | 27.0 | 370 | 12.5 | 10.0 | 25.0 | 16 |
| RN 216-1-02-15M | 1.0 | 60 | 15.0 | 260 | 12.5 | 10.0 | 25.0 | 16 |
| RN 216-1-02-10M | 1.0 | 60 | 10.0 | 210 | 12.5 | 10.0 | 25.0 | 15 |
| RN 216-1.3-02-6M8 | 1.3 | 60 | 6.8 | 140 | 12.5 | 10.0 | 25.0 | 16 |
| RN 216-1.5-02-10M | 1.5 | 60 | 10.0 | 148 | 12.5 | 10.0 | 25.0 | 16 |
| RN 216-1.7-02-4M0 | 1.7 | 60 | 4.0 | 87 | 12.5 | 10.0 | 25.0 | 16 |
| RN 216-2-02-3M3 | 2.0 | 60 | 3.3 | 70 | 12.5 | 10.0 | 25.0 | 16 |
| RN 216-2-02-2M2 | 2.0 | 60 | 2.2 | 66 | 12.5 | 10.0 | 25.0 | 15 |
| RN 218-0.4-02-100M | 0.4 | 40 | 100 | 2800 | 10.0 | 12.5 | 20.0 | 8 |
| RN 218-0.6-02-47M | 0.6 | 40 | 47.0 | 1200 | 10.0 | 12.5 | 20.0 | 8 |
| RN 218-0.7-02-39M | 0.7 | 40 | 39.0 | 1150 | 10.0 | 12.5 | 20.0 | 8 |
| RN 218-0.9-02-27M | 0.9 | 40 | 27.0 | 620 | 10.0 | 12.5 | 20.0 | 8 |
| RN 218-1-02-22M | 1.0 | 40 | 22.0 | 520 | 10.0 | 12.5 | 20.0 | 8 |
| RN 218-1.1-02-15M | 1.1 | 40 | 15.0 | 420 | 10.0 | 12.5 | 20.0 | 8 |
| RN 218-1.4-02-10M | 1.4 | 40 | 10.0 | 330 | 10.0 | 12.5 | 20.0 | 8 |
| RN 218-1.7-02-6M8 | 1.7 | 40 | 6.8 | 180 | 10.0 | 12.5 | 20.0 | 8 |
| RN 218-2.2-02-3M3 | 2.2 | 40 | 3.3 | 100 | 10.0 | 12.5 | 20.0 | 8 |
| RN 222-0.5-02-56M | 0.5 | 40 | 56.0 | 1800 | 15.0 | 12.5 | 29.3 | 27 |
| RN 222-0.6-02-47M | 0.6 | 40 | 47.0 | 1300 | 15.0 | 12.5 | 29.3 | 26 |
| RN 222-0.8-02-39M | 0.8 | 40 | 39.0 | 1000 | 15.0 | 12.5 | 29.3 | 27 |
| RN 222-1-02-33M | 1.0 | 40 | 33.0 | 1300 | 15.0 | 12.5 | 29.3 | 29 |
| RN 222-1-02-18M | 1.0 | 40 | 18.0 | 630 | 15.0 | 12.5 | 29.3 | 26 |
| RN 222-1.5-02-10M | 1.5 | 40 | 10.0 | 250 | 15.0 | 12.5 | 29.3 | 26 |
| RN 222-2-02-6M8 | 2.0 | 40 | 6.8 | 156 | 15.0 | 12.5 | 29.3 | 28 |
| RN 222-2.5-02-5M6 | 2.5 | 40 | 5.6 | 110 | 15.0 | 12.5 | 29.3 | 27 |
| RN 222-3-02-4M5 | 3.0 | 40 | 4.5 | 80 | 15.0 | 12.5 | 29.3 | 28 |
| RN 222-4-02-3M3 | 4.0 | 40 | 3.3 | 46 | 15.0 | 12.5 | 29.3 | 28 |
| RN 232-0.6-02-47M | 0.6 | 40 | 47.0 | 1300 | 15.0 | 12.5 | 34.3 | 37 |
| RN 232-1-02-18M | 1.0 | 40 | 18.0 | 390 | 15.0 | 12.5 | 34.3 | 38 |
| RN 232-1.6-02-10M | 1.6 | 40 | 10.0 | 170 | 15.0 | 12.5 | 34.3 | 38 |
| RN 232-2.5-02-5M6 | 2.5 | 40 | 5.6 | 86 | 15.0 | 12.5 | 34.3 | 38 |
| RN 232-4-02-3M3 | 4.0 | 40 | 3.3 | 54 | 15.0 | 12.5 | 34.3 | 38 |
| RN 242-0.5-02-82M | 0.5 | 40 | 82.0 | 2700 | 15.0 | 12.5 | 34.3 | 37 |
| RN 242-1-02-33M | 1.0 | 40 | 33.0 | 810 | 15.0 | 12.5 | 34.3 | 38 |
| RN 242-1.4-02-27M | 1.4 | 40 | 27.0 | 500 | 15.0 | 12.5 | 34.3 | 38 |
| RN 242-2-02-6M8 | 2.0 | 40 | 6.8 | 192 | 15.0 | 12.5 | 34.3 | 37 |
| RN 242-4-02-3M3 | 4.0 | 40 | 3.3 | 67 | 15.0 | 12.5 | 34.3 | 38 |
| RN 242-6-02-1M8 | 6.0 | 40 | 1.8 | 20 | 15.0 | 12.5 | 34.3 | 41 |

Test conditions: Measuring frequency: 10 kHz; 50 mV; Inductance tolerance: +50%, -30%; Resistance tolerance: ±15% @ 25°C; Electrical characteristics @ 25°C: ±2°C;
 Stray Inductance measurement between pin 1 and 2 (pin 3 and 4 shorted)
 For mechanical tolerances refer to mechanical data section.

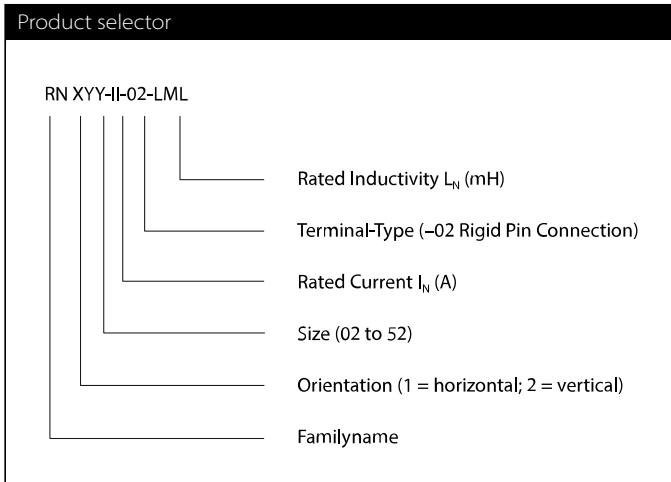

Thermal Derating

If higher ambient temperatures than the specified apply, the nominal current needs to be reduced according to the graph below.

Graph on the left side applies to RN with rated ambient temperature of 40 °C, right side for rated ambient temperature of 60 °C.

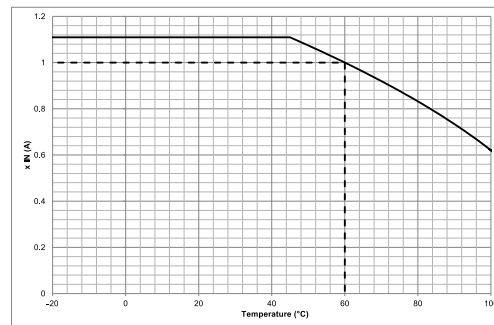
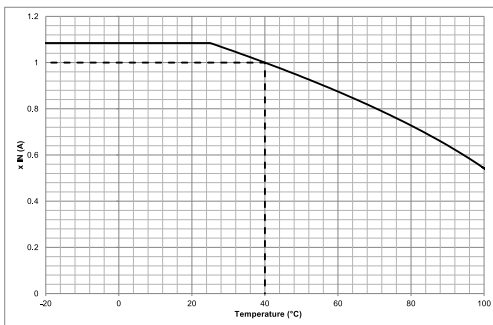

Typical attenuation/resonance frequency characteristics

Per CISPR 17; 50 Ω/50 Ω asym

X can be exchanged with either 1 or 2 for different housing configuration, attenuation is similar



RN 218



RN 122, RN 222



RN 232



RN 142, RN 242



RN 143



RN 152



Mechanical data

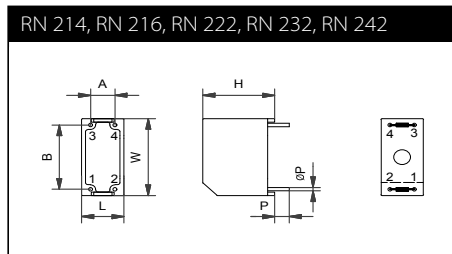
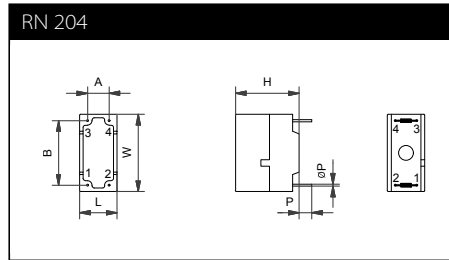
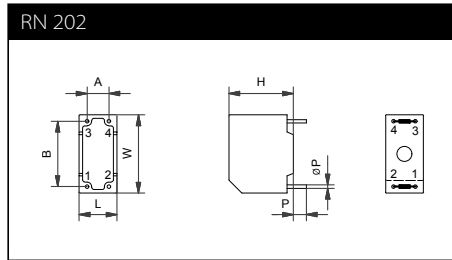
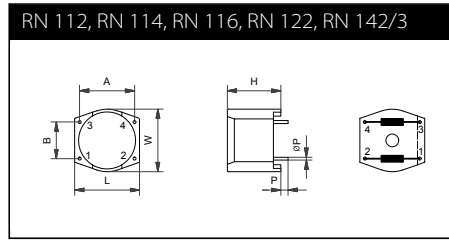
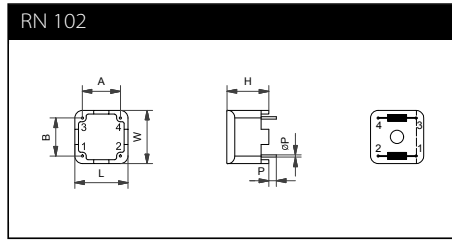

Pin material: Steel (base), Cu (under plating), Sn (final plating 6µm)

Dimensions

| | A (±0.6 mm) | B (±0.6 mm) | H (±0.3 mm) | L (±0.3 mm) | W (±0.3 mm) | P (±0.5 mm) | ØP (±0.1 mm) |
|---------------|-----------------------|-----------------------|-----------------------|-----------------------|-----------------------|-----------------------|------------------------|
| RN 102 | 10.0 mm | 10.0 mm | 9.0 mm | 14.0 mm | 14.0 mm | 4.0 mm | 0.6 mm |
| RN 112 | 15.0 mm | 10.0 mm | 12.6 mm | 17.7 mm | 17.1 mm | 4.0 mm | 0.8 mm |
| RN 114 | 20.1 mm | 12.5 mm | 13.2 mm | 22.5 mm | 21.5 mm | 4.0 mm | 0.8 mm |
| RN 116 | 20.1 mm | 12.5 mm | 13.2 mm | 22.5 mm | 21.5 mm | 4.0 mm | 0.8 mm |
| RN 122 | 25.0 mm | 15.0 mm | 16.5 mm | 28.0 mm | 27.0 mm | 4.0 mm | 0.8 mm |
| RN 142 | 30.0 mm | 20.0 mm | 19.7 mm | 33.1 mm | 32.5 mm | 4.3 mm | 0.8 mm |
| RN 143 | 30.0 mm | 20.0 mm | 19.7 mm | 33.1 mm | 32.5 mm | 4.3 mm | 0.8 mm |
| RN 152 | 40.0 mm | 15.0 mm | 25.0 mm | 43.0 mm | 41.8 mm | 4.5 mm | 1.2 mm |
| RN 202 | 5.1 mm | 15.2 mm | 13.5 mm | 8.8 mm | 18.2 mm | 4.5 mm | 0.8 mm |
| RN 204 | 7.6 mm | 10.0 mm | 14.3 mm | 9.0 mm | 14.0 mm | 4.0 mm | 0.5 mm |
| RN 212 | 10.0 mm | 15.0 mm | 20.0 mm | 12.5 mm | 18.0 mm | 4.0 mm | 0.8 mm |
| RN 214 | 12.5 mm | 10.0 mm | 25.0 mm | 15.5 mm | 23.0 mm | 4.0 mm | 0.8 mm |
| RN 216 | 12.5 mm | 10.0 mm | 25.0 mm | 15.5 mm | 23.0 mm | 4.0 mm | 0.8 mm |
| RN 218 | 10.0 mm | 12.5 mm | 20.0 mm | 12.5 mm | 18.0 mm | 4.0 mm | 0.8 mm |
| RN 222 | 15.0 mm | 12.5 mm | 29.3 mm | 18.0 mm | 31.0 mm | 4.0 mm | 0.8 mm |
| RN 232 | 15.0 mm | 12.5 mm | 34.3 mm | 18.0 mm | 31.0 mm | 4.2 mm | 0.8 mm |
| RN 242 | 15.0 mm | 12.5 mm | 34.3 mm | 18.0 mm | 31.0 mm | 4.2 mm | 0.8 mm |

Please visit www.schaffner.com to find more details on filter connections.



Headquarters, global innovation and development

Switzerland

Schaffner Group

Industrie Nord
Nordstrasse 11e
4542 Luterbach
T +41 32 681 66 26
info@schaffner.com



Sales and application centers

China

Schaffner EMC Ltd. Shanghai

T20-3 C, No 565 Chuangye Road,
Pudong district
201201 Shanghai
T +86 21 3813 9500
cschina@schaffner.com
www.schaffner.com.cn

Finland

Schaffner Oy

Sauvonrinne 19 H
08500 Lohja
T +358 10 567 2855
finlandsales@schaffner.com

France

Schaffner EMC S.A.S.

16-20 Rue Louis Rameau
95875 Bezons
T +33 1 34 34 30 60
F +33 1 39 47 02 28
francesales@schaffner.com

Germany

Schaffner Deutschland GmbH

Schoemperlenstrasse 12B
76185 Karlsruhe
T +49 721 56910
F +49 721 569110
germanysales@schaffner.com

India

Schaffner India Pvt. Ltd

REGUS WORLD TRADE CENTRE
WTC, 22nd Floor Unit No 2238, Brigade
Gateway Campus, 26/1, Dr. Rajkumar Road
Malleshwaram (W)
560055 Bangalore
T +91 80 67935355
indiasales@schaffner.com

Italy

Schaffner EMC S.r.l.

Via Ticino, 30
20900 Monza (MB)
T +39 039 21 41 070
italysales@schaffner.com

Japan

Schaffner EMC K.K.

Taiju-Seimei Sangenjaya Bldg.
1-32-12, Kamiuma, Setagaya-ku
154-0011 Tokyo
T +81 3 5712 3650
F +81 3 5712 3651
japansales@schaffner.com
www.schaffner.jp

Singapore

Schaffner EMC Pte Ltd.

#05-09, Kg Ubi Ind. Estate
408705 Singapore
T +65 6377 3283
F +65 6377 3281
singaporesales@schaffner.com

Spain

Schaffner EMC España

Calle Caléndula 93, Miniparc III, Edificio E
El Soto de Moraleja, Alcobendas
28109 Madrid
T +34 917 912 900
F +34 917 912 901
spainsales@schaffner.com

Sweden

Schaffner EMC AB

Östermalmstorg 1
114 42 Stockholm
T +46 8 5050 2425
swedensales@schaffner.com
www.schaffner.com

Switzerland

Schaffner EMV AG

Industrie Nord
Nordstrasse 11e
4542 Luterbach
T +41 32 681 66 26
switzerlandsales@schaffner.com

Taiwan R.O.C.

Schaffner EMV Ltd.

20 Floor-2, No 97, Section 1, XinTai 5th Road
22175 XiZhi District New Taipei City 22175
T +886 2 2697 5500
F +886 2 2697 5533
taiwansales@schaffner.com
www.schaffner.com.tw

Thailand

Schaffner EMC Co. Ltd.

Northern Region Industrial Estate
67 Moo 4 Tambon Ban Klang
Amphur Muangng P.O. Box 14
51000 Lamphun
T +66 53 58 11 04
F +66 53 58 10 19
thailandsales@schaffner.com

United Kingdom

Schaffner Ltd.

1, Oakmede Place
Binfield
RG42 4JF Berkshire
T +44 118 9770070
F +44 118 9792969
uksales@schaffner.com

USA

Schaffner EMC Inc.

52 Mayfield Avenue
Edison, New Jersey
T +1 732 225 9533
F +1 732 225 4789
usasales@schaffner.com
www.schaffnerusa.com

Schaffner North America

6722 Thirlane Road
24019 Roanoke, Virginia
T +1 276 228 7943
F +1 276 228 7953

Schaffner North America

823 Fairview Road
24382 Wytheville, Virginia
T +1 276 228 7943
F +1 276 228 7258

To find your local partner within Schaffner's global network: www.schaffner.com

© 2018 Schaffner Group

The content of this document has been carefully checked and understood. However, neither Schaffner nor its subsidiaries assume any liability whatsoever for any errors or inaccuracies of this document and the consequences thereof. Published specifications are subject to change without notice. Product suitability for any area of application must ultimately be determined by the customer. In all cases, products must never be operated outside their published specifications. Schaffner does not guarantee the availability of all published products. This disclaimer shall be governed by substantive Swiss law and resulting disputes shall be settled by the courts at the place of business of Schaffner Holding AG. Latest publications and a complete disclaimer can be downloaded from the Schaffner website. All trademarks recognized.



Компания «ЭлектроПласт» предлагает заключение долгосрочных отношений при поставках импортных электронных компонентов на взаимовыгодных условиях!

Наши преимущества:

- Оперативные поставки широкого спектра электронных компонентов отечественного и импортного производства напрямую от производителей и с крупнейших мировых складов;
- Поставка более 17-ти миллионов наименований электронных компонентов;
- Поставка сложных, дефицитных, либо снятых с производства позиций;
- Оперативные сроки поставки под заказ (от 5 рабочих дней);
- Экспресс доставка в любую точку России;
- Техническая поддержка проекта, помощь в подборе аналогов, поставка прототипов;
- Система менеджмента качества сертифицирована по Международному стандарту ISO 9001;
- Лицензия ФСБ на осуществление работ с использованием сведений, составляющих государственную тайну;
- Поставка специализированных компонентов (Xilinx, Altera, Analog Devices, Intersil, Interpoint, Microsemi, Aeroflex, Peregrine, Syfer, Eurofarad, Texas Instrument, Miteq, Cobham, E2V, MA-COM, Hittite, Mini-Circuits, General Dynamics и др.);

Помимо этого, одним из направлений компании «ЭлектроПласт» является направление «Источники питания». Мы предлагаем Вам помощь Конструкторского отдела:

- Подбор оптимального решения, техническое обоснование при выборе компонента;
- Подбор аналогов;
- Консультации по применению компонента;
- Поставка образцов и прототипов;
- Техническая поддержка проекта;
- Защита от снятия компонента с производства.



Как с нами связаться

Телефон: 8 (812) 309 58 32 (многоканальный)

Факс: 8 (812) 320-02-42

Электронная почта: org@eplast1.ru

Адрес: 198099, г. Санкт-Петербург, ул. Калинина, дом 2, корпус 4, литера А.