

Agency Approvals

| AGENCY | AGENCY FILE NUMBER |
|---|--------------------|
|  | E128662/E230531 |

Maximum Ratings and Thermal Characteristics (T_A=25°C unless otherwise noted)

| Parameter | Symbol | Value | Unit |
|---|-----------------------------------|------------|------|
| Peak Pulse Power Dissipation by 10x1000µs test waveform (Fig.1) (Note 1) | P _{PPM} | 15000 | W |
| Steady State Power Dissipation on infinite heat sink at T _L =75°C (Fig. 5) | P _D | 8.0 | W |
| Peak Forward Surge Current, 8.3ms Single Half Sine Wave Unidirectional only (Note 2) | I _{FSM} | 400 | A |
| Operating Junction and Storage Temperature Range | T _J , T _{STG} | -55 to 175 | °C |
| Typical Thermal Resistance Junction to Lead | R _{θJL} | 8.0 | °C/W |
| Typical Thermal Resistance Junction to Ambient | R _{θJA} | 40 | °C/W |

Notes:

1. Non-repetitive current pulse, per Fig. 3 and derated above T_A = 25°C per Fig. 2.
2. Measured on 8.3ms single half sine wave or equivalent square wave, duty cycle=4 per minute maximum.

Description

The 15KPA Series is designed specifically to protect sensitive electronic equipment from voltage transients induced by lightning and other transient voltage events.

Features

- Halogen-Free
- RoHS compliant
- Typical maximum temperature coefficient
 $\Delta V_{BR} = 0.1\% \times V_{BR} @ 25^\circ\text{C} \times \Delta T$
- Glass passivated chip junction in P600 package
- 15000W peak pulse capability at 10x1000µs waveform, repetition rate (duty cycles):0.01%
- Fast response time: typically less than 1.0ps from 0 Volts to BV min
- Excellent clamping capability
- Low incremental surge resistance
- Typical I_R less than 2µA above 36V
- High temperature soldering guaranteed: 260°C/40 seconds / 0.375" (9.5mm) lead length, 5 lbs., (2.3kg) tension
- Plastic package has Underwriters Laboratory Flammability classification 94V-O
- Matte Tin Lead-free plated

Applications

TVS devices are ideal for the protection of I/O interfaces, V_{CC} bus and other vulnerable circuits used in telecom, computer, industrial and consumer electronic applications.

Transient Voltage Suppression Diodes

Axial Leaded – 15000W > 15KPA series

Electrical Characteristics

| Part Number (Uni) | Part Number (Bi) | Reverse Stand off Voltage V_R (Volts) | Breakdown Voltage V_{BR} (Volts) @ I_T | Test Current I_T (mA) | Maximum Peak Pulse Current I_{PP} (A) | Maximum Reverse Leakage I_R @ V_R (μ A) | Maximum Clamping Voltage V_C @ I_{PP} (V) | Agency Approval  |
|-------------------|------------------|---|--|-------------------------|---|--|---|---|
| | | | MIN | | | | | |
| 15KPA17A | 15KPA17CA | 17 | 18.99 | 50 | 515.4 | 5000 | 29.3 | X |
| 15KPA18A | 15KPA18CA | 18 | 20.11 | 50 | 488.7 | 5000 | 30.9 | X |
| 15KPA20A | 15KPA20CA | 20 | 22.34 | 20 | 440.2 | 1500 | 34.3 | X |
| 15KPA22A | 15KPA22CA | 22 | 24.57 | 10 | 407.0 | 500 | 37.1 | X |
| 15KPA24A | 15KPA24CA | 24 | 26.81 | 5 | 371.0 | 150 | 40.7 | X |
| 15KPA26A | 15KPA26CA | 26 | 29.04 | 5 | 343.2 | 50 | 44.0 | X |
| 15KPA28A | 15KPA28CA | 28 | 31.28 | 5 | 317.9 | 25 | 47.5 | X |
| 15KPA30A | 15KPA30CA | 30 | 33.51 | 5 | 297.8 | 15 | 50.7 | X |
| 15KPA33A | 15KPA33CA | 33 | 36.90 | 5 | 276.1 | 2 | 54.7 | X |
| 15KPA36A | 15KPA36CA | 36 | 40.20 | 5 | 252.5 | 2 | 59.8 | X |
| 15KPA40A | 15KPA40CA | 40 | 44.70 | 5 | 229.5 | 2 | 65.8 | X |
| 15KPA43A | 15KPA43CA | 43 | 48.00 | 5 | 216.3 | 2 | 69.8 | X |
| 15KPA45A | 15KPA45CA | 45 | 50.30 | 5 | 207.4 | 2 | 72.8 | X |
| 15KPA48A | 15KPA48CA | 48 | 53.60 | 5 | 194.3 | 2 | 77.7 | X |
| 15KPA51A | 15KPA51CA | 51 | 57.00 | 5 | 182.1 | 2 | 82.9 | X |
| 15KPA54A | 15KPA54CA | 54 | 60.30 | 5 | 172.2 | 2 | 87.7 | X |
| 15KPA58A | 15KPA58CA | 58 | 64.80 | 5 | 161.0 | 2 | 93.8 | X |
| 15KPA60A | 15KPA60CA | 60 | 67.00 | 5 | 155.0 | 2 | 97.4 | X |
| 15KPA64A | 15KPA64CA | 64 | 71.50 | 5 | 144.9 | 2 | 104.2 | X |
| 15KPA70A | 15KPA70CA | 70 | 78.20 | 5 | 132.9 | 2 | 113.6 | X |
| 15KPA75A | 15KPA75CA | 75 | 83.80 | 5 | 123.8 | 2 | 122.0 | X |
| 15KPA78A | 15KPA78CA | 78 | 87.10 | 5 | 119.7 | 2 | 126.1 | X |
| 15KPA85A | 15KPA85CA | 85 | 94.90 | 5 | 109.7 | 2 | 137.6 | X |
| 15KPA90A | 15KPA90CA | 90 | 100.50 | 5 | 103.7 | 2 | 145.6 | X |
| 15KPA100A | 15KPA100CA | 100 | 111.70 | 5 | 93.6 | 2 | 161.3 | X |
| 15KPA110A | 15KPA110CA | 110 | 122.90 | 5 | 84.5 | 2 | 178.6 | X |
| 15KPA120A | 15KPA120CA | 120 | 134.00 | 5 | 78.5 | 2 | 192.3 | X |
| 15KPA130A | 15KPA130CA | 130 | 145.20 | 5 | 72.5 | 2 | 208.3 | X |
| 15KPA150A | 15KPA150CA | 150 | 167.60 | 5 | 62.4 | 2 | 241.9 | X |
| 15KPA160A | 15KPA160CA | 160 | 178.70 | 5 | 58.4 | 2 | 258.6 | X |
| 15KPA170A | 15KPA170CA | 170 | 189.90 | 5 | 55.4 | 2 | 272.7 | X |
| 15KPA180A | 15KPA180CA | 180 | 201.10 | 5 | 52.3 | 2 | 288.5 | X |
| 15KPA200A | 15KPA200CA | 200 | 223.40 | 5 | 47.3 | 2 | 319.1 | X |
| 15KPA220A | 15KPA220CA | 220 | 245.70 | 5 | 35.2 | 2 | 428.6 | X |
| 15KPA240A | 15KPA240CA | 240 | 268.10 | 5 | 39.3 | 2 | 384.6 | X |
| 15KPA260A | 15KPA260CA | 260 | 290.40 | 5 | 36.2 | 2 | 416.7 | X |
| 15KPA280A | 15KPA280CA | 280 | 312.80 | 5 | 33.2 | 2 | 454.5 | X |

For bidirectional type having V_R of 30 volts and less, the I_R limit is double.

For parts without A, the V_{BR} is $\pm 10\%$ and V_C is 5% higher than with A parts

Ratings and Characteristic Curves ($T_A=25^\circ\text{C}$ unless otherwise noted)

Figure 1 - Peak Pulse Power Rating Curve

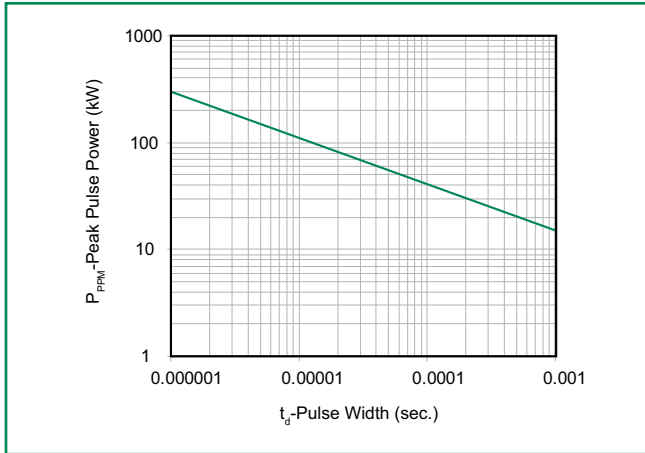

Figure 2 - Pulse Derating Curve

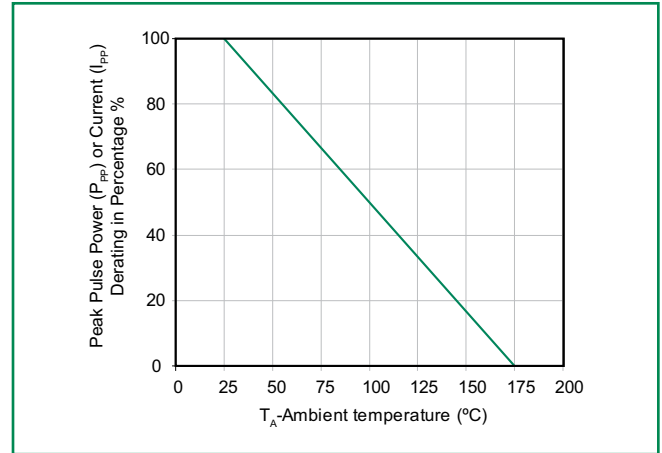

Figure 3 - Test Pulse Waveform

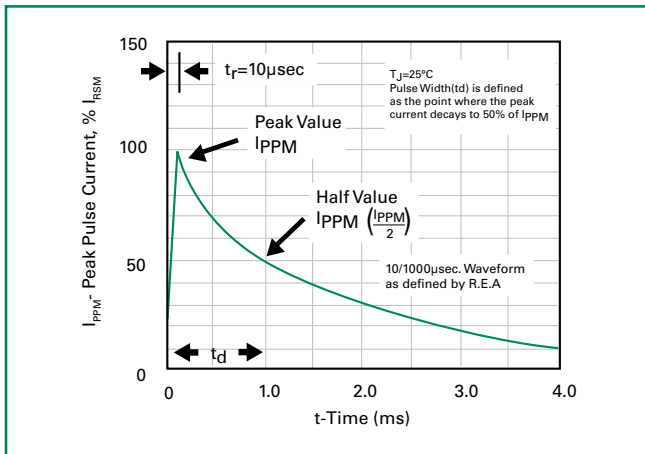

Figure 4 - Typical Junction Capacitance

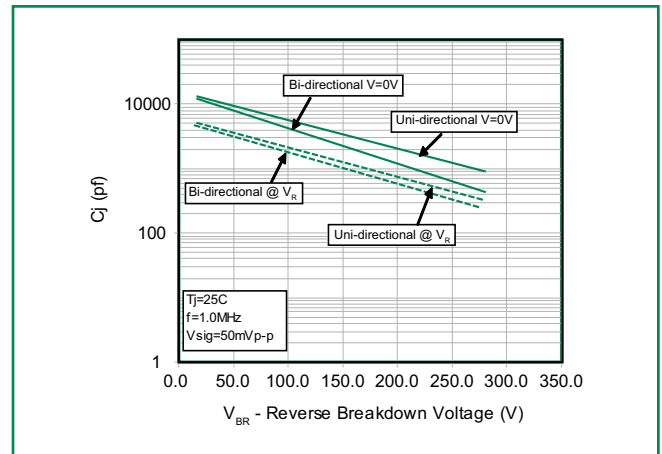

Figure 5 - Steady State Power Derating Curve

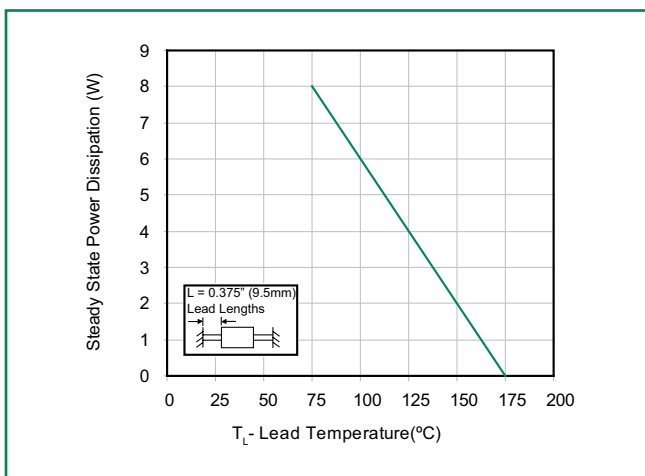
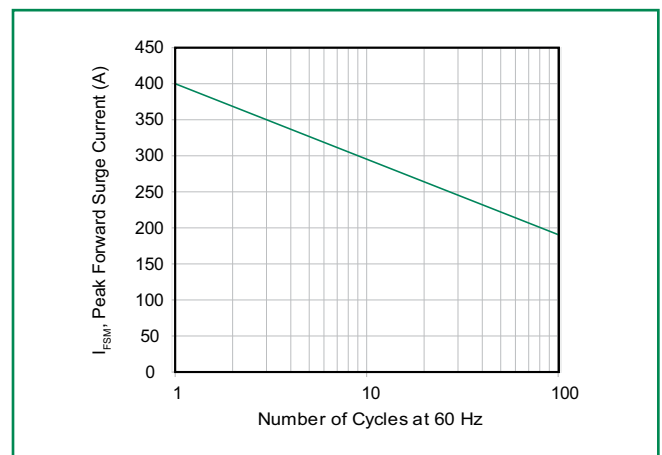

Figure 6 - Maximum Non-Repetitive Forward Surge Current



15KPA Series

Soldering Parameters

| | | |
|--|------------------------------------|-------------------------|
| Reflow Condition | | Lead-free assembly |
| Pre Heat | - Temperature Min ($T_{s(min)}$) | 150°C |
| | - Temperature Max ($T_{s(max)}$) | 200°C |
| | - Time (min to max) (t_s) | 60 – 180 secs |
| Average ramp up rate (Liquidus Temp (T_L) to peak) | | 3°C/second max |
| $T_{s(max)}$ to T_L - Ramp-up Rate | | 3°C/second max |
| Reflow | - Temperature (T_L) (Liquidus) | 217°C |
| | - Time (min to max) (t_s) | 60 – 150 seconds |
| Peak Temperature (T_p) | | 260 ^{+0/-5} °C |
| Time within 5°C of actual peak Temperature (t_p) | | 20 – 40 seconds |
| Ramp-down Rate | | 6°C/second max |
| Time 25°C to peak Temperature (T_p) | | 8 minutes Max. |
| Do not exceed | | 280°C |

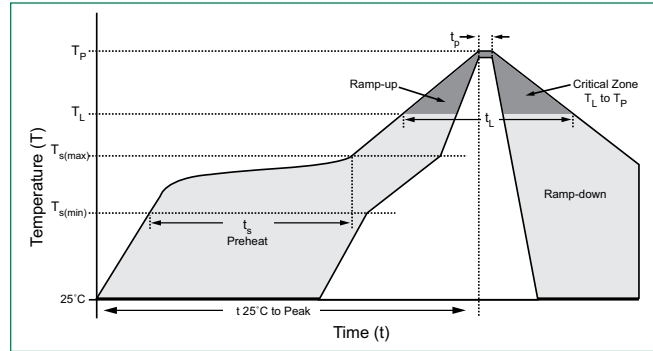

Flow/Wave Soldering (Solder Dipping)

| | |
|---------------------------|------------|
| Peak Temperature : | 265°C |
| Dipping Time : | 10 seconds |
| Soldering : | 1 time |

Physical Specifications

| | |
|-----------------|---|
| Weight | 0.07oz., 2.5g |
| Case | P600 molded plastic body over passivated junction. |
| Polarity | Color band denotes the cathode except Bipolar. |
| Terminal | Matte Tin axial leads, solderable per JESD22-B102D. |

Environmental Specifications

| | |
|---------------------------|--------------|
| Temperature Cycle | JESD22-A104 |
| Pressure Cooker | JESD 22-A102 |
| High Temp. Storage | JESD22-A103 |
| HTRB | JESD22-A108 |
| Thermal Shock | JESD22-A106 |

Dimensions

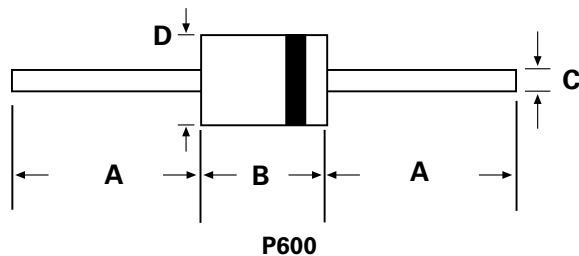

| Dimensions | Inches | | Millimeters | |
|------------|--------|-------|-------------|------|
| | Min | Max | Min | Max |
| A | 1.000 | - | 25.40 | - |
| B | 0.340 | 0.360 | 8.60 | 9.10 |
| C | 0.048 | 0.052 | 1.22 | 1.32 |
| D | 0.340 | 0.360 | 8.60 | 9.10 |

Part Numbering System

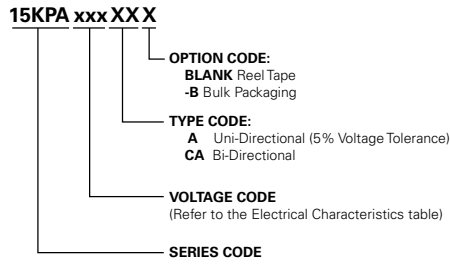

Part Marking System

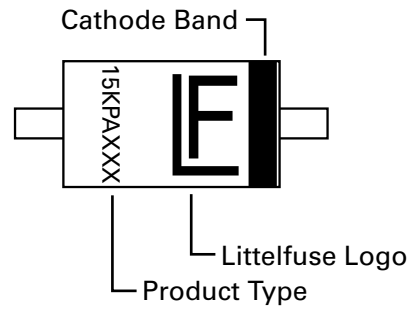

Packaging

| Part Number | Component Package | Quantity | Packaging Option | Packaging Specification |
|--------------|-------------------|----------|------------------|--|
| 15KPAxxxXX | P600 | 800 | Tape & Reel | EIA STD RS-296E |
| 15KPAxxxXX-B | P600 | 500 | BULK | Littelfuse Concord Packing Spec. DM-0016 |



Компания «ЭлектроПласт» предлагает заключение долгосрочных отношений при поставках импортных электронных компонентов на взаимовыгодных условиях!

Наши преимущества:

- Оперативные поставки широкого спектра электронных компонентов отечественного и импортного производства напрямую от производителей и с крупнейших мировых складов;
- Поставка более 17-ти миллионов наименований электронных компонентов;
- Поставка сложных, дефицитных, либо снятых с производства позиций;
- Оперативные сроки поставки под заказ (от 5 рабочих дней);
- Экспресс доставка в любую точку России;
- Техническая поддержка проекта, помощь в подборе аналогов, поставка прототипов;
- Система менеджмента качества сертифицирована по Международному стандарту ISO 9001;
- Лицензия ФСБ на осуществление работ с использованием сведений, составляющих государственную тайну;
- Поставка специализированных компонентов (Xilinx, Altera, Analog Devices, Intersil, Interpoint, Microsemi, Aeroflex, Peregrine, Syfer, Eurofarad, Texas Instrument, Miteq, Cobham, E2V, MA-COM, Hittite, Mini-Circuits, General Dynamics и др.);

Помимо этого, одним из направлений компании «ЭлектроПласт» является направление «Источники питания». Мы предлагаем Вам помощь Конструкторского отдела:

- Подбор оптимального решения, техническое обоснование при выборе компонента;
- Подбор аналогов;
- Консультации по применению компонента;
- Поставка образцов и прототипов;
- Техническая поддержка проекта;
- Защита от снятия компонента с производства.



Как с нами связаться

Телефон: 8 (812) 309 58 32 (многоканальный)

Факс: 8 (812) 320-02-42

Электронная почта: org@eplast1.ru

Адрес: 198099, г. Санкт-Петербург, ул. Калинина, дом 2, корпус 4, литера А.