

Features

- Maximum rated frequency: 133 MHz
- Low cycle-to-cycle jitter
- Input to output delay, less than 300ps
- Internal feedback allows outputs to be synchronized to the clock input
- 5V tolerant input*
- Spread spectrum clock ready
- Operates at 3.3V V_{DD}
- Packaging (Pb-free & Green available):
 - 8-pin, 150-mil SOIC (W)
 - 8-pin, 173-mil TSSOP (L)

* CLKIN must reference the same voltage thresholds for the PLL to deliver zero delay skewing

Description

The PI6C2405A is a PLL based, zero-delay buffer, with the ability to distribute five outputs of up to 133MHz at 3.3V. All the outputs are distributed from a single clock input CLKIN and output OUT0 performs zero delay by connecting a feedback to PLL.

An internal feedback on OUT0 is used to synchronize the outputs to the input; the relationship between loading of this signal and the outputs determines the input-output delay. PI6C2405A is able to track spread spectrum clocking for EMI reduction. PI6C2405A is characterized for both commercial and industrial operation.

PI6C2405A-1H is a high-drive version of PI6C2405A-1

Block Diagram

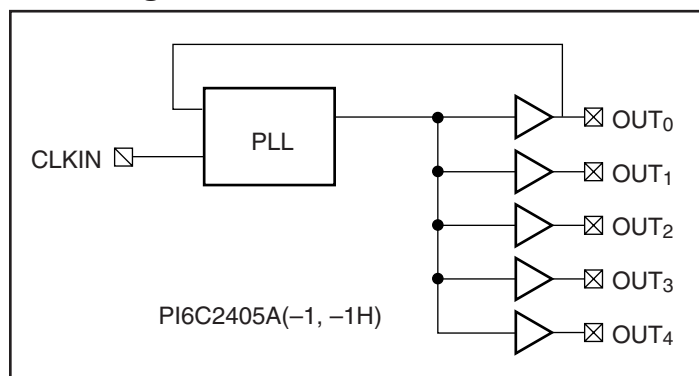

Pin Configuration

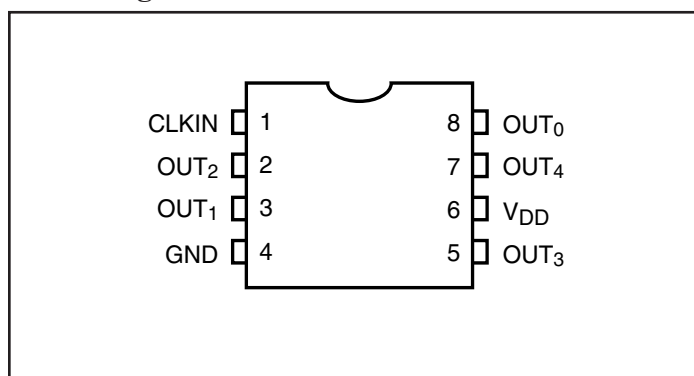

Pin Description

Pin	Signal	Description
1	CLKIN	Input clock reference frequency (weak pull-down)
2, 3, 5, 7	OUT[1-4]	Clock Outputs
4	GND	Ground
6	V _{DD}	3.3V Supply
8	OUT0	Clockoutput, internal PLL feedback (weak pull-down)

Zero Delay and Skew Control

CLKIN Input to OUTx Delay vs. Difference in Loading between OUT0 pin and OUTx pins

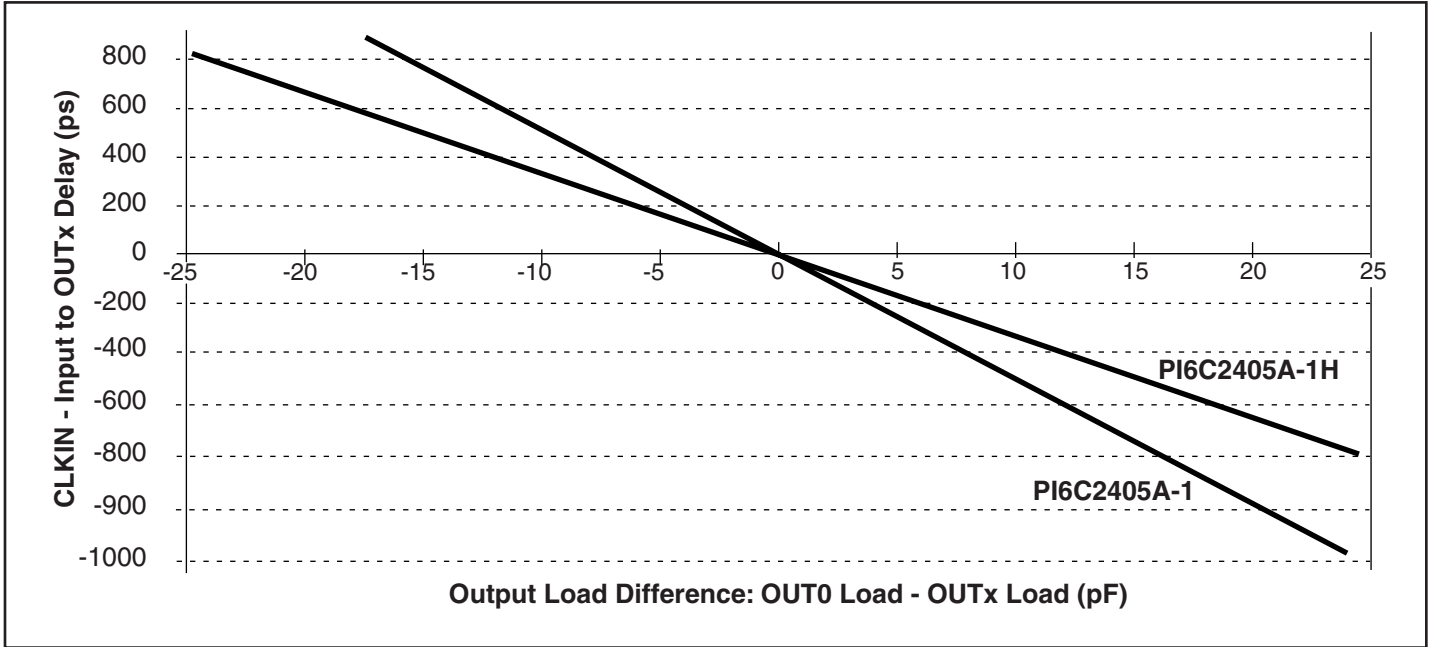

The relationship between loading of the OUT0 signal and other outputs determines the input-output delay. Zero delay is achieved when all outputs, including feedback, are loaded equally.

Maximum Ratings

Supply Voltage to Ground Potential.....	-0.5V to +7.0V
DC Input Voltage (Except CLKIN).....	-0.5V to V _{DD} +0.5V
DC Input Voltage CLKIN	-0.5 to 7V
Storage Temperature	-65°C to +150°C
Maximum Soldering Temperature (10 seconds)	260°C
Junction Temperature	150°C
Static Discharge Voltage (per MIL-STD-883, Method 3015).....	>2000V

Operating Conditions (V_{CC} = 3.3V ±0.3V)

Parameter	Description	Min.	Max.	Units
V _{DD}	Supply Voltage	3.0	3.6	V
T _A	Commerical Operating Temperature	0	70	°C
	Industrial Operating Temperature	-40	85	
C _L	Load Capacitance, below 100 MHz		30	pF
	Load Capacitance, from 100 MHz to 133		15	
C _{IN}	Input Capacitance		7	

DC Electrical Characteristics for Industrial Temperature Devices

Parameter	Description	Test Conditions	Min.	Max.	Units
V _{IL}	Input LOW Voltage			0.8	V
V _{IH}	Input HIGH Voltage		2.0		
I _{IL}	Input LOW Current	V _{IN} = 0V		50	μA
I _{IH}	Input HIGH Current	V _{IN} = V _{DD}		125	
V _{OL}	Output LOW Voltage	I _{OL} = -8mA(-1); I _{OL} = 12mA(-1H)		0.4	V
V _{OH}	Output HIGH Voltage	I _{OH} = -8mA(-1); I _{OH} = -12mA(-1H)	2.4		
I _{DD}	Supply Current	Unloaded outputs 100 MHz, Select inputs at V _{DD} or GND		54	mA
		Unloaded outputs 66 MHz, CLKIN		39	

AC Electrical Characteristics for Industrial Temperature Devices

Parameter	Description	Test Conditions	Min.	Typ.	Max.	Units
F _O	Output Frequency	30pF load	10		100	MHz
		15pF load	10		133	
t _{DC}	Duty Cycle ⁽¹⁾ (-1)	Measured at V _{DD} /2, F _{OUT} < 66.67MHz, 30pF load	40	50	60	%
		Measured at V _{DD} /2, F _{OUT} < 45MHz 15pF load	45		55	
	Duty Cycle ⁽¹⁾ (-1H)	Measured at V _{DD} /2, F _{OUT} < 100MHz 15pF load	40		60	
		Measured at V _{DD} /2, F _{OUT} < 45MHz 30pF load	45		55	
t _R	Rise Time ⁽¹⁾ (-1)	Measured between 0.8V and 2.0V, 30pF load			2.2	ns
		Measured between 0.8V and 2.0V, 15pF load			1.5	
	Rise Time ⁽¹⁾ (-1H)	Measured between 0.8V and 2.0V, 30pF load			1.7	
		Measured between 0.8V and 2.0V, 15pF load			1.5	
t _F	Fall Time ⁽¹⁾ (-1)	Measured between 0.8V and 2.0V, 30pF load			2.2	
		Measured between 0.8V and 2.0V, 15pF load			1.5	
	Fall Time ⁽¹⁾ (-1H)	Measured between 0.8V and 2.0V, 30pF load			1.5	
t _{sk(o)}	Output to Output skew (-1, -1H) ⁽¹⁾	All outputs equally loaded			200	
t ₀	Delay, CLKIN Rising Edge to OUT0 Rising Edge ⁽¹⁾	Measured at V _{DD} /2		0	±300	ps
t _{SK(D)}	Device-to-device skew ⁽¹⁾	Measured at V _{DD} /2 on OUT0 pins of device		0	600	
t _{SLEW}	Output slew rate ⁽¹⁾	Measured between 0.8V and 2.0V on -1H device using Test Circuit #2	1			V/ns
t _{JIT}	Cycle-to-Cycle Jitter (-1, -1H)	Measured at 66.67 MHz, loaded 30pF load			200	ps
t _{LOCK}	PLL Lock time ⁽¹⁾	Stable power supply, valid clocks presented on CLKIN pin			1.0	ms

Notes:

1. See Switching Waveforms on page 5.

DC Electrical Characteristics for Commercial Temperature Devices

Parameter	Description	Test Conditions	Min.	Max.	Units
V _{IL}	Input LOW Voltage			0.8	V
V _{IH}	Input HIGH Voltage		2.0		
I _{IL}	Input LOW Current	V _{IN} = 0V		50	μA
I _{IH}	Input HIGH Current	V _{IN} = V _{DD}		125	
V _{OL}	Output LOW Voltage	I _{OL} = -8mA(-1); I _{OL} = 12mA(-1H)		0.4	V
V _{OH}	Output HIGH Voltage	I _{OH} = -8mA(-1); I _{OH} = -12mA(-1H)	2.4		
I _{DD}	Supply Current	Unloaded outputs 100 MHz, Select inputs at V _{DD} or GND		54	mA
		Unloaded outputs 66.67 MHz, select inputs at V _{DD} or GND		39	

AC Electrical Characteristics for Commercial Temperature Devices

Parameter	Description	Test Conditions	Min.	Typ.	Max.	Units
F _O	Output Frequency	30pF load	10		100	MHz
		15pF load	10		133	
t _{DC}	Duty Cycle ⁽¹⁾ (-1)	Measured at V _{DD} /2, F _O < 66 MHz, 30pF load	40	50	60	%
	Duty Cycle ⁽¹⁾ (-1H)	Measured at V _{DD} /2, F _O < 66 MHz, 30pF load	45	50	55	
t _R	Rise Time ⁽¹⁾ @ 30pF	Measured between 0.8V and 2.0V			2.2	ns
	Rise Time ⁽¹⁾ @ 15pF				1.5	
	Rise Time ⁽¹⁾ @ 30pF (-1H)				1.5	
t _F	Fall Time ⁽¹⁾ @ 30pF	Measured between 0.8V and 2.0V			2.2	
	Fall Time ⁽¹⁾ @ 15pF				1.5	
	Fall Time ⁽¹⁾ @ 30pF (-1H)				1.5	
t _{sk(o)}	Output to Output skew (-1, -1H) ⁽¹⁾	All outputs equally loaded			200	ps
t ₀	Input to output delay, CLKIN Rising Edge to OUT0 Rising Edge ⁽¹⁾	Measured at V _{DD} /2		0	±300	
t _{SK(D)}	Device-to-device skew ⁽¹⁾	Measured at V _{DD} /2 on OUT0 pins of device		0	600	
t _{SLEW}	Output slew rate ⁽¹⁾	Measured between 0.8V and 2.0V on -1H device using Test Circuit #2	1			V/ns
t _{JIT}	Cycle-to-Cycle Jitter (-1, -1H)	Measured at 66.67 MHz, loaded 30pF load			200	ps
t _{LOCK}	PLL Lock time ⁽¹⁾	Stable power supply, valid clocks presented on CLKIN pin			1.0	ms

Notes:

1. See Switching Waveforms on page 5.

Switching Waveforms

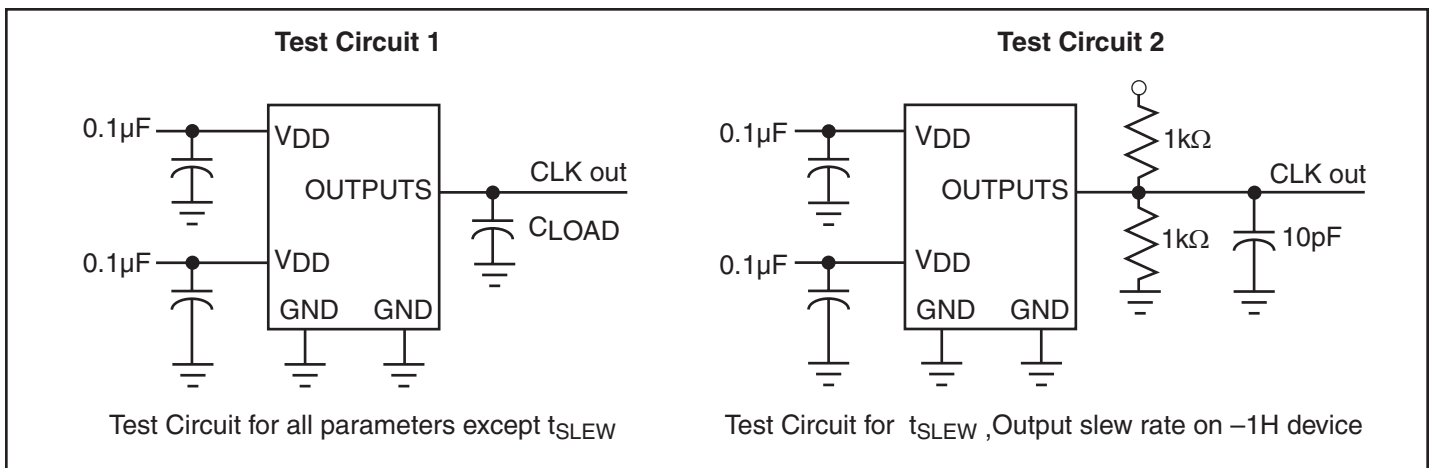
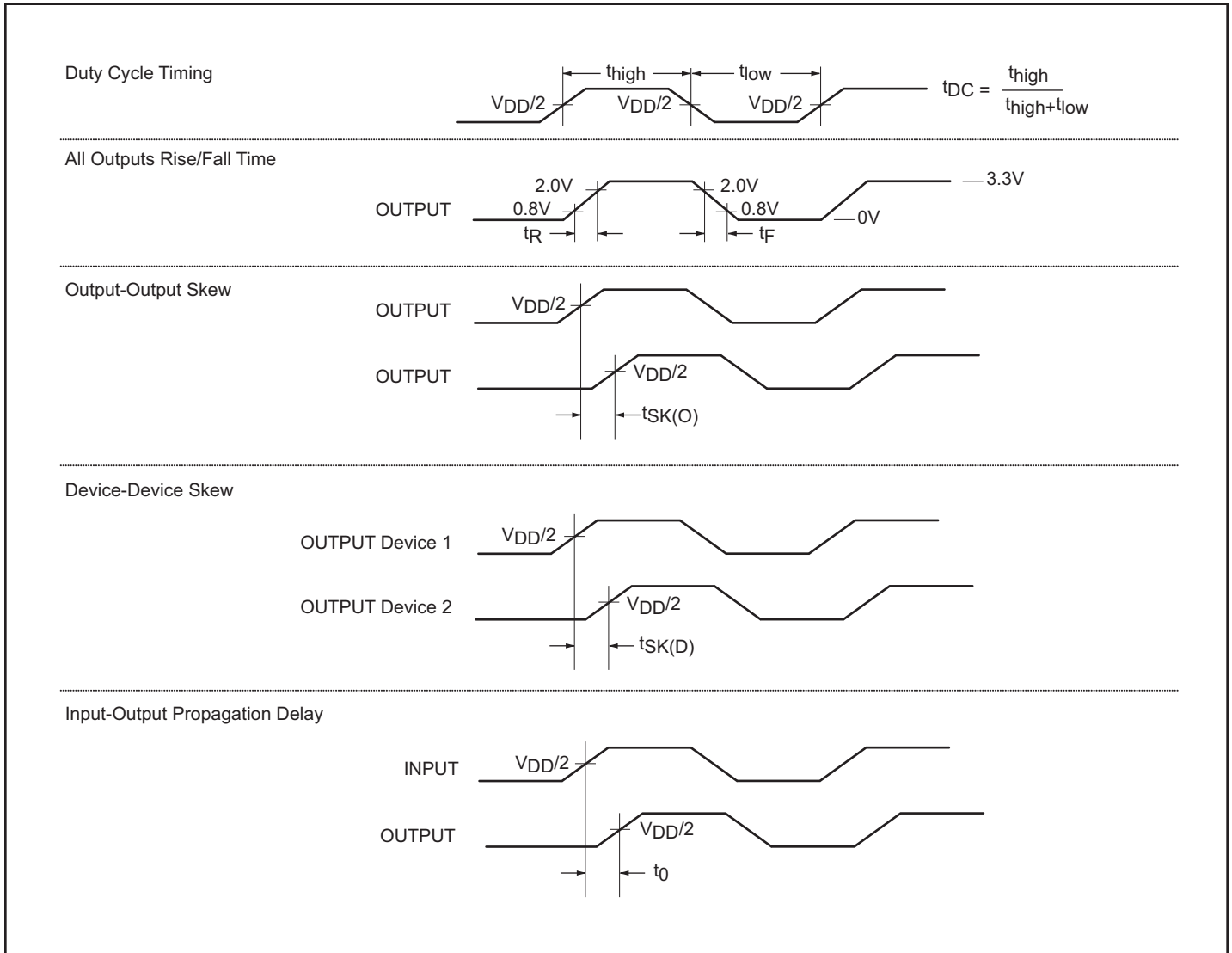

Packaging Mechanical: 8-Pin SOIC (W)

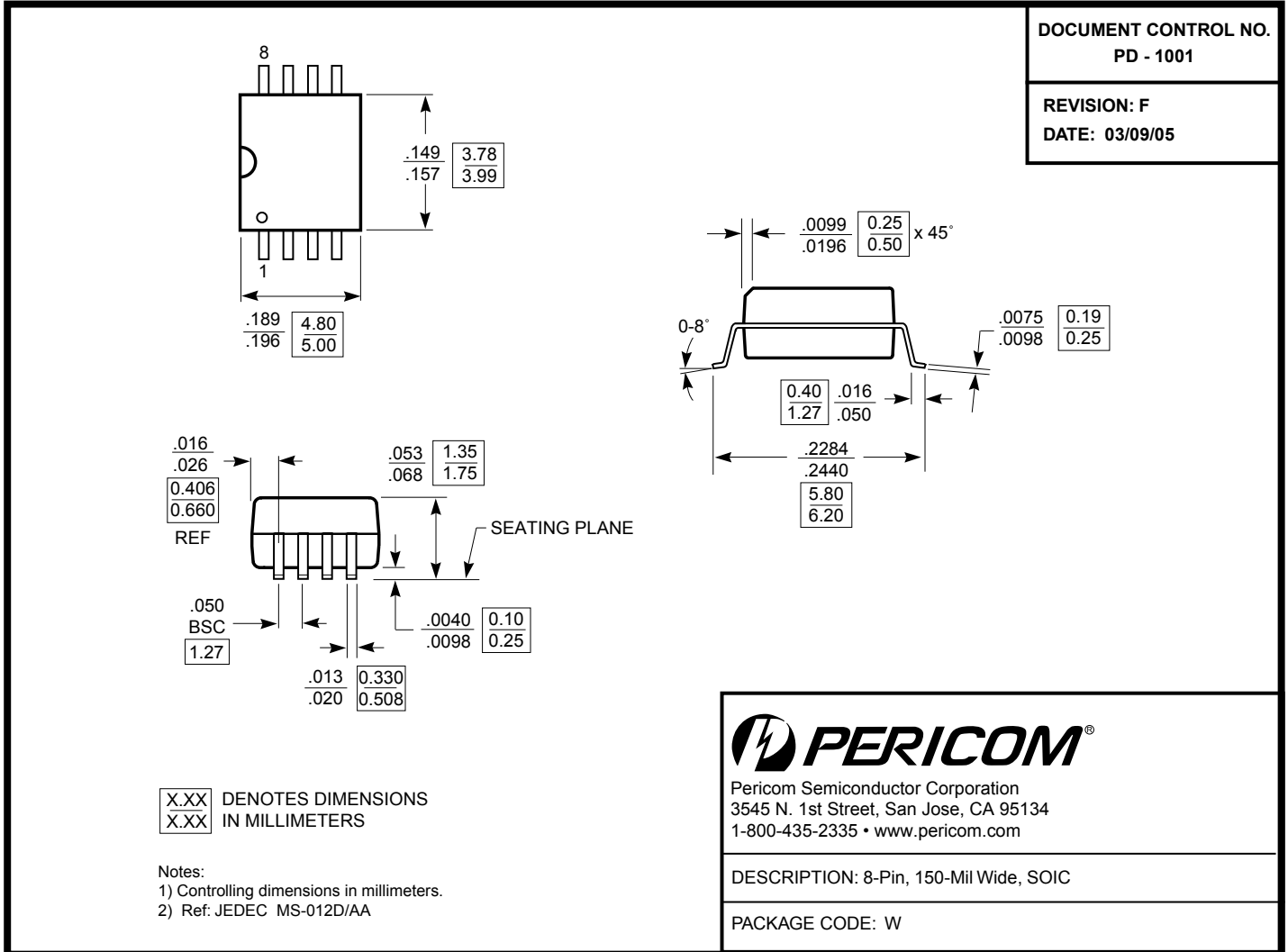

Packaging Mechanical: 8-Pin TSSOP (L)

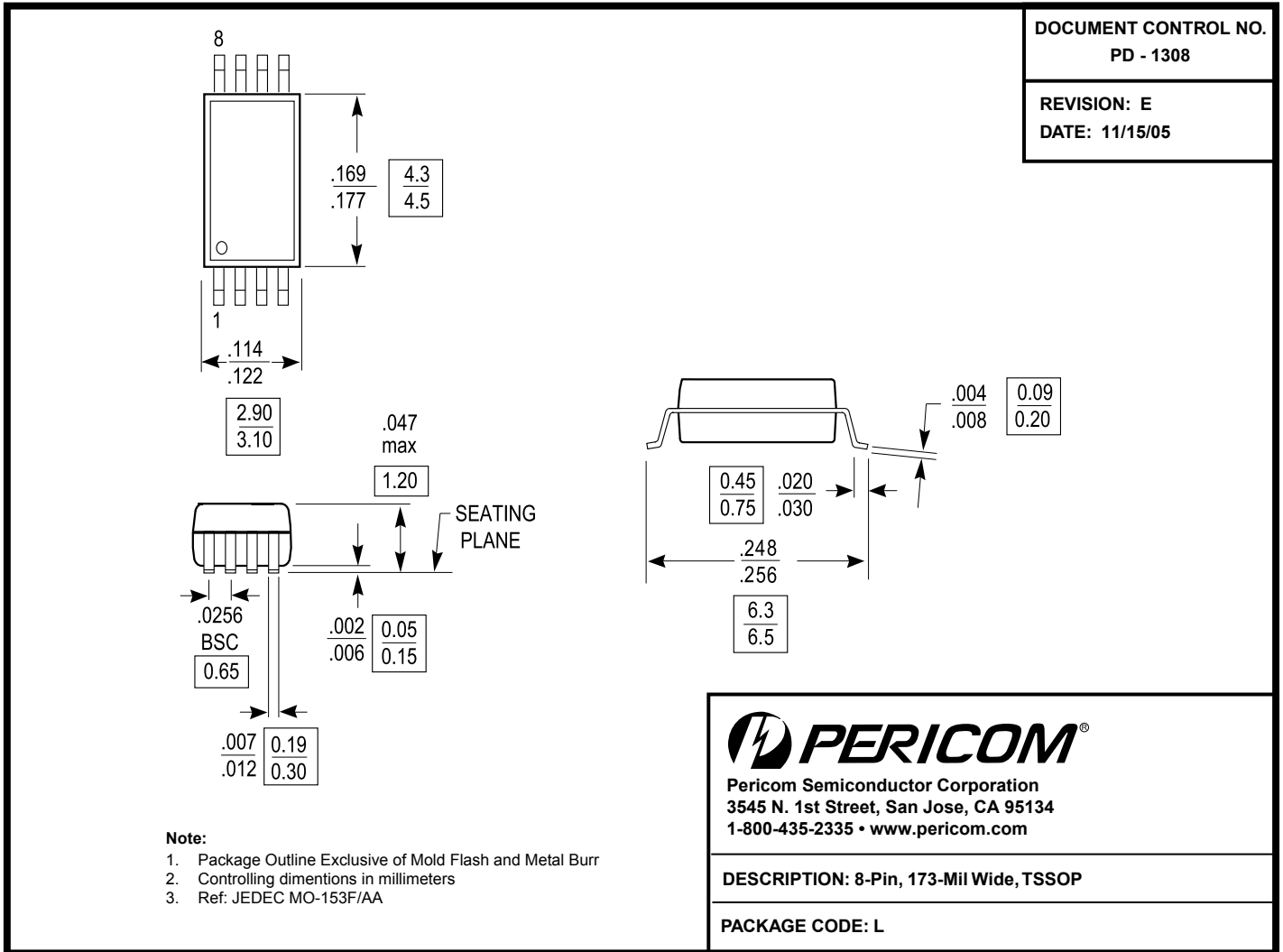

Ordering Information for Commercial Operating Ranges

Ordering Code	Package Code	Package Description
PI6C2405A-1HWE	W	Pb-free & Green, 8-pin 150-mil SOIC
PI6C2405A-1LE	L	Pb-free & Green, 8-pin 173-mil TSSOP
PI6C2405A-1HLE	L	Pb-free & Green, 8-pin 173-mil TSSOP

Ordering Information for Industrial Operating Ranges

Ordering Code	Package Code	Package Description
PI6C2405A-1HWIE	W	Pb-free & Green, 8-pin 150-mil SOIC
PI6C2405A-1LIE	L	Pb-free & Green, 8-pin 173-mil TSSOP
PI6C2405A-1HLIE	L	Pb-free & Green, 8-pin 173-mil TSSOP

Notes:

1. Thermal characteristics can be found on the company web site at www.pericom.com/packaging/
2. X = Tape/Reel
3. E = Pb-free & Green

Mouser Electronics

Authorized Distributor

Click to View Pricing, Inventory, Delivery & Lifecycle Information:

Diodes Incorporated:

[PI6C2405A-1LE](#) [PI6C2405A-1LEX](#) [PI6C2405A-1HLE](#) [PI6C2405A-1HLEX](#) [PI6C2405A-1HLIE](#) [PI6C2405A-1HLIEX](#)
[PI6C2405A-1HWE](#) [PI6C2405A-1HWEX](#) [PI6C2405A-1HWIE](#) [PI6C2405A-1HWIEX](#)



Компания «ЭлектроПласт» предлагает заключение долгосрочных отношений при поставках импортных электронных компонентов на взаимовыгодных условиях!

Наши преимущества:

- Оперативные поставки широкого спектра электронных компонентов отечественного и импортного производства напрямую от производителей и с крупнейших мировых складов;
- Поставка более 17-ти миллионов наименований электронных компонентов;
- Поставка сложных, дефицитных, либо снятых с производства позиций;
- Оперативные сроки поставки под заказ (от 5 рабочих дней);
- Экспресс доставка в любую точку России;
- Техническая поддержка проекта, помощь в подборе аналогов, поставка прототипов;
- Система менеджмента качества сертифицирована по Международному стандарту ISO 9001;
- Лицензия ФСБ на осуществление работ с использованием сведений, составляющих государственную тайну;
- Поставка специализированных компонентов (Xilinx, Altera, Analog Devices, Intersil, Interpoint, Microsemi, Aeroflex, Peregrine, Syfer, Eurofarad, Texas Instrument, Miteq, Cobham, E2V, MA-COM, Hittite, Mini-Circuits, General Dynamics и др.);

Помимо этого, одним из направлений компании «ЭлектроПласт» является направление «Источники питания». Мы предлагаем Вам помощь Конструкторского отдела:

- Подбор оптимального решения, техническое обоснование при выборе компонента;
- Подбор аналогов;
- Консультации по применению компонента;
- Поставка образцов и прототипов;
- Техническая поддержка проекта;
- Защита от снятия компонента с производства.



Как с нами связаться

Телефон: 8 (812) 309 58 32 (многоканальный)

Факс: 8 (812) 320-02-42

Электронная почта: org@eplast1.ru

Адрес: 198099, г. Санкт-Петербург, ул. Калинина, дом 2, корпус 4, литера А.