

| ITEM | Q'TY | PART NUMBER | PART DESCRIPTION |
|------|------|-------------|---|
| 1 | 1 | FLPR-XX | Flexible Light Pipe Adapter,90°, w/LED, See page 2 & 3. |
| 2 | 1 | FLPR1-XX.X | Flexible Light-Pipe Lens Cap Assembly, Rectangular |

| REV. | DESCRIPTION | DATE | APPROVED |
|------|--|----------|----------|
| A | Engineering Release. | 06/16/09 | T. Y. |
| B | Replaced 3UWC-0.6K-F with 3UWC1.035C-F | 04/26/12 | T. Y. |
| C | Updated Table For Length "L" | 11/16/12 | T. Y. |

NOTE: FLPR-XX ADAPTER SHIPPED NON-ASSEMBLED



| " L " * | Tolerance |
|------------------|-----------|
| 1.0" ~ 16.0" | ±0.050" |
| 16.1" ~ 40.0" | ±0.15" |
| 40.1" ~ 80.0" | ±0.30" |
| 80.1" ~ 3,940.0" | ±0.5% |

* Available in 0.1" increments only

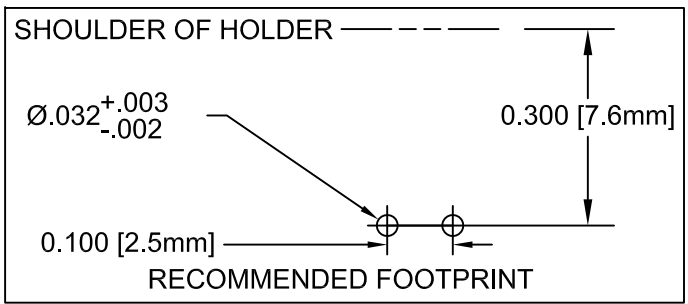
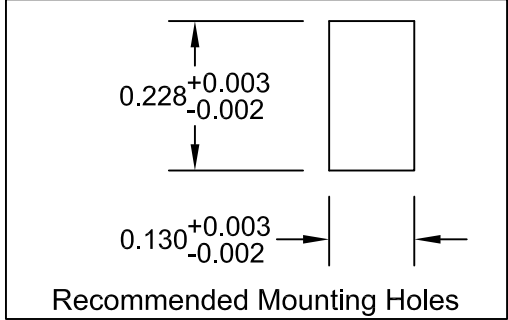
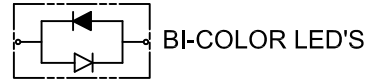

| SHORT LEAD CATHODE | LED PART NO. | LONG LEAD CATHODE |
|--------------------|--------------|-------------------|
| RED | 3xBCC-F | GREEN |
| YELLOW | 3xBCC-Y/G-F | GREEN |
| RED | 3xBCC-R/Y-F | YELLOW |
| AMBER | 3xBCC-A/G-F | GREEN |

ABSOLUTE MAXIMUM RATINGS (Ta=25°C)



| | | |
|---|-------|----------------------|
| REVERSE VOLTAGE | _____ | 5V |
| REVERSE CURRENT | _____ | 100uA |
| OPERATING TEMPERATURE RANGE | _____ | -25° C - 85° C |
| STORAGE TEMPERATURE | _____ | -30° C - 100° C |
| LEAD SOLDERING TEMPERATURE(1/16" FROM BODY) | _____ | 260° C FOR 5 SECONDS |

| | | | |
|---|--------------------------|--|-----------------------|
| STANDARD TOLERANCE (UNLESS OTHERWISE SPECIFIED) | | BIVAR ® 4 THOMAS, IRVINE, CA. 92618 TEL: (949) 951-8808 FAX: (949) 951-3974 | |
| DECIMALS | ANGULAR | | |
| .X ±.1 | X° ± 1° | | |
| .XX ±.02 | | TITLE: FLEXIBLE LIGHT-PIPE ASSY RIGHT ANGLE, RECTANGULAR LENS CAP W/LED | |
| .XXX ±.010 | | | |
| DESIGNED: Raffy Paje | DATE: 06/16/09 | PART NO: FLPR1RX.X-XX | REVISION: C |
| CHECKED: F. Jensen | DATE: 06/16/09 | CAGE CODE : 32559 | SHEET # 1 OF 3 |
| CAD GENERATED DOCUMENT, DO NOT MEASURE DRAWING. | | | |

| | | | |
|------|--------------|------|----------|
| REV. | DESCRIPTION | DATE | APPROVED |
| | SEE SHEET#1. | | |
| | | | |

| FLPR1RX.X-XX PART NO. | LED Part No. | Chip | | | Lens Appearance | Absolute Max. Ratings | | | | Electro-Optical Data @ 20mA | | | Viewing Angle 2 θ ½ (Deg) |
|--------------------------|--------------|--------------|-------------------------------|---------------|--------------------|-----------------------|------------|------------|----------------|--------------------------------|-----|-------------|------------------------------------|
| | | Material | Peak Wave Length λp(nm) | Emitted Color | | Δλ (nm) | Pd (mW) | If (mA) | Peak If(mA) | Vf (V) | | Iv (mcd) | |
| | | | | | | | | | | TYP | MAX | TYP | |
| FLPR1RX.X-SG | 3SGC-F | GaP/GaP | 568 | SUPER GREEN | WATER CLEAR | 30 | 80 | 30 | 150 | 2.2 | 2.6 | 120 | 30 |
| FLPR1RX.X-SY | 3SYC-F | GaAsP/GaP | 585 | SUPER YELLOW | WATER CLEAR | 35 | 80 | 30 | 150 | 2.1 | 2.6 | 65 | 30 |
| FLPR1RX.X-SA | 3SAC-F | AlGaInP | 620 | SUPER AMBER | WATER CLEAR | 17 | 100 | 30 | 150 | 2.0 | 2.6 | 350 | 30 |
| FLPR1RX.X-SR | 3SRC-F | GaAlAsP/GaAs | 660 | SUPER RED | WATER CLEAR | 20 | 80 | 20 | 150 | 1.7 | 2.6 | 250 | 30 |



| FLPR1RX.X-XX PART NO. | LED Part No. | Chip | | | Lens Appearance | Absolute Max. Ratings | | | | Electro-Optical Data @ 20mA | | | Viewing Angle 2 θ ½ (Deg) |
|--------------------------|--------------|-------------|-------------------------------|---------------|--------------------|-----------------------|------------|------------|----------------|--------------------------------|------|-------------|------------------------------------|
| | | Material | Peak Wave Length λp(nm) | Emitted Color | | Δλ (nm) | Pd (mW) | If (mA) | Peak If(mA) | Vf (V) | | Iv (mcd) | |
| | | | | | | | | | | Typ. | Max. | Typ. | |
| FLPR1RX.XUBW.6K | 3UBWC-0.6K-F | InGaNSiC | 466 | BLUE | WATER CLEAR | 26 | 76 | 50 | 150 | 3.5 | 4.5 | 600 | 20 |
| FLPR1RX.X-UT | 3UTC-F | InGaNSiC | 502 | TURQUOISE | WATER CLEAR | 30 | 70 | 30 | 150 | 3.5 | 4.5 | 900 | 20 |
| FLPR1RX.X-UG | 3UGC-F | InGaAlP | 563 | GREEN | WATER CLEAR | 11 | 100 | 30 | 150 | 2.2 | 2.6 | 800 | 30 |
| FLPR1RX.X-SUG | 3SUGC-F | InGaAlP | 574 | GREEN | WATER CLEAR | 22 | 100 | 30 | 150 | 2.2 | 3.0 | 1000 | 30 |
| FLPR1RX.X-UJ | 3UYC-F | InGaAlP | 588 | YELLOW | WATER CLEAR | 15 | 100 | 30 | 150 | 2.0 | 2.6 | 600 | 20 |
| FLPR1RX.X-SUY | 3SUYC-F | InGaAlP | 592 | YELLOW | WATER CLEAR | 15 | 100 | 30 | 150 | 2.0 | 2.6 | 1000 | 30 |
| FLPR1RX.X-UJY | 3UUYC-F | InGaAlP | 592 | YELLOW | WATER CLEAR | 15 | 100 | 30 | 150 | 2.1 | 2.6 | 2000 | 30 |
| FLPR1RX.X-UO | 3UOC-F | AlGaInP | 620 | ORANGE | WATER CLEAR | 17 | 100 | 30 | 150 | 2.2 | 2.6 | 1500 | 30 |
| FLPR1RX.X-SUO | 3SUOC-F | InGaAlP | 633 | ORANGE | WATER CLEAR | 17 | 100 | 30 | 150 | 2.2 | 2.6 | 2200 | 30 |
| FLPR1RX.X-UR | 3URC-F | GaAlAs/GaAs | 660 | RED | WATER CLEAR | 20 | 60 | 30 | 150 | 1.7 | 2.6 | 400 | 30 |
| FLPR1RX.X-SUR | 3SURC-F | GaAlAs/GaAs | 660 | RED | WATER CLEAR | 20 | 65 | 30 | 150 | 2.0 | 2.6 | 600 | 30 |
| FLPR1RX.XUW0.6K | 3UWC1.035C-F | InGaNSiC | X=.30 Y=.31 | WHITE | WATER CLEAR | - | 120 | 20 | 100 | 3.4 | 3.8 | 1000 | 35 |

| | | | |
|---|--------------------------|---|---|
| STANDARD TOLERANCE (UNLESS OTHERWISE SPECIFIED) ±10% ALL VALUES ANGULAR | |  BIVAR [®] 4 THOMAS, IRVINE, CA. 92618 TEL: (949) 951-8808 FAX: (949) 951-3974 | |
|  | | | |
| DESIGNED: Raffy Paje | DATE: 06/16/09 | TITLE: FLEXIBLE LIGHT-PIPE ASSY RIGHT ANGLE, RECTANGULAR LENS CAP W/LED | |
| CHECKED: F. Jensen | DATE: 06/16/09 | PART NO: FLPR1RX.X-XX CAGE CODE : 32559 | REVISION: C SHEET # 2 OF 3 |
| CAD GENERATED DOCUMENT. DO NOT MEASURE DRAWING. | | | |

| | | | |
|------|--------------|------|----------|
| REV. | DESCRIPTION | DATE | APPROVED |
| | SEE SHEET#1. | | |
| | | | |

| FLPR1RX.X-XX PART NO. | LED Part No. | Chip | | | Lens Appearance | Absolute Max. Ratings | | | | Electro-Optical Data @ 20mA | | | Viewing Angle 2 θ ½ (Deg) |
|--------------------------|--------------|-----------|-------------------------------|---------------|--------------------|-----------------------|------------|------------|----------------|--------------------------------|-----|-------------|------------------------------------|
| | | Material | Peak Wave Length λp(nm) | Emitted Color | | Δλ (nm) | Pd (mW) | If (mA) | Peak If(mA) | Vf (V) | | Iv (mcd) | |
| | | | | | | | | | | TYP | MAX | TYP | |
| FLPR1RX.X-BC | 3BCC-F | GaAsP/GaP | 635 | HE RED | WATER CLEAR | 45 | 80 | 30 | 150 | 2.1 | 2.6 | 65.0 | 45 |
| | | GaP/GaP | 568 | GREEN | | 30 | 80 | 30 | 150 | 2.2 | 2.6 | 65.0 | |
| FLPR1RX.X-BCYG | 3BCC-Y/G-F | GaAsP/GaP | 585 | YELLOW | WATER CLEAR | 35 | 80 | 30 | 150 | 2.1 | 2.6 | 50.0 | 45 |
| | | GaP/GaP | 568 | GREEN | | 30 | 80 | 30 | 150 | 2.2 | 2.6 | 60.0 | |
| FLPR1RX.X-BCRY | 3BCC-R/Y-F | GaAsP/GaP | 585 | YELLOW | WATER CLEAR | 35 | 80 | 30 | 150 | 2.1 | 2.6 | 50.0 | 45 |
| | | GaAsP/GaP | 635 | HE RED | | 30 | 80 | 30 | 150 | 2.1 | 2.6 | 60.0 | |
| FLPR1RX.X-BCAG | 3BCC-A/G-F | GaAsP/GaP | 610 | AMBER | WATER CLEAR | 35 | 80 | 30 | 150 | 2.1 | 2.6 | 50.0 | 45 |
| | | GaP/GaP | 568 | GREEN | | 30 | 80 | 30 | 150 | 2.2 | 2.6 | 60.0 | |

| FLPR1RX.X-XX PART NO. | LED Part No. | Chip | | | Lens Appearance | Absolute Max. Ratings | | | | Electro-Optical Data @ 20mA | | | Viewing Angle 2 θ ½ (Deg) |
|--------------------------|--------------|--------------|-------------------------------|---------------|--------------------|-----------------------|------------|------------|----------------|--------------------------------|-----|-------------|------------------------------------|
| | | Material | Peak Wave Length λp(nm) | Emitted Color | | Δλ (nm) | Pd (mW) | If (mA) | Peak If(mA) | Vf (V) | | Iv (mcd) | |
| | | | | | | | | | | TYP | MAX | TYP | |
| FLPR1RX.X-SBC | 3SBCC-F | GaAiAsP/GaAs | 660 | SUPER RED | WATER CLEAR | 20 | 60 | 30 | 150 | 1.8 | 2.6 | 150 | 35 |
| | | GaP/GaP | 568 | HE GREEN | | 30 | 80 | 30 | 150 | 2.2 | 2.6 | 80 | |
| FLPR1RX.X-SBCYG | 3SBCC-Y/G-F | GaAsP/GaP | 590 | SUPER YELLOW | WATER CLEAR | 15 | 100 | 30 | 150 | 2.0 | 2.6 | 400 | 35 |
| | | GaP/GaP | 568 | HE GREEN | | 30 | 100 | 30 | 150 | 2.2 | 2.6 | 80 | |
| FLPR1RX.X-SBCRY | 3SBCC-R/Y-F | GaAiAsP/GaAs | 660 | SUPER RED | WATER CLEAR | 20 | 60 | 30 | 150 | 1.8 | 2.6 | 150 | 35 |
| | | GaAsP/GaP | 590 | SUPER YELLOW | | 15 | 100 | 30 | 150 | 2.0 | 2.6 | 400 | |

| | | | |
|---|--------------------------|--|------------------------------|
| STANDARD TOLERANCE (UNLESS OTHERWISE SPECIFIED) ±10% ALL VALUES ANGULAR | |  BIVAR ® 4 THOMAS, IRVINE, CA. 92618 TEL: (949) 951-8808 FAX: (949) 951-3974 | |
|  | | | |
| DESIGNED: Raffy Paje | DATE: 06/16/09 | TITLE: FLEXIBLE LIGHT-PIPE ASSY RIGHT ANGLE, RECTANGULAR LENS CAP W/LED PART NO: FLPR1RX.X-XX REVISION: C | |
| CHECKED: F. Jensen | DATE: 06/16/09 | CAGE CODE : 32559 | SHEET # 3 OF 3 |
| CAD GENERATED DOCUMENT, DO NOT MEASURE DRAWING. | | | |



Компания «ЭлектроПласт» предлагает заключение долгосрочных отношений при поставках импортных электронных компонентов на взаимовыгодных условиях!

Наши преимущества:

- Оперативные поставки широкого спектра электронных компонентов отечественного и импортного производства напрямую от производителей и с крупнейших мировых складов;
- Поставка более 17-ти миллионов наименований электронных компонентов;
- Поставка сложных, дефицитных, либо снятых с производства позиций;
- Оперативные сроки поставки под заказ (от 5 рабочих дней);
- Экспресс доставка в любую точку России;
- Техническая поддержка проекта, помощь в подборе аналогов, поставка прототипов;
- Система менеджмента качества сертифицирована по Международному стандарту ISO 9001;
- Лицензия ФСБ на осуществление работ с использованием сведений, составляющих государственную тайну;
- Поставка специализированных компонентов (Xilinx, Altera, Analog Devices, Intersil, Interpoint, Microsemi, Aeroflex, Peregrine, Syfer, Eurofarad, Texas Instrument, Miteq, Cobham, E2V, MA-COM, Hittite, Mini-Circuits, General Dynamics и др.);

Помимо этого, одним из направлений компании «ЭлектроПласт» является направление «Источники питания». Мы предлагаем Вам помощь Конструкторского отдела:

- Подбор оптимального решения, техническое обоснование при выборе компонента;
- Подбор аналогов;
- Консультации по применению компонента;
- Поставка образцов и прототипов;
- Техническая поддержка проекта;
- Защита от снятия компонента с производства.



Как с нами связаться

Телефон: 8 (812) 309 58 32 (многоканальный)

Факс: 8 (812) 320-02-42

Электронная почта: org@eplast1.ru

Адрес: 198099, г. Санкт-Петербург, ул. Калинина, дом 2, корпус 4, литера А.