

ITEM	Q'TY	PART NUMBER	PART DESCRIPTION
1	1	FLPR-XX	Flexible Light Pipe Adapter,90°, w/LED, See page 2 & 3.
2	1	FLPR1-XX.X	Flexible Light-Pipe Lens Cap Assembly, Rectangular

REV.	DESCRIPTION	DATE	APPROVED
A	Engineering Release.	06/16/09	T. Y.
B	Replaced 3UWC-0.6K-F with 3UWC1.035C-F	04/26/12	T. Y.
C	Updated Table For Length "L"	11/16/12	T. Y.

NOTE: FLPR-XX ADAPTER SHIPPED NON-ASSEMBLED



" L " *	Tolerance
1.0" ~ 16.0"	±0.050"
16.1" ~ 40.0"	±0.15"
40.1" ~ 80.0"	±0.30"
80.1" ~ 3,940.0"	±0.5%

\* Available in 0.1" increments only

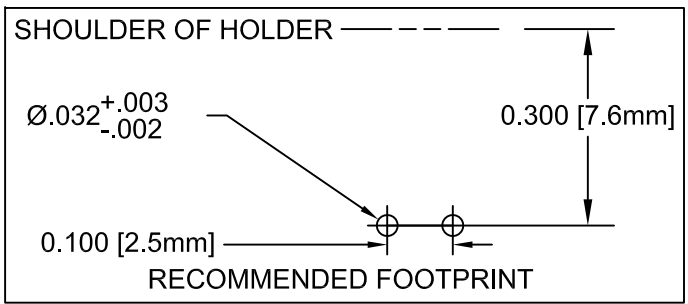
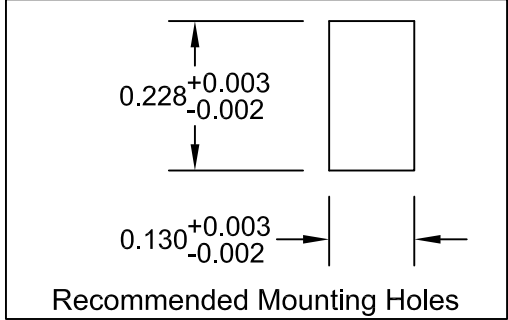
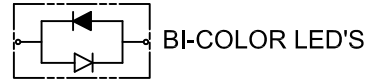

SHORT LEAD CATHODE	LED PART NO.	LONG LEAD CATHODE
RED	3xBCC-F	GREEN
YELLOW	3xBCC-Y/G-F	GREEN
RED	3xBCC-R/Y-F	YELLOW
AMBER	3xBCC-A/G-F	GREEN

### ABSOLUTE MAXIMUM RATINGS (Ta=25°C)



REVERSE VOLTAGE	_____	5V
REVERSE CURRENT	_____	100uA
OPERATING TEMPERATURE RANGE	_____	-25° C - 85° C
STORAGE TEMPERATURE	_____	-30° C - 100° C
LEAD SOLDERING TEMPERATURE(1/16" FROM BODY)	_____	260° C FOR 5 SECONDS

STANDARD TOLERANCE (UNLESS OTHERWISE SPECIFIED)		<b>BIVAR</b> <sup>®</sup> 4 THOMAS, IRVINE, CA. 92618 TEL: (949) 951-8808 FAX: (949) 951-3974
DECIMALS	ANGULAR	
.X ±.1	X° ± 1°	
.XX ±.02		<b>TITLE:</b> FLEXIBLE LIGHT-PIPE ASSY RIGHT ANGLE, RECTANGULAR LENS CAP W/LED <b>PART NO:</b> FLPR1RX.X-XX <b>REVISION:</b> C
.XXX ±.010		
DESIGNED: <b>Raffy Paje</b>	DATE: <b>06/16/09</b>	<b>CAGE CODE :</b> 32559 <b>SHEET #</b> 1 <b>OF</b> 3 <small>CAD GENERATED DOCUMENT, DO NOT MEASURE DRAWING.</small>
CHECKED: <b>F. Jensen</b>	DATE: <b>06/16/09</b>	

REV.	DESCRIPTION	DATE	APPROVED
	SEE SHEET#1.		

FLPR1RX.X-XX PART NO.	LED Part No.	Chip			Lens Appearance	Absolute Max. Ratings				Electro-Optical Data @ 20mA			Viewing Angle 2 θ ½ (Deg)
		Material	Peak Wave Length λp(nm)	Emitted Color		Δλ (nm)	Pd (mW)	If (mA)	Peak If(mA)	Vf (V)		Iv (mcd)	
										TYP	MAX	TYP	
FLPR1RX.X-SG	3SGC-F	GaP/GaP	568	SUPER GREEN	WATER CLEAR	30	80	30	150	2.2	2.6	120	30
FLPR1RX.X-SY	3SYC-F	GaAsP/GaP	585	SUPER YELLOW	WATER CLEAR	35	80	30	150	2.1	2.6	65	30
FLPR1RX.X-SA	3SAC-F	AlGaInP	620	SUPER AMBER	WATER CLEAR	17	100	30	150	2.0	2.6	350	30
FLPR1RX.X-SR	3SRC-F	GaAiAsP/GaAs	660	SUPER RED	WATER CLEAR	20	80	20	150	1.7	2.6	250	30



FLPR1RX.X-XX PART NO.	LED Part No.	Chip			Lens Appearance	Absolute Max. Ratings				Electro-Optical Data @ 20mA			Viewing Angle 2 θ ½ (Deg)
		Material	Peak Wave Length λp(nm)	Emitted Color		Δλ (nm)	Pd (mW)	If (mA)	Peak If(mA)	Vf (V)		Iv (mcd)	
										Typ.	Max.	Typ.	
FLPR1RX.XUBW.6K	3UBWC-0.6K-F	InGaNSiC	466	BLUE	WATER CLEAR	26	76	50	150	3.5	4.5	600	20
FLPR1RX.X-UT	3UTC-F	InGaNSiC	502	TURQUOISE	WATER CLEAR	30	70	30	150	3.5	4.5	900	20
FLPR1RX.X-UG	3UGC-F	InGaAlP	563	GREEN	WATER CLEAR	11	100	30	150	2.2	2.6	800	30
FLPR1RX.X-SUG	3SUGC-F	InGaAlP	574	GREEN	WATER CLEAR	22	100	30	150	2.2	3.0	1000	30
FLPR1RX.X-UJ	3UYC-F	InGaAlP	588	YELLOW	WATER CLEAR	15	100	30	150	2.0	2.6	600	20
FLPR1RX.X-SUY	3SUYC-F	InGaAlP	592	YELLOW	WATER CLEAR	15	100	30	150	2.0	2.6	1000	30
FLPR1RX.X-UJY	3UUYC-F	InGaAlP	592	YELLOW	WATER CLEAR	15	100	30	150	2.1	2.6	2000	30
FLPR1RX.X-UO	3UOC-F	AlGaInP	620	ORANGE	WATER CLEAR	17	100	30	150	2.2	2.6	1500	30
FLPR1RX.X-SUO	3SUOC-F	InGaAlP	633	ORANGE	WATER CLEAR	17	100	30	150	2.2	2.6	2200	30
FLPR1RX.X-UR	3URC-F	GaAlAs/GaAs	660	RED	WATER CLEAR	20	60	30	150	1.7	2.6	400	30
FLPR1RX.X-SUR	3SURC-F	GaAlAs/GaAs	660	RED	WATER CLEAR	20	65	30	150	2.0	2.6	600	30
FLPR1RX.XUW0.6K	3UWC1.035C-F	InGaNSiC	X=.30 Y=.31	WHITE	WATER CLEAR	-	120	20	100	3.4	3.8	1000	35

STANDARD TOLERANCE ( UNLESS OTHERWISE SPECIFIED ) ±10% ALL VALUES      ANGULAR		 <b>BIVAR</b> ® 4 THOMAS, IRVINE, CA. 92618 TEL: (949) 951-8808    FAX: (949) 951-3974	
			
DESIGNED: <b>Raffy Paje</b>	DATE: <b>06/16/09</b>	<b>PART NO:</b> FLPR1RX.X-XX	
CHECKED: <b>F. Jensen</b>	DATE: <b>06/16/09</b>	<b>CAGE CODE :</b> 32559	<b>SHEET # 2 OF 3</b>
CAD GENERATED DOCUMENT. DO NOT MEASURE DRAWING.			

REV.	DESCRIPTION	DATE	APPROVED
	SEE SHEET#1.		

FLPR1RX.X-XX PART NO.	LED Part No.	Chip			Lens Appearance	Absolute Max. Ratings				Electro-Optical Data @ 20mA			Viewing Angle 2 θ ½ (Deg)
		Material	Peak Wave Length λp(nm)	Emitted Color		Δλ (nm)	Pd (mW)	If (mA)	Peak If(mA)	Vf (V)		Iv (mcd)	
										TYP	MAX	TYP	
FLPR1RX.X-BC	3BCC-F	GaAsP/GaP	635	HE RED	WATER CLEAR	45	80	30	150	2.1	2.6	65.0	45
		GaP/GaP	568	GREEN		30	80	30	150	2.2	2.6	65.0	
FLPR1RX.X-BCYG	3BCC-Y/G-F	GaAsP/GaP	585	YELLOW	WATER CLEAR	35	80	30	150	2.1	2.6	50.0	45
		GaP/GaP	568	GREEN		30	80	30	150	2.2	2.6	60.0	
FLPR1RX.X-BCRY	3BCC-R/Y-F	GaAsP/GaP	585	YELLOW	WATER CLEAR	35	80	30	150	2.1	2.6	50.0	45
		GaAsP/GaP	635	HE RED		30	80	30	150	2.1	2.6	60.0	
FLPR1RX.X-BCAG	3BCC-A/G-F	GaAsP/GaP	610	AMBER	WATER CLEAR	35	80	30	150	2.1	2.6	50.0	45
		GaP/GaP	568	GREEN		30	80	30	150	2.2	2.6	60.0	

FLPR1RX.X-XX PART NO.	LED Part No.	Chip			Lens Appearance	Absolute Max. Ratings				Electro-Optical Data @ 20mA			Viewing Angle 2 θ ½ (Deg)
		Material	Peak Wave Length λp(nm)	Emitted Color		Δλ (nm)	Pd (mW)	If (mA)	Peak If(mA)	Vf (V)		Iv (mcd)	
										TYP	MAX	TYP	
FLPR1RX.X-SBC	3SBCC-F	GaAiAsP/GaAs	660	SUPER RED	WATER CLEAR	20	60	30	150	1.8	2.6	150	35
		GaP/GaP	568	HE GREEN		30	80	30	150	2.2	2.6	80	
FLPR1RX.X-SBCYG	3SBCC-Y/G-F	GaAsP/GaP	590	SUPER YELLOW	WATER CLEAR	15	100	30	150	2.0	2.6	400	35
		GaP/GaP	568	HE GREEN		30	100	30	150	2.2	2.6	80	
FLPR1RX.X-SBCRY	3SBCC-R/Y-F	GaAiAsP/GaAs	660	SUPER RED	WATER CLEAR	20	60	30	150	1.8	2.6	150	35
		GaAsP/GaP	590	SUPER YELLOW		15	100	30	150	2.0	2.6	400	

STANDARD TOLERANCE ( UNLESS OTHERWISE SPECIFIED ) ±10% ALL VALUES      ANGULAR		 <b>BIVAR</b> ® 4 THOMAS, IRVINE, CA. 92618 TEL: (949) 951-8808    FAX: (949) 951-3974	
			
DESIGNED: <b>Raffy Paje</b>	DATE: <b>06/16/09</b>	TITLE: FLEXIBLE LIGHT-PIPE ASSY RIGHT ANGLE, RECTANGULAR LENS CAP W/LED	REVISION: <b>C</b>
CHECKED: <b>F. Jensen</b>	DATE: <b>06/16/09</b>	PART NO: <b>FLPR1RX.X-XX</b>	CAGE CODE : 32559    SHEET # 3 OF 3
CAD GENERATED DOCUMENT, DO NOT MEASURE DRAWING.			



Компания «ЭлектроПласт» предлагает заключение долгосрочных отношений при поставках импортных электронных компонентов на взаимовыгодных условиях!

Наши преимущества:

- Оперативные поставки широкого спектра электронных компонентов отечественного и импортного производства напрямую от производителей и с крупнейших мировых складов;
- Поставка более 17-ти миллионов наименований электронных компонентов;
- Поставка сложных, дефицитных, либо снятых с производства позиций;
- Оперативные сроки поставки под заказ (от 5 рабочих дней);
- Экспресс доставка в любую точку России;
- Техническая поддержка проекта, помощь в подборе аналогов, поставка прототипов;
- Система менеджмента качества сертифицирована по Международному стандарту ISO 9001;
- Лицензия ФСБ на осуществление работ с использованием сведений, составляющих государственную тайну;
- Поставка специализированных компонентов (Xilinx, Altera, Analog Devices, Intersil, Interpoint, Microsemi, Aeroflex, Peregrine, Syfer, Eurofarad, Texas Instrument, Miteq, Cobham, E2V, MA-COM, Hittite, Mini-Circuits, General Dynamics и др.);

Помимо этого, одним из направлений компании «ЭлектроПласт» является направление «Источники питания». Мы предлагаем Вам помощь Конструкторского отдела:

- Подбор оптимального решения, техническое обоснование при выборе компонента;
- Подбор аналогов;
- Консультации по применению компонента;
- Поставка образцов и прототипов;
- Техническая поддержка проекта;
- Защита от снятия компонента с производства.



#### Как с нами связаться

**Телефон:** 8 (812) 309 58 32 (многоканальный)

**Факс:** 8 (812) 320-02-42

**Электронная почта:** [org@eplast1.ru](mailto:org@eplast1.ru)

**Адрес:** 198099, г. Санкт-Петербург, ул. Калинина, дом 2, корпус 4, литера А.