



Micro Commercial Components

Micro Commercial Components  
 20736 Marilla Street Chatsworth  
 CA 91311  
 Phone: (818) 701-4933  
 Fax: (818) 701-4939

# SI2303

## P-Channel Enhancement Mode Field Effect Transistor

### Features

- Halogen free available upon request by adding suffix "-HF"
- -30V, -2.6A,  $R_{DS(ON)}=130m\Omega$  @  $V_{GS}=-10V$
- -30V, -2.0A,  $R_{DS(ON)}=180m\Omega$  @  $V_{GS}=-4.5V$
- High dense cell design for extremely low  $R_{DS(ON)}$
- Rugged and reliable
- Lead free product is acquired
- SOT-23 Package
- Marking Code: S3
- Epoxy meets UL 94 V-0 flammability rating
- Moisture Sensitivity Level 1

### Maximum Ratings @ 25°C Unless Otherwise Specified

Symbol	Parameter	Rating	Unit
$V_{DS}$	Drain-source Voltage	-30	V
$I_D$	Drain Current-Continuous	-3	A
$I_{DM}$	Drain Current-Pulsed <sup>a</sup>	-10	A
$V_{GS}$	Gate-source Voltage	$\pm 20$	V
$P_D$	Total Power Dissipation	0.25	W
$R_{\theta JA}$	Thermal Resistance Junction to Ambient <sup>b</sup>	500	$^{\circ}C/W$
$T_J$	Operating Junction Temperature	-55 to +150	$^{\circ}C$
$T_{STG}$	Storage Temperature	-55 to +150	$^{\circ}C$

### SOT-23

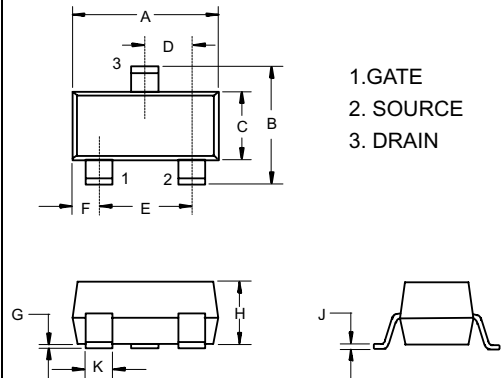

DIM	INCHES		MM		NOTE
	MIN	MAX	MIN	MAX	
A	.110	.120	2.80	3.04	
B	.083	.104	2.10	2.64	
C	.047	.055	1.20	1.40	
D	.035	.041	.89	1.03	
E	.070	.081	1.78	2.05	
F	.018	.024	.45	.60	
G	.0005	.0039	.013	.100	
H	.035	.044	.89	1.12	
J	.003	.007	.085	.180	
K	.015	.020	.37	.51	

### Internal Block Diagram

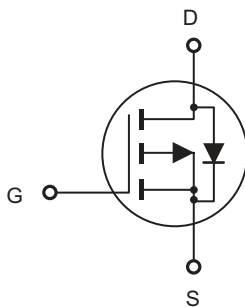

### Suggested Solder Pad Layout

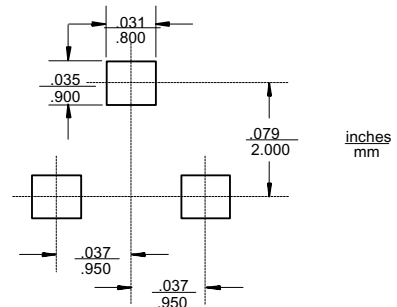

**Electrical Characteristics**  $T_A = 25^\circ\text{C}$  unless otherwise noted

Parameter	Symbol	Test Condition	Min	Typ	Max	Units	
<b>Off Characteristics</b>							
Drain-Source Breakdown Voltage	BV <sub>DSS</sub>	V <sub>GS</sub> = 0V, I <sub>D</sub> = -10 $\mu$ A	-30			V	
Zero Gate Voltage Drain Current	I <sub>DSS</sub>	V <sub>DS</sub> = -30V, V <sub>GS</sub> = 0V			-1	$\mu$ A	
Gate Body Leakage Current, Forward	I <sub>GSSF</sub>	V <sub>GS</sub> = 20V, V <sub>DS</sub> = 0V			100	nA	
Gate Body Leakage Current, Reverse	I <sub>GSSR</sub>	V <sub>GS</sub> = -20V, V <sub>DS</sub> = 0V			-100	nA	
<b>On Characteristics<sup>c</sup></b>							
Gate Threshold Voltage	V <sub>GS(th)</sub>	V <sub>GS</sub> = V <sub>DS</sub> , I <sub>D</sub> = -250 $\mu$ A	-1		-3	V	
Static Drain-Source On-Resistance	R <sub>DS(on)</sub>	V <sub>GS</sub> = -10V, I <sub>D</sub> = -2.6A			130	m $\Omega$	
		V <sub>GS</sub> = -4.5V, I <sub>D</sub> = -2.0A			180	m $\Omega$	
Forward Transconductance	g <sub>FS</sub>	V <sub>DS</sub> = -10V, I <sub>D</sub> = -1.7A		2.4		S	
<b>Dynamic Characteristics<sup>d</sup></b>							
Input Capacitance	C <sub>iss</sub>	V <sub>DS</sub> = -15V, V <sub>GS</sub> = 0V, f = 1.0 MHz		226		pF	
Output Capacitance	C <sub>oss</sub>				87		pF
Reverse Transfer Capacitance	C <sub>rss</sub>				19		pF
<b>Switching Characteristics<sup>d</sup></b>							
Turn-On Delay Time	t <sub>d(on)</sub>	V <sub>DD</sub> = -15V, I <sub>D</sub> = -1A, V <sub>GEN</sub> = -10V, R <sub>G</sub> = 6 $\Omega$ , R <sub>L</sub> = 15 $\Omega$		9	20	ns	
Turn-On Rise Time	t <sub>r</sub>			9	20	ns	
Turn-Off Delay Time	t <sub>d(off)</sub>			18	35	ns	
Turn-Off Fall Time	t <sub>f</sub>			6	20	ns	
Total Gate Charge	Q <sub>g</sub>	V <sub>DS</sub> = -15V, I <sub>D</sub> = -1.7A, V <sub>GS</sub> = -10V		5.8	10	nC	
Gate-Source Charge	Q <sub>gs</sub>			0.8		nC	
Gate-Drain Charge	Q <sub>gd</sub>			1.5		nC	
<b>Drain-Source Diode Characteristics and Maximum Ratings</b>							
Drain-Source Diode Forward Voltage <sup>c</sup>	V <sub>SD</sub>	V <sub>GS</sub> = 0V, I <sub>S</sub> = -1.25A			-1.2	V	

**Notes :**

a. Repetitive Rating : Pulse width limited by maximum junction temperature.

b. Surface Mounted on FR4 Board, t &lt; 10 sec.

c. Pulse Test : Pulse Width < 300 $\mu$ s, Duty Cycle < 2%.

d. Guaranteed by design, not subject to production testing.

## Typical characteristics

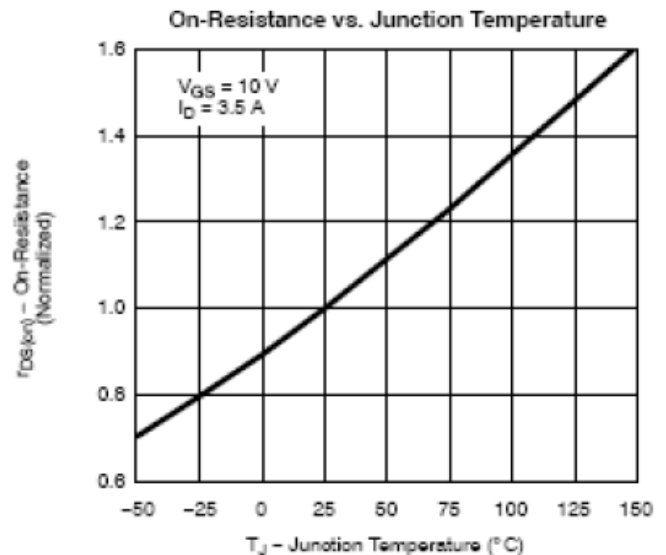
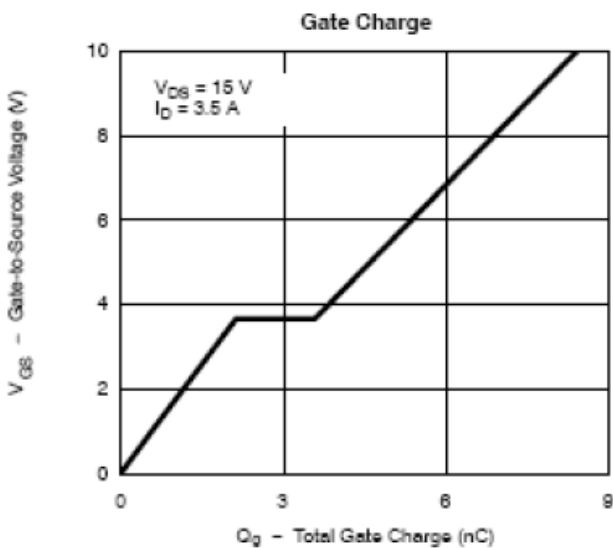
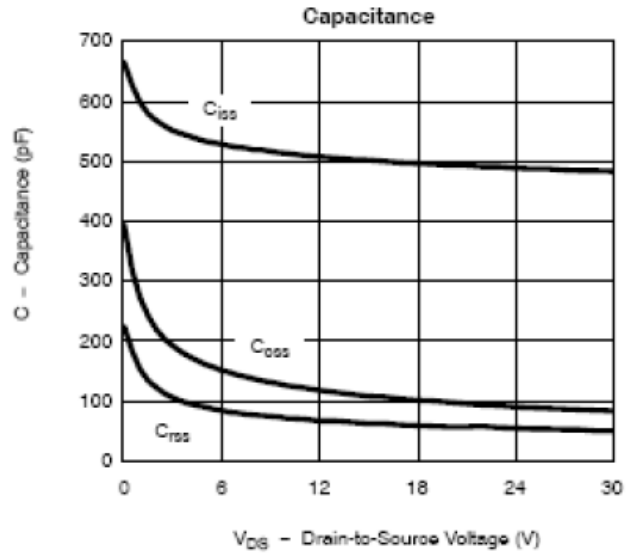
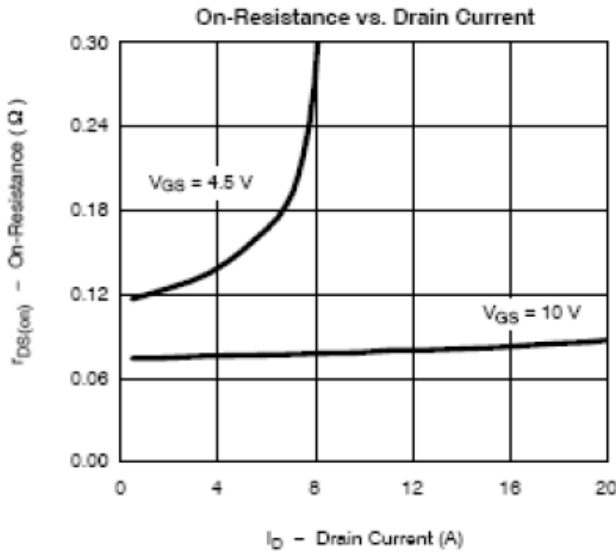
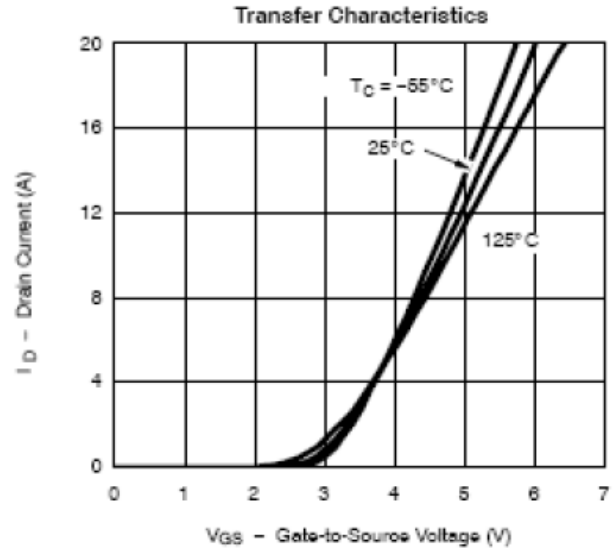
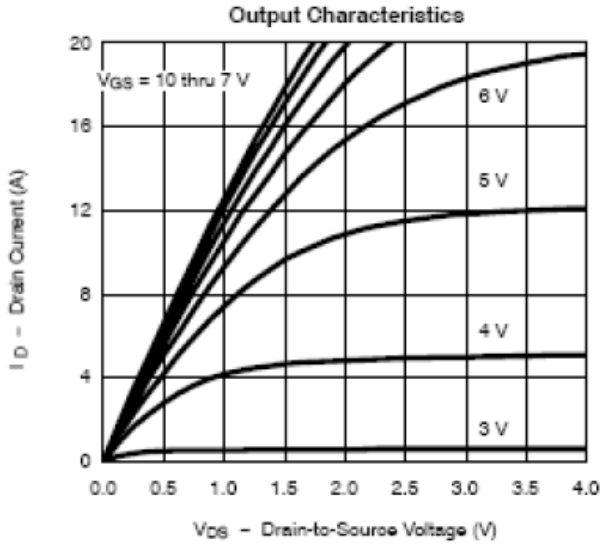

## Typical characteristics

Source-Drain Diode Forward Voltage

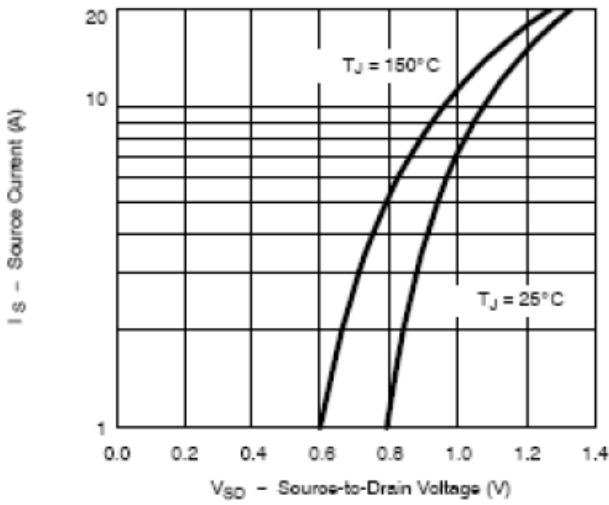

On-Resistance vs. Gate-to-Source Voltage

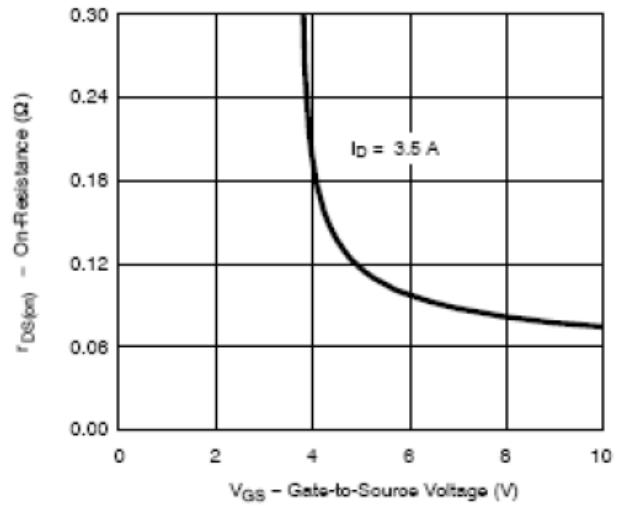

Threshold Voltage

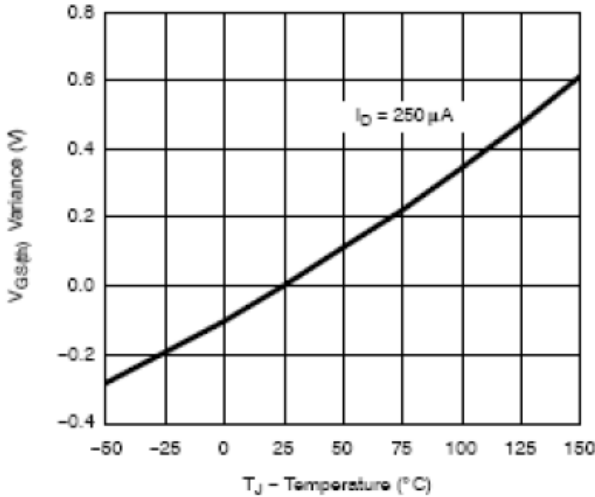

Single Pulse Power

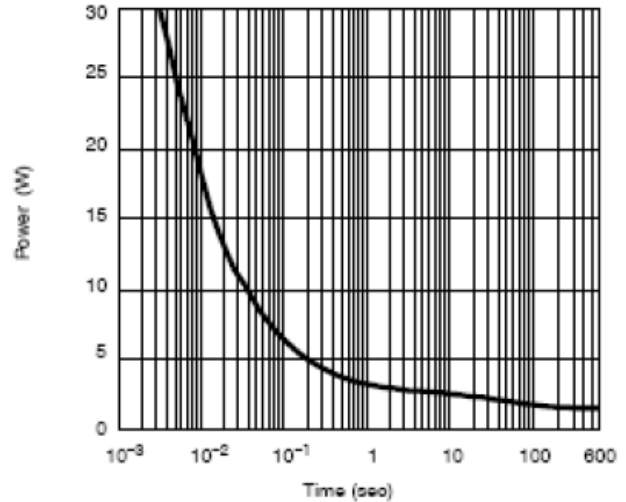

Normalized Thermal Transient Impedance, Junction-to-Ambient

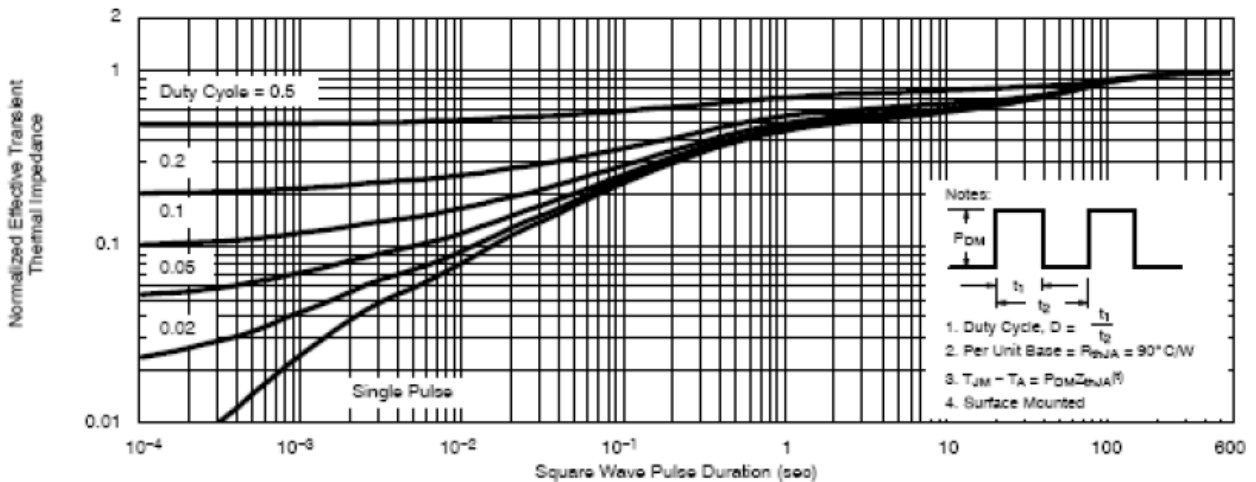



TM

Micro Commercial Components

### Ordering Information :

Device	Packing
Part Number-TP	Tape&Reel: 3Kpcs/Reel

Note : Adding "-HF" suffix for halogen free, eg. Part Number-TP-HF

#### \*\*\*IMPORTANT NOTICE\*\*\*

**Micro Commercial Components Corp.** reserves the right to make changes without further notice to any product herein to make corrections, modifications , enhancements , improvements , or other changes . **Micro Commercial Components Corp .** does not assume any liability arising out of the application or use of any product described herein; neither does it convey any license under its patent rights ,nor the rights of others . The user of products in such applications shall assume all risks of such use and will agree to hold **Micro Commercial Components Corp .** and all the companies whose products are represented on our website, harmless against all damages.

#### \*\*\*LIFE SUPPORT\*\*\*

MCC's products are not authorized for use as critical components in life support devices or systems without the express written approval of Micro Commercial Components Corporation.

#### \*\*\*CUSTOMER AWARENESS\*\*\*

Counterfeiting of semiconductor parts is a growing problem in the industry. Micro Commercial Components (MCC) is taking strong measures to protect ourselves and our customers from the proliferation of counterfeit parts. MCC strongly encourages customers to purchase MCC parts either directly from MCC or from Authorized MCC Distributors who are listed by country on our web page cited below. Products customers buy either from MCC directly or from Authorized MCC Distributors are genuine parts, have full traceability, meet MCC's quality standards for handling and storage. **MCC will not provide any warranty coverage or other assistance for parts bought from Unauthorized Sources.** MCC is committed to combat this global problem and encourage our customers to do their part in stopping this practice by buying direct or from authorized distributors.

[www.mccsemi.com](http://www.mccsemi.com)



Компания «ЭлектроПласт» предлагает заключение долгосрочных отношений при поставках импортных электронных компонентов на взаимовыгодных условиях!

Наши преимущества:

- Оперативные поставки широкого спектра электронных компонентов отечественного и импортного производства напрямую от производителей и с крупнейших мировых складов;
- Поставка более 17-ти миллионов наименований электронных компонентов;
- Поставка сложных, дефицитных, либо снятых с производства позиций;
- Оперативные сроки поставки под заказ (от 5 рабочих дней);
- Экспресс доставка в любую точку России;
- Техническая поддержка проекта, помощь в подборе аналогов, поставка прототипов;
- Система менеджмента качества сертифицирована по Международному стандарту ISO 9001;
- Лицензия ФСБ на осуществление работ с использованием сведений, составляющих государственную тайну;
- Поставка специализированных компонентов (Xilinx, Altera, Analog Devices, Intersil, Interpoint, Microsemi, Aeroflex, Peregrine, Syfer, Eurofarad, Texas Instrument, Miteq, Cobham, E2V, MA-COM, Hittite, Mini-Circuits, General Dynamics и др.);

Помимо этого, одним из направлений компании «ЭлектроПласт» является направление «Источники питания». Мы предлагаем Вам помощь Конструкторского отдела:

- Подбор оптимального решения, техническое обоснование при выборе компонента;
- Подбор аналогов;
- Консультации по применению компонента;
- Поставка образцов и прототипов;
- Техническая поддержка проекта;
- Защита от снятия компонента с производства.



#### Как с нами связаться

**Телефон:** 8 (812) 309 58 32 (многоканальный)

**Факс:** 8 (812) 320-02-42

**Электронная почта:** [org@eplast1.ru](mailto:org@eplast1.ru)

**Адрес:** 198099, г. Санкт-Петербург, ул. Калинина, дом 2, корпус 4, литера А.