



ON Semiconductor®

<http://onsemi.com>

CPH3362

Power MOSFET –100V, 1.7Ω, –0.7A, Single P-Channel

Features

- On-resistance $R_{DS(on)1}=1.3\Omega$ (typ)
- 4V drive
- Halogen free compliance

Specifications

Absolute Maximum Ratings at $T_a = 25^\circ\text{C}$

| Parameter | Symbol | Conditions | Value | Unit |
|-------------------------|-----------|---|-------------|------|
| Drain to Source Voltage | V_{DSS} | | –100 | V |
| Gate to Source Voltage | V_{GSS} | | ±20 | V |
| Drain Current (DC) | I_D | | –0.7 | A |
| Drain Current (Pulse) | I_{DP} | $PW \leq 10\mu\text{s}$, duty cycle $\leq 1\%$ | –2.8 | A |
| Power Dissipation | P_D | When mounted on ceramic substrate (900mm ² ×0.8mm) | 1 | W |
| Junction Temperature | T_j | | 150 | °C |
| Storage Temperature | T_{stg} | | –55 to +150 | °C |

This product is designed to “ESD immunity < 200V*”, so please take care when handling.

* Machine Model

Stresses exceeding those listed in the Maximum Ratings table may damage the device. If any of these limits are exceeded, device functionality should not be assumed, damage may occur and reliability may be affected.

Thermal Resistance Ratings

| Parameter | Symbol | Value | Unit |
|--|-----------------|-------|------|
| Junction to Ambient When mounted on ceramic substrate (900mm ² ×0.8mm) | $R_{\theta JA}$ | 125 | °C/W |

Electrical Characteristics

 at $T_a = 25^\circ\text{C}$

| Parameter | Symbol | Conditions | Value | | | Unit |
|--|---------------|--|-------|------|------|------|
| | | | min | typ | max | |
| Drain to Source Breakdown Voltage | $V_{(BR)DSS}$ | $I_D = -1\text{mA}$, $V_{GS} = 0\text{V}$ | –100 | | | V |
| Zero-Gate Voltage Drain Current | I_{DSS} | $V_{DS} = -100\text{V}$, $V_{GS} = 0\text{V}$ | | | –1 | μA |
| Gate to Source Leakage Current | I_{GSS} | $V_{GS} = \pm 16\text{V}$, $V_{DS} = 0\text{V}$ | | | ±10 | μA |
| Gate Threshold Voltage | $V_{GS(th)}$ | $V_{DS} = -10\text{V}$, $I_D = -1\text{mA}$ | –1.2 | | –2.6 | V |
| Forward Transconductance | g_{FS} | $V_{DS} = -10\text{V}$, $I_D = -0.3\text{A}$ | | 1.0 | | S |
| Static Drain to Source On-State Resistance | $R_{DS(on)1}$ | $I_D = -0.7\text{A}$, $V_{GS} = -10\text{V}$ | | 1.3 | 1.7 | Ω |
| | $R_{DS(on)2}$ | $I_D = -0.3\text{A}$, $V_{GS} = -4.5\text{V}$ | | 1.4 | 1.96 | Ω |
| | $R_{DS(on)3}$ | $I_D = -0.3\text{A}$, $V_{GS} = -4\text{V}$ | | 1.45 | 2.1 | Ω |
| Input Capacitance | C_{iss} | $V_{DS} = -20\text{V}$, $f = 1\text{MHz}$ | | 142 | | pF |
| Output Capacitance | C_{oss} | | | 12 | | pF |
| Reverse Transfer Capacitance | C_{rss} | | | 7.3 | | pF |

Continued on next page.

ORDERING INFORMATION

See detailed ordering and shipping information on page 2 of this data sheet.

CPH3362

Continued from preceding page.

| Parameter | Symbol | Conditions | Value | | | Unit |
|-------------------------------|--------------|---------------------------------------|-------|-------|------|------|
| | | | min | Typ | max | |
| Turn-ON Delay Time | $t_{d(on)}$ | See specified Test Circuit | | 3.9 | | ns |
| Rise Time | t_r | | | 3.4 | | ns |
| Turn-OFF Delay Time | $t_{d(off)}$ | | | 28 | | ns |
| Fall Time | t_f | | | 12 | | ns |
| Total Gate Charge | Q_g | $V_{DS}=-50V, V_{GS}=-10V, I_D=-0.7A$ | | 3.7 | | nC |
| Gate to Source Charge | Q_{gs} | | | 0.37 | | nC |
| Gate to Drain "Miller" Charge | Q_{gd} | | | 0.86 | | nC |
| Forward Diode Voltage | V_{SD} | $I_S=-0.7A, V_{GS}=0V$ | | -0.83 | -1.2 | V |

Product parametric performance is indicated in the Electrical Characteristics for the listed test conditions, unless otherwise noted. Product performance may not be indicated by the Electrical Characteristics if operated under different conditions.

Ordering & Package Information

| Device | Package | Shipping | note |
|--------------|-------------------------------|----------------------|--------------------------------|
| CPH3362-TL-W | CPH3, SC-59 SOT-23, TO-236 | 3,000 pcs. / reel | Pb-Free and Halogen Free |

Packing Type:TL

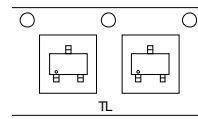

Marking

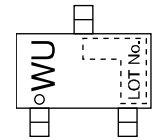

Electrical Connection

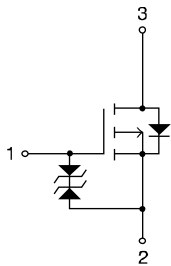

Switching Time Test Circuit

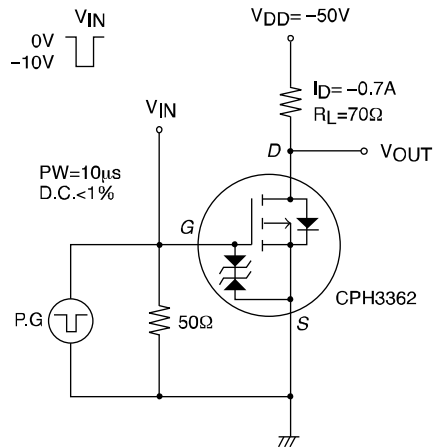

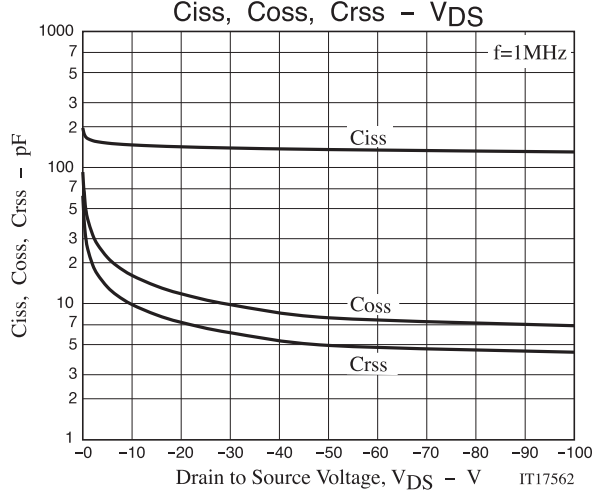
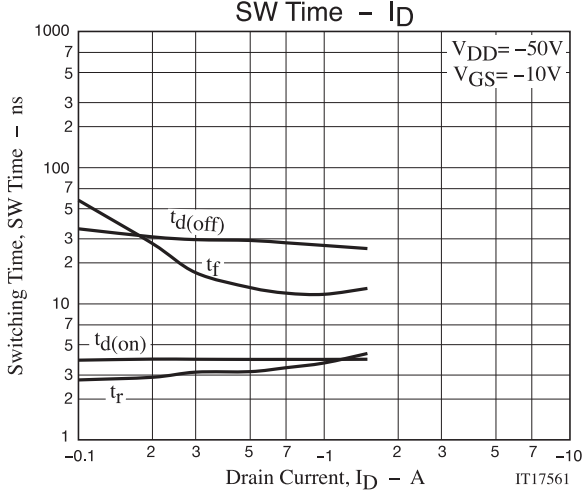
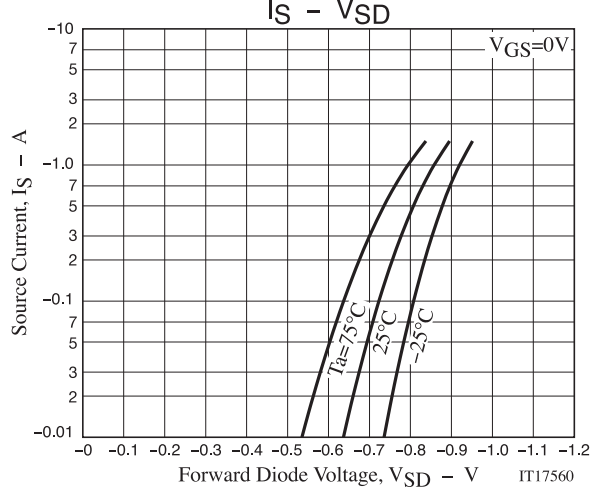
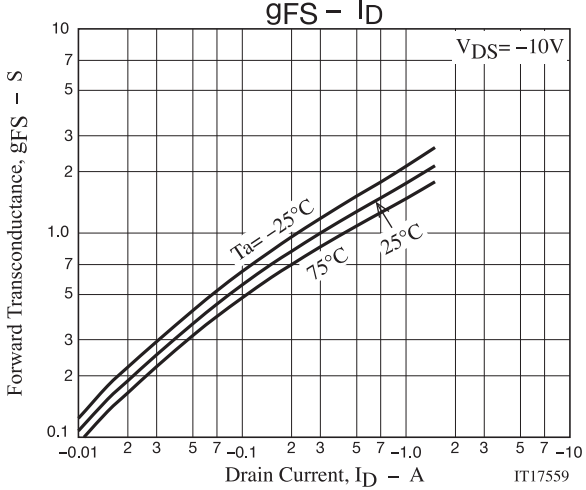
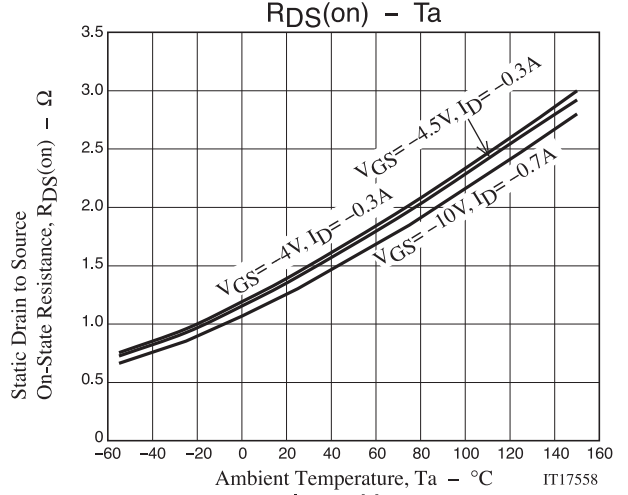
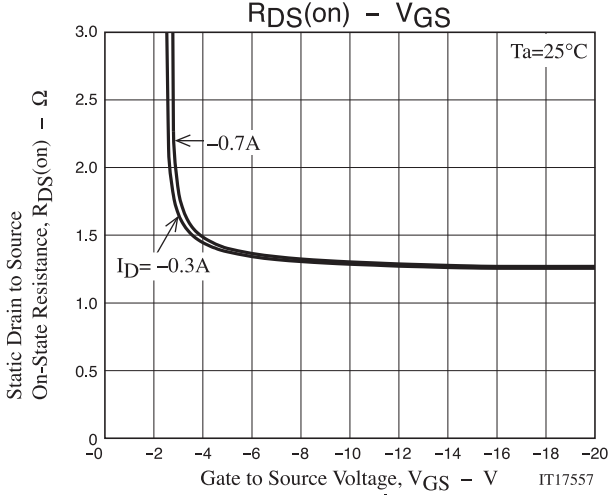
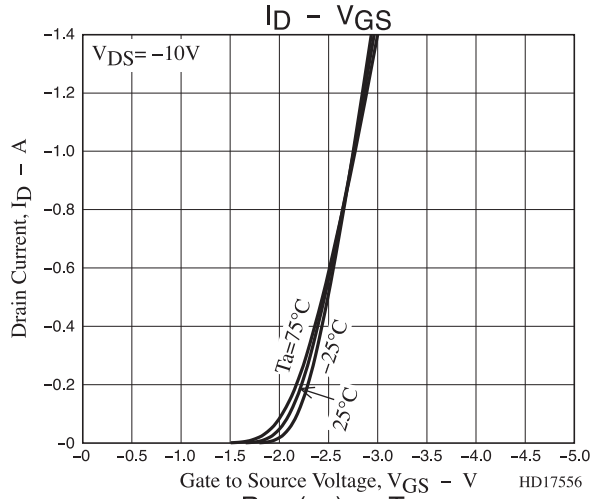
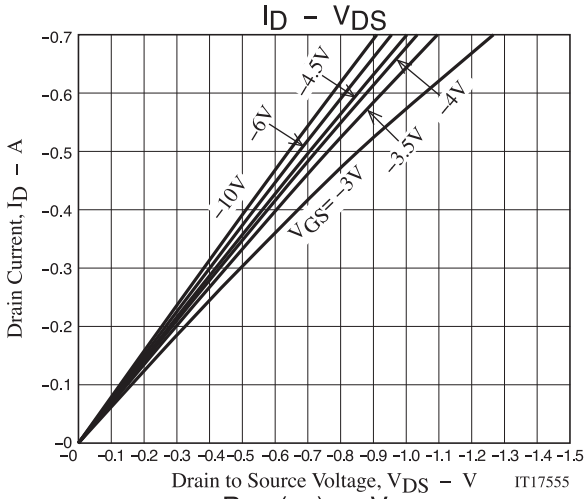

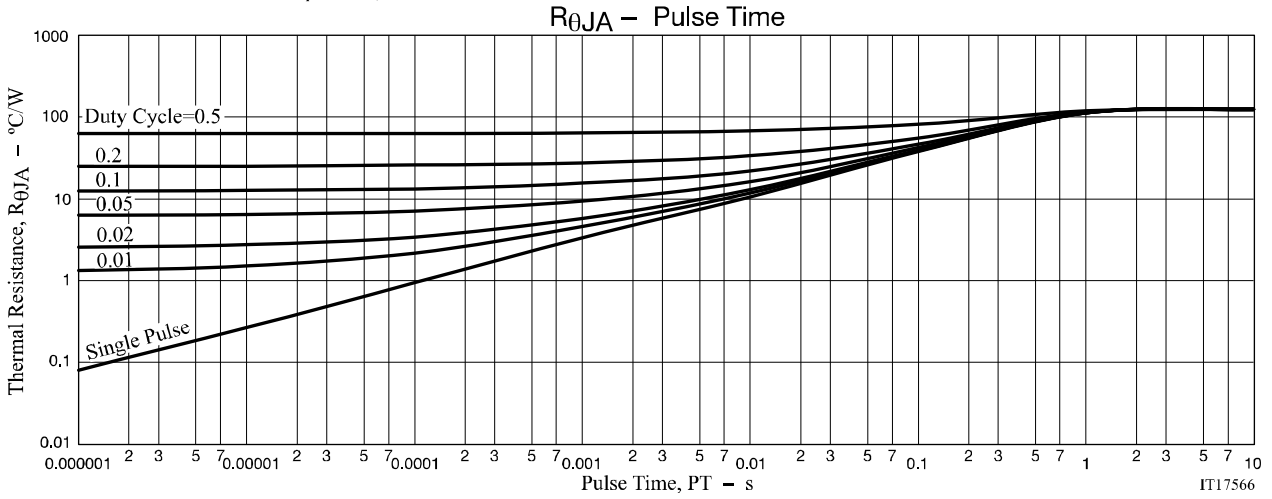
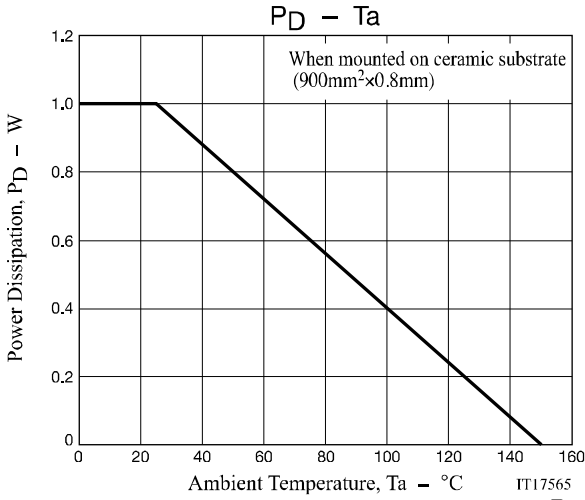
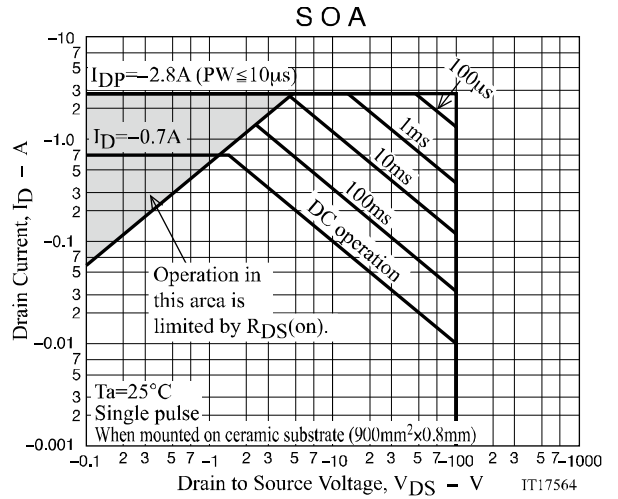
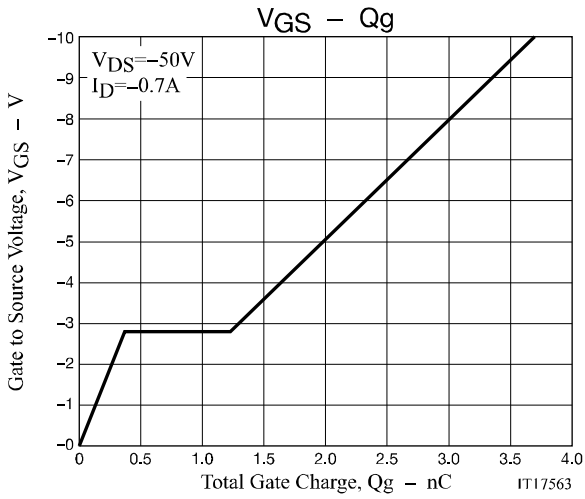

CPH3362

Package Dimensions

CPH3362-TL-W

CPH3

CASE 318BA

ISSUE O

unit : mm

1: Gate

2: Source

3: Drain

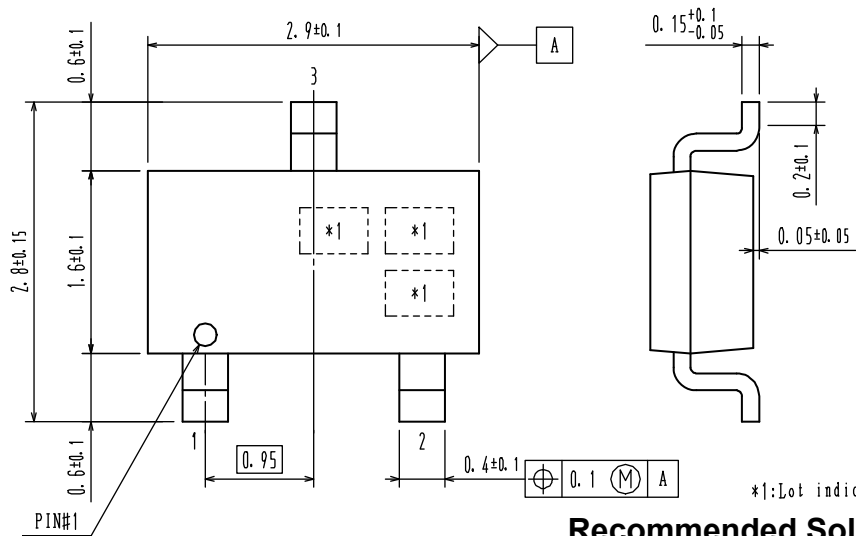

*1: Lot indication

Recommended Soldering Footprint

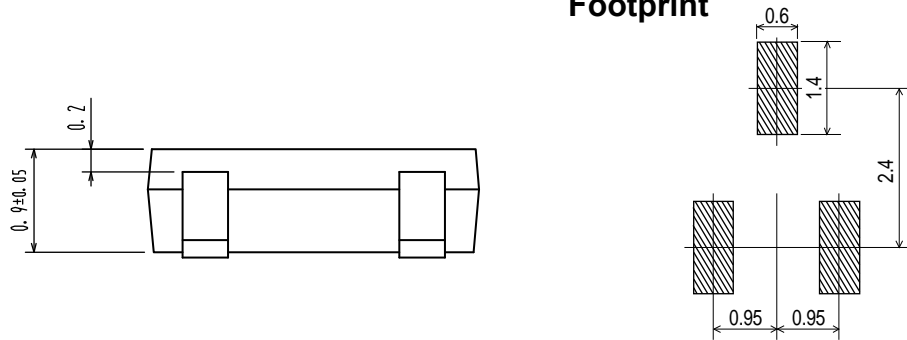

Note on usage : Since the CPH3362 is a MOSFET product, please avoid using this device in the vicinity of highly charged objects.

ON Semiconductor and the ON logo are registered trademarks of Semiconductor Components Industries, LLC (SCILLC) or its subsidiaries in the United States and/or other countries. SCILLC owns the rights to a number of patents, trademarks, copyrights, trade secrets, and other intellectual property. A listing of SCILLC's product/patent coverage may be accessed at www.onsemi.com/site/pdf/Patent-Marking.pdf. SCILLC reserves the right to make changes without further notice to any products herein. SCILLC makes no warranty, representation or guarantee regarding the suitability of its products for any particular purpose, nor does SCILLC assume any liability arising out of the application or use of any product or circuit, and specifically disclaims any and all liability, including without limitation special, consequential or incidental damages. "Typical" parameters which may be provided in SCILLC data sheets and/or specifications can and do vary in different applications and actual performance may vary over time. All operating parameters, including "Typicals" must be validated for each customer application by customer's technical experts. SCILLC does not convey any license under its patent rights nor the rights of others. SCILLC products are not designed, intended, or authorized for use as components in systems intended for surgical implant into the body, or other applications intended to support or sustain life, or for any other application in which the failure of the SCILLC product could create a situation where personal injury or death may occur. Should Buyer purchase or use SCILLC products for any such unintended or unauthorized application, Buyer shall indemnify and hold SCILLC and its officers, employees, subsidiaries, affiliates, and distributors harmless against all claims, costs, damages, and expenses, and reasonable attorney fees arising out of, directly or indirectly, any claim of personal injury or death associated with such unintended or unauthorized use, even if such claim alleges that SCILLC was negligent regarding the design or manufacture of the part. SCILLC is an Equal Opportunity/Affirmative Action Employer. This literature is subject to all applicable copyright laws and is not for resale in any manner.



Компания «ЭлектроПласт» предлагает заключение долгосрочных отношений при поставках импортных электронных компонентов на взаимовыгодных условиях!

Наши преимущества:

- Оперативные поставки широкого спектра электронных компонентов отечественного и импортного производства напрямую от производителей и с крупнейших мировых складов;
- Поставка более 17-ти миллионов наименований электронных компонентов;
- Поставка сложных, дефицитных, либо снятых с производства позиций;
- Оперативные сроки поставки под заказ (от 5 рабочих дней);
- Экспресс доставка в любую точку России;
- Техническая поддержка проекта, помощь в подборе аналогов, поставка прототипов;
- Система менеджмента качества сертифицирована по Международному стандарту ISO 9001;
- Лицензия ФСБ на осуществление работ с использованием сведений, составляющих государственную тайну;
- Поставка специализированных компонентов (Xilinx, Altera, Analog Devices, Intersil, Interpoint, Microsemi, Aeroflex, Peregrine, Syfer, Eurofarad, Texas Instrument, Miteq, Cobham, E2V, MA-COM, Hittite, Mini-Circuits, General Dynamics и др.);

Помимо этого, одним из направлений компании «ЭлектроПласт» является направление «Источники питания». Мы предлагаем Вам помощь Конструкторского отдела:

- Подбор оптимального решения, техническое обоснование при выборе компонента;
- Подбор аналогов;
- Консультации по применению компонента;
- Поставка образцов и прототипов;
- Техническая поддержка проекта;
- Защита от снятия компонента с производства.



Как с нами связаться

Телефон: 8 (812) 309 58 32 (многоканальный)

Факс: 8 (812) 320-02-42

Электронная почта: org@eplast1.ru

Адрес: 198099, г. Санкт-Петербург, ул. Калинина, дом 2, корпус 4, литера А.