

4S1 & 4SS-Series

Sub-Miniature &
Sealed Sub-Miniature
Slide Switches

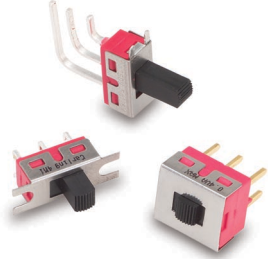

4M1-Series

Miniature Slide Switch

Specifications

Contact Rating refer to ordering scheme
 Electrical Life 30,000 make & break cycles at full load
 Contact Resistance. 10 mΩ max. initial @ 2-4 VDC
 100mA for both silver & gold plated contacts.
 Insulation Resistance . . . 1000 MΩ min.
 Dielectric Strength 1500 Volts RMS @ sea level
 Operating Temperature . . . -30°C to +85°C
 Solder Heat Resistance. . . MIL-STD-202, Method 210
 Actuator Travel 25°

Materials

Case Diallyl phthalate (DAP) (UL 94V-0)
 Slide Handle. Nylon
 Housing. Stainless Steel
 Terminal Seal Epoxy

4S1-Series Ordering Scheme



1 SERIES 4S1 Sub-Miniature Slide Switch																
2 POLES FSP single pole																
3 CIRCUIT <table style="width: 100%; border-collapse: collapse;"> <tr> <td colspan="4" style="text-align: center;">Switching Position:</td> </tr> <tr> <td style="width: 10%;"></td> <td style="width: 15%;">2-1</td> <td style="width: 20%;">OPEN</td> <td style="width: 15%;">2-3</td> </tr> <tr> <td style="text-align: center;">1</td> <td>ON</td> <td>NONE</td> <td>ON</td> </tr> <tr> <td style="text-align: center;">3</td> <td>ON</td> <td>OFF</td> <td>ON</td> </tr> </table>	Switching Position:					2-1	OPEN	2-3	1	ON	NONE	ON	3	ON	OFF	ON
Switching Position:																
	2-1	OPEN	2-3													
1	ON	NONE	ON													
3	ON	OFF	ON													
4 TERMINATION M2 PCB M6 PC Mount, 90° horizontal																

5 CONTACT		
Material	Terminal Plating	Rating
G silver ¹	gold over silver ³	3A@125VAC or 28VDC; 1.5A @ 250VAC
K gold ²	tin-lead ⁴	0.4VA max. @20V max (AC/DC)
P silver ¹	tin-lead ⁴	3A@125VAC or 28VDC; 1.5A @ 250VAC
Q silver ¹	silver ¹	3A@125VAC or 28VDC; 1.5A @ 250VAC
R gold ²	gold ²	0.4VA max. @20V max (AC/DC)
NOTE: Tin-lead option available with PC type terminations only. 1 Moveable contact & terminals: copper alloy, silver plate 2 Moveable contact & terminals: copper alloy with gold plate over nickel plate 3 Terminals: silver plate with outer layer in gold plating		
6 EPOXY SEAL E epoxy seal		
7 PACKAGING Switches are bulk packed, unless T/R is specified at the end of the part number. T/R tape reel - 500 pieces per reel		

4SS-Series Ordering Scheme



1 SERIES 4SS Sealed Sub-Miniature Slide Switch															
2 POLES FSP single pole															
3 CIRCUIT Switching Position: <table style="width: 100%; border-collapse: collapse;"> <tr> <td style="width: 10%;"></td> <td style="width: 10%;"></td> <td style="width: 10%; text-align: center;"><i>OPEN</i></td> <td style="width: 10%;"></td> <td style="width: 10%; text-align: center;"><i>2-3</i></td> </tr> <tr> <td style="text-align: center;">1</td> <td style="text-align: center;">ON</td> <td style="text-align: center;">NONE</td> <td style="text-align: center;">ON</td> <td style="text-align: center;">ON</td> </tr> <tr> <td style="text-align: center;">3</td> <td style="text-align: center;">ON</td> <td style="text-align: center;">OFF</td> <td style="text-align: center;">ON</td> <td style="text-align: center;">ON</td> </tr> </table>			<i>OPEN</i>		<i>2-3</i>	1	ON	NONE	ON	ON	3	ON	OFF	ON	ON
		<i>OPEN</i>		<i>2-3</i>											
1	ON	NONE	ON	ON											
3	ON	OFF	ON	ON											
4 TERMINATION Termination options for switches with brick color actuators M2 PCB M6 PC Mount, 90° horizontal M7 PC Mount, 90° vertical Termination options for switches with white color actuators L6 Surface Mount, 90° flat S6 Surface Mount, 90° horizontal S7 Surface Mount, 90° vertical															

5 CONTACT		
G silver ¹	Terminal Plating gold over silver	Rating 3A@125VAC or 28VDC; 1.5A @ 250VAC
K gold ²	tin-lead ⁴	0.4VA max. @20V max (AC/DC)
P silver ¹	tin-lead	3A@125VAC or 28VDC; 1.5A @ 250VAC
R gold ²	gold ²	0.4VA max. @20V max (AC/DC)
NOTE: Tin-lead option available with PC type terminations only.		
1 Moveable contact & terminals: copper alloy, silver plate		
2 Moveable contact & terminals: copper alloy with gold plate over nickel plate		
3 Terminals: silver plate with outer layer in gold plating		
4 Outer terminals: copper alloy with tin-lead over nickel plate		

6 EPOXY SEAL
E epoxy seal

7 PACKAGING
Switches are bulk packed, unless T/R is specified at the end of the part number. T/R tape reel - 500 pieces per reel

4M1-Series Ordering Scheme

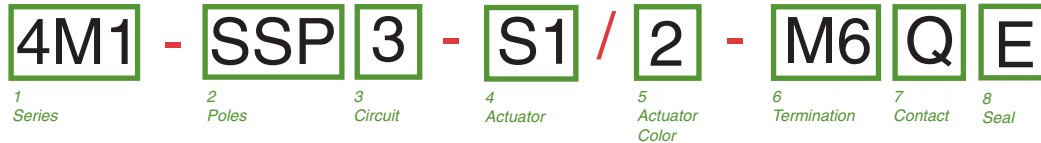

1 SERIES 4M1 Miniature Slide Switch															
2 POLES SSP single pole SDP double pole															
3 CIRCUIT Switching Position <table style="width: 100%; border-collapse: collapse;"> <tr> <td style="width: 10%;"></td> <td style="width: 10%; text-align: center;"><i>2-1, 5-4</i></td> <td style="width: 10%; text-align: center;"><i>OPEN</i></td> <td style="width: 10%;"></td> <td style="width: 10%; text-align: center;"><i>2-3, 5-6</i></td> </tr> <tr> <td style="text-align: center;">1</td> <td style="text-align: center;">ON</td> <td style="text-align: center;">NONE</td> <td style="text-align: center;">ON</td> <td style="text-align: center;">ON</td> </tr> <tr> <td style="text-align: center;">3</td> <td style="text-align: center;">ON</td> <td style="text-align: center;">OFF</td> <td style="text-align: center;">ON</td> <td style="text-align: center;">ON</td> </tr> </table>		<i>2-1, 5-4</i>	<i>OPEN</i>		<i>2-3, 5-6</i>	1	ON	NONE	ON	ON	3	ON	OFF	ON	ON
	<i>2-1, 5-4</i>	<i>OPEN</i>		<i>2-3, 5-6</i>											
1	ON	NONE	ON	ON											
3	ON	OFF	ON	ON											
4 ACTUATOR S1 .201 [5.10] high S2 .285 [7.25] high S3 .370 [9.40] high S4 .140 [3.55] high S5 .053 [1.35] high (for DPDT only) S6 .482 [12.25] high S7 .311 [7.90] high T1 .201 [5.10] high (for DPDT only)															
5 ACTUATOR COLOR¹ <table style="width: 100%; border-collapse: collapse;"> <tr> <td style="width: 15%;">1 white</td> <td style="width: 15%;">3 red</td> <td style="width: 15%;">5 yellow</td> <td style="width: 15%;">7 blue</td> <td style="width: 15%;">9 gray</td> </tr> <tr> <td>2 black</td> <td>4 orange</td> <td>6 green</td> <td>8 brown</td> <td></td> </tr> </table> <p><small>1 White, black & red are standard. Other colors available for quantities of 5K or more.</small></p>	1 white	3 red	5 yellow	7 blue	9 gray	2 black	4 orange	6 green	8 brown						
1 white	3 red	5 yellow	7 blue	9 gray											
2 black	4 orange	6 green	8 brown												

6 TERMINATION	
M1 Solder Lug	M5-3 Wire Wrap [10.80]
M2 PCB	M5-4 Wire Wrap [26.97]
M3 Quick Connect	M6 PC Mount, 90° horizontal
M5-1 Wire Wrap .750 [19.05]	M7 PC Mount, 90° vertical
M5-2 Wire Wrap [24.48]	VS2 PC Mount, U bracket, .620 mounting x .460 high

7 CONTACT				
G silver ¹	Material silver ¹	Terminal Plating gold over silver ²	Rating 5A@125VAC or 28VDC; 2A @ 250VAC	Approvals UL, CSA
K gold ²	tin-lead ⁴	tin-lead ⁴	0.4VA max. @20V max (AC/DC)	
P silver ¹	tin-lead ⁴	tin-lead ⁴	5A@125VAC or 28VDC; 2A @ 250VAC	UL, CSA
Q silver ¹	silver ¹	silver ¹	5A@125VAC or 28VDC; 2A @ 250VAC	UL, CSA
R gold ²	gold ²	gold ²	0.4VA max. @20V max (AC/DC)	
NOTE: Tin-lead option available with PC type terminations only.				
1 Moveable contact & terminals: copper alloy, silver plate				
2 Moveable contact & terminals: copper alloy with gold plate over nickel plate				
3 Terminals: silver plate with outer layer in gold plating				
4 Outer terminals: copper alloy with tin-lead over nickel plate				

8 EPOXY SEAL
E epoxy seal

4S-Series Dimensional Specifications: in. [mm]

4S1-Series

TERMINATION

PC MOUNTING

M2

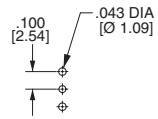
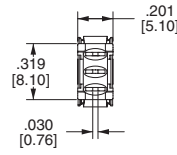
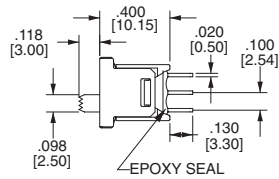
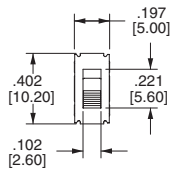

M6

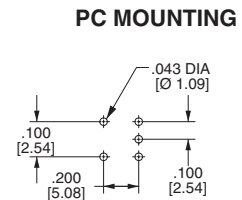
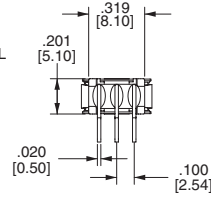
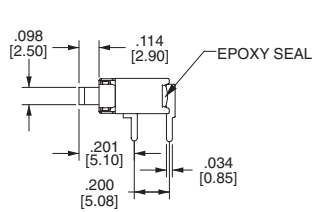
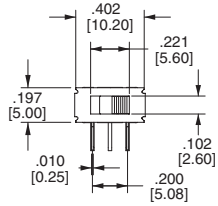

4SS-Series

TERMINATION

PC MOUNTING

M2

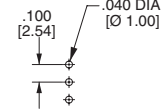
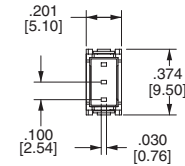
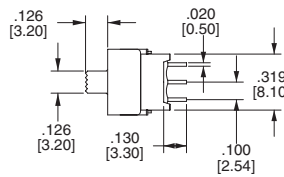
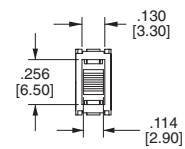

M6

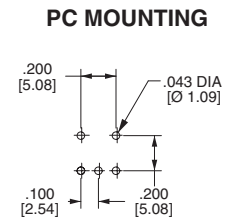
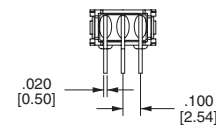
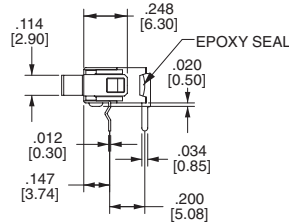
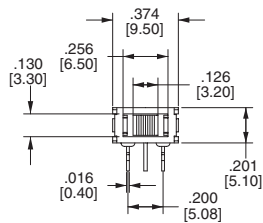

M7

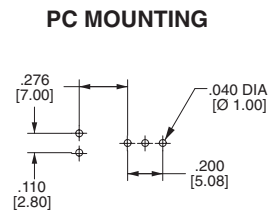
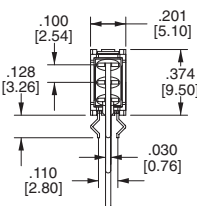
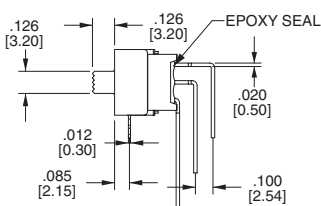
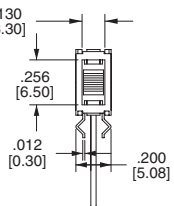

L6

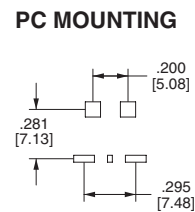
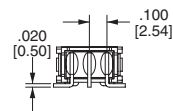
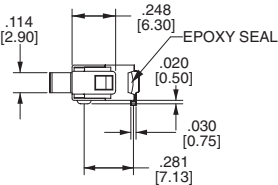
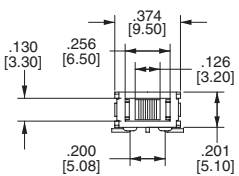

4SS-Series Dimensional Specifications: in. [mm]

TERMINATION

S6

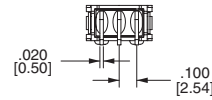
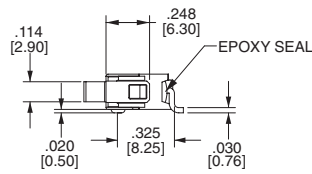
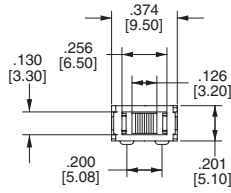

PC MOUNTING

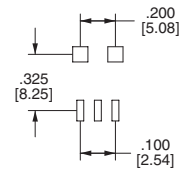

S7

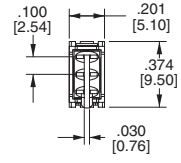
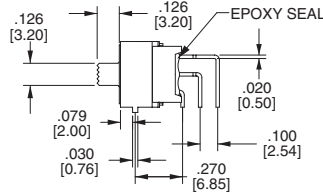
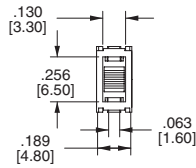

PC MOUNTING

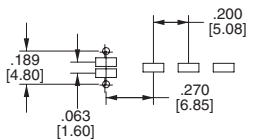

REEL TAPING

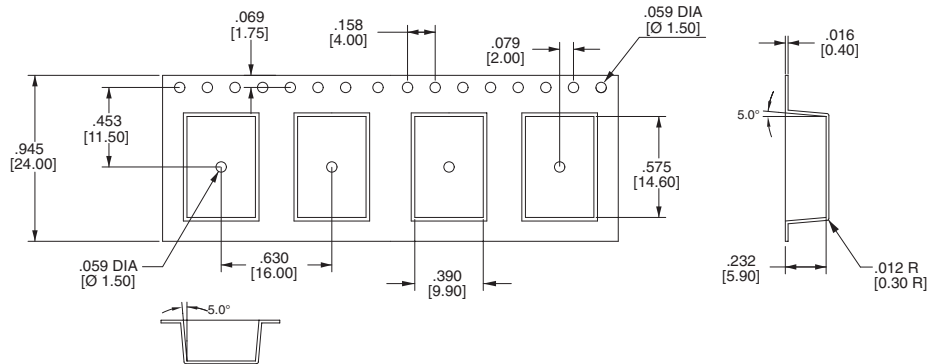

FOR S6, L6 ONLY

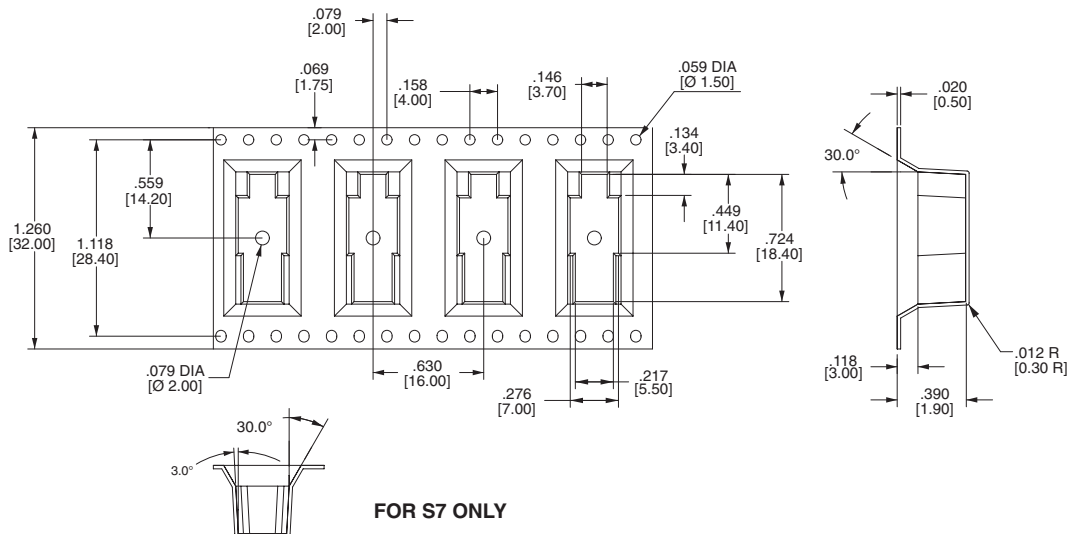

FOR S7 ONLY

4M1-Series Dimensional Specifications: in. [mm]

ACTUATOR

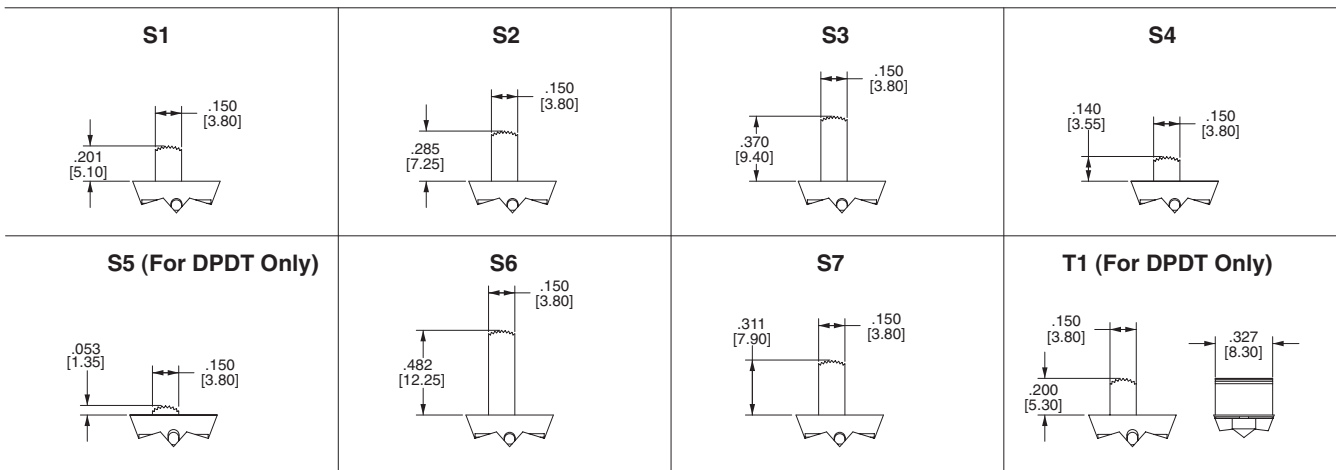

TERMINATION

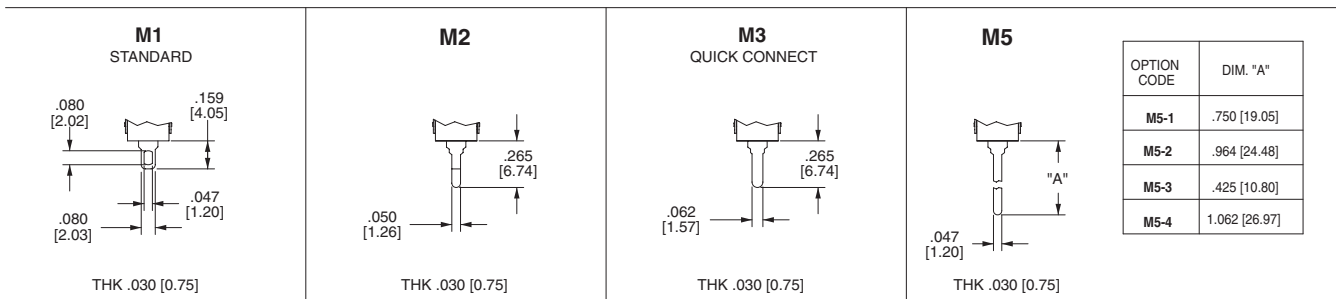

SINGLE POLE

DOUBLE POLE

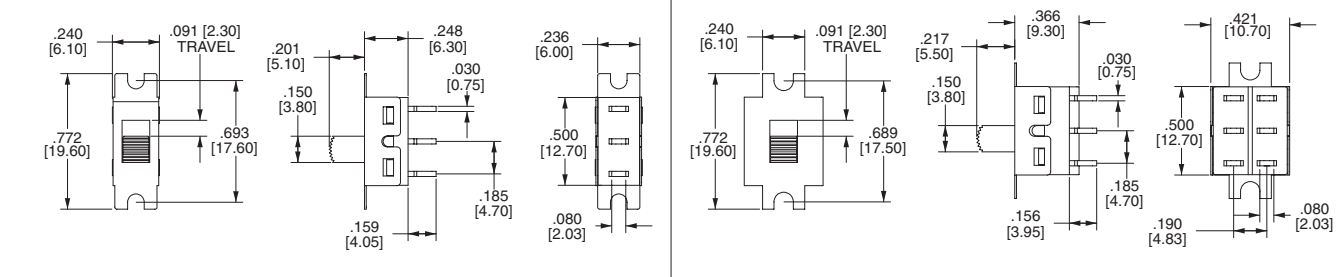

M6

SINGLE POLE

PC MOUNTING

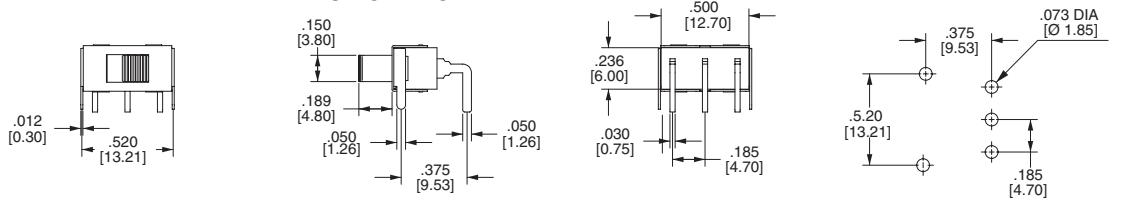

DOUBLE POLE

PC MOUNTING

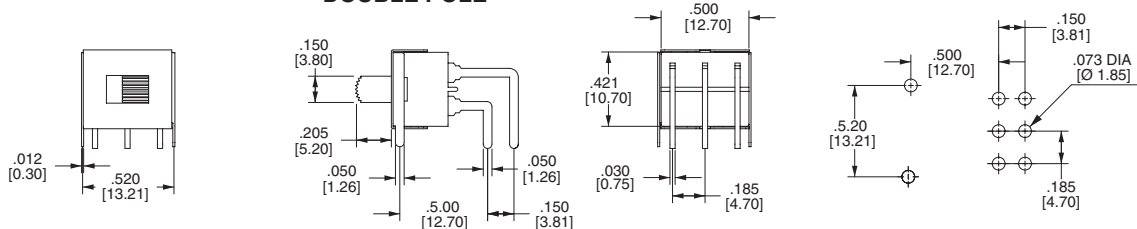

4M1-Series Dimensional Specifications: in. [mm]

TERMINATION

M7

SINGLE POLE

PC MOUNTING

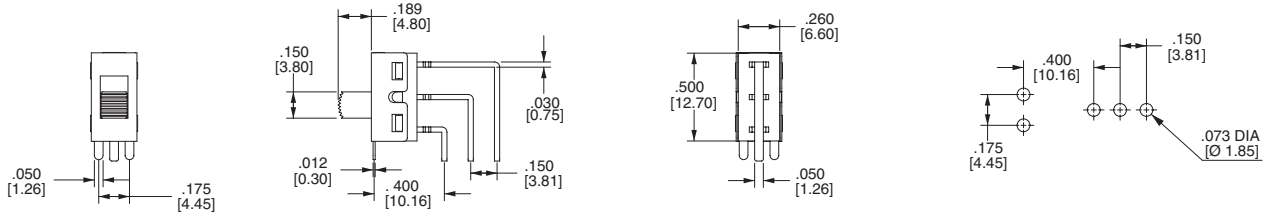

DOUBLE POLE

PC MOUNTING

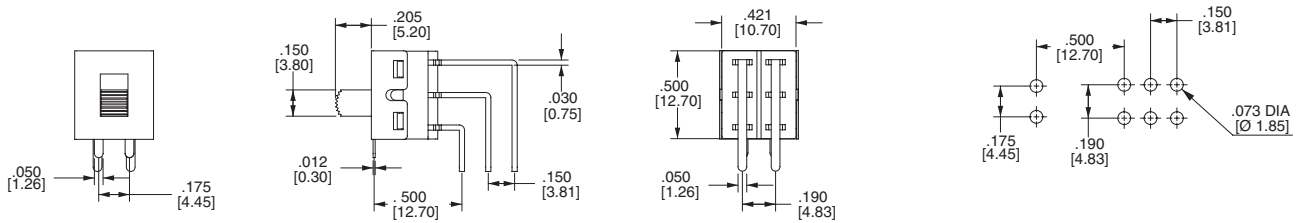

VS2

SINGLE POLE

PC MOUNTING

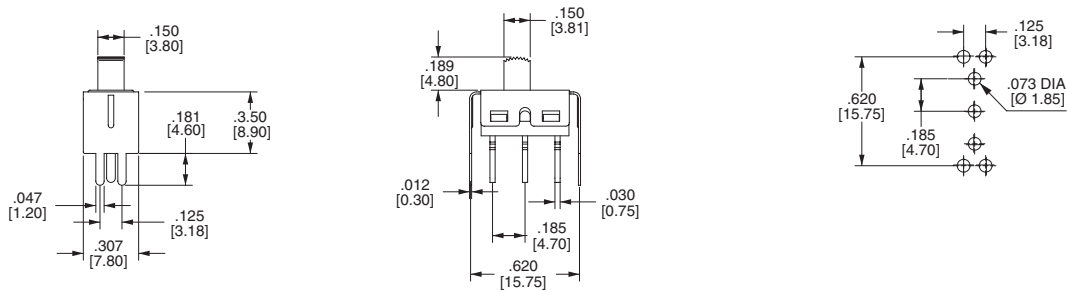

DOUBLE POLE

PC MOUNTING

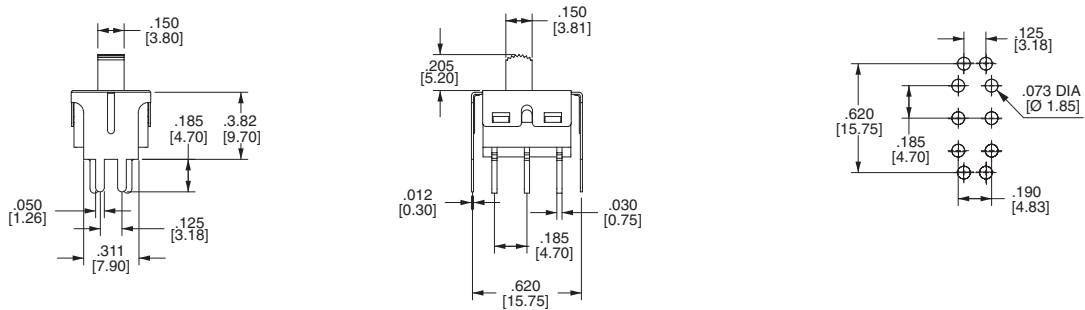



Компания «ЭлектроПласт» предлагает заключение долгосрочных отношений при поставках импортных электронных компонентов на взаимовыгодных условиях!

Наши преимущества:

- Оперативные поставки широкого спектра электронных компонентов отечественного и импортного производства напрямую от производителей и с крупнейших мировых складов;
- Поставка более 17-ти миллионов наименований электронных компонентов;
- Поставка сложных, дефицитных, либо снятых с производства позиций;
- Оперативные сроки поставки под заказ (от 5 рабочих дней);
- Экспресс доставка в любую точку России;
- Техническая поддержка проекта, помощь в подборе аналогов, поставка прототипов;
- Система менеджмента качества сертифицирована по Международному стандарту ISO 9001;
- Лицензия ФСБ на осуществление работ с использованием сведений, составляющих государственную тайну;
- Поставка специализированных компонентов (Xilinx, Altera, Analog Devices, Intersil, Interpoint, Microsemi, Aeroflex, Peregrine, Syfer, Eurofarad, Texas Instrument, Miteq, Cobham, E2V, MA-COM, Hittite, Mini-Circuits, General Dynamics и др.);

Помимо этого, одним из направлений компании «ЭлектроПласт» является направление «Источники питания». Мы предлагаем Вам помощь Конструкторского отдела:

- Подбор оптимального решения, техническое обоснование при выборе компонента;
- Подбор аналогов;
- Консультации по применению компонента;
- Поставка образцов и прототипов;
- Техническая поддержка проекта;
- Защита от снятия компонента с производства.



Как с нами связаться

Телефон: 8 (812) 309 58 32 (многоканальный)

Факс: 8 (812) 320-02-42

Электронная почта: org@eplast1.ru

Адрес: 198099, г. Санкт-Петербург, ул. Калинина, дом 2, корпус 4, литера А.