

DESCRIPTION

The MP6903 is a low-drop diode emulator that, combined with an external switch, replaces Schottky diodes in high-efficiency LLC converters. The chip regulates the forward drop of an external switch to about 70mV and switches it off as soon as the voltage goes negative. MP6903 has a light-load sleep mode that reduces the quiescent current to < 300µA.

FEATURES

- Works with Standard and Logic-Level FETS
- Compatible with Energy Star, 1W Standby Requirements
- V_{DD} Range from 8V to 24V
- 70mV V_{DS} Regulation Function ⁽¹⁾
- Fast Turn-Off: Total Delay of 20ns
- Max 400kHz Switching Frequency
- Light Load Mode Function ⁽¹⁾ with <300µA Quiescent Current
- Supports DCM, CCM and CrCM Operation
- Supports High-Side and Low-Side Rectification
- Power Savings of Up to 1.5W for a Typical Notebook Adapter

APPLICATIONS

- Industrial Power Systems
- Distributed Power Systems
- Battery Powered Systems
- LLC Converters

All MPS parts are lead-free and adhere to the RoHS directive. For MPS green status, please visit MPS website under Products, Quality Assurance page.

"MPS" and "The Future of Analog IC Technology" are Registered Trademarks of Monolithic Power Systems, Inc.

Notes:

- 1) Related issued patent: US Patent US8,067,973; US8,400,790. CN Patent ZL201010504140.4; ZL200910059751.X. Other patents pending.

TYPICAL APPLICATION

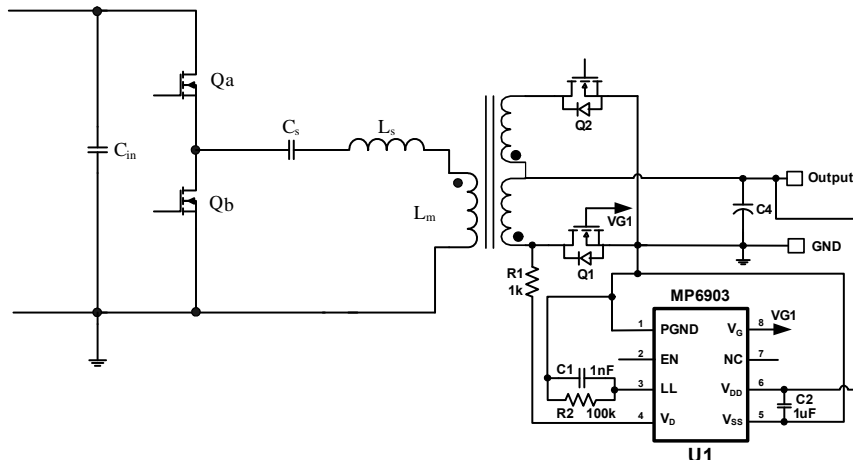

ORDERING INFORMATION

Part Number*	Package	Top Marking
MP6903DS	SOIC8	MP6903

* For Tape & Reel, add suffix -Z (e.g. MP6903DS-Z);
 For RoHS Compliant Packaging, add suffix -LF (e.g. MP6903DS-LF-Z)

PACKAGE REFERENCE

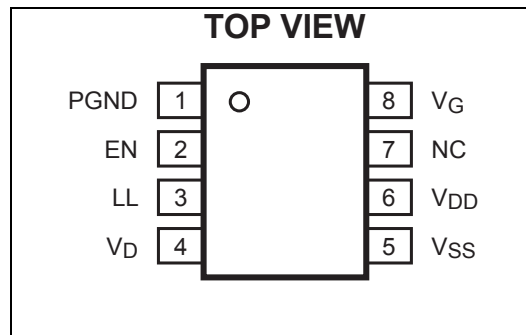

ABSOLUTE MAXIMUM RATINGS ⁽²⁾

V _{DD} to V _{SS}	-0.3V to +27V
PGND to V _{SS}	-0.3V to +0.3V
V _G to V _{SS}	-0.3V to V _{DD}
V _D to V _{SS}	-0.7V to +180V
LL, EN to V _{SS}	-0.3V to +6.5V
Maximum Operating Frequency.....	400kHz
Continuous Power Dissipation (T _A =25°C) ⁽³⁾	1.4W
Junction Temperature.....	150°C
Lead Temperature (Solder).....	260°C
Storage Temperature.....	-55°C to +150°C

Recommended Operation Conditions ⁽⁴⁾

V _{DD} to V _{SS}	8V to 24V
Operating Junction Temp. (T _J)....	-40°C to +125°C

Thermal Resistance ⁽⁵⁾

	θ_{JA}	θ_{JC}
SOIC8.....	90	45... °C/W

Notes:

- 2) Exceeding these ratings may damage the device.
- 3) The maximum allowable power dissipation is a function of the maximum junction temperature T_J(MAX), the junction-to-ambient thermal resistance θ_{JA} , and the ambient temperature T_A. The maximum allowable continuous power dissipation at any ambient temperature is calculated by P_D(MAX)=(T_J(MAX)-T_A)/ θ_{JA} . Exceeding the maximum allowable power dissipation will cause excessive die temperature, and the regulator will go into thermal shutdown. Internal thermal shutdown circuitry protects the device from permanent damage.
- 4) The device is not guaranteed to function outside of its operating conditions.
- 5) Measured on JESD51-7, 4-layer PCB.

ELECTRICAL CHARACTERISTICS

$V_{DD} = 12V$, $-40^{\circ}C \leq T_J \leq 125^{\circ}C$, unless otherwise noted.

Parameter	Symbol	Conditions	Min	Typ	Max	Units	
V_{DD} Voltage Range			8		24	V	
V_{DD} UVLO Rising			4.8	6.0	7.0	V	
V_{DD} UVLO hysteresis			0.8	1	1.2	V	
Operating Current	I_{CC}	$C_{LOAD}=5nF$, $f_{SW}=100kHz$		8	10	mA	
Quiescent Current	I_q	$V_{SS}-V_D=0.5V$		2	3	mA	
Shutdown Current		$V_{DD}=4V$		190	260	μA	
		$V_{DD}=20V$, $EN=0V$		350	420		
Light-Load Mode Current				290	400	μA	
Thermal Shutdown ⁽⁶⁾				180		$^{\circ}C$	
Thermal Shutdown Hysteresis ⁽⁶⁾				40		$^{\circ}C$	
Enable UVLO Rising			1.1	1.5	1.9	V	
Enable UVLO Hysteresis				0.2	0.4	V	
Internal Pull-up Current on EN Pin				10	15	μA	
CONTROL CIRCUITRY SECTION							
$V_{SS}-V_D$ Forward Voltage	V_{fwd}		55	70	85	mV	
Turn-on delay	t_{Don}	$C_{LOAD} = 5nF$	$-20^{\circ}C \leq T_J \leq 125^{\circ}C$		250	380	ns
			$-40^{\circ}C \leq T_J < -20^{\circ}C$		650		
	t_{Don}	$C_{LOAD} = 10nF$	$-20^{\circ}C \leq T_J \leq 125^{\circ}C$		400	680	ns
			$-40^{\circ}C \leq T_J < -20^{\circ}C$		1200		
Input Bias Current on V_D Pin		$V_D = 180V$		0.5	3	μA	
Minimum On-Time	t_{MIN}	$C_{LOAD} = 5nF$	0.4	0.8	1.2	μs	
Light-Load-Enter Delay	$t_{LL-Delay}$	$R_{LL}=100k\Omega$	80	120	150	μs	
Light-Load-Enter Pulse Width	t_{LL}	$R_{LL}=100k\Omega$	1.3	1.75	2.2	μs	
Light-Load-Enter Pulse Width Hysteresis	t_{LL-H}	$R_{LL}=100k\Omega$		0.2		μs	
Light-Load Resistor Value	R_{LL}		30		300	k Ω	
Light-Load Mode Exit Pulse Width Threshold (V_{DS})	V_{LL-DS}		-400	-250	-150	mV	
Light-Load Mode Enter Pulse Width Threshold (V_{GS}) ⁽⁶⁾	V_{LL-GS}			1.0		V	
GATE DRIVER SECTION							
V_G (Low)		$I_{LOAD}=1mA$		0.05	0.1	V	
V_G (High)		$V_{DD} > 17V$	13	14.5	16	V	
		$V_{DD} < 17V$	$V_{DD}-2.2$				
Turn Off Threshold ($V_{SS}-V_D$) ⁽⁶⁾				-30		mV	
Turn Off Threshold During Blanking Time ($V_{SS}-V_D$) ⁽⁶⁾				-100		mV	
Turn-Off Propagation Delay		$V_D=V_{SS}$		15		ns	
Turn-Off, Total Delay	t_{Doff}	$V_D = V_{SS}$, $C_{LOAD}=5nF$, $R_{GATE}=0\Omega$		60	120	ns	
	t_{Doff}	$V_D = V_{SS}$, $C_{LOAD}=10nF$, $R_{GATE}=0\Omega$		60	120	ns	
Pull Down Impedance				1	2	Ω	
Pull Down Current ⁽⁶⁾		$3V < V_G < 10V$		2		A	

Notes:

6) Guaranteed by Design and Characterization. Not tested in Production.

PIN FUNCTIONS

Pin #	Name	Description
1	PGND	Power Ground. Return for driver switch.
2	EN	Enable. Active high.
3	LL	Light Load Time Set. Connect a resistor to set the light load timing.
4	VD	MOSFET Drain Voltage Sense.
5	VSS	Ground. Also used as reference for VD.
6	VDD	Supply Voltage.
7	NC	No Connection.
8	VG	Gate Drive Output.

TYPICAL PERFORMANCE CHARACTERISTICS

$V_{DD} = 12V$, unless otherwise noted.

V_{FWD} vs. Temperature

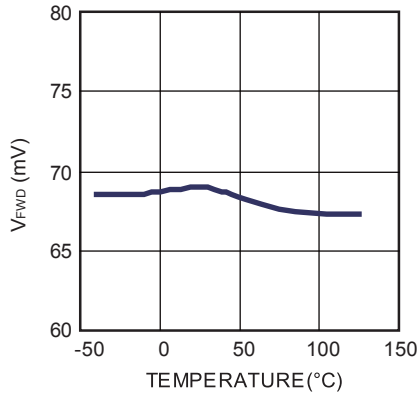

Turn off threshold vs. Temperature

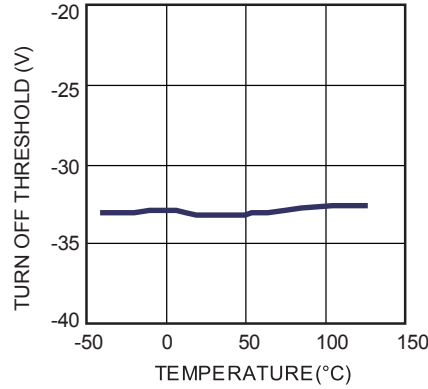

Quiescent Current vs. Temperature

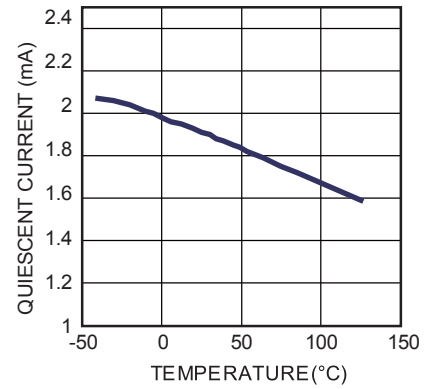

Shutdown Current vs. Temperature

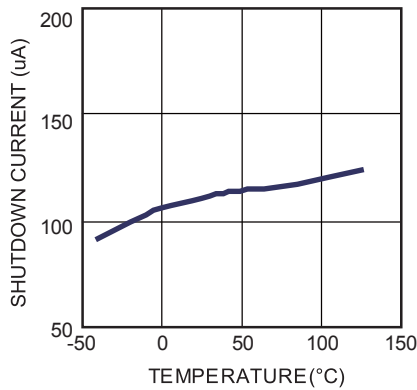

V_{DD} UVLO Rising vs. Temperature

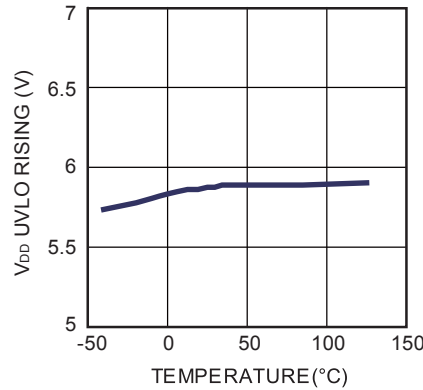

Operation Current vs. Temperature

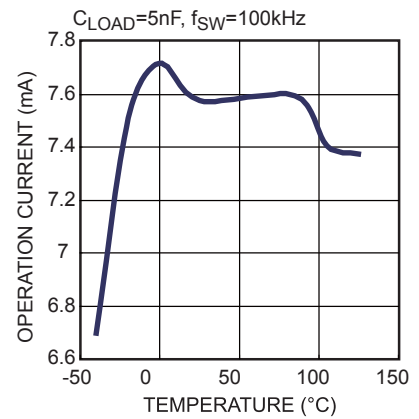

Light Load Mode Current vs. Temperature

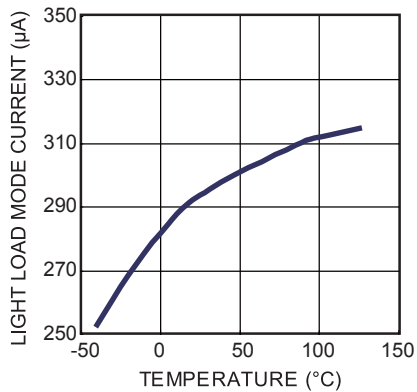

EN UVLO Rising vs. Temperature

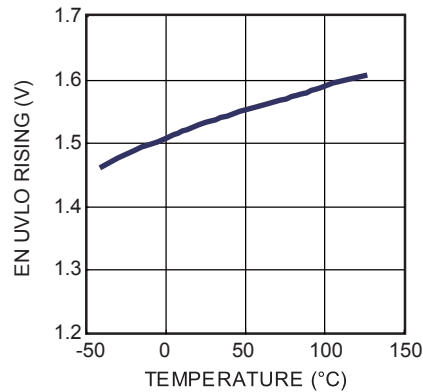

Turn On Delay vs. Temperature

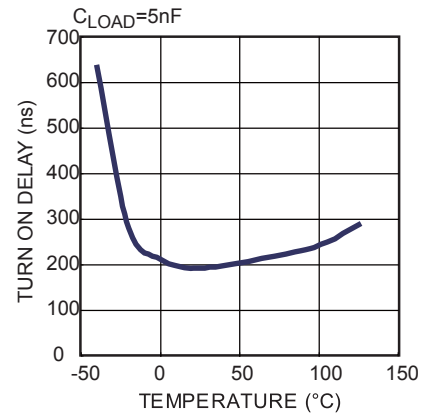

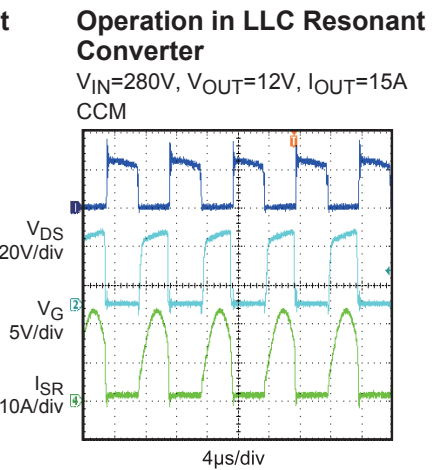
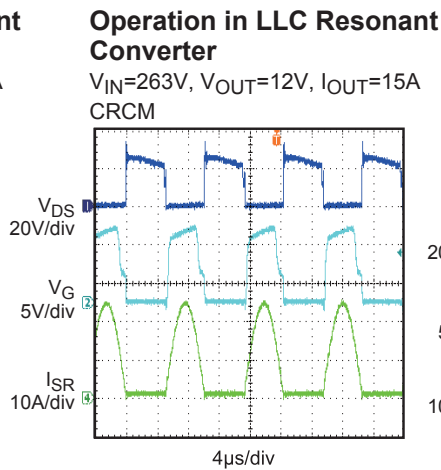
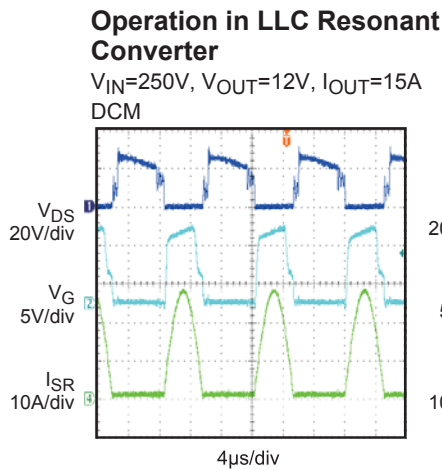
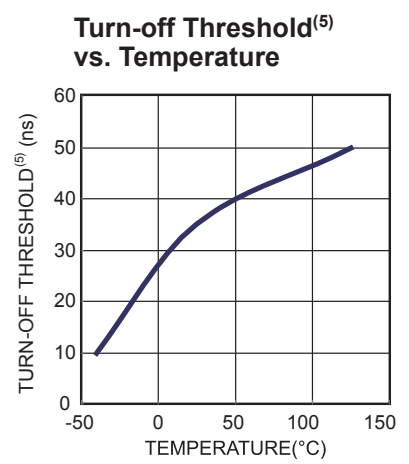
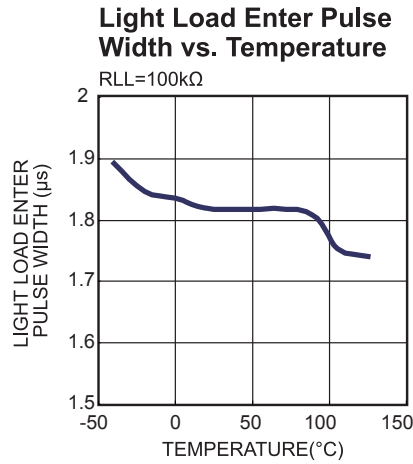
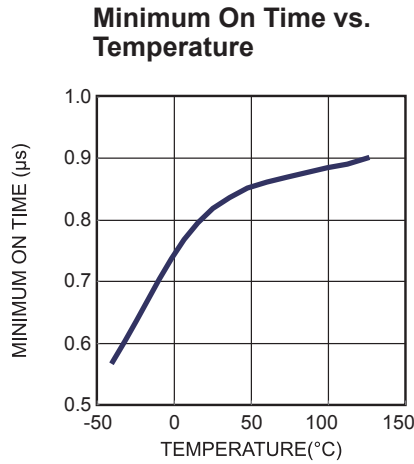
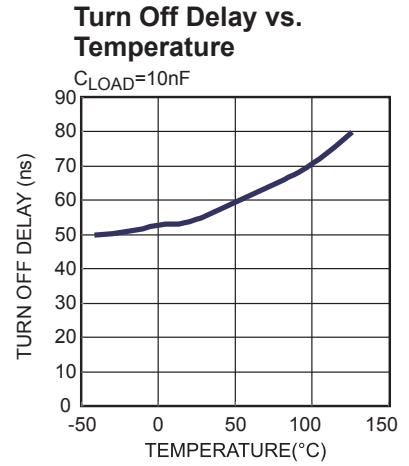
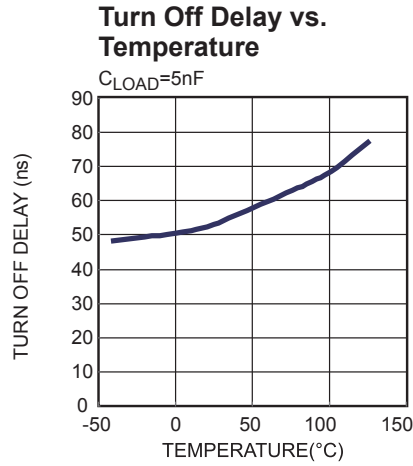
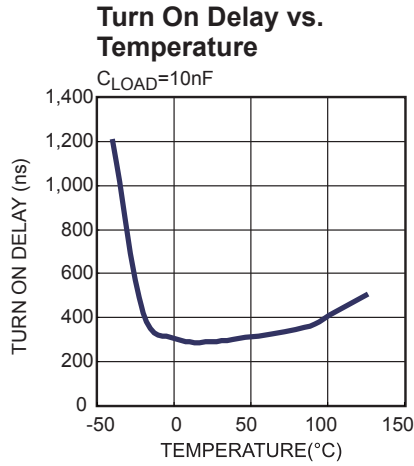
TYPICAL PERFORMANCE CHARACTERISTICS (continued)
 $V_{DD} = 12V$, unless otherwise noted.

FUNCTIONAL BLOCK DIAGRAM

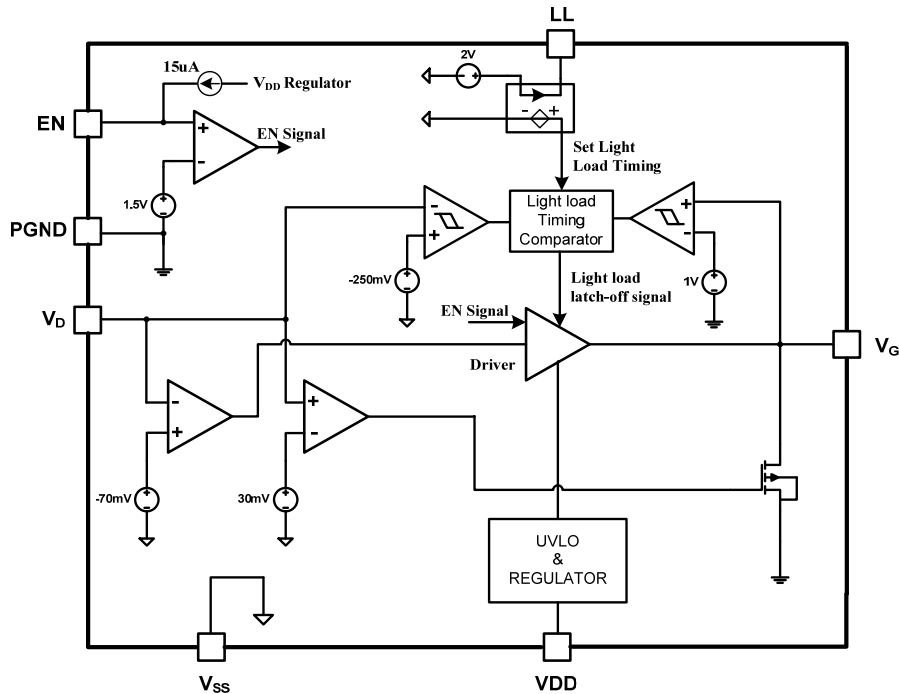

Figure 1: Functional Block Diagram

OPERATION

The MP6903 supports operation in discontinuous current mode (DCM), continuous current mode (CCM), and critical conduction mode (CrCM) condition. Operating in either a DCM or CrCM condition, the control circuitry controls the gate in forward mode and will turn the gate off when the MOSFET current goes low. In CCM operation, the control circuitry turns off the gate when very fast transients occur.

Blanking

The control circuitry contains a blanking function. When the MOSFET turns on or off, the blanking function ensures that the previous state extends for some minimum time period. The turn-on blanking time is $\sim 0.8\mu\text{s}$. During the turn-on blanking period, the turn-off threshold is not totally blanked, but changes the threshold voltage to approximately 100mV (instead of 30mV). This assures that the part can always turn off even during the turn-on blanking period. (The synchronous period is recommended to be greater than $0.8\mu\text{s}$ in CCM in the LLC Converter to avoid shoot-through.)

VD Clamp

A high-voltage JFET is used at the input because V_D can go as high as 180V. To avoid excessive currents when V_G goes below $-0.7V$, add a small resistor between V_D and the drain of the external MOSFET.

Under-Voltage Lockout (UVLO)

When V_{DD} drops below the UVLO threshold, the part goes into sleep mode and a $10k\Omega$ resistor pulls the V_G pin low.

Enable pin

EN is internal pulled up by the regulator from V_{DD} with a $\sim 15\mu\text{A}$ current source. Leave this pin open if unused.

When use external signal to control EN, it is highly recommended the pull down current be larger than $15\mu\text{A}$ to make sure the EN pin can be pulled to low.

Thermal shutdown

If the junction temperature of the chip exceeds 180°C, the VG will be pulled low and the part stops switching. The part will resume normal function after the junction temperature has dropped to 150°C.

Turn-On Phase

When the synchronous MOSFET is on, current flows through its body diode and generates a negative V_{DS} . This body diode voltage drop ($< -500mV$) is much smaller than the turn-on threshold of the control circuitry ($-70mV$), which then pulls the gate driver voltage high to turn on the synchronous MOSFET after about 250ns turn-on delay (shown in Figure 2).

When the turn-on delay ends, turn-on starts with a blanking time (minimum on-time: $\sim 0.8\mu s$), and the turn-off threshold changes from $+30mV$ to $+100mV$. This blanking time helps to avoid errors around the turn-off threshold caused by turn-on ringing of the synchronous MOSFET.

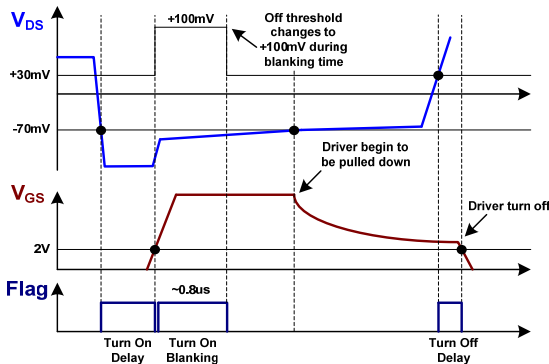

Figure 2: Turn On/Off Timing Diagram

Conducting Phase

When the synchronous MOSFET turns on, V_{DS} rises according to the MOSFET’s ON resistance. When V_{DS} rises above the turn-on threshold ($-70mV$), the control circuitry stops pulling up the gate driver, so the gate voltage is pulled down by the internal pull-down resistance ($10k\Omega$) and leakage to increase the ON resistance of the synchronous MOSFET, which to limit the V_{DS} slew rate, stabilizes V_{DS} to around $-70mV$ even when the current through the MOSFET is fairly small. This function limits the driver voltage when the synchronous MOSFET is turned off (this function is still active during turn-on blanking,

which means the gate driver could still be turned-off even with very small duty cycles of the synchronous MOSFET).

Turn-Off Phase

When V_{DS} triggers the turn-off threshold ($30mV$), the gate voltage is pulled to low after a 20ns turn-off delay (shown in Figure 2) by the control circuitry.

Figure 3 shows synchronous rectification operation at heavy load. The gate driver initially saturates due to the high current. After V_{DS} rises above $-70mV$, the gate driver voltage decreases to adjust the V_{DS} to around $-70mV$.

Figure 4 shows synchronous rectification operation at light load. The gate driver voltage never saturates due to the low current, but decreases as soon as the synchronous MOSFET turns on and adjusts the V_{DS} .

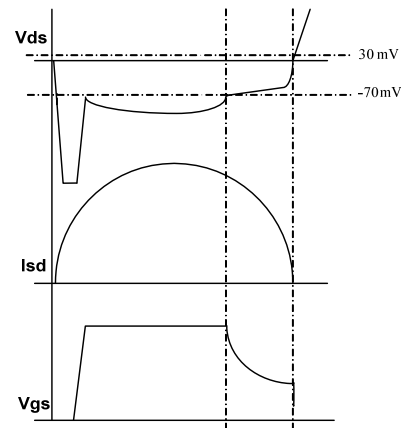

Figure 3: Synchronous Rectification Operation at Heavy Load

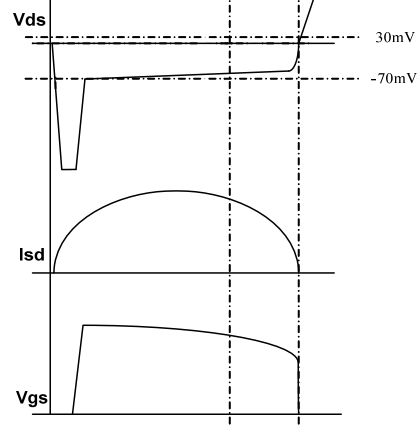

Figure 4: Synchronous Rectification Operation at Light Load

Light-Load Latch-Off Function

The gate driver of MP6903 is latched to save the driver loss at light-load condition to improve efficiency. See Figure5, when the synchronous MOSFET's conducting period keeps lower than light load timing (T_{LL}) for longer than the light-load-enter delay ($T_{LL-Delay}$), MP6903 enters light-load mode and latches off the gate driver. Here the synchronous MOSFET's conducting period is from turn on of the gate driver to the moment when V_{GS} drops to below 1V (V_{LL_GS}).

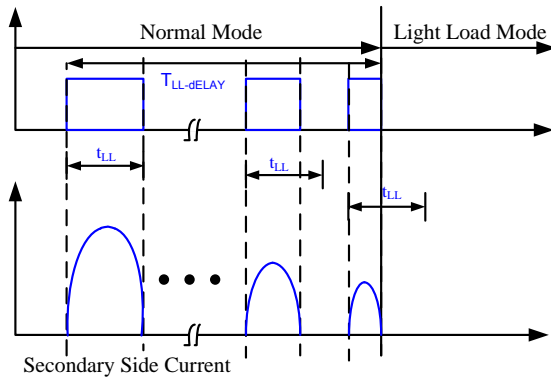

Figure 5: MP6903 Enters Light Load Mode

During light-load mode, MP6903 monitors the synchronous MOSFET's body diode conducting period by sensing the time duration of the V_{DS} below -250mV(V_{LL_DS}). If it is longer than $T_{LL}+T_{LL-H}$ (T_{LL-H} , light-load-enter pulse width hysteresis), the light-load mode is finished and gate driver of

MP6903 is unlatched to restart the synchronous rectification, see Figure6.

For MP6903, the light load enter timing (T_{LL}) is programmable by connecting a resistor (R_{LL}) on LL pin, by monitoring the LL pin current (the LL pin voltage keeps at ~2V internally), T_{LL} is set as following (a 1nF capacitor is recommended to decouple the noise on this pin):

$$T_{LL} \approx R_{LL} (k\Omega) \cdot \frac{2.2\mu s}{100k\Omega}$$

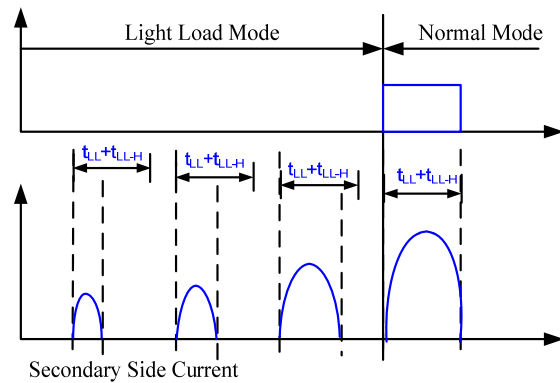
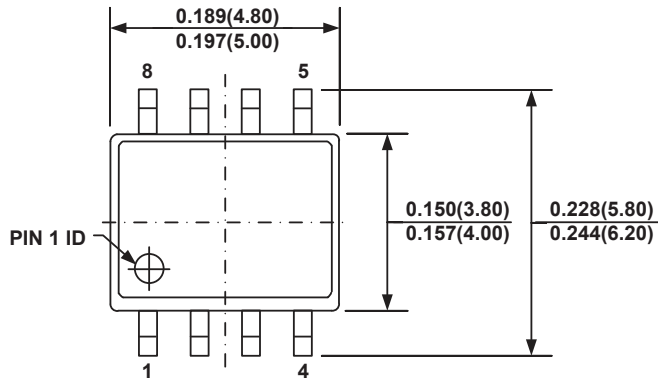
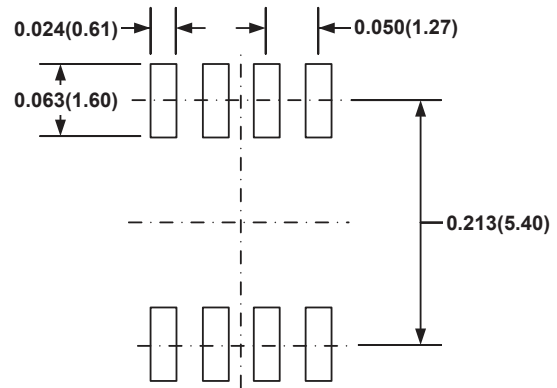
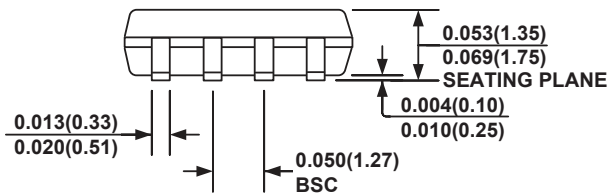
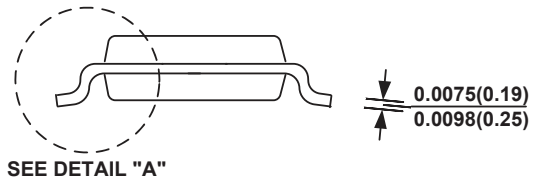
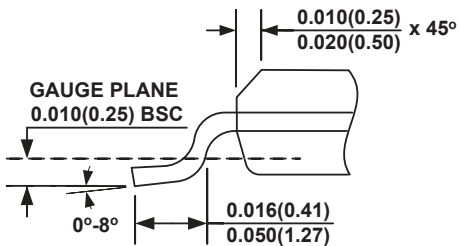

Figure 6: MP6903 Exits Light Load Mode

PACKAGE INFORMATION
SOIC8

TOP VIEW

RECOMMENDED LAND PATTERN

FRONT VIEW

SIDE VIEW

DETAIL "A"
NOTE:

- 1) CONTROL DIMENSION IS IN INCHES. DIMENSION IN BRACKET IS IN MILLIMETERS.
- 2) PACKAGE LENGTH DOES NOT INCLUDE MOLD FLASH, PROTRUSIONS OR GATE BURRS.
- 3) PACKAGE WIDTH DOES NOT INCLUDE INTERLEAD FLASH OR PROTRUSIONS.
- 4) LEAD COPLANARITY (BOTTOM OF LEADS AFTER FORMING) SHALL BE 0.004" INCHES MAX.
- 5) DRAWING CONFORMS TO JEDEC MS-012, VARIATION AA.
- 6) DRAWING IS NOT TO SCALE.

NOTICE: The information in this document is subject to change without notice. Users should warrant and guarantee that third party Intellectual Property rights are not infringed upon when integrating MPS products into any application. MPS will not assume any legal responsibility for any said applications.



Компания «ЭлектроПласт» предлагает заключение долгосрочных отношений при поставках импортных электронных компонентов на взаимовыгодных условиях!

Наши преимущества:

- Оперативные поставки широкого спектра электронных компонентов отечественного и импортного производства напрямую от производителей и с крупнейших мировых складов;
- Поставка более 17-ти миллионов наименований электронных компонентов;
- Поставка сложных, дефицитных, либо снятых с производства позиций;
- Оперативные сроки поставки под заказ (от 5 рабочих дней);
- Экспресс доставка в любую точку России;
- Техническая поддержка проекта, помощь в подборе аналогов, поставка прототипов;
- Система менеджмента качества сертифицирована по Международному стандарту ISO 9001;
- Лицензия ФСБ на осуществление работ с использованием сведений, составляющих государственную тайну;
- Поставка специализированных компонентов (Xilinx, Altera, Analog Devices, Intersil, Interpoint, Microsemi, Aeroflex, Peregrine, Syfer, Eurofarad, Texas Instrument, Miteq, Cobham, E2V, MA-COM, Hittite, Mini-Circuits, General Dynamics и др.);

Помимо этого, одним из направлений компании «ЭлектроПласт» является направление «Источники питания». Мы предлагаем Вам помощь Конструкторского отдела:

- Подбор оптимального решения, техническое обоснование при выборе компонента;
- Подбор аналогов;
- Консультации по применению компонента;
- Поставка образцов и прототипов;
- Техническая поддержка проекта;
- Защита от снятия компонента с производства.



Как с нами связаться

Телефон: 8 (812) 309 58 32 (многоканальный)

Факс: 8 (812) 320-02-42

Электронная почта: org@eplast1.ru

Адрес: 198099, г. Санкт-Петербург, ул. Калинина, дом 2, корпус 4, литера А.