

## AC and Pulse Metallized Polypropylene Film Capacitors MKP Axial Type

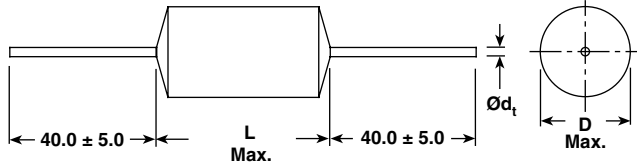

LEAD DIAMETER $d_t$ (mm)	D (mm)	L (mm)
$0.6 \pm 0.06$	$\leq 9.0$	$\leq 19.0$
$0.8 \pm 0.08$	$< 16.5$	$> 26.5$
$1.0 \pm 0.1$	$> 16.5$	$> 26.5$

**APPLICATIONS**

Pulse operations, SMPS and thyristor circuits, storage, filter, timing and sample and hold circuits.

**REFERENCE STANDARDS**

IEC 60384-16

**MARKING**

C-value; tolerance; rated voltage; manufacturer's type; code for dielectric material; manufacturer location; manufacturer's logo; year and week

**DIELECTRIC**

Polypropylene film

**ELECTRODES**

Metallized

**CONSTRUCTION**

Mono construction

**RATED (DC) VOLTAGE**

160 V, 250 V, 400 V, 630 V

**RATED (AC) VOLTAGE**

100 V, 160 V, 220 V, 250 V

**FEATURES**

Supplied loose in box, taped on ammpack or reel  
RoHS compliant



**ENCAPSULATION**

Plastic-wrapped, epoxy resin sealed. Flame retardant.



**RoHS**  
COMPLIANT

**CLIMATIC TESTING CLASS ACC. TO IEC 60068-1**

55/100/56

**CAPACITANCE RANGE (E12 SERIES)**

47 pF to 22  $\mu$ F

**CAPACITANCE TOLERANCE**

$\pm 10 \%$ ,  $\pm 5 \%$ ,  $\pm 2.5 \%$ ,  $\pm 2 \%$ ,  $\pm 1 \%$

**LEADS**

Tinned wire

**MAXIMUM APPLICATION TEMPERATURE**

100 °C

**PULL TEST ON LEADS**

$\geq 20$  N in direction of leads according to IEC 60068-2-21

**BENT TEST ON LEADS**

2 bends trough 90° with half of the force used in pull test

**DETAIL SPECIFICATION**

For more detailed data and test requirements contact:  
[dc-film@vishay.com](mailto:dc-film@vishay.com)



**COMPOSITION OF CATALOG NUMBER**

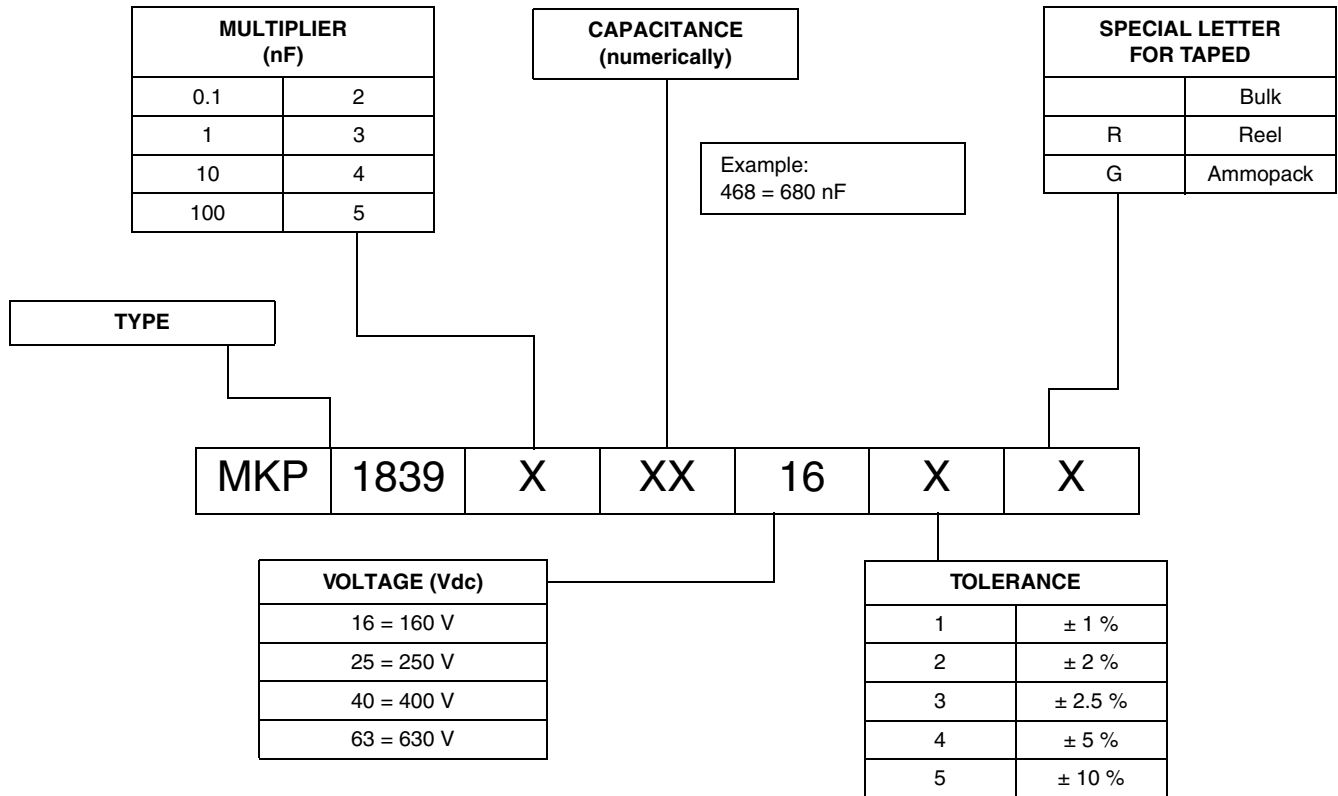

**Note**

(1) For detailed tape specifications refer to "Packaging Information": [www.vishay.com/doc?28139](http://www.vishay.com/doc?28139) or end of catalog

**SPECIFIC REFERENCE DATA**

DESCRIPTION	VALUE			
	at 1 kHz	at 10 kHz	at 100 kHz	
Tangent of loss angle:				
$C \leq 0.1 \mu\text{F}$	$4 \times 10^{-4}$	$6 \times 10^{-4}$	$40 \times 10^{-4}$	
$0.1 \mu\text{F} < C \leq 1.0 \mu\text{F}$	$4 \times 10^{-4}$	$6 \times 10^{-4}$	-	
$C > 1.0 \mu\text{F}$	$10 \times 10^{-4}$	-	-	
Capacitor length (mm)	Maximum pulse rise time (dU/dt) <sub>R</sub> [V/μs]			
	160 Vdc	250 Vdc	400 Vdc	630 Vdc
11	240	300	515	700
14	175	220	380	510
19	100	125	200	280
26.5	60	75	120	160
31.5	45	60	95	120
41.5	30	40	65	85
If the maximum pulse voltage is less than the rated voltage higher dU/dt values can be permitted.				
R between leads, for $C \leq 0.33 \mu\text{F}$ at 100 V, 1 min	> 100 000 MΩ			
RC between leads, for $C > 0.33 \mu\text{F}$ at 100 V, 1 min	> 30 000 s			
R between leads and case, 100 V, 1 min	> 30 000 MΩ			
Withstanding (DC) voltage between leads and wrapped film ( $1.4 \times U_{\text{Rac}} + 2000$ )	2840 V, 1 min			
Withstanding (DC) voltage (cut off current 10 mA), rise time 100 V/s	$1.6 \times U_{\text{Rdc}}$ , 1 min			
Maximum application temperature	100 °C			



CAPACITANCE	CAPACITANCE CODE	VOLTAGE CODE 16 160 Vdc/100Vac		VOLTAGE CODE 25 250 Vdc/160Vac		VOLTAGE CODE 40 400 Vdc/220Vac <sup>(1)</sup>		VOLTAGE CODE 63 630 Vdc/250Vac <sup>(1)</sup>	
		D (mm)	L (mm)	D (mm)	L (mm)	D (mm)	L (mm)	D (mm)	L (mm)
47 pF	047	-	-	-	-	-	-	5.0	11.0
51 pF	051	-	-	-	-	-	-	5.0	11.0
56 pF	056	-	-	-	-	-	-	5.0	11.0
62 pF	056	-	-	-	-	-	-	5.0	11.0
68 pF	068	-	-	-	-	-	-	5.5	11.0
75 pF	075	-	-	-	-	-	-	5.5	11.0
82 pF	082	-	-	-	-	-	-	5.5	11.0
91 pF	091	-	-	-	-	-	-	6.0	11.0
100 pF	110	-	-	-	-	-	-	6.0	11.0
110 pF	111	-	-	-	-	-	-	6.0	11.0
120 pF	112	-	-	-	-	-	-	6.0	11.0
130 pF	113	-	-	-	-	-	-	6.0	11.0
150 pF	115	-	-	-	-	-	-	6.0	11.0
160 pF	116	-	-	-	-	-	-	6.0	11.0
180 pF	118	-	-	-	-	-	-	6.0	11.0
200 pF	120	-	-	-	-	-	-	6.0	11.0
220 pF	122	-	-	-	-	-	-	5.0	11.0
240 pF	124	-	-	-	-	-	-	5.0	11.0
270 pF	127	-	-	-	-	-	-	5.0	11.0
300 pF	130	-	-	-	-	-	-	5.0	11.0
330 pF	133	-	-	-	-	-	-	5.0	11.0
360 pF	136	-	-	-	-	-	-	5.0	11.0
390 pF	139	-	-	-	-	-	-	5.0	11.0
430 pF	143	-	-	-	-	-	-	5.0	11.0
470 pF	147	-	-	-	-	-	-	5.0	11.0
510 pF	151	-	-	-	-	-	-	5.0	11.0
560 pF	156	-	-	-	-	-	-	5.5	11.0
620 pF	162	-	-	-	-	-	-	5.5	11.0
680 pF	168	-	-	-	-	-	-	5.5	11.0
750 pF	175	-	-	-	-	-	-	5.5	11.0
820 pF	182	-	-	-	-	-	-	5.0	11.0
910 pF	191	-	-	-	-	-	-	5.0	11.0
1000 pF	210	-	-	-	-	-	-	5.0	11.0
1100 pF	211	-	-	-	-	-	-	5.0	11.0
1200 pF	212	-	-	-	-	-	-	5.0	11.0
1300 pF	213	-	-	-	-	-	-	5.0	11.0
1500 pF	215	-	-	-	-	-	-	5.0	11.0
1600 pF	216	-	-	-	-	-	-	5.0	11.0
1800 pF	218	-	-	-	-	-	-	5.0	11.0
2000 pF	220	-	-	-	-	-	-	5.0	11.0
2200 pF	222	-	-	-	-	-	-	5.0	11.0
2400 pF	224	-	-	-	-	-	-	5.0	11.0
2700 pF	227	-	-	-	-	-	-	5.0	11.0
3000 pF	230	-	-	-	-	-	-	5.0	11.0
3300 pF	233	-	-	-	-	-	-	5.0	11.0
3600 pF	236	-	-	-	-	-	-	5.0	11.0
3900 pF	239	-	-	-	-	-	-	5.0	11.0
4300 pF	243	-	-	-	-	-	-	5.0	11.0
4700 pF	247	-	-	-	-	-	-	5.0	11.0
6200 pF	262	-	-	-	-	-	-	5.5	11.0
6800 pF	268	-	-	-	-	5.0	11.0	5.5	11.0



AC and Pulse Metallized Polypropylene Film Capacitors Vishay Roederstein  
MKP Axial Type

CAPACITANCE	CAPACITANCE CODE	VOLTAGE CODE 16 160 Vdc/100Vac		VOLTAGE CODE 25 250 Vdc/160Vac		VOLTAGE CODE 40 400 Vdc/220Vac <sup>(1)</sup>		VOLTAGE CODE 63 630 Vdc/250Vac <sup>(1)</sup>	
		D (mm)	L (mm)	D (mm)	L (mm)	D (mm)	L (mm)	D (mm)	L (mm)
8200 pF	282	-	-	-	-	5.0	11.0	6.0	11
0.01 µF	310	-	-	5.0	11.0	5.5	11.0	5.5	14.0
0.015 µF	315	-	-	5.0	11.0	6.0	11.0	6.5	14.0
0.022 µF	322	-	-	5.0	11.0	6.5	14.0	7.5	14.0
0.033 µF	333	5.0	11.0	5.5	11.0	7.0	14.0	7.0	19.0
0.047 µF	347	5.5	11.0	6.0	14.0	8.0	14.0	8.0	19.0
0.068 µF	368	6.0	11.0	6.5	14.0	8.5	19.0	9.0	19.0
0.1 µF	410	6.5	14.0	7.5	14.0	9.0	19.0	8.5	26.5
0.15 µF	415	7.5	14.0	7.0	19.0	8.0	26.5	10.5	26.5
0.22 µF	422	7.0	19.0	8.5	19.0	9.5	26.5	12.0	26.5
0.33 µF	433	8.0	19.0	8.0	26.5	11.5	26.5	14.5	26.5
0.47 µF	447	9.0	19.0	9.0	26.5	13.5	26.5	15.0	31.5
0.68 µF	468	8.5	26.5	11.0	26.5	14.0	31.5	18.0	31.5
1.0 µF	510	10.5	26.5	12.5	26.5	17.0	31.5	18.0	41.5
1.5 µF	515	12.0	26.5	13.0	31.5	20.5	31.5	22.0	41.5
2.2 µF	522	13.0	31.5	16.0	31.5	21.0	41.5	-	-
3.3 µF	533	15.5	31.5	19.0	31.5	-	-	-	-
4.7 µF	547	15.5	41.5	19.5	41.5	-	-	-	-
6.8 µF	568	18.5	41.5	23.0	41.5	-	-	-	-
10 µF	610	22.0	41.5	22.0	41.5	-	-	-	-
15 µF	615	24.5	41.5	24.5	41.5	-	-	-	-
22 µF	622	28.5	41.5	28.5	41.5	-	-	-	-

**Notes**

<sup>(1)</sup> Not suitable for mains applications

- Pitch = L + 3.5 mm

**RECOMMENDED PACKAGING**

PACKAGING CODE	TYPE OF PACKAGING	REEL DIAMETER (mm)	ORDERING CODE EXAMPLES	
G	Ammo	-	MKP 1839-422-403-G	x
R	Reel	350	MKP 1839-422-403-R	x
-	Bulk for L > 31.5 mm	-	MKP 1839-522-403	x

**Note**

- For detailed tape specifications refer to “Packaging Information”: [www.vishay.com/doc?28139](http://www.vishay.com/doc?28139)

**MOUNTING**

**Normal Use**

The capacitors are designed for mounting on printed-circuit boards. The capacitors packed in bandoliers are designed for mounting in printed-circuit boards by means of automatic insertion machines.

For detailed tape specifications refer to “Packaging Information”: [www.vishay.com/doc?28139](http://www.vishay.com/doc?28139)

**Specific Method of Mounting to Withstand Vibration and Shock**

In order to withstand vibration and shock tests, it must be ensured that the capacitors body is in good contact with the printed-circuit board.

- For L < 19 mm capacitors shall be mechanically fixed by the leads
- For larger pitches the capacitors shall be mounted in the same way and the body clamped
- The maximum diameter and length of the capacitors are specified in the dimensions table
- Eccentricity as shown in the drawing on next page

**Space Requirements on Printed-Circuit Board**

The maximum length and width of film capacitors is shown in drawing:

- Eccentricity as in drawing. The maximum eccentricity is smaller than or equal to the lead diameter of the product concerned.
- Product height with seating plane as given by IEC 60717 as reference:  $h_{max.} \leq h + 0.4 \text{ mm}$  or  $h_{max.} \leq h' + 0.4 \text{ mm}$

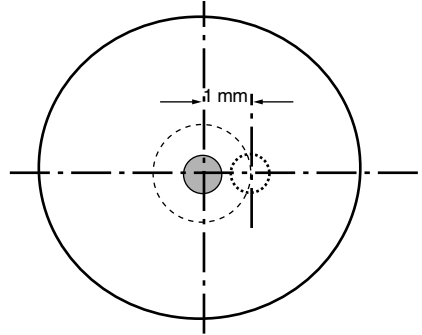

**Storage Temperature**

- Storage temperature:  $T_{stg} = -25 \text{ }^\circ\text{C}$  to  $+40 \text{ }^\circ\text{C}$  with RH maximum 80 % without condensation

**Ratings and Characteristics Reference Conditions**

Unless otherwise specified, all electrical values apply to an ambient temperature of  $23 \text{ }^\circ\text{C} \pm 1 \text{ }^\circ\text{C}$ , an atmospheric pressure of 86 kPa to 106 kPa and a relative humidity of  $50 \text{ } \% \pm 2 \text{ } \%$ .

For reference testing, a conditioning period shall be applied over  $96 \text{ h} \pm 4 \text{ h}$  by heating the products in a circulating air oven at the rated temperature and a relative humidity not exceeding 20 %.

**CHARACTERISTICS**

Max. RMS voltage as a function of frequency (typical curve)

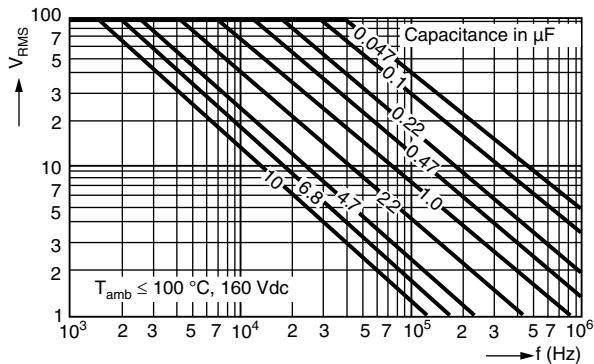

Max. RMS voltage as a function of frequency

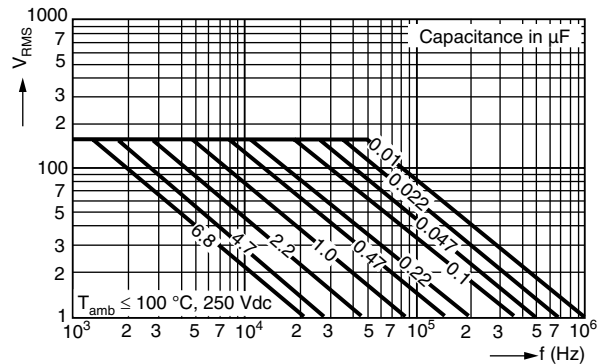

Max. RMS voltage as a function of frequency

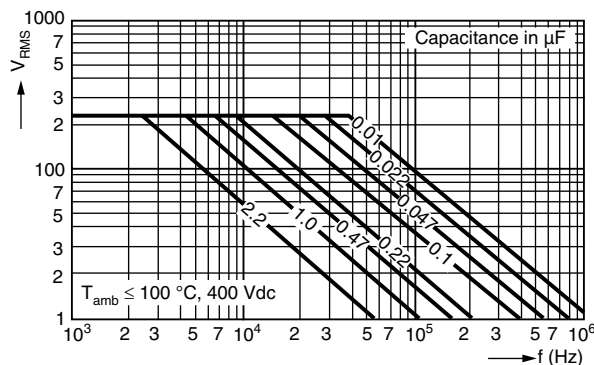

Max. RMS voltage as a function of frequency

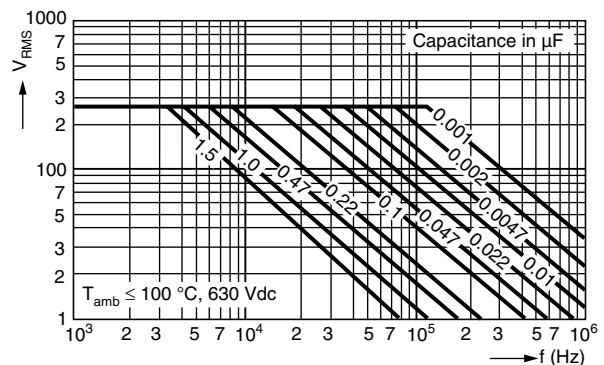

**AC and Pulse Metallized Polypropylene Film Capacitors Vishay Roederstein  
MKP Axial Type****HEAT CONDUCTIVITY (G) AS A FUNCTION OF ORIGINAL PITCH AND CAPACITOR BODY THICKNESS IN mW/°C**

DIAMETER (mm)	HEAT CONDUCTIVITY (mW/°C)					
	L 11 mm	L 14 mm	L 19 mm	L 26.5 mm	L 31.5 mm	L 41.5 mm
5.0	2	3	4	5	6	8
5.5	3	3	4	6	7	9
6.0	3	4	5	7	8	10
6.5	3	4	5	7	9	11
7.0	4	5	6	8	9	12
7.5	4	5	7	9	10	13
8.0	4	5	7	10	11	15
8.5	5	6	8	10	12	16
9.0	5	6	8	11	13	17
9.5	6	7	9	12	14	18
10.0	6	7	10	13	15	19
10.5	7	8	10	14	16	20
11.0	7	8	11	14	17	21
11.5	8	9	12	15	18	23
12.0	8	10	12	16	19	24
12.5	9	10	13	17	20	25
13.0	9	11	14	18	21	26
13.5	10	11	14	19	22	28
14.0	10	12	15	20	23	29
14.5	11	13	16	21	24	30
15.0	11	13	16	21	25	31
15.5	12	14	17	22	26	33
16.0	12	14	18	23	27	34
16.5	13	15	19	24	28	35
17.0	14	16	20	25	29	37
17.5	14	17	20	26	30	38
18.0	15	17	21	27	31	39
18.5	15	18	22	28	32	41
19.0	16	19	23	29	34	42
19.5	17	19	24	30	35	43
20.0	17	20	25	31	36	45
20.5	18	21	25	32	37	46
21.0	19	22	26	33	38	48
21.5	20	22	27	35	39	49
22.0	20	23	28	36	41	50
22.5	21	24	29	37	42	52
23.0	22	25	30	38	43	53
23.5	23	26	31	39	44	55
24.0	23	27	32	40	46	56
24.5	24	27	33	41	47	58
25.0	25	28	34	42	48	59
25.5	26	29	35	44	49	61
26.0	27	30	36	45	51	62
26.5	27	31	37	46	52	64
27.0	28	32	38	47	53	66
27.5	29	33	39	48	55	67
28.0	30	34	40	50	56	69
28.5	31	35	41	51	57	70

## POWER DISSIPATION AND MAXIMUM COMPONENT TEMPERATURE RISE

The power dissipation must be limited in order not to exceed the maximum allowed component temperature rise as a function of the free air ambient temperature.

The power dissipation can be calculated according type detail specification “HQN-384-01/101: Technical Information Film Capacitors with the typical tgδ of the curves”.

The component temperature rise ( $\Delta T$ ) can be measured (see section “Measuring the component temperature” for more details) or calculated by  $\Delta T = P/G$ :

- $\Delta T$  = Component temperature rise ( $^{\circ}\text{C}$ )
- $P$  = Power dissipation of the component (mW)
- $G$  = Heat conductivity of the component ( $\text{mW}/^{\circ}\text{C}$ )

## MEASURING THE COMPONENT TEMPERATURE

A thermocouple must be attached to the capacitor body as in:

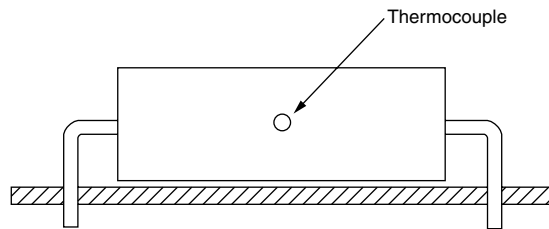

The temperature is measured in unloaded ( $T_{\text{amb}}$ ) and maximum loaded condition ( $T_{\text{C}}$ ).

The temperature rise is given by  $\Delta T = T_{\text{C}} - T_{\text{amb}}$ .

To avoid radiation or convection, the capacitor should be tested in a wind-free box.

## APPLICATION NOTE AND LIMITING CONDITIONS

These capacitors are not suitable for mains applications as across-the-line capacitors without additional protection, as described hereunder. These mains applications are strictly regulated in safety standards and therefore electromagnetic interference suppression capacitors conforming the standards must be used.

To select the capacitor for a certain application, the following conditions must be checked:

1. The peak voltage ( $U_{\text{P}}$ ) shall not be greater than the rated DC voltage ( $U_{\text{Rdc}}$ )
2. The peak-to-peak voltage ( $U_{\text{P-P}}$ ) shall not be greater than the maximum ( $U_{\text{P-P}}$ ) to avoid the ionisation inception level
3. The voltage peak slope ( $dU/dt$ ) shall not exceed the rated voltage pulse slope in an RC-circuit at rated voltage and without ringing. If the pulse voltage is lower than the rated DC voltage, the rated voltage pulse slope may be multiplied by  $U_{\text{Rdc}}$  and divided by the applied voltage.

For all other pulses following equation must be fulfilled:

$$2 \times \int_0^T \left( \frac{dU}{dt} \right)^2 \times dt < U_{\text{Rdc}} \times \left( \frac{dU}{dt} \right)_{\text{rated}}$$

$T$  is the pulse duration.

4. The maximum component surface temperature rise must be lower than the limits (see graph max. allowed component temperature rise).
5. Since in circuits used at voltages over 280 V peak-to-peak the risk for an intrinsically active flammability after a capacitor breakdown (short circuit) increases, it is recommended that the power to the component is limited to 100 times the values mentioned in the table: “Heat conductivity”
6. When using these capacitors as across-the-line capacitor in the input filter for mains applications or as series connected with an impedance to the mains the applicant must guarantee that the following conditions are fulfilled in any case (spikes and surge voltages from the mains included).



AC and Pulse Metallized Polypropylene Film Capacitors Vishay Roederstein  
MKP Axial Type

Voltage Conditions for 6 Above

ALLOWED VOLTAGES	$T_{amb} \leq 85\text{ }^{\circ}\text{C}$	$85\text{ }^{\circ}\text{C} < T_{amb} \leq 100\text{ }^{\circ}\text{C}$
Maximum continuous RMS voltage	$U_{Rac}$	$U_{Rac}$
Maximum temperature RMS-overvoltage (< 24 h)	$1.25 \times U_{Rac}$	$1.25 \times U_{Rac}$
Maximum peak voltage ( $V_{O-P}$ ) (< 2 s)	$1.6 \times U_{Rdc}$	$1.1 \times U_{Rdc}$

INSPECTION REQUIREMENTS

General Notes:

Sub-clause numbers of tests and performance requirements refer to the “Sectional Specification, Publication IEC 60384-16 and Specific Reference Data”.

Group C Inspection Requirements

SUB-CLAUSE NUMBER AND TEST	CONDITIONS	PERFORMANCE REQUIREMENTS
<b>SUB-GROUP C1A PART OF SAMPLE OF SUB-GROUP C1</b>		
4.1 Dimensions (detail)		As specified in chapter “General Data” of this specification
4.3.1 Initial measurements	Capacitance Tangent of loss angle at 100 kHz	No visible damage
4.3 Robustness of terminations	Tensile and bending	
4.4 Resistance to soldering heat	Method: 1A Solder bath: $280\text{ }^{\circ}\text{C} \pm 5\text{ }^{\circ}\text{C}$ Duration: 5 s	
4.14 Component solvent resistance	Isopropylalcohol at room temperature Method: 2 Immersion time: $5 \pm 0.5\text{ min}$ Recovery time: Min. 1 h, max. 2 h	
4.4.2 Final measurements	Visual examination  Capacitance Tangent of loss angle	
<b>SUB-GROUP C1B OTHER PART OF SAMPLE OF SUB-GROUP C1</b>		
4.6.1 Initial measurements	Capacitance Tangent of loss angle: For $C \leq 1\text{ }\mu\text{F}$ at 10 kHz For $C > 1\text{ }\mu\text{F}$ at 1 kHz	No visible damage Legible marking
4.15 Solvent resistance of the marking	Isopropylalcohol at room temperature Method: 1 Rubbing material: Cotton wool Immersion time: $5 \pm 0.5\text{ min}$	
4.6 Rapid change of temperature	$\theta A$ = Lower category temperature $\theta B$ = Upper category temperature 5 cycles Duration $t = 30\text{ min}$	





SUB-CLAUSE NUMBER AND TEST	CONDITIONS	PERFORMANCE REQUIREMENTS
4.7 Vibration  4.7.2 Final inspection 4.9 Shock  4.9.3 Final measurements	Visual examination Mounting: See section "Mounting" for more information Procedure B4 Frequency range: 10 Hz to 55 Hz Amplitude: 0.75 mm or Acceleration 98 m/s <sup>2</sup> (whichever is less severe) Total duration 6 h  Visual examination Mounting: See section "Mounting" for more information Pulse shape: Half sine Acceleration: 490 m/s <sup>2</sup> Duration of pulse: 11 ms  Visual examination Capacitance Tangent of loss angle  Insulation resistance	No visible damage  No visible damage  No visible damage $ \Delta C/C  \leq 2\%$ of the value measured in 4.6.1 Increase of $\tan \delta \leq 0.002$ Compared to values measured in 4.6.1 As specified in section "Insulation Resistance" of this specification
<b>SUB-GROUP C1 COMBINED SAMPLE OF SPECIMENS OF SUB-GROUPS C1A AND C1B</b>		
4.10 Climatic sequence 4.10.2 Dry heat  4.10.3 Damp heat cyclic Test Db, first cycle 4.10.4 Cold  4.10.6 Damp heat cyclic Test Db, remaining cycles 4.10.6.2 Final measurements	Temperature: Upper category temperature Duration: 16 h  Temperature: Lower category temperature Duration: 2 h Visual examination  Capacitance  Tangent of loss angle  Insulation resistance	No visible damage Legible marking $ \Delta C/C  \leq 3\%$ of the value measured in 4.4.2 or 4.9.3 Increase of $\tan \delta \leq 0.003$ Compared to values measured in 4.3.1 or 4.6.1 $\geq 50\%$ of values specified in section "Insulation Resistance" of this specification
<b>SUB-GROUP C2</b>		
4.11 Damp heat steady state 4.11.1 Initial measurements 4.11.3 Final measurements	Capacitance Tangent of loss angle at 1 kHz Visual examination  Capacitance  Tangent of loss angle  Insulation resistance	No visible damage Legible marking $ \Delta C/C  \leq 3\%$ of the value measured in 4.11.1. Increase of $\tan \delta \leq 0.001$ Compared to values measured in 4.11.1 $\geq 50\%$ of values specified in section "Insulation Resistance" of this specification
<b>SUB-GROUP C3</b>		
4.12 Endurance DC  4.12.1 Initial measurements	Duration: 2000 h 1.25 x U <sub>Rdc</sub> at 85 °C 0.875 x U <sub>Rdc</sub> at 100 °C Capacitance Tangent of loss angle: For C ≤ 1 μF at 10 kHz For C > 1 μF at 1 kHz	



AC and Pulse Metallized Polypropylene Film Capacitors Vishay Roederstein  
MKP Axial Type

SUB-CLAUSE NUMBER AND TEST	CONDITIONS	PERFORMANCE REQUIREMENTS
4.12.5 Final measurements	Visual examination  Capacitance  Tangent of loss angle  Insulation resistance	No visible damage Legible marking $ \Delta C/C  \leq 3\%$ compared to values measured in 4.12.1  Increase of $\tan \delta \leq 0.002$ Compared to values measured in 4.12.1  $\geq 50\%$ of values specified in section "Insulation Resistance" of this specification
<b>SUB-GROUP C4</b>		
4.2.6 Temperature characteristics Initial measurement Intermediate Intermediate measurements  Final measurements	Capacitance Capacitance at lower category temperature Capacitance at 20 °C Capacitance at upper category temperature  Capacitance Tangent of loss angle: For $C \leq 1 \mu\text{F}$ at 10 kHz For $C > 1 \mu\text{F}$ at 1 kHz  Insulation resistance	For - 55 °C to + 20 °C: $0\% \leq  \Delta C/C  \leq 2\%$ or for 20 °C to 85 °C: $- 3\% \leq  \Delta C/C  \leq 0\%$  As specified in section "Capacitance" of this specification  As specified in section "Insulation Resistance" of this specification
4.13 Charge and discharge	10 000 cycles Charged to $U_{Rdc}$ Discharge resistance: $R = \frac{U_{Rdc}}{2.5 \times C(dU/dt)}$	
4.13.1 Initial measurements	Capacitance Tangent of loss angle at 100 kHz	
4.13.3 Final measurements	Capacitance Tangent of loss angle  Insulation resistance	$ \Delta C/C  \leq 3\%$ of the value measured in 4.13.1 Increase of $\tan \delta \leq 0.003$ Compared to values measured in 4.13.1  $\geq 50\%$ of values specified in section "Insulation Resistance" of this specification



## Disclaimer

All product specifications and data are subject to change without notice.

Vishay Intertechnology, Inc., its affiliates, agents, and employees, and all persons acting on its or their behalf (collectively, "Vishay"), disclaim any and all liability for any errors, inaccuracies or incompleteness contained herein or in any other disclosure relating to any product.

Vishay disclaims any and all liability arising out of the use or application of any product described herein or of any information provided herein to the maximum extent permitted by law. The product specifications do not expand or otherwise modify Vishay's terms and conditions of purchase, including but not limited to the warranty expressed therein, which apply to these products.

No license, express or implied, by estoppel or otherwise, to any intellectual property rights is granted by this document or by any conduct of Vishay.

The products shown herein are not designed for use in medical, life-saving, or life-sustaining applications unless otherwise expressly indicated. Customers using or selling Vishay products not expressly indicated for use in such applications do so entirely at their own risk and agree to fully indemnify Vishay for any damages arising or resulting from such use or sale. Please contact authorized Vishay personnel to obtain written terms and conditions regarding products designed for such applications.

Product names and markings noted herein may be trademarks of their respective owners.



Компания «ЭлектроПласт» предлагает заключение долгосрочных отношений при поставках импортных электронных компонентов на взаимовыгодных условиях!

Наши преимущества:

- Оперативные поставки широкого спектра электронных компонентов отечественного и импортного производства напрямую от производителей и с крупнейших мировых складов;
- Поставка более 17-ти миллионов наименований электронных компонентов;
- Поставка сложных, дефицитных, либо снятых с производства позиций;
- Оперативные сроки поставки под заказ (от 5 рабочих дней);
- Экспресс доставка в любую точку России;
- Техническая поддержка проекта, помощь в подборе аналогов, поставка прототипов;
- Система менеджмента качества сертифицирована по Международному стандарту ISO 9001;
- Лицензия ФСБ на осуществление работ с использованием сведений, составляющих государственную тайну;
- Поставка специализированных компонентов (Xilinx, Altera, Analog Devices, Intersil, Interpoint, Microsemi, Aeroflex, Peregrine, Syfer, Eurofarad, Texas Instrument, Miteq, Cobham, E2V, MA-COM, Hittite, Mini-Circuits, General Dynamics и др.);

Помимо этого, одним из направлений компании «ЭлектроПласт» является направление «Источники питания». Мы предлагаем Вам помощь Конструкторского отдела:

- Подбор оптимального решения, техническое обоснование при выборе компонента;
- Подбор аналогов;
- Консультации по применению компонента;
- Поставка образцов и прототипов;
- Техническая поддержка проекта;
- Защита от снятия компонента с производства.



#### Как с нами связаться

**Телефон:** 8 (812) 309 58 32 (многоканальный)

**Факс:** 8 (812) 320-02-42

**Электронная почта:** [org@eplast1.ru](mailto:org@eplast1.ru)

**Адрес:** 198099, г. Санкт-Петербург, ул. Калинина, дом 2, корпус 4, литера А.