



The Future of Analog IC Technology®

# HR2000

## Fluorescent Lamp HB Driver with PFC

### DESCRIPTION

The HR2000 is a fluorescent lamp ballast controller with PFC function and high voltage half-bridge driver. Only 16pin is used to offer cost effective solutions with minimized external components.

The HR2000 can properly drive the two MOSFETs of half-bridge to control fluorescent lamp, ensuring all the features at the same time. The operating frequency is programmable and the sweeping frequency is controlled to limit the preheat current. The preheat time and ignition time can be smartly set up for types of lamps and applications. Sufficient protection functions are provided for different fault modes such as over voltage, over current, over temperature, capacitive mode, end of life (EOL). Preheat driving signal is offered in preheat state to meet low power loss application which usually needs a MOSFET to cut off filament transformer.

The PFC part only uses 4 pins to realize PFC function with On-time (Ton) control at boundary conduction mode (BCM). It is suitable for wide input range. Over voltage protection and over current protection are integrated for the PFC part.

The HR2000 is available in the 16-pin SOIC16 package.

### FEATURES

#### PFC PART

- Only four pins realize PFC function.
- Ton control.
- Boundary Conduction Mode operation.
- Less peripheral components.
- Over voltage and over current protection.

#### HALF-BRIDGE PART

- 600V bootstrap half-bridge driver.
- Programmable preheat current.
- Programmable preheat time.
- Programmable ignition time.
- Single ignition attempt.
- Over voltage protection.
- Over current protection.
- End-Of-Life protection
- Capacitive mode protection.
- Minimized external components.
- Over temperature protection

### APPLICATIONS

- Tube fluorescent lamp ballast
- Compact fluorescent lamp ballast

All MPS parts are lead-free and adhere to the RoHS directive. For MPS green status, please visit MPS website under Quality Assurance. "MPS" and "The Future of Analog IC Technology" are Registered Trademarks of Monolithic Power Systems, Inc.

TYPICAL APPLICATION

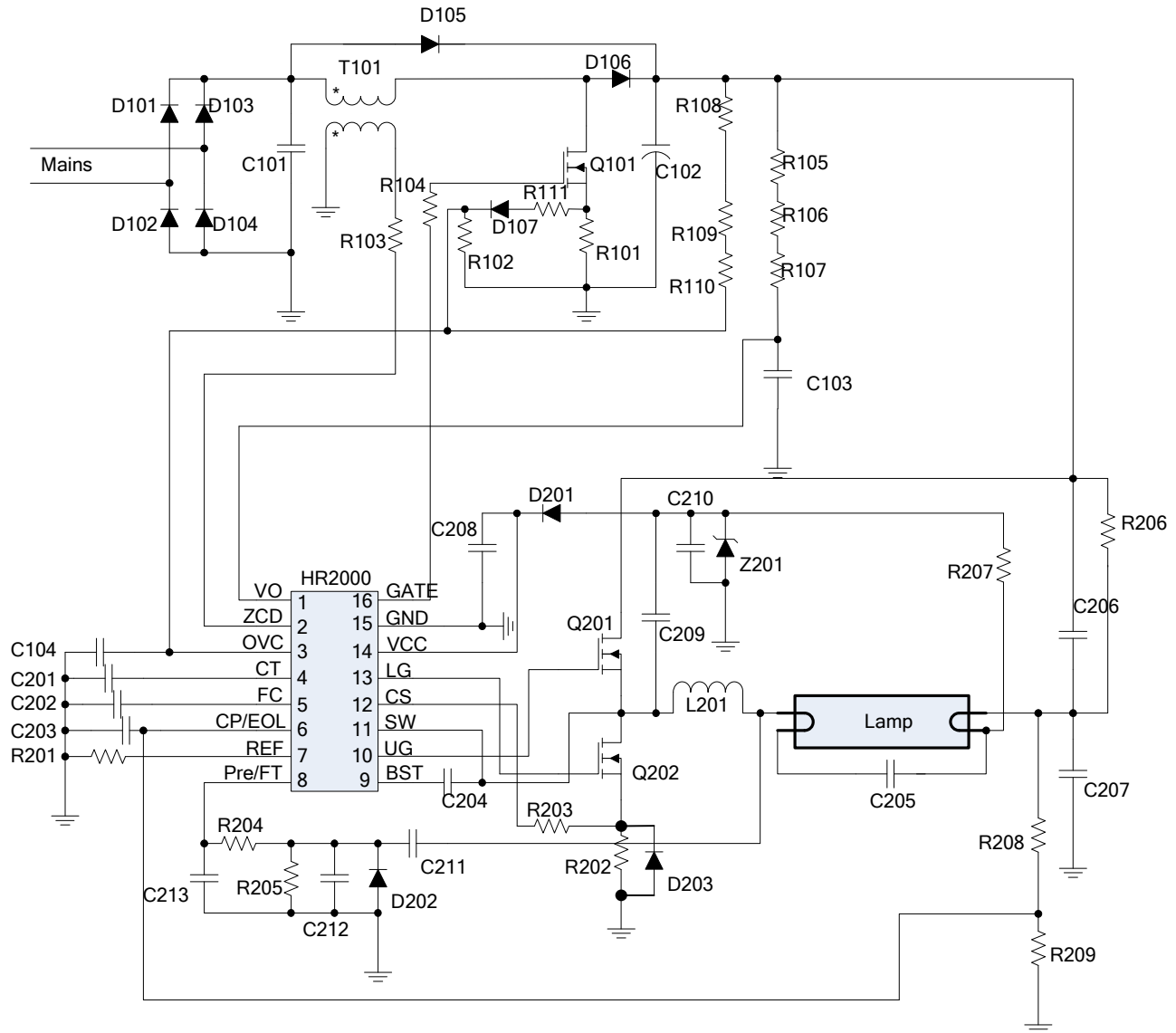

Figure 1

## ORDERING INFORMATION

Part Number*	Package	Top Marking
HR2000GS	SOIC16	HR2000

\* For Tape & Reel, add suffix -Z (e.g. HR2000GS-Z).

## PACKAGE REFERENCE

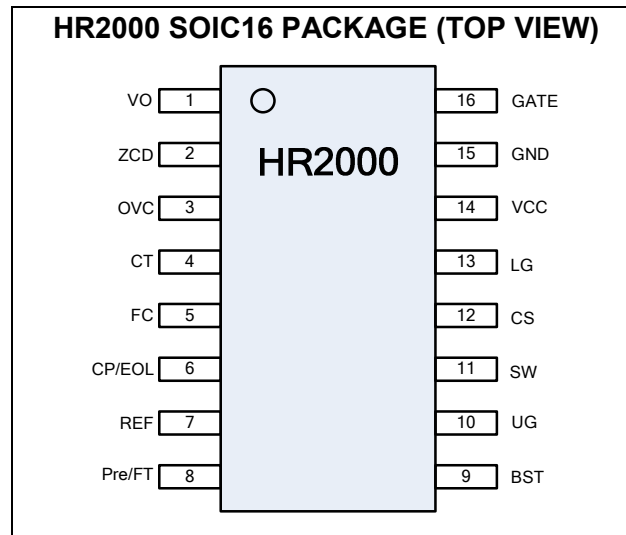

**LIMITING VALUE <sup>(1)</sup>**

		Condition	Symbol	Min.	Max.	Unit
A	High side floating supply voltage	Operation	V <sub>bst</sub>		630	V
B	Voltage at SW		V <sub>sw</sub>	-3	630	V
C	Voltage at pin CS	Note7	V <sub>cs</sub>	-0.5	V <sub>BE</sub>	V
D	Current in pin CS	t<1.0μs, note4	I <sub>cs</sub>	-10	10	mA
E	Voltage at pin UG	Note7	V <sub>UG</sub>	V <sub>sw</sub> -V <sub>BE</sub>	V <sub>BST</sub>	V
F	Voltage at pin LG	Note7	V <sub>LG</sub>	-V <sub>BE</sub>	V <sub>VCC</sub>	V
G	Low voltage supply	t<0.5s over lifetime	V <sub>vcc</sub>	0	15	V
H	Low voltage supply		V <sub>vcc</sub>	0	14	V
I	Clamp current in pin VCC	In fault state	I <sub>vcc</sub>		5	mA
I	Voltage at pin ZCD		V <sub>zcd</sub>	-7	7	V
J	Voltage at pin OVC		V <sub>ovc</sub>	0	5	V
K	Current in pin VO	V <sub>vcc</sub> =0 to V <sub>vccmax</sub>	I <sub>vo</sub>	0	200	μA
L	Current in pin CT	V <sub>vcc</sub> =0 to V <sub>vccmax</sub>	I <sub>ct</sub>	0	200	μA
M	Current in pin CP/EOL	V <sub>vcc</sub> =0 to V <sub>vccmax</sub> Note9	I <sub>EOL</sub>	-1	1	mA
N	Slew rate at pins SW, HG and BST	With respect to ground	SR	-4	4	V/ns
O	Junction temperature		T <sub>j</sub>		150	°C
P	Ambient temperature		T <sub>amb</sub>	-40	125	°C
Q	Storage temperature		T <sub>stg</sub>	-55	150	°C
R	HBM electrostatic handling voltage SW, HG, BST, VCC and LG VO, OVC, CT, FC, CP/EOL, REF, Pre/FT, CS, ZCD, GATE	Note5	V <sub>esd</sub> (HBM)		2000	V V
S	MM electrostatic handling voltage Pins Pre/FT	Note6	V <sub>esd</sub> (MM)		150	V
	Pins VO, OVC, CT, FC, CP/EOL, REF, CS, ZCD, GATE, SW, HG, BST, VCC and LG				200	V
T	Charge coupling at pins REF and CT	Operating	Q <sub>coupl</sub>	-8	8	pC
U	Reference resistor		R <sub>REF</sub>	36	91	kΩ

**Recommended Operating Conditions <sup>(3)</sup>**

Supply Voltage VCC ..... 10V to 12V  
 Analog inputs and outputs ..... -0.3V to 6.5V  
 Operating Junction Temp (T<sub>J</sub>) . -40°C to + 125°C

**Thermal Resistance <sup>(4)</sup>**      θ<sub>JA</sub>      θ<sub>JC</sub>  
 SOIC16.....80.....35 ... °C/W

**Notes:**

- Exceeding these ratings may damage the device.
- The maximum allowable power dissipation is a function of the maximum junction temperature T<sub>J</sub>(MAX), the junction-to-ambient thermal resistance θ<sub>JA</sub>, and the ambient temperature T<sub>A</sub>. The maximum allowable continuous power dissipation at any ambient temperature is calculated by D(MAX)=(T<sub>J</sub>(MAX)-T<sub>A</sub>)/ θ<sub>JA</sub>. Exceeding the maximum allowable power dissipation will cause excessive die temperature, and the regulator will go into thermal shutdown. Internal thermal shutdown circuitry protects the device from permanent damage.
- The device is not guaranteed to function outside of its operating conditions.
- Measured on JESD51-7, 4-layer PCB
- In accordance with the Human Mody Model (HBM), i.e. equivalent to discharging a 100pF capacitor through a 1.5kΩ series resistor
- In accordance with the Mancine Model (MM), i.e. equivalent to discharging a 200pF capacitor through a 10Ω series resistor and a 0.75μH inductor.
- At T<sub>amb</sub>=25°C the typical V<sub>BE</sub> IS 0.7V.
- At negative CS currents (typ<-5mA) the capacitive mode protection can be triggered.
- When EOL detection is enabled

## ELECTRICAL CHARACTERISTICS

Ta=25°C; Vvcc=13.0V; C<sub>CT</sub>=100pF; R<sub>REF</sub>=51kohm; C<sub>CP/EOL</sub>=100n, C<sub>FC</sub>=100nF; all voltage referenced to ground; unless otherwise specified.

No	Condition	Symbol	MIN.	TYP.	MAX.	UNIT
<b>High voltage supply</b>						
1.0	Leakage current high voltage pins SW,HG,BST=630V, Vvcc=0	I <sub>Leak</sub>			15	µA
<b>Start-up state</b>						
2.0	Start of oscillation	VCC(start)	11.2	12	12.8	V
2.1	Stop of oscillation	VCC(low)	7.7	8.2	8.7	V
2.2	Non-oscillating current	Vvcc=11V;note2 Ivcc(nonosc)	230	285	340	µA
2.3	Clamp voltage VCC	At 5mA non-oscillating VCC(clamp)	14.5	16	17	V
2.4	Reset voltage	Note8 VCC(reset)	4.5	5.5	6.5	V
<b>Preheat State</b>						
3.0	Starting frequency	VFC=0, note1 Fstart	96	102	108	kHz
3.1	Preheat time	CCP=100nF Tph	540	620	700	ms
3.2	Charge current at CP/EOL pin	Vcpeol=1.0V, note10 I <sub>CP</sub> (charge)		6.0		µA
3.3	Discharge current at CP/EOL pin	Vcpeol=3.5V, note10 I <sub>CP</sub> (disch)		6.0		µA
3.4	Peak voltage difference at CP/EOL pin	When timing ΔCC <sub>PEOL</sub> (pk)		2.25		V
3.5	CP comparator level low	V <sub>CP</sub> (min)	1.15	1.25		V
3.6	Control voltage at CS pin	Note3 Vcs(pre)	375	410	445	mV
3.7	Maximum voltage at Pre/FT pin	Vpre		VCC		V
<b>Ignition state</b>						
4.0	Ignition time	CCP=100n Tig	500	600	700	ms
4.1	Saturation current detection level	At ICS(ig)=0.1mA Vcs(clamp)		0.75		V
4.2	over current feedback gain	Note4 koc	0.9	1	1.1	A/A
4.3	Pre/FT pin reset level	After preheat, Pre/FT will be dropped to this level. Then detecting the voltage at Pre/FT is active. Vfault(reset2)	150	200	250	mV
<b>Burn State</b>						
5.0	Bottom frequency	Note1 f <sub>B</sub>	42	43.5	45	kHz
5.1	Non-overlap time	T <sub>NO</sub>	0.85	1.20	1.55	µs
5.2	Symmetry half-bridge	Note1,7 SYM f <sub>B</sub>	0.9	1.0	1.1	
5.3	Symmetry non-overlap time	Note 9 SYM T <sub>NO</sub>		1.0		
5.4	Total supply current	Notes 1,5 Itot		1.7	2.5	mA
5.5	Charge current at FC pin	VFC=1.5V I <sub>FC</sub> (ch)	43	50	57	µA
5.6	Discharge current at FC pin	VFC=1.5V I <sub>FC</sub> (disch)	84	100	116	µA
5.7	FC transconductance	VFC=1.5V ΔI <sub>CT</sub> /ΔV <sub>FC</sub>		10		µA/V
5.8	Capacitive mode control voltage	Note6 Vcs(cap)	-32	-14	0	mV
5.9	Reference voltage	Vref	2.425	2.500	2.575	V
5.10	On voltage at pin UG	IUG =1mA VUG(on)		12.96		V
5.11	Off voltage at pin UG	IUG =1mA VUG(off)		16		mV
5.12	On voltage at pin LG	ILG =1mA VLG(on)		12.96		V

**ELECTRICAL CHARACTERICS (continued)**

Ta=25°C; Vvcc=13.0V; C<sub>CT</sub>=100pF; R<sub>REF</sub>=51kohm; C<sub>CP/EOL</sub>=100n, C<sub>FC</sub>=100nF; all voltage referenced to ground; unless otherwise specified.

No	Condition	Symbol	MIN.	TYP.	MAX.	UNIT
5.13	Off voltage at pin LG	ILG =1mA		16		mV
5.14	Up side driver on resistance			33		Ω
5.15	Up side driver off resistance			16		Ω
5.16	Low side driver on resistance			33		Ω
5.17	Low side driver off resistance			16		Ω
5.18	Voltage drop at bootstrap switch	10mA source current		1.7		V
5.19	On resistance of the discharge switch at CP/EOL pin			14		kΩ
5.20	On resistance connected Pre/FT pin and VCC pin			16		kΩ
<b>Fault and End of Life</b>						
6.0	Fault reference level			1.22		V
6.1	Fault reset level	Note8		0.9		V
6.2	Fault charge current source	V <sub>PreFT</sub> =0.75V		3.2		μA
6.3	Fault discharge current	V <sub>PreFT</sub> =0.75V		0.62		μA
6.4	On resistance discharge switch	V <sub>PreFT</sub> =0.5V		16		kΩ
6.5	High level EOL comparator		2.9	3.0	3.1	V
6.6	Low level EOL comparator		1.9	2.0	2.1	V
<b>Power Factor Control</b>						
7.0	Output voltage reference current	Vvo=3.0V		102	107	μA
7.1	OVC reference level		1.22	1.27	1.32	V
7.2	Delay OVC comparator			100		ns
7.3	VO offset voltage			0.72		V
7.4	VO dynamic range			3.1		V
7.5	Maximum on time	Vvo=Vvo(low)	20			μs
7.6	ZCD reference			2		V
7.7	Duration off pulse			1.4		μs
7.8	OVC low voltage			94		mV
7.9	VO low reference		80	90	100	μA
7.10	Off-voltage PFC			3.8		V
7.11	Active VO clamp voltage	Ivo=200μA		6.2		V
7.12	Passive VO clamp voltage	Ivo=200μA, Vvcc=0V		3.5		V
7.13	Gate pull down resistance		R <sub>gate pull down</sub>	14		Ω

**NOTES**

- Excluding situations where the over current protection is active.
- The non oscillation current is specified in a temperature range of 0 to 100 °C. For T<sub>j</sub> < 0 °C and T<sub>j</sub> > 100 °C the maximum start-up current is 350 mA.
- Data sampling of VCS(ph) is performed at the end of conduction of T2.
- Gain is defined as ICT/ICS with VCS>VCS(clamp).
- Total supply current is specified in a T<sub>j</sub> temperature range of -20 °C to 125 °C at fB, excluding gate drive charge.
- Data sampling of VCS(cap) is performed at the start of
- conduction of T2.
- The symmetry SYM fB is calculated from the quotient SYM fB = T1tot/T2tot, with T1tot the time between turn-off of G2 and the turn-off of G1, and T2tot the time between turn-off of G1 and the turn-off of G2.
- Not measured, guaranteed by design.
- The symmetry SYM TNO is defined as the ratio between deadtime1 and deadtime2. Deadtime1 is the time between turning off G1 and turning on G2. Deadtime2 is the time between turning off G2 and turning on G1.
- Preheat & ignition states.

# TYPICAL CHARACTERISTICS

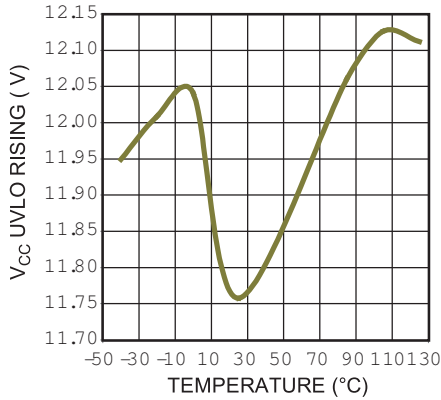
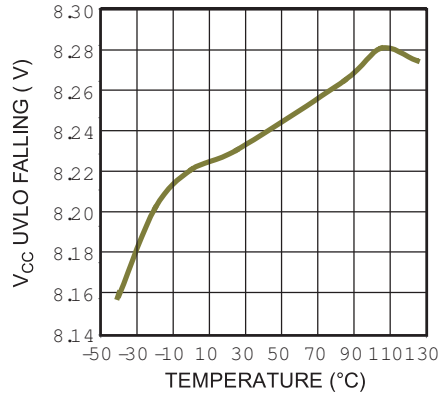
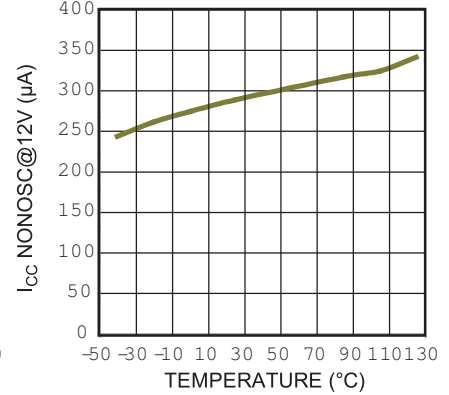
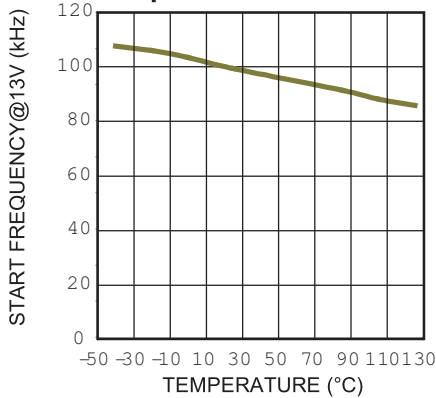
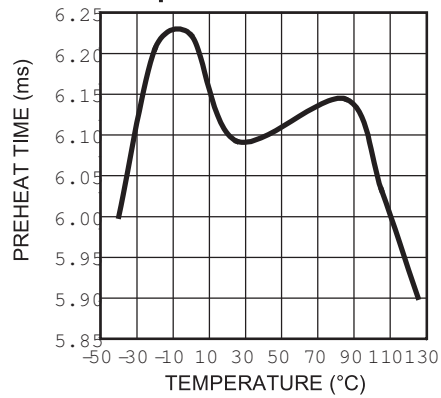
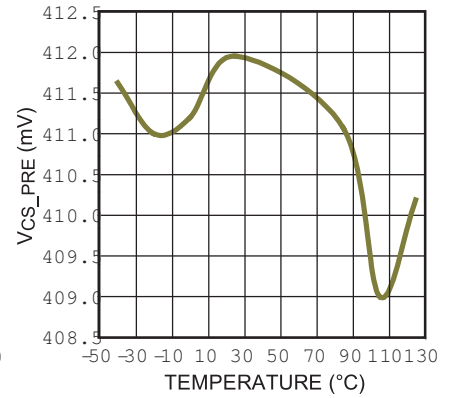
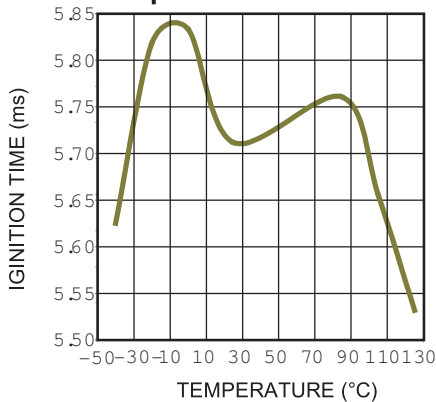
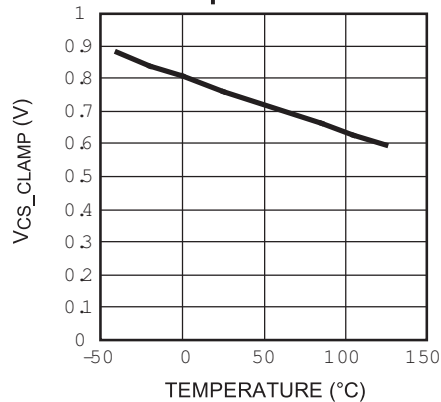
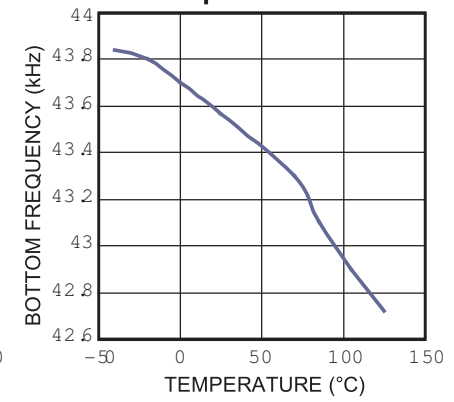
**V<sub>CC</sub> UVLO Rising Threshold vs. Temperature**

**V<sub>CC</sub> UVLO Falling Threshold vs. Temperature**

**Supply Current @ Non-oscillation vs. Temperature**

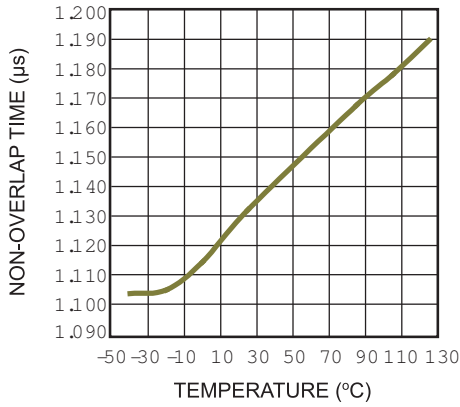
**Start Frequency vs. Temperature**

**Preheat Time vs. Temperature**

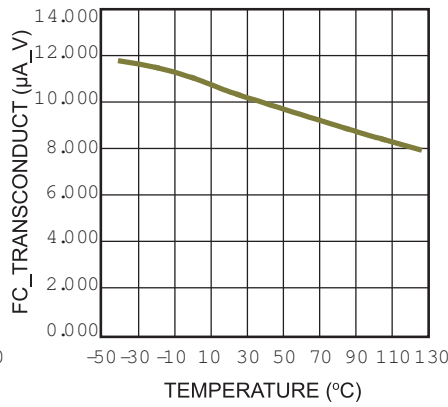
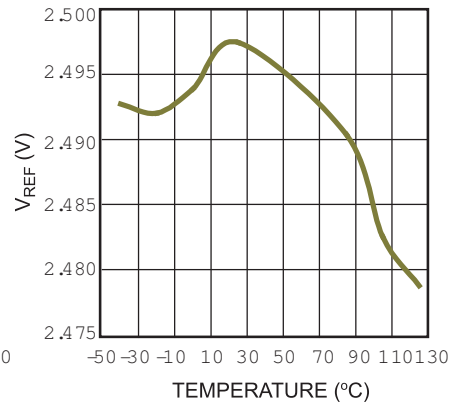
**V<sub>CS\_PRE</sub> vs. Temperature**

**Ignition Time vs. Temperature**

**CS Clamp Voltage @100µA vs. Temperature**

**Bottom Frequency vs. Temperature**

**TYPICAL CHARACTERISTICS (continued)**

Non-overlap Time vs. Temperature



FC Transconductance vs. Temperature

 $V_{REF}$  vs Temperature

CS Capacitive Mode Detection Threshold vs. Temperature

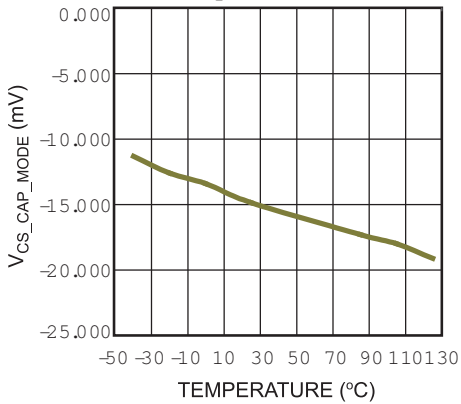

Voltage Drop at Bootstrap Fault Reference Level Switch vs. Temperature

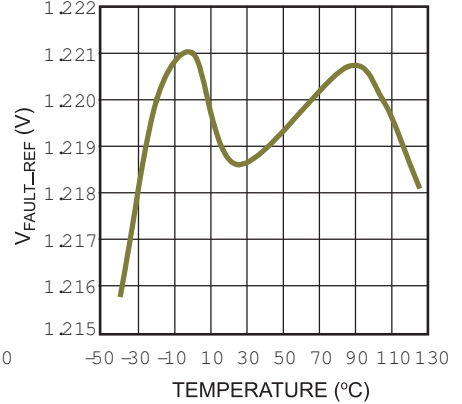
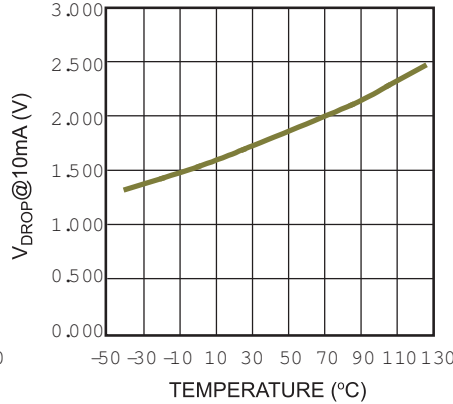

Output Voltage Reference Current vs. Temperature

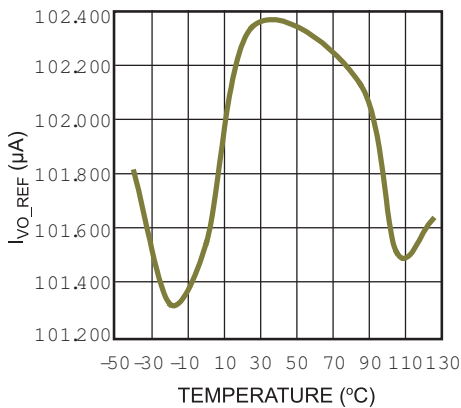

OVC Reference Voltage vs. Temperature

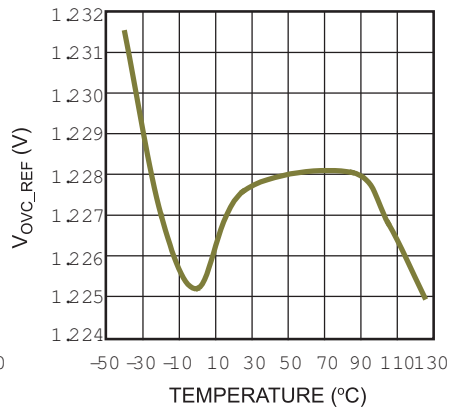

Gate Maximum on Time vs. Temperature

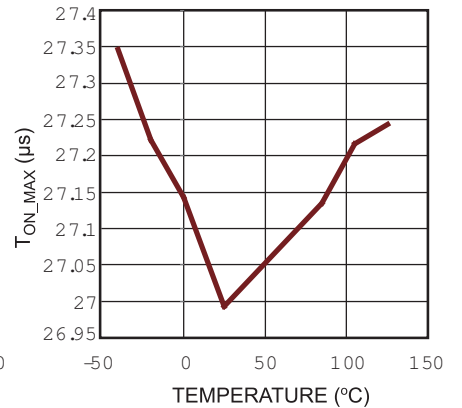



**TYPICAL CHARACTERISTICS (continued)**

Duration Offtime vs. Temperature

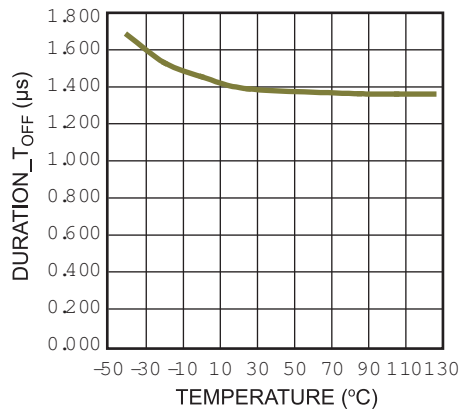

V<sub>OUT</sub> Low Reference Current vs. Temperature

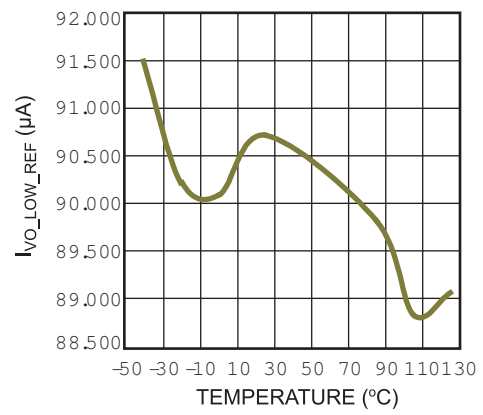

## TYPICAL PERFORMANCE CHARACTERISTICS *(continued)*

Performance waveforms are tested on the evaluation board of the Application Example.

$V_{IN} = 220VAC$ , 18W FL load,  $C_{CT}=100pF$ ,  $R_{REF}=51k\Omega$ ,  $C_{CP/EOL}=100n$ ,  $C_{FC}=33nF$ ,  $T_A = 25^\circ C$ , unless otherwise noted.

### PFC

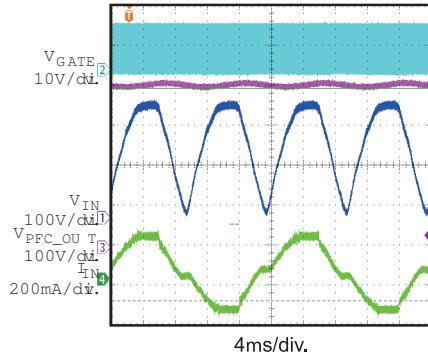

### OVP and Recover

Pull VO Pin Low and Release

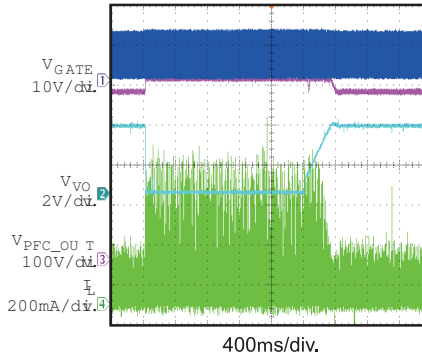

### Over Current Protection

Increase  $R_{SENSE\_PFC}$

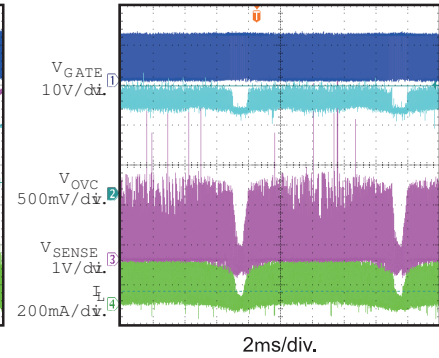

### Start Up

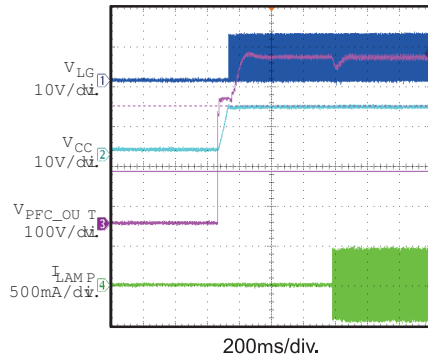

### Preheat & Ignition

Controlled Preheat Time, Frequency, Current/Lamp Voltage

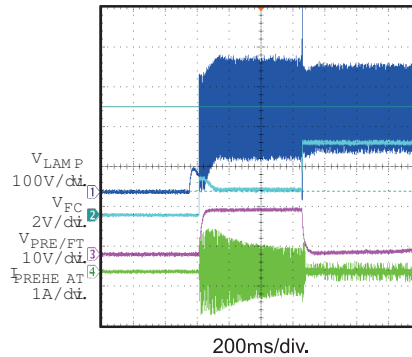

### Burn State

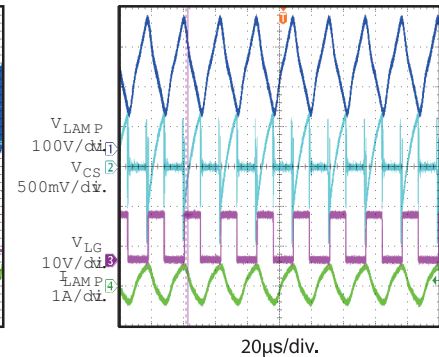

### Quick Power On/Off

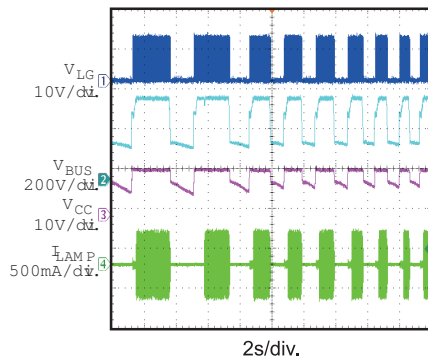

### EOL Protection

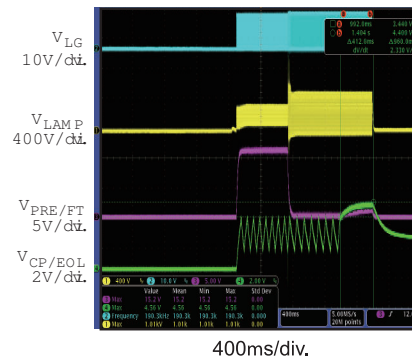

### Capacitive Mode Protection (Always Soft Switching)

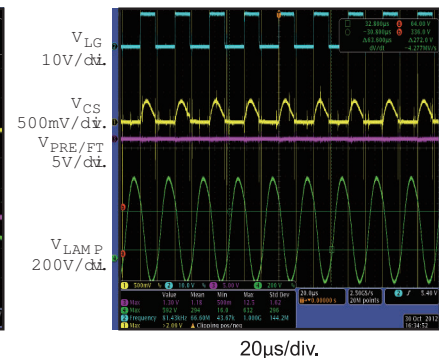

## TYPICAL PERFORMANCE CHARACTERISTICS *(continued)*

Performance waveforms are tested on the evaluation board of the Application Example.

$V_{IN} = 220VAC$ , 18W FL load,  $C_{CT}=100pF$ ,  $R_{REF}=51k\Omega$ ,  $C_{CP/EOL}=100n$ ,  $C_{FC}=33nF$ ,  $T_A = 25^\circ C$ , unless otherwise noted.

Open Lamp Protection

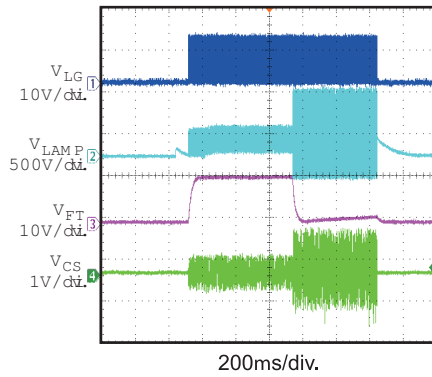

Short Lamp and Recover

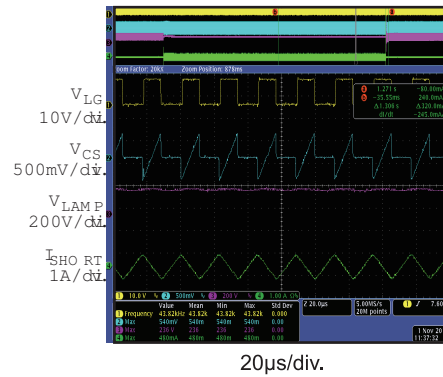

## PIN FUNCTIONS

Pin #	Name	Description
1	VO	PFC output control pin. Connect a resistor from this pin to the PFC output to set the PFC output voltage. Connect a capacitor (or a R-C-C network) from this pin to GND for the compensation of the PFC regulation loop.
2	ZCD	PFC inductor zero current detection pin.
3	OVC	PFC over voltage/current protection pin.
4	CT	Frequency setting capacitor pin. Connect a capacitor from this pin to GND to set the frequency.
5	FC	Frequency control pin. It is voltage controlled oscillator (VCO) pin for controlling half bridge frequency.
6	CP/EOL	Preheat/ignition timing pin and EOL detector. A capacitor from this pin to GND sets the preheat time and ignition time. Before half-bridge works, it is discharged internally to GND. In the preheat state and ignition state, a triangle waveform is generated on this pin and used as a timer. The voltage of the blocking capacitor is sensed to this pin to indicate the EOL condition. After preheat and ignition state, the voltage at this pin is internally discharged to the middle of the EOL window comparator's reference, and then the lamp's EOL information is under monitoring. If EOL condition is confirmed, an internal current source charges the Pre/FT pin's capacitor.
7	REF	Internal reference current setting resistor pin. Connect a resistor from this pin to GND to set the frequency.
8	Pre/FT	In the preheat state, this pin outputs a high level voltage to drive the external preheating MOSFET. After this period, it is discharged to V <sub>fault</sub> (reset2). Then it is used as a fault timer to stop IC at fault condition. At fault condition, an internal current source charges up this pin, and when its voltage hits the fault reference threshold, IC latches up. Connect a capacitor on this pin to set the fault timer.
9	BST	Bootstrap voltage supply for half bridge level shifter. Connect a capacitor (usually 10nF to 100nF) between this pin and SW pin.
10	UG	Half bridge up side MOSFET driver.
11	SW	Half bridge floating middle point.
12	CS	Half bridge current sensor.
13	LG	Half bridge low side MOSFET driver.
14	VCC	Supply voltage of the IC.
15	GND	Ground
16	GATE	PFC GATE driver pin.

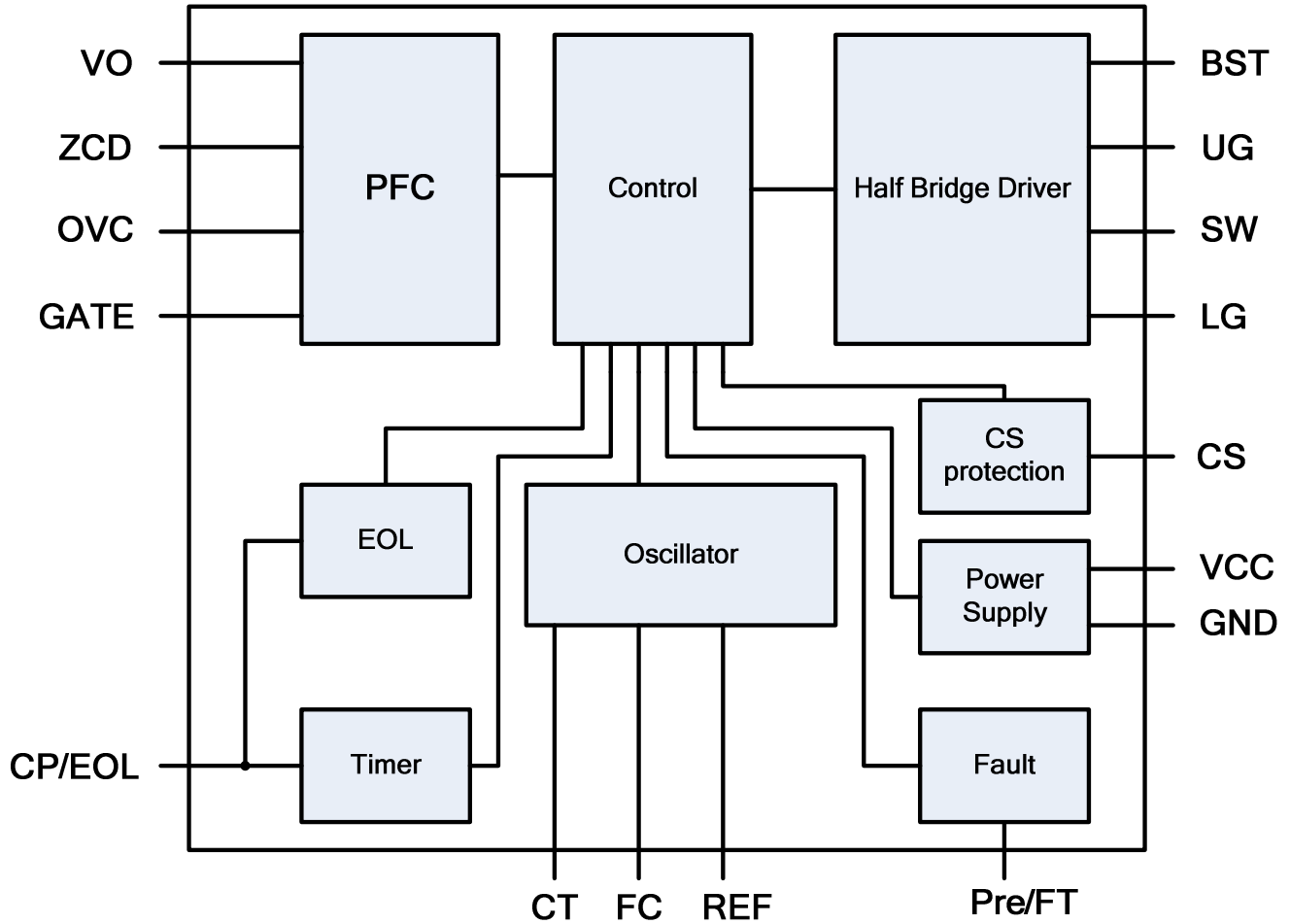

Figure 2— Block Diagram

## FUNCTIONAL DESCRIPTION

HR2000 includes Half-bridge part and PFC part.

### Half-bridge part

In the typical application, the half-bridge can be defined to two basic states: Oscillating state and None-oscillating state.

### Non oscillating state:

In non-oscillating state, IC stops to work. There are 4 sub-states:

- Start up state;
- Fault state;
- VCC under voltage state;
- Over temperature protection (OTP) state

### Start-up state

When  $V_{cc} < V_{cc}(\text{reset})$ , HR2000 will get into Start-up state.

Initially, the IC can be supplied from the outside resistor such as R207 in Figure1.

All internal circuit is reset in this state.

In this state, CP/EOL, Pre/FT, FC pin are discharged by the internal switches.

### Fault state

There are two conditions resulting in Fault state.

The first one is before  $V_{vcc} > V_{vcc}(\text{reset})$ , if  $V_{PreFT} > V_{fault}(\text{reset})$ , then IC will not start up.

The second one is after Pre/FT pin's detection function is active in all oscillating sub-states, HR2000 will get into Fault state if Pre/FT pin voltage  $V_{PreFT} > V_{fault}(\text{ref})$  & low side drive is high.

The following items will affect Pre/FT pin in oscillation state.

The voltage detected by the sample circuit such as C211, C212, C213, D202, R204, R205 in Fig1.

In EOL protection and Capacitive Mode protection, a current source  $I_{fault}(ch)$  will charge the capacitor at this pin such as C213 in Fig1.

In PFC VO-low state a current source  $I_{fault}(\text{disch})$  will discharge C213.

Before  $V_{vcc} > V_{vcc}(\text{reset})$ , this pin will be detected. If  $V_{PreFT} > V_{fault}(\text{reset})$ , IC will not start up.

### VCC under voltage state

There is a hysteresis for Vcc detection. When power on, HR2000 begin's to work after  $V_{vcc} > V_{vcc}(\text{start})$ . If  $V_{vcc} < V_{vcc}(\text{low})$  & low side drive is high in oscillation state, the device will get into VCC under voltage state.

### OTP state

The temperature is monitor by IC internal circuit. If detected temperature is higher than  $T_{high}$ , then IC will get into non-oscillation state. When temperature is lower than  $T_{low}$ , the oscillation is enabled again.

### Oscillating State

After start-up state, once the VCC pin gets to the level  $V_{CC}(\text{start})$ , IC begins to work.

In oscillating state, there are 3 sub-states:

- Preheat state;
- Ignition state;
- Burn state;

### Half-bridge oscillator

The oscillating frequency is programmed by the capacitor on CT pin. The capacitor on CT pin is charged by internal current source which is related to REF pin resistor and FC pin voltage which is voltage controlled current source for CT pin. The waveform of CT pin is saw-tooth and its frequency is twice of the half-bridge operating frequency. There is a dead time between UG and LG for ensuring their non-overlap operating. The dead time is defined by REF resistor.

FC pin controls the operating frequency directly. Higher  $V_{fc}$  results in a lower frequency.

### Preheat State

When  $V_{vcc} > V_{vcc}(start)$  &  $V_{PreFT} < V_{fault}(reset)$ , HR2000 gets into Preheat state from the start up state. During this state, Pre/FT pin's detection function will be disabled. High voltage will be sent out in this state.

During this state, CP/EOL pin will disable EOL detection function and only take the timing function.

In this state, only CS pin has a current limit function. If  $V_{cs} > V_{cs}(pre)$  in a switching period, the FC pin will be discharged by an internal current source IFC(disch) cycle-by-cycle. This controls the working frequency.

### Ignition State

Ignition state follows preheat state closely. In this state, EOL protection and CS(pre) limit are disabled. FC voltage increases which results in frequency decreasing. Then the voltage on lamp gets higher and higher to ignite the lamp.

CP/EOL pin also only takes timing function in this state. Once preheat state is over, Pre/FT pin is dropped to  $V_{fault}(reset2)$ , and then the detection function is active. If Pre/FT pin  $V_{PreFT} > V_{fault}(ref)$  & low side drive is high, then HR2000 will consider it is fault state.

After preheat state, CS pin over current protection is active and limits CS voltage (power stage current).

When  $V_{cs} > V_{cs}(clamp)$  @ low side drive=high, the impedance of CS pin will become very small and a current flows into this pin. The koc of this current will charge the CT pin to increase frequency. The low side MOSFET will be turned off quickly while high side MOSFET will not be affected. This results in a narrow turn on time of low side MOSFET and a relatively larger turn on time of high side MOSFET. This asymmetric operation of half bridge limits the output power.

### Burn state

After ignition state, Burn state is entered. At the beginning of burn state, CP/EOL pin will be dropped to the middle level of the EOL detection

window  $V_{eol}(middle)$ . Then the EOL detection function is active instead of the timing function.

Voltage on FC pin will continue to increase until it reaches a clamping level. CS pin over current protection mentioned in ignition state is still used to limit CS voltage (power stage current).

### Protection

In oscillation state, the half-bridge protection includes:

- EOL protection
- Capacitive mode protection
- Current limit
- VCC low protection
- Over temperature protection

### EOL protection

'End of Life'(EOL) protection is enabled after CP/EOL is dropped to  $V_{eol}(middle)$ . There is a window comparator for this protection. If the voltage on CP/EOL pin get out of  $V_{eol}(low) \sim V_{eol}(high)$ , then the current source  $I_{fault}(ch)$  will charge the capacitor at Pre/FT pin. If  $V_{PreFT} > V_{fault}(ref)$ , then HR2000 will get into fault state.

This protection is disabled in PFC  $V_o$ -low state.

### Capacitive mode protection

The capacitive mode protection is active during all oscillating states. It is detected by the voltage on CS at the moment of turning on of low side MOSFET. If at this moment,  $V_{cs} > V_{cs}(cap)$ , then capacitive mode is confirmed and FC pin is discharged at this switching cycle. VFC will decrease towards zero which means the maximum frequency if the capacitive mode always exists. If capacitive mode @  $f_{max}$  is detected, then  $I_{fault}(ch)$  is activated to charge the capacitor at Pre/FT pin.

### Current limit

The current limit is realized on CS pin. There are three kinds of limitation on CS pin.

$V_{cs}(pre)$  in preheat state;

$V_{cs}(clamp)$  of over current protection function in oscillating states;

Capacitive protection in oscillating states.

They have been described in the related states above.

**VCC low protection**

It is mentioned in VCC under voltage state.

**Over temperature protection (OTP)**

It is described in OTP state.

**PFC part**

In the typical application, PFC can be defined to 3 states:

- Normal state;
- VO-low state;
- OVC state;

**Normal state**

PFC works at boundary conduction mode (BCM) with Ton control. Fig3 shows the internal block.

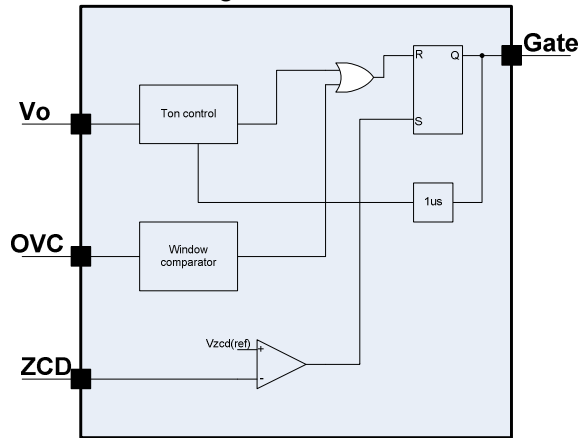

Figure 3— PFC part block

The Ton is set by the voltage at Vo pin. Higher Vvo, shorter Ton. The circuit in Fig1 shows the example. ZCD pin detects the inductor current zero-crossing point. When The Vzcd<Vzcdref, Gate will be high and the external MOSFET will be turned on.

In the range of Vvo(low)~Vvo(off), Ton varies linearly from Ton(max) to zero. When Vvo>Vvo(off), Ton is zero, and GATE pin is low.

The minimum turn off time is set internally to 1.4µs.

**Vo-low state**

In case of main voltage too low, PFC may not maintain its intended output voltage. In order to keep on working, the current sunk into Vo pin is monitored. If it is lower than Ivo(low) the IC will get into Vo-low state.

In Vo-low state:

There is a current Ifault(disch) to discharge Pre/FT pin. This can increase the protection level. EOL protection is disabled.

Vovc<Vovc(low) will overrule Vo-low condition.

**OVC state**

OVC pin monitors PFC output voltage and Boost PFC MOSFET current. Fig1 shows the example. If Vovc>Vovcref or Vovc<Vovclow, then PFC will stop immediately.

Vovclow is set to prevent the absence of PFC output detection.



## APPLICATION INFORMATION

### PFC Part

#### Setting the PFC Output Voltage

The Vo pin is used to set the PFC output voltage. Connect a resistor (R105, R106, R107 in figure 1) between the PFC output and Vo pin, its value is set by:

$$R_{PFC\_OUT} = \frac{V_{O\_PFC} - 2V}{I_{VO(REF)}}$$

Where  $I_{VO(REF)}=102\mu A$  is the reference sink current through Vo pin.

Connect a capacitor in range of  $0.47\mu F$  to  $10\mu F$  (C103 in figure 1) or a R-C-C network from Vo pin to GND to compensate the PFC regulation loop.

#### Setting the Over Voltage and Over Current Protection

The OVC pin is used for the over voltage and over current protection for the PFC stage. Connect this pin to the voltage divider (R108, R109, R110 and R102 in figure 1) of the PFC output to set the over voltage protection point.

$$\frac{R_{OV\_H}}{R_{OV\_L}} = \frac{V_{o\_PFC\_pro}}{V_{OVC(REF)}}$$

Where  $V_{OVC(REF)}=1.26V$  is the OVC protection threshold voltage, and  $V_{o\_PFC\_pro}$  is protection point of the PFC output voltage.  $R_{OV\_H}$  is the upper side resistor of the divider and  $R_{OV\_L}$  is the low side resistor of the voltage divider.

The over current protection senses the peak current through the PFC MOSFET. the sensing resistor (R101 in figure 1) is set by:

$$R_{oc} = \frac{V_{OVC(REF)} + V_{f\_diode}}{I_{oc}}$$

Where  $V_{f\_diode}\approx 0.7V$  is the forward voltage of the diode (D107 in figure 1), and  $I_{oc}$  is the over current protection point.

#### Setting the ZCD Detection

An auxiliary winding of the PFC inductor is used to sense the voltage across the inductor to indicate the zero inductor current condition. Set the turn ratio of the auxiliary winding large

enough to make sure the reflected voltage across the auxiliary winding is higher than the ZCD reference voltage  $V_{zcdref}$ . Usually, setting the reflected ZCD voltage at around 5V at maximum input voltage is recommended.

A zener diode is integrated on ZCD pin. Add a resistor in  $10k\Omega$  to  $100k\Omega$  range between the auxiliary winding and the ZCD pin to limit the current sunk into ZCD pin, according to the input voltage range.

### Half Bridge Part

#### Setting the Oscillator of Half Bridge

The capacitor on CT pin (C201 in figure 1) and the resistor on REF pin (R201 in figure 1) determine the bottom operating frequency. The resistor on REF pin also determines the non-overlap time of the half bridge.

Estimate the frequency set resistor on REF pin with the desired non-overlap time:

$$T_{no} = 0.15 + 1.127 \times \frac{R_{REF}}{51k\Omega} (\mu s)$$

Note that the  $R_{REF}$  resistor should not exceed the range in the limiting values.

Choose a proper capacitor on CT pin to set the bottom operating frequency.

$$f_B = \frac{0.5}{2(R_{REF} + R_{int}) * (C_T + C_{par}) + 300ns}$$

Where  $C_T$  is the capacitor on CT pin,  $R_{int}=0.3k\Omega$  is the internal parasitic resistance on REF pin and  $C_{par}=5pF$  is the internal parasitic capacitance on CT pin. Choose a proper capacitor on CT pin and then redesign the resistor on REF pin to make sure the bottom operating frequency is accurate.

The start up frequency is:

$$f_{ST} = \frac{0.5}{\frac{2.5V \times (C_T + C_{par})}{2.5V} + 300ns + \frac{35\mu A}{2(R_{REF} + R_{int})}}$$

#### Setting the Preheat time and Ignition Time

The capacitor on CP/EOL pin (C203) and the resistor on REF pin determine the preheat time and ignition time.

$$T_{\text{preheat}} = 600 \times \frac{C_{\text{CP}}}{100\text{nF}} \times \frac{R_{\text{REF}}}{51\text{k}\Omega} (\text{ms})$$

$$T_{\text{ignition}} = 562 \times \frac{C_{\text{CP}}}{100\text{nF}} \times \frac{R_{\text{REF}}}{51\text{k}\Omega} (\text{ms})$$

### Setting the Preheat Current Limitation

In the preheat stage, the CS pin limits the preheat current through the filament of the FL. The preheat current is limited by setting the sense resistor on CS pin (R202 in figure 1) through:

$$I_{\text{preheat\_pk}} = \frac{V_{\text{CS(pre)}}}{R_{\text{CS}}}$$

Where the  $V_{\text{CS(pre)}}=410\text{mV}$  is the threshold voltage of CS pin to limit the preheat current.

If using the filament transformer for preheating, this CS pin function will limit the resonant current in the preheat stage.

The over current limitation function on CS pin limits the ignition voltage or ignition current in the ignition state and any exceeded output current/power condition. Add a diode (D203 in figure 1) like 1N4148 in parallel with the sense resistor and a 1k resistor (R203 in figure 1) between the CS pin and the current sense resistor to limit the negative voltage on CS pin.

### Design the PFC Inductor

The HR2000 operates the PFC in boundary conduction mode (BCM) with on-time ( $T_{\text{on}}$ ) control. The frequency of the PFC stage is variable. The design of the PFC inductor relates to the output power, the range of the input AC voltage and the desired minimum operating frequency. It is also limited by the maximum turn on time of HR2000. The maximum peak current through this inductor is:

$$I_{\text{L\_pk\_max}} = \frac{2\sqrt{2}P_{\text{o\_max}}}{\eta \times V_{\text{in\_min\_RMS}}}$$

Where  $\eta$  is the efficiency of the PFC stage, usually in range of 0.95 to 0.98.

The maximum turn on time of the PFC MOSFET occurs at the minimum AC input voltage:

$$T_{\text{on\_max}} = \frac{L \times I_{\text{L\_pk\_max}}}{\sqrt{2}V_{\text{in\_min\_RMS}}} = \frac{L \times 2P_{\text{o\_max}}}{\eta \times V_{\text{in\_min\_RMS}}^2}$$

Then the inductor is restricted by the maximum on time limit of IC:

$$L \leq \frac{\eta \times V_{\text{in\_min\_RMS}}^2 \times T_{\text{on\_limit}}}{2P_{\text{o\_max}}}$$

Where  $T_{\text{on\_limit}}$  is the IC's limit for maximum on time, design its value with  $20\mu\text{s}$ .

The minimum operating frequency occurs at the minimum AC input voltage or the maximum AC input voltage.

$$f_{\text{min}} = \min\left(\frac{\sqrt{2}V_{\text{in\_min\_RMS}} \times (V_{\text{o}} - \sqrt{2}V_{\text{in\_min\_RMS}})}{L \times V_{\text{o}} \times I_{\text{L\_pk\_max}}}, \frac{\sqrt{2}V_{\text{in\_max\_RMS}} \times (V_{\text{o}} - \sqrt{2}V_{\text{in\_max\_RMS}})}{L \times V_{\text{o}} \times I_{\text{L\_pk\_max}}}\right)$$

For most of the specifications, such as the universal input (85VAC to 265VAC) and 400V PFC output, the minimum frequency occurs at the maximum AC input voltage.

Design the inductor value with the desired minimum operating frequency, and it should be in the restricted range by the IC's limit of the maximum on time.

### Application Example

This application example introduces the design of a 16W FL based on HR2000. It requires the PF (power factor) over 0.9. The boost PFC stage and resonant half bridge power structure is used for this FL driver. The integrated PFC control and half bridge driver of HR2000 fits for this type of application well.

**Specification:**

Parameter	Symbol	Condition	Min	Typ	Max	Units
Input Supply Voltage	$V_{in}$	2 Wire	198		264	VAC
AC Line Frequency	$f_{LINE}$		47	50	63	Hz
Lamp Voltage	$V_{lamp}$			55		Vrms
Lamp Current	$I_{lamp}$			0.29		A
Output Lamp Power	$P_{lamp}$			16		W
Preheat Current	$I_{pre}$		0.18		0.3	A
Preheat time	$t_{pre}$	Rref=51k, CCP=100nF		674		ms
Ignition time	$t_{ign}$	Rref=51k, CCP=100nF		611		ms
Open circuit voltage	$V_{oc}$	$t < t_e$		270		Vrms
	$V_{oc}$	$t > t_e$		300		Vrms
Burning mode frequency	$f_{run}$			44.6		kHz
Efficiency (Full Load)	$\eta$		80			%
Line regulation						%
Startup time	$t_{ST}$			1		s
Conducted EMI			Meets EN55015B			
Power Factor			90			%
Harmonics			Meets IEC61000-3-2 Class C			
Ambient Temperature	TAMB	Free convection, sea level			40	□

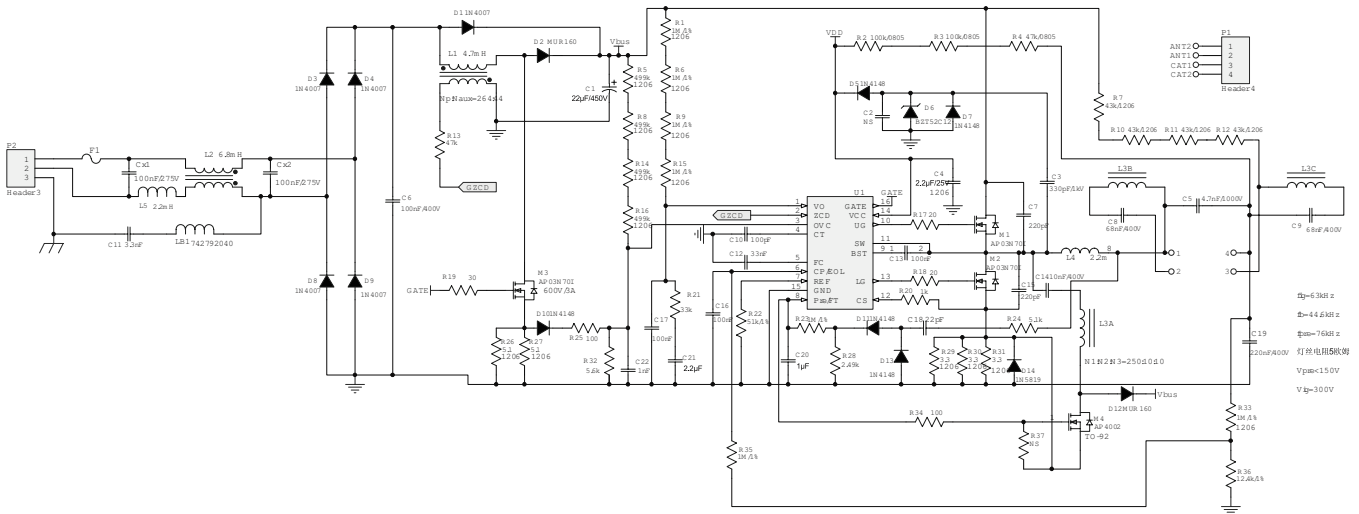
**Schematic:**

**Figure 4—HR2000 FL Driver for 16W Lamp**
**Design Procedure:**

Please refer to the application note of HR2000 for the design procedure.

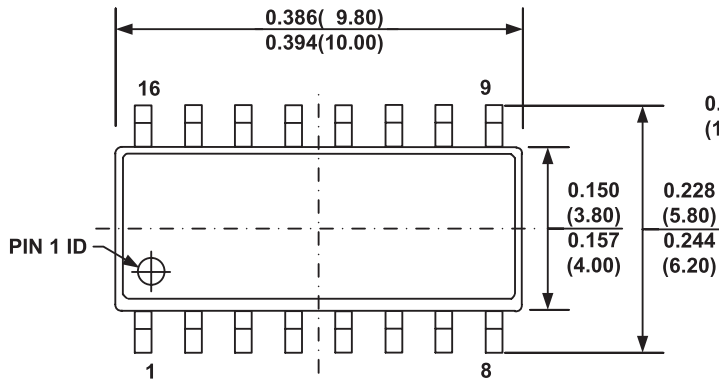
**SOIC16**

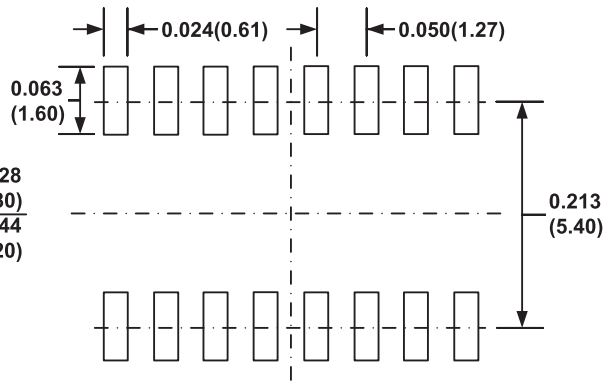

**TOP VIEW**



**RECOMMENDED LAND PATTERN**

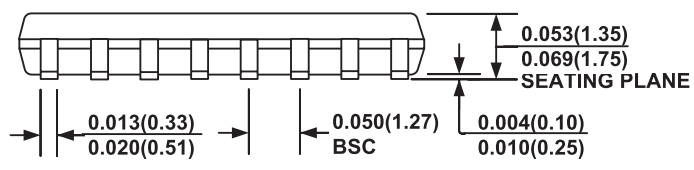

**FRONT VIEW**

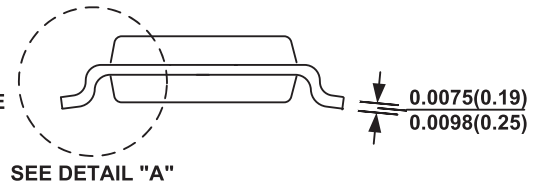

**SIDE VIEW**

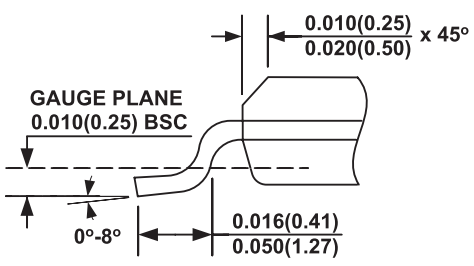

**DETAIL "A"**

**NOTE:**

- 1) CONTROL DIMENSION IS IN INCHES. DIMENSION IN BRACKET IS IN MILLIMETERS.
- 2) PACKAGE LENGTH DOES NOT INCLUDE MOLD FLASH, PROTRUSIONS OR GATE BURRS.
- 3) PACKAGE WIDTH DOES NOT INCLUDE INTERLEAD FLASH OR PROTRUSIONS.
- 4) LEAD COPLANARITY (BOTTOM OF LEADS AFTER FORMING) SHALL BE 0.004" INCHES MAX.
- 5) DRAWING CONFORMS TO JEDEC MS-012, VARIATION AC.
- 6) DRAWING IS NOT TO SCALE.

**NOTICE:** The information in this document is subject to change without notice. Users should warrant and guarantee that third party Intellectual Property rights are not infringed upon when integrating MPS products into any application. MPS will not assume any legal responsibility for any said applications.



Компания «ЭлектроПласт» предлагает заключение долгосрочных отношений при поставках импортных электронных компонентов на взаимовыгодных условиях!

Наши преимущества:

- Оперативные поставки широкого спектра электронных компонентов отечественного и импортного производства напрямую от производителей и с крупнейших мировых складов;
- Поставка более 17-ти миллионов наименований электронных компонентов;
- Поставка сложных, дефицитных, либо снятых с производства позиций;
- Оперативные сроки поставки под заказ (от 5 рабочих дней);
- Экспресс доставка в любую точку России;
- Техническая поддержка проекта, помощь в подборе аналогов, поставка прототипов;
- Система менеджмента качества сертифицирована по Международному стандарту ISO 9001;
- Лицензия ФСБ на осуществление работ с использованием сведений, составляющих государственную тайну;
- Поставка специализированных компонентов (Xilinx, Altera, Analog Devices, Intersil, Interpoint, Microsemi, Aeroflex, Peregrine, Syfer, Eurofarad, Texas Instrument, Miteq, Cobham, E2V, MA-COM, Hittite, Mini-Circuits, General Dynamics и др.);

Помимо этого, одним из направлений компании «ЭлектроПласт» является направление «Источники питания». Мы предлагаем Вам помощь Конструкторского отдела:

- Подбор оптимального решения, техническое обоснование при выборе компонента;
- Подбор аналогов;
- Консультации по применению компонента;
- Поставка образцов и прототипов;
- Техническая поддержка проекта;
- Защита от снятия компонента с производства.



#### Как с нами связаться

**Телефон:** 8 (812) 309 58 32 (многоканальный)

**Факс:** 8 (812) 320-02-42

**Электронная почта:** [org@eplast1.ru](mailto:org@eplast1.ru)

**Адрес:** 198099, г. Санкт-Петербург, ул. Калинина, дом 2, корпус 4, литера А.