

Connector: RP-SMA Jack (Male Pin)			
Termination: PCB Edge Mount, 0.062" Thick			
Part Number	CONREVSMA003.062	CONREVSMA003.062-G	
Connector Part	Material	Finish	Finish
Bodies	Body: Brass	Nickel	Gold
Center Contact	Pin: Brass	Gold	Gold
Insulator	PTFE	-	-

REVISIONS			
REV	DESCRIPTION	DATE	APPV
A	INITIAL RELEASE OF LINX INTERNAL DRAWING	01/MAR/19	CLL

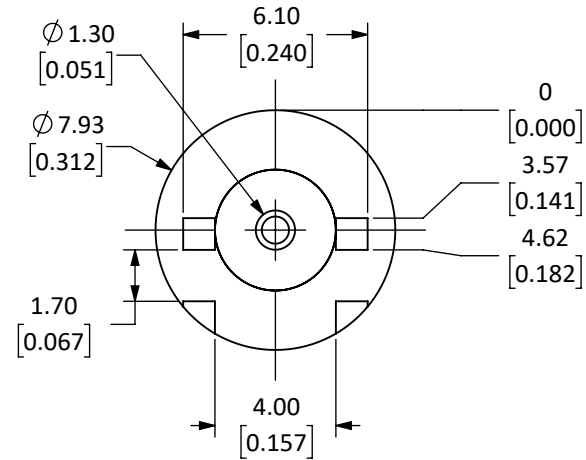
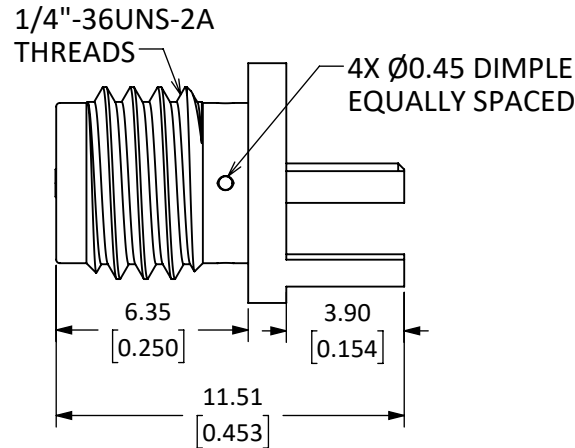

NOTES: (UNLESS OTHERWISE SPECIFIED)

1. ALL DIMENSIONS ARE IN mm [INCHES].
2. DIMENSIONS APPLY AFTER FINISHING.
3. MANUFACTURE TO BE COMPLIANT WITH EU RoHS DIRECTIVE, USE MATERIALS THAT DO NOT CONTAIN REACH SUBSTANCES OF VERY HIGH CONCERN >1000ppm, AND USE DRC CONFLICT-FREE SOURCED MATERIALS.
4. SAFETY BREAK ALL SHARP CORNERS AND EDGES 0.5 MAXIMUM.
5. SEE TABLE I FOR ELECTRICAL SPECIFICATIONS. (SHEET 2)
6. SEE TABLE II FOR ENVIRONMENTAL SPECIFICATIONS. (SHEET 2)
7. SEE TABLE III FOR MECHANICAL SPECIFICATIONS. (SHEET 2)
8. SEE PARTSLIST. "\*" INDICATES FINISH TYPE.

**WARNING:** THIS DRAWING CONTAINS PROPRIETARY INFORMATION THAT IS THE SOLE PROPERTY OF LINX TECHNOLOGIES, AND SHALL BE TREATED AS SUCH. NO DISCLOSURE OR REPRODUCTION OF THIS DOCUMENT IS PERMITTED, IN WHOLE OR IN PART, WITHOUT THE EXPRESS WRITTEN PERMISSION OF LINX TECHNOLOGIES OR ITS DESIGNATED AGENTS.

MATERIAL:	TOLERANCES: 0.50 [.020]-5.00 [.200]= ±0.20 [.008] 5.00 [.200]-30.00 [1.200]= ±0.40 [.016] 30.0 [1.20]-120.0 [4.75]= ±0.60 [0.24] 120.0 [4.75]-315.0 [12.40]= ±1.0 [.040]	PROJECTION: 
FINISH:	DRAWN: M. SCHULTE	DT: 21/JAN/19
	ENGR: D. VARATHARAJAN	DT: 08/MAR/19

<b>Linx</b>		159 ORT LANE MERLIN, OR 97532	
TITLE: RP-SMA FEMALE EDGE MOUNT FOR 0.062" THICK BOARD			
SIZE	DWG. NO.	REV	
<b>A</b>	CONREVSMA003.062-*	<b>A</b>	
SCALE: 4:1	DO NOT SCALE DRAWING	SHEET 1 OF 2	

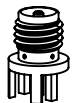

SCALE 1 : 1

**5** TABLE I

Electrical Data	Detail
Impedance	50 Ω
Frequency Range	0 to 18 GHz
Insulation Resistance	5 000 M Ω min.
Voltage Rating	500 V RMS
Contact Resistance	Center: ≤ 2.0 mΩ Outer: ≤ 2.0 mΩ
VSWR	≤ 1.2 : 1 @ 6 GHz

**6** TABLE II

Environmental Data	Detail
Corrosion (Salt spray)	ASTM B-117
Thermal Shock	MIL-STD-202 Method 107 test condition B
Vibration	MIL-STD-202 Method 204 test condition D
Mechanical Shock	MIL-STD-202 Method 213 test condition I
Temperature Range	-65 °C to +165 °C
Environmental Compliance	RoHS

**7** TABLE III

Mechanical Data	Detail
Mounting Type	PCB Board Edge, End Launch
Fastening Type	1/4"-36 Threaded Coupling
Recommended Torque	0.57 N·m (5.0 in·lbs)
Coupling Nut Retention	60 lbs. min.
Connector Durability	500 cycles min.
Weight	1.24 g (0.04 oz)

SEE SHEET 1 FOR REVISIONS

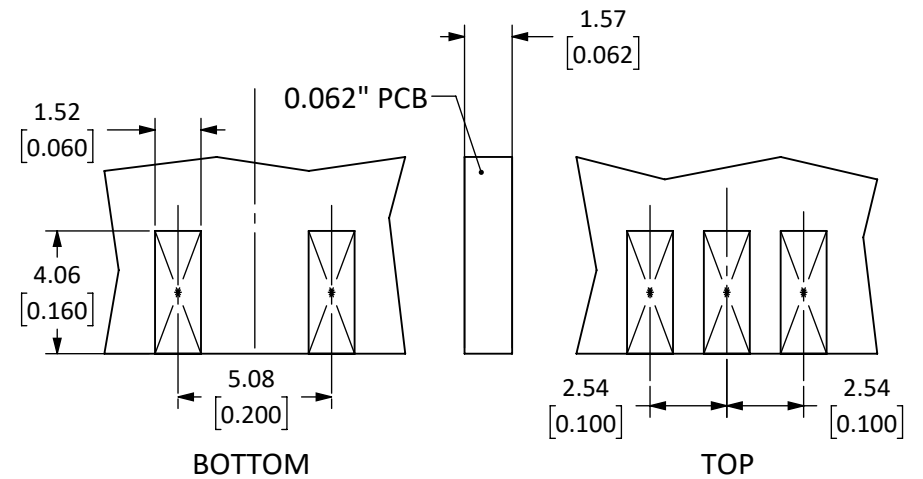

RECOMMENDED FOOTPRINT

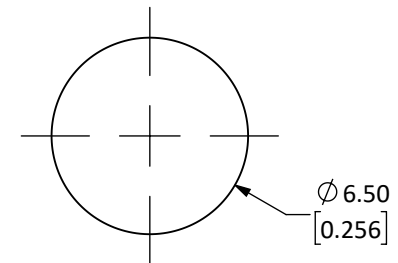

RECOMMENDED MOUNTING HOLE

SIZE	DWG. NO.	REV
<b>A</b>	CONREVSMA003.062-*	<b>A</b>
SCALE: 4:1	DO NOT SCALE DRAWING	SHEET 2 OF 2

## Reflow Soldering

Reflow soldering is the most common method of attaching surface mount electronic components to a circuit board. The goal of the reflow process is to melt the solder and heat the conductive surfaces, without overheating or damaging any electrical components. In the conventional reflow soldering process, there are four distinct stages, or zones, having specific thermal profiles: preheat, thermal soak, reflow, and cooling. For high-volume assembly, surface mount components are generally auto-placed by machine.

## Reflow Temperature Profile

The single most critical stage in the automated assembly process is the reflow stage. The reflow profile for any given component should be closely followed because excessive temperatures or transport times during reflow can irreparably damage the component. Assembly personnel need to pay careful attention to the oven's profile to ensure that it meets the requirements necessary to successfully reflow all components while still remaining within the limits mandated by components requiring shorter flow periods.

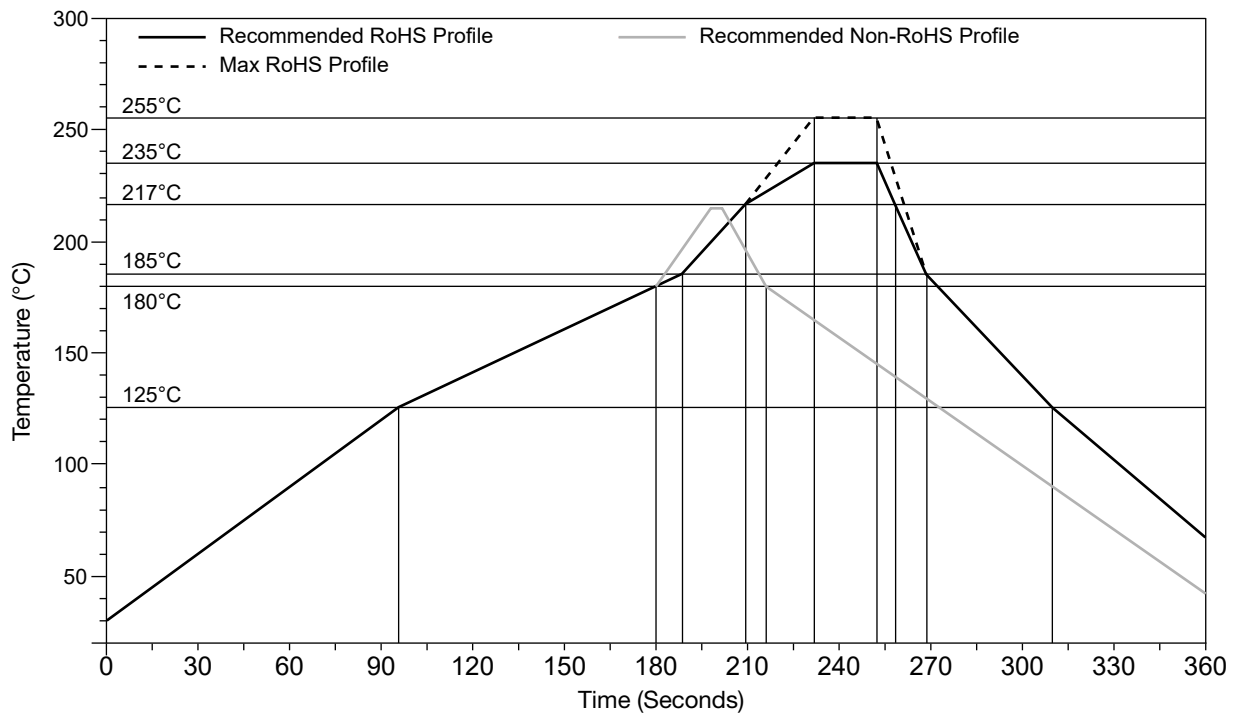



Компания «ЭлектроПласт» предлагает заключение долгосрочных отношений при поставках импортных электронных компонентов на взаимовыгодных условиях!

Наши преимущества:

- Оперативные поставки широкого спектра электронных компонентов отечественного и импортного производства напрямую от производителей и с крупнейших мировых складов;
- Поставка более 17-ти миллионов наименований электронных компонентов;
- Поставка сложных, дефицитных, либо снятых с производства позиций;
- Оперативные сроки поставки под заказ (от 5 рабочих дней);
- Экспресс доставка в любую точку России;
- Техническая поддержка проекта, помощь в подборе аналогов, поставка прототипов;
- Система менеджмента качества сертифицирована по Международному стандарту ISO 9001;
- Лицензия ФСБ на осуществление работ с использованием сведений, составляющих государственную тайну;
- Поставка специализированных компонентов (Xilinx, Altera, Analog Devices, Intersil, Interpoint, Microsemi, Aeroflex, Peregrine, Syfer, Eurofarad, Texas Instrument, Miteq, Cobham, E2V, MA-COM, Hittite, Mini-Circuits, General Dynamics и др.);

Помимо этого, одним из направлений компании «ЭлектроПласт» является направление «Источники питания». Мы предлагаем Вам помощь Конструкторского отдела:

- Подбор оптимального решения, техническое обоснование при выборе компонента;
- Подбор аналогов;
- Консультации по применению компонента;
- Поставка образцов и прототипов;
- Техническая поддержка проекта;
- Защита от снятия компонента с производства.



#### Как с нами связаться

**Телефон:** 8 (812) 309 58 32 (многоканальный)

**Факс:** 8 (812) 320-02-42

**Электронная почта:** [org@eplast1.ru](mailto:org@eplast1.ru)

**Адрес:** 198099, г. Санкт-Петербург, ул. Калинина, дом 2, корпус 4, литера А.