



Features

- Incremental encoder / quadrature output
- Exceptionally long operating life
- Sturdy construction
- Bushing mount
- Available with PC board mounting bracket (optional)
- RoHS compliant*

ECW - Digital Contacting Encoder

Electrical Characteristics

| | |
|--|--|
| Output..... | 2-bit quadrature code, Channel A leads Channel B by 90 ° electrically turning clockwise (CW) |
| Closed Circuit Resistance..... | 5 ohms maximum |
| Open Circuit Resistance..... | 100 K ohms minimum |
| Contact Rating..... | 10 milliamp @ 10 VDC or 0.1 watt maximum |
| Insulation Resistance (500 VDC)..... | 1,000 megohms minimum |
| Dielectric Withstanding Voltage (MIL-STD-202 Method 301) | |
| Sea Level..... | 1,000 VAC minimum |
| Electrical Travel..... | Continuous |
| Contact Bounce (15 RPM)..... | 5 milliseconds maximum |
| RPM (Operating)..... | 120 maximum |
| Phase Tolerance (CH A to CH B)..... | 90 ° ± 72 ° |

Environmental Characteristics

| | |
|----------------------------------|---------------------------------------|
| Operating Temperature Range..... | -40 °C to +85 °C (-40 °F to 185 °F) |
| Storage Temperature Range..... | -40 °C to +85 °C (-40 °F to +185 °F) |
| Humidity..... | MIL-STD-202, Method 103B, Condition B |
| Vibration..... 15 G | |
| Contact Bounce..... | 0.1 millisecond maximum |
| Shock..... 50 G | |
| Contact Bounce..... | 0.1 millisecond maximum |
| Rotational Life..... | 200,000 shaft revolutions |
| IP Rating..... | IP 40 |

Mechanical Characteristics

| | |
|-------------------------------------|---|
| Mechanical Angle..... | Continuous |
| Running Torque (Detented)..... | 0.5 to 1.5 N-cm (0.75 to 2.25 oz-in.) |
| Undetented Torque..... | 0.17 to 1.0 N-cm (0.25 to 1.50 oz-in.) |
| Mounting Torque..... | 79 N-cm (7 lb.-in.) maximum |
| Shaft Side Load (Static)..... | 4.5 kg (10 lbs.) minimum |
| Weight..... | Approximately 21 gms. (0.75 oz.) |
| Terminals..... PC pin or solder lug | |
| Soldering Condition | |
| Manual Soldering..... | 96.5Sn/3.0Ag/0.5Cu solid wire or no-clean rosin cored wire 370 °C (700 °F) max. for 3 seconds |
| Wave Soldering..... | 96.5Sn/3.0Ag/0.5Cu solder with no-clean flux 260 °C (500 °F) max. for 5 seconds |
| Wash processes..... | Not recommended |
| Marking..... | Manufacturer's name and trademark, part number, and date code. |
| Hardware..... | One lockwasher and one mounting nut are shipped with each encoder, except where noted in the part number. |

Quadrature Output Table – This table is intended to show available outputs as currently defined.

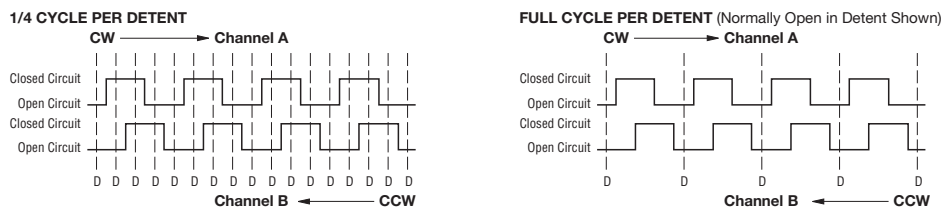

RECOMMENDED INCREMENTAL CONTROL DIAGRAM FOR USE WITH A DEBOUNCE CIRCUIT

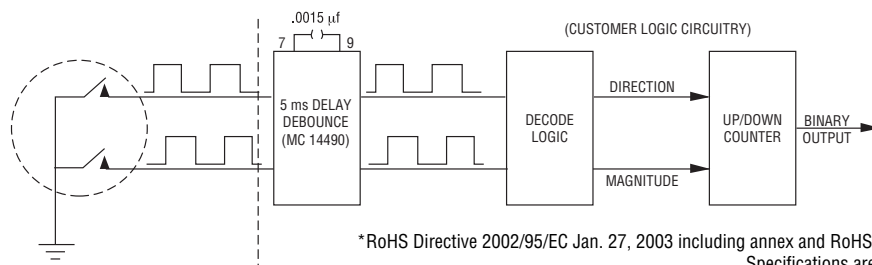

*RoHS Directive 2002/95/EC Jan. 27, 2003 including annex and RoHS Recast 2011/65/EU June 8, 2011.

Specifications are subject to change without notice.

The device characteristics and parameters in this data sheet can and do vary in different applications and actual device performance may vary over time. Users should verify actual device performance in their specific applications.

ECW - Digital Contacting Encoder

BOURNS®

Dimensional Drawings

BUSHING MOUNTED - HOUSING A Rear-Facing Terminals

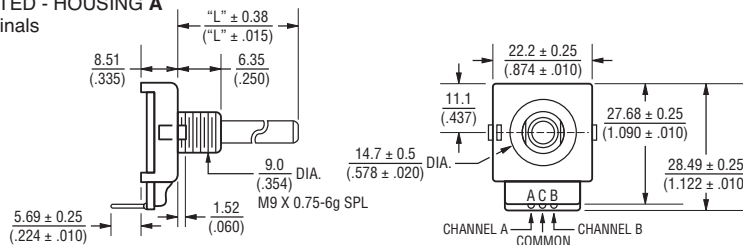

PANEL HOLE DIMENSIONS Bushing Mounted

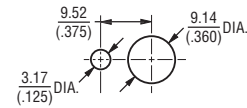

PCB BRACKET MOUNTED - HOUSING B Dimensions not given are the same as Bushing Mounted.

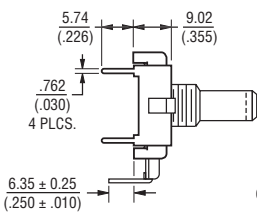

PCB MOUNTING DIMENSIONS (Housing Styles B and E)

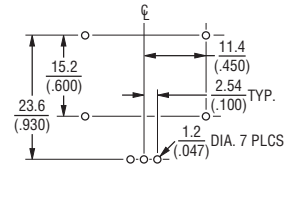

SOLDER HOLES - HOUSING C

Dimensions not given are the same as Bushing Mounted.

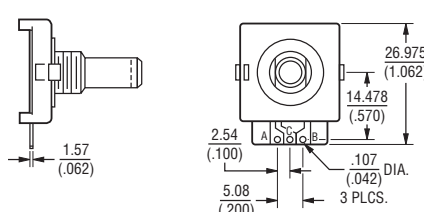

SNAP-IN MOUNT - Housing G

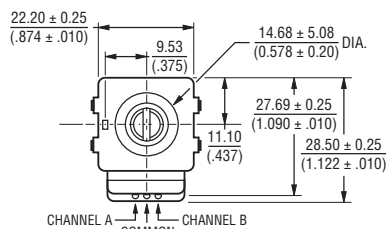
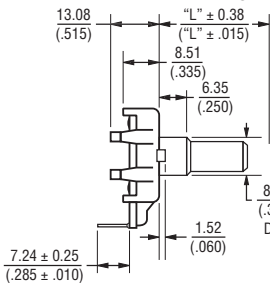

PCB MOUNTING DIMENSIONS

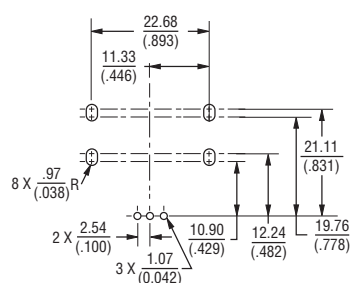

Shaft Style B

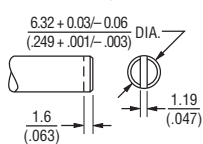

Shaft Style C

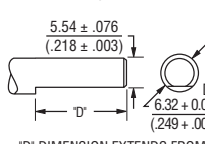

"D" DIMENSION EXTENDS FROM SHAFT END TO BUSHING FACE
 "D" = (SHAFT LENGTH, FMS) - (BUSHING LENGTH)

Shaft Style J

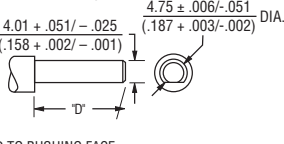

Shaft Style R

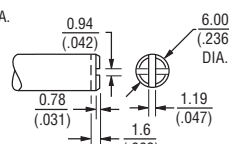

Shaft Style Y

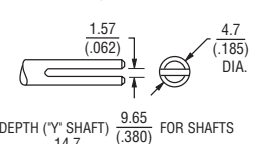

BUSHING MOUNTED - HOUSING H Front-Facing Terminals

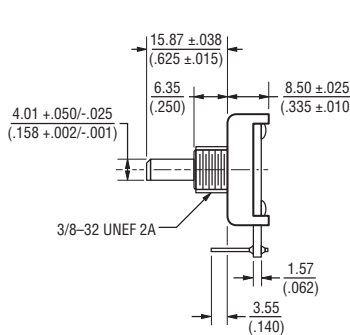
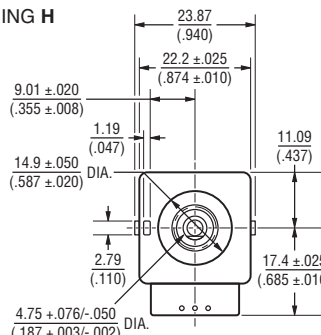
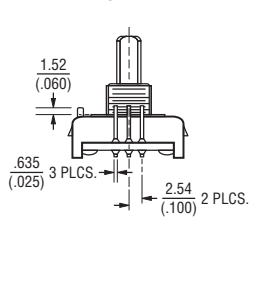

FOR TOLERANCES NOT SHOWN
 .XX ± .25 (.010), .XXX ± .13 (.005)
 SHAFT DIMENSIONS ± 1/32"
 DIMENSIONS: MM (IN)

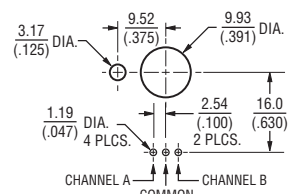

Specifications are subject to change without notice.

The device characteristics and parameters in this data sheet can and do vary in different applications and actual device performance may vary over time. Users should verify actual device performance in their specific applications.

ECW - Digital Contacting Encoder

BOURNS®

How to Order

PART NUMBERING SYSTEM

E C W 1 J - B 2 4 - B C 0 0 2 4 L

| Code | Rotational Life |
|------|---------------------|
| C | 200,000 Revolutions |

| BUSHING CONFIGURATION | |
|-----------------------|--|
| Code | Description |
| W | 9 mm x 1/4 " Length. Threaded M9x0.75 |
| L | 9 mm x 3/8 " Length. Threaded M9x0.75 (Use B shaft only.) |
| T | 9 mm x 1/4 ". No Thread. |

| SWITCHING CONFIGURATION (In Detent Position) | |
|--|----------------|
| Applies to performance codes B0012 and C0024 only, use code "0" for all other performance codes. | |
| Code | Description |
| 0 | Not Applicable |
| 1 | Normally Open |

| ANTI-ROTATION LUG POSITION | |
|----------------------------|---------------|
| Code | Description |
| J | 9:00 Position |
| D | None |

| SHAFT STYLE (See Outline Drawing for Details) | |
|---|---------------------------------------|
| Code | Description |
| B | Plain with Inserted Slot (1/4 " Dia.) |
| C | Single Flatted (1/4 " Dia.) |
| R | Plain with Cross Slot (6 mm Dia.) |
| Y | Split Shaft Version (.185 " Dia.) |
| J | Flatted Shaft (3/16 " Dia.) |

| RoHS IDENTIFIER | |
|-----------------|-------------|
| Code | Description |
| L | Compliant |

| PERFORMANCE CODE | | |
|------------------|---------|-------------|
| Code | Detents | Cycles/Rev. |
| E0006 | 0 | 6 |
| E0009 | 0 | 9 |
| E0012 | 0 | 12 |
| E0024 | 0 | 24 |
| E0036 | 0 | 36 |
| B0012 | 12 | 12 |
| C0006 | 24 | 6 |
| C0024 | | 24 |
| D0009 | 36 | 9 |

| HOUSING TERMINAL CONFIGURATION (X indicates "Equipped With") | | | | | | | | | | |
|---|---|---|---|---|---|---|----|---|---|---|
| Code | | | | | | | | | | |
| Features | A | B | C | D | E | F | G* | H | K | |
| Terminal Cover | X | X | | | X | | X | | | |
| Rear-Facing Terminals | X | X | | | X | | X | | | |
| Solder Holes | | | X | X | | X | | | | |
| PCB Bracket | | X | | X | X | X | | | | |
| Hardware Included | X | | X | | X | X | | X | | |
| Snap-In Mount | | | | | | | | X | | |
| Forward-Facing Terminals | | | | | | | | | X | X |

*Bushing code T only.

| SHAFT LENGTH (FMS) | | |
|--------------------|-----------------------------|------------------------|
| Code | Description | Available Shaft Styles |
| 16 | 1/2 " Length | B |
| 20 | 5/8 " (15.9 mm) Length | J |
| 24 | 3/4 " (19 mm) Length | B, C, J, Y |
| 28 | 7/8 " (22.2 mm) Length | B, C, J, Y |
| 32 | 1 " (25.4 mm) Length | B, C, J, Y |
| 36 | 1-1/8 " (28.6 mm) Length | B, C, J, Y |
| Metric | | |
| 19 | 19 mm Length | R |
| 22 | 22 mm Length | R |
| 24 | 24 mm Length | R |

The sample part number demonstrates the identification code for Bourns contacting encoders.

Boldface features are Bourns standard options. All others are available with higher minimum order quantities.

REV. 02/13

Specifications are subject to change without notice. The device characteristics and parameters in this data sheet can and do vary in different applications and actual device performance may vary over time. Users should verify actual device performance in their specific applications.



Компания «ЭлектроПласт» предлагает заключение долгосрочных отношений при поставках импортных электронных компонентов на взаимовыгодных условиях!

Наши преимущества:

- Оперативные поставки широкого спектра электронных компонентов отечественного и импортного производства напрямую от производителей и с крупнейших мировых складов;
- Поставка более 17-ти миллионов наименований электронных компонентов;
- Поставка сложных, дефицитных, либо снятых с производства позиций;
- Оперативные сроки поставки под заказ (от 5 рабочих дней);
- Экспресс доставка в любую точку России;
- Техническая поддержка проекта, помощь в подборе аналогов, поставка прототипов;
- Система менеджмента качества сертифицирована по Международному стандарту ISO 9001;
- Лицензия ФСБ на осуществление работ с использованием сведений, составляющих государственную тайну;
- Поставка специализированных компонентов (Xilinx, Altera, Analog Devices, Intersil, Interpoint, Microsemi, Aeroflex, Peregrine, Syfer, Eurofarad, Texas Instrument, Miteq, Cobham, E2V, MA-COM, Hittite, Mini-Circuits, General Dynamics и др.);

Помимо этого, одним из направлений компании «ЭлектроПласт» является направление «Источники питания». Мы предлагаем Вам помощь Конструкторского отдела:

- Подбор оптимального решения, техническое обоснование при выборе компонента;
- Подбор аналогов;
- Консультации по применению компонента;
- Поставка образцов и прототипов;
- Техническая поддержка проекта;
- Защита от снятия компонента с производства.



Как с нами связаться

Телефон: 8 (812) 309 58 32 (многоканальный)

Факс: 8 (812) 320-02-42

Электронная почта: org@eplast1.ru

Адрес: 198099, г. Санкт-Петербург, ул. Калинина, дом 2, корпус 4, литера А.