



## MIC5335

Dual, High Performance  
300mA  $\mu$ Cap ULDO™

### General Description

The MIC5335 is a high current density, dual Ultra Low Dropout (ULDO™) linear regulator. The MIC5335 is ideally suited for portable electronics which demand overall high performance in a very small form factor. The MIC5335 is offered in the ultra small 1.6mm x 1.6mm x 0.55mm 6-ld Thin MLF® package, which is only 2.56mm<sup>2</sup> in area. The MIC5335 delivers exceptional thermal performance for those applications that demand higher power dissipation in a very small foot print. In addition, the MIC5335 integrates two high performance 300mA LDOs with independent enable functions and offers high PSRR eliminating the need for a bypass capacitor.

The MIC5335 is a  $\mu$ Cap design which enables operation with very small output capacitors for stability, thereby reducing required board space and component cost.

The MIC5335 is available in fixed-output voltages. Additional voltages are available. For more information, contact Micrel's Marketing department.

Data sheets and support documentation can be found on Micrel's web site at: [www.micrel.com](http://www.micrel.com).

### Features

- 2.3V to 5.5V input voltage range
- Ultra-low dropout voltage: 75mV at 300mA
- Ultra Small 1.6mm x 1.6mm x 0.55mm 6 lead MLF® package
- Independent enable pins
- High PSRR > 65dB @ 1kHz
- 300mA output current per LDO
- $\mu$ Cap Stable with 1 $\mu$ F ceramic capacitor
- Low quiescent current: 90 $\mu$ A/LDO
- Fast turn-on time: 30 $\mu$ s
- Thermal Shutdown Protection
- Current Limit Protection

### Applications

- Mobile Phones
- PDAs
- GPS Receivers
- Portable electronics
- Portable media players
- Digital still and video cameras

### Typical Application

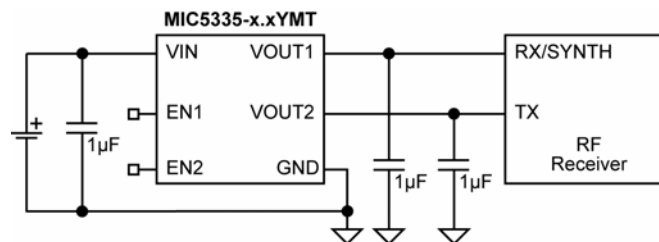

ULDO is a trademark of Micrel, Inc.

MLF and MicroLead Frame are registered trademarks of Amkor Technologies.

Micrel Inc. • 2180 Fortune Drive • San Jose, CA 95131 • USA • tel +1 (408) 944-0800 • fax +1 (408) 474-1000 • <http://www.micrel.com>

### MIC5335 Block Diagram

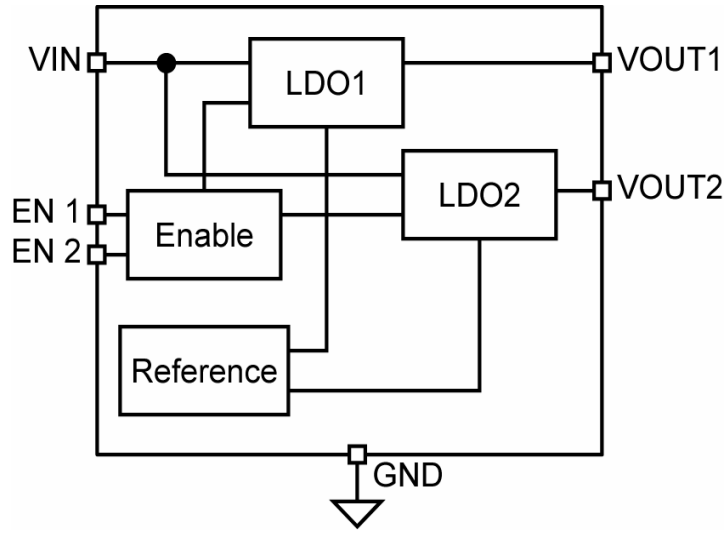

## Ordering Information

Part number	Manufacturing Part Number	Marking	Voltage*	Junction Temp. Range	Package
MIC5335-1.8/1.5YMT	MIC5335-GFYMT	GPF	1.8V/1.5V	-40°C to +125°C	6-Pin 1.6x1.6 Thin MLF <sup>®</sup>
MIC5335-1.8/1.6YMT	MIC5335-GWYMT	GPW	1.8V/1.6V	-40°C to +125°C	6-Pin 1.6x1.6 Thin MLF <sup>®</sup>
MIC5335-1.8/1.8YMT	MIC5335-GGYMT	GPG	1.8V/1.8V	-40°C to +125°C	6-Pin 1.6x1.6 Thin MLF <sup>®</sup>
MIC5335-2.5/1.8YMT	MIC5335-JGYMT	JPG	2.5V/1.8V	-40°C to +125°C	6-Pin 1.6x1.6 Thin MLF <sup>®</sup>
MIC5335-2.5/2.5YMT	MIC5335-JJYMT	JPJ	2.5V/2.5V	-40°C to +125°C	6-Pin 1.6x1.6 Thin MLF <sup>®</sup>
MIC5335-2.6/1.85YMT	MIC5335-KDYMT	KPD	2.6V/1.85	-40°C to +125°C	6-Pin 1.6x1.6 Thin MLF <sup>®</sup>
MIC5335-2.6/1.8YMT	MIC5335-KGYMT	KPG	2.6V/1.8V	-40°C to +125°C	6-Pin 1.6x1.6 Thin MLF <sup>®</sup>
MIC5335-2.7/2.7YMT	MIC5335-LLYMT	LPL	2.7V/2.7V	-40°C to +125°C	6-Pin 1.6x1.6 Thin MLF <sup>®</sup>
MIC5335-2.8/1.5YMT	MIC5335-MFYMT	MPF	2.8V/1.5V	-40°C to +125°C	6-Pin 1.6x1.6 Thin MLF <sup>®</sup>
MIC5335-2.8/1.8YMT	MIC5335-MGYMT	MPG	2.8V/1.8V	-40°C to +125°C	6-Pin 1.6x1.6 Thin MLF <sup>®</sup>
MIC5335-2.8/2.6YMT	MIC5335-MKYMT	MPK	2.8V/2.6V	-40°C to +125°C	6-Pin 1.6x1.6 Thin MLF <sup>®</sup>
MIC5335-2.8/2.8YMT	MIC5335-MMYMT	MPM	2.8V/2.8V	-40°C to +125°C	6-Pin 1.6x1.6 Thin MLF <sup>®</sup>
MIC5335-2.85/1.85YMT	MIC5335-NDYMT	NPD	2.85V/1.85V	-40°C to +125°C	6-Pin 1.6x1.6 Thin MLF <sup>®</sup>
MIC5335-2.85/2.6YMT	MIC5335-NKYMT	NPK	2.85V/2.6V	-40°C to +125°C	6-Pin 1.6x1.6 Thin MLF <sup>®</sup>
MIC5335-2.85/2.85YMT	MIC5335-NNYMT	NPN	2.85V/2.85V	-40°C to +125°C	6-Pin 1.6x1.6 Thin MLF <sup>®</sup>
MIC5335-2.9/1.5YMT	MIC5335-OFYMT	OPF	2.9V/1.5V	-40°C to +125°C	6-Pin 1.6x1.6 Thin MLF <sup>®</sup>
MIC5335-2.9/1.8YMT	MIC5335-OGYMT	OPG	2.9V/1.8V	-40°C to +125°C	6-Pin 1.6x1.6 Thin MLF <sup>®</sup>
MIC5335-2.9/2.9YMT	MIC5335-OOYMT	OPO	2.9V/2.9V	-40°C to +125°C	6-Pin 1.6x1.6 Thin MLF <sup>®</sup>
MIC5335-3.0/1.8YMT	MIC5335-PGYMT	PPG	3.0V/1.8V	-40°C to +125°C	6-Pin 1.6x1.6 Thin MLF <sup>®</sup>
MIC5335-3.0/2.5YMT	MIC5335-PJYMT	PPJ	3.0V/2.5V	-40°C to +125°C	6-Pin 1.6x1.6 Thin MLF <sup>®</sup>
MIC5335-3.0/2.6YMT	MIC5335-PKYMT	PPK	3.0V/2.6V	-40°C to +125°C	6-Pin 1.6x1.6 Thin MLF <sup>®</sup>
MIC5335-3.0/2.8YMT	MIC5335-PMYMT	PPM	3.0V/2.8V	-40°C to +125°C	6-Pin 1.6x1.6 Thin MLF <sup>®</sup>
MIC5335-3.0/2.85YMT	MIC5335-PNYMT	PPN	3.0V/2.85V	-40°C to +125°C	6-Pin 1.6x1.6 Thin MLF <sup>®</sup>
MIC5335-3.0/3.0YMT	MIC5335-PPYMT	PPP	3.0V/3.0V	-40°C to +125°C	6-Pin 1.6x1.6 Thin MLF <sup>®</sup>
MIC5335-3.3/1.5YMT	MIC5335-SFYMT	SPF	3.3V/1.5V	-40°C to +125°C	6-Pin 1.6x1.6 Thin MLF <sup>®</sup>
MIC5335-3.3/1.8YMT	MIC5335-SGYMT	SPG	3.3V/1.8V	-40°C to +125°C	6-Pin 1.6x1.6 Thin MLF <sup>®</sup>
MIC5335-3.3/2.5YMT	MIC5335-SJYMT	SPJ	3.3V/2.5V	-40°C to +125°C	6-Pin 1.6x1.6 Thin MLF <sup>®</sup>
MIC5335-3.3/2.6YMT	MIC5335-SKYMT	SPK	3.3V/2.6V	-40°C to +125°C	6-Pin 1.6x1.6 Thin MLF <sup>®</sup>
MIC5335-3.3/2.7YMT	MIC5335-SLYMT	SPL	3.3V/2.7V	-40°C to +125°C	6-Pin 1.6x1.6 Thin MLF <sup>®</sup>
MIC5335-3.3/2.8YMT	MIC5335-SMYMT	SPM	3.3V/2.8V	-40°C to +125°C	6-Pin 1.6x1.6 Thin MLF <sup>®</sup>
MIC5335-3.3/2.85YMT	MIC5335-SNYMT	SPN	3.3V/2.85V	-40°C to +125°C	6-Pin 1.6x1.6 Thin MLF <sup>®</sup>
MIC5335-3.3/2.9YMT	MIC5335-SOYMT	SPO	3.3V/2.9V	-40°C to +125°C	6-Pin 1.6x1.6 Thin MLF <sup>®</sup>
MIC5335-3.3/3.0YMT	MIC5335-SPYMT	SPP	3.3V/3.0V	-40°C to +125°C	6-Pin 1.6x1.6 Thin MLF <sup>®</sup>
MIC5335-3.3/3.2YMT	MIC5335-SRYMT	SPR	3.3V/3.2V	-40°C to +125°C	6-Pin 1.6x1.6 Thin MLF <sup>®</sup>
MIC5335-3.3/3.3YMT	MIC5335-SSYMT	SPS	3.3V/3.3V	-40°C to +125°C	6-Pin 1.6x1.6 Thin MLF <sup>®</sup>

**Note:**

\* For other voltages available. Contact Micrel Marketing for details.

## Pin Configuration

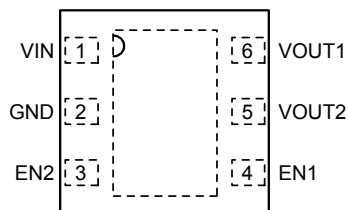

**6-pin 1.6mm × 1.6mm Thin MLF<sup>®</sup>**  
Top View

## Pin Description

Pin Number Thin MLF-6	Pin Name	Pin Function
1	VIN	Supply Input.
2	GND	Ground
3	EN2	Enable Input (regulator 2). Active High Input. Logic High = On; Logic Low = Off; Do not leave floating.
4	EN1	Enable Input (regulator 1). Active High Input. Logic High = On; Logic Low = Off; Do not leave floating.
5	VOUT2	Regulator Output – LDO2
6	VOUT1	Regulator Output – LDO1
HS Pad	EPAD	Exposed heatsink pad connected to ground internally.

**Absolute Maximum Ratings<sup>(1)</sup>**

Supply Voltage ( $V_{IN}$ ).....	0V to +6V
Enable Input Voltage ( $V_{EN}$ ).....	0V to +6V
Power Dissipation.....	Internally Limited <sup>(3)</sup>
Lead Temperature (soldering, 3sec.....)	260°C
Storage Temperature ( $T_S$ ).....	-65°C to +150°C
ESD Rating <sup>(4)</sup> .....	2kV

**Operating Ratings<sup>(2)</sup>**

Supply voltage ( $V_{IN}$ ).....	+2.3V to +5.5V
Enable Input Voltage ( $V_{EN}$ ).....	0V to $V_{IN}$
Junction Temperature .....	-40°C to +125°C
Junction Thermal Resistance	
Thin MLF <sup>®</sup> -6 ( $\theta_{JA}$ ) .....	100°C/W

**Electrical Characteristics<sup>(5)</sup>**

$V_{IN} = EN1 = EN2 = V_{OUT} + 1.0V$ ; higher of the two regulator outputs,  $I_{OUTLDO1} = I_{OUTLDO2} = 100\mu A$ ;  $C_{OUT1} = C_{OUT2} = 1\mu F$ ;  $T_J = 25^\circ C$ , **bold** values indicate  $-40^\circ C \leq T_J \leq +125^\circ C$ , unless noted.

Parameter	Conditions	Min	Typ	Max	Units
Output Voltage Accuracy	Variation from nominal $V_{OUT}$	-2.0		+2.0	%
	Variation from nominal $V_{OUT}$ ; $-40^\circ C$ to $+125^\circ C$	<b>-3.0</b>		<b>+3.0</b>	%
Line Regulation	$V_{IN} = V_{OUT} + 1V$ to 5.5V; $I_{OUT} = 100\mu A$		0.02	0.3 <b>0.6</b>	%/V %/V
Load Regulation	$I_{OUT} = 100\mu A$ to 300mA		0.3	<b>2.0</b>	%
Dropout Voltage ( <b>Note 6</b> )	$I_{OUT} = 100\mu A$		0.1		mV
	$I_{OUT} = 100mA$		25	<b>75</b>	mV
	$I_{OUT} = 150mA$		35	<b>100</b>	mV
	$I_{OUT} = 300mA$		75	<b>200</b>	mV
Ground Current	EN1 = High; EN2 = Low; $I_{OUT} = 100\mu A$ to 300mA		90	<b>125</b>	$\mu A$
	EN1 = Low; EN2 = High; $I_{OUT} = 100\mu A$ to 300mA		90	<b>125</b>	$\mu A$
	EN1 = EN2 = High; $I_{OUT1} = 300mA$ , $I_{OUT2} = 300mA$		150	<b>220</b>	$\mu A$
Ground Current in Shutdown	EN1 = EN2 = 0V		0.01	2	$\mu A$
Ripple Rejection	$f = 1kHz$ ; $C_{OUT} = 1.0\mu F$		65		dB
	$f = 20kHz$ ; $C_{OUT} = 1.0\mu F$		45		
Current Limit	$V_{OUT} = 0V$	<b>340</b>	550	<b>950</b>	mA
Output Voltage Noise	$C_{OUT} = 1.0\mu F$ ; 10Hz to 100kHz		90		$\mu V_{RMS}$
<b>Enable Inputs (EN1 / EN2)</b>					
Enable Input Voltage	Logic Low			<b>0.2</b>	V
	Logic High	<b>1.1</b>			V
Enable Input Current	$V_{IL} \leq 0.2V$		0.01	1	$\mu A$
	$V_{IH} \geq 1.0V$		0.01	1	$\mu A$
<b>Turn-on Time (See Timing Diagram)</b>					
Turn-on Time (LDO1 and 2)	$C_{OUT} = 1.0\mu F$		30	<b>100</b>	$\mu s$

**Notes:**

- Exceeding the absolute maximum rating may damage the device.
- The device is not guaranteed to function outside its operating rating.
- The maximum allowable power dissipation of any  $T_A$  (ambient temperature) is  $P_{D(max)} = (T_{J(max)} - T_A) / \theta_{JA}$ . Exceeding the maximum allowable power dissipation will result in excessive die temperature, and the regulator will go into thermal shutdown.
- Devices are ESD sensitive. Handling precautions recommended. Human body model, 1.5k in series with 100pF.
- Specification for packaged product only.
- Dropout voltage is defined as the input-to-output differential at which the output voltage drops 2% below its nominal  $V_{OUT}$ . For outputs below 2.3V, the dropout voltage is the input-to-output differential with the minimum input voltage 2.3V.

# Typical Characteristics

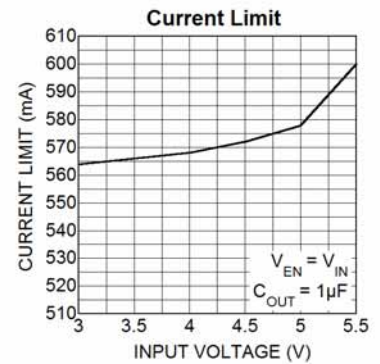
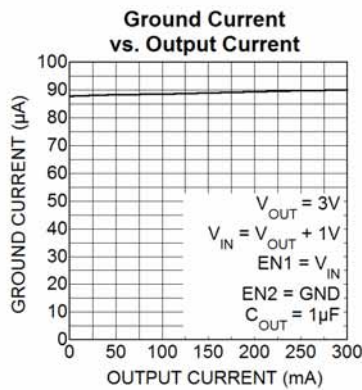
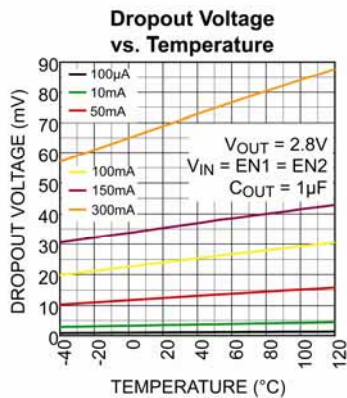
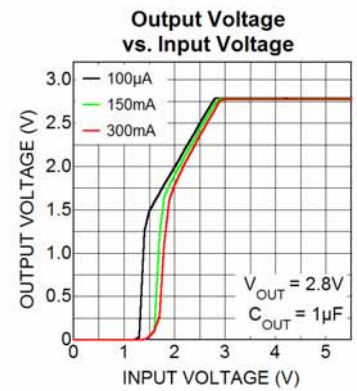
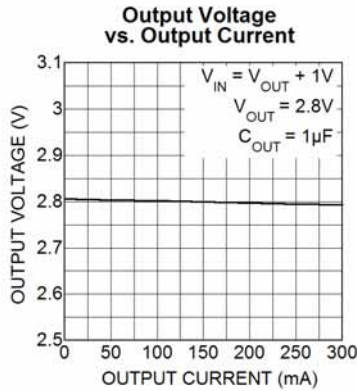
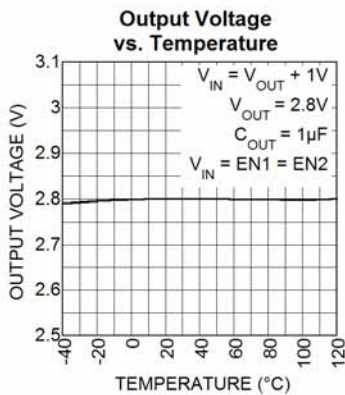
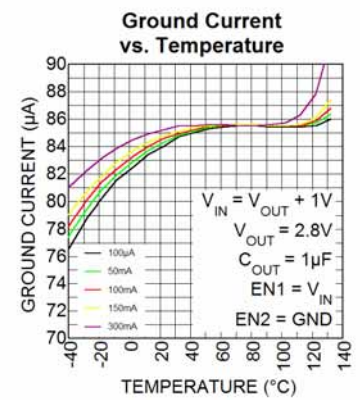
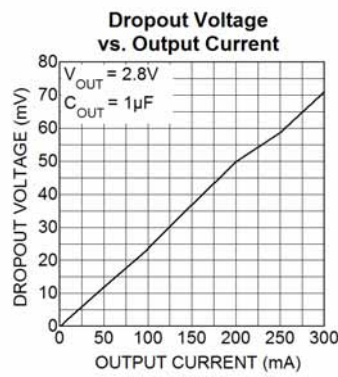
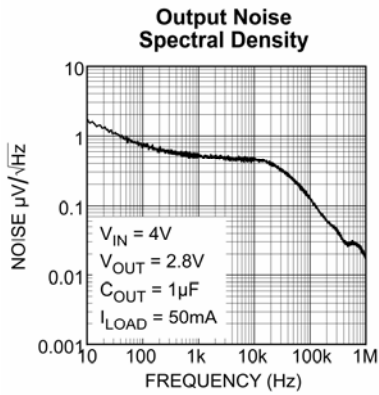

### Functional Characteristics

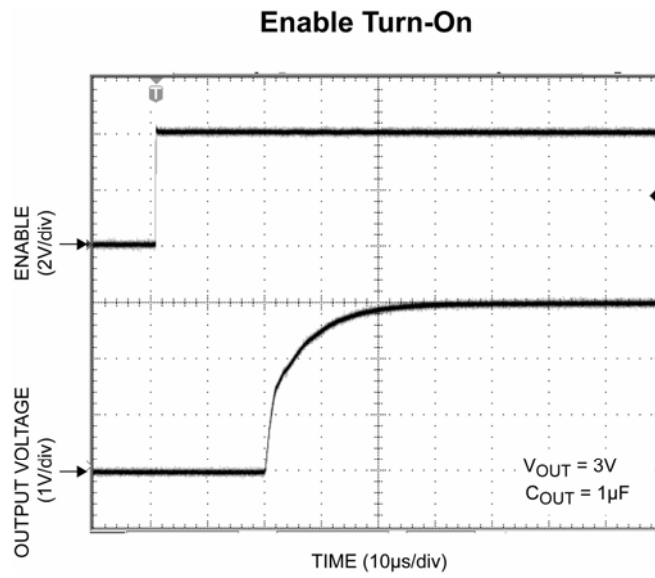
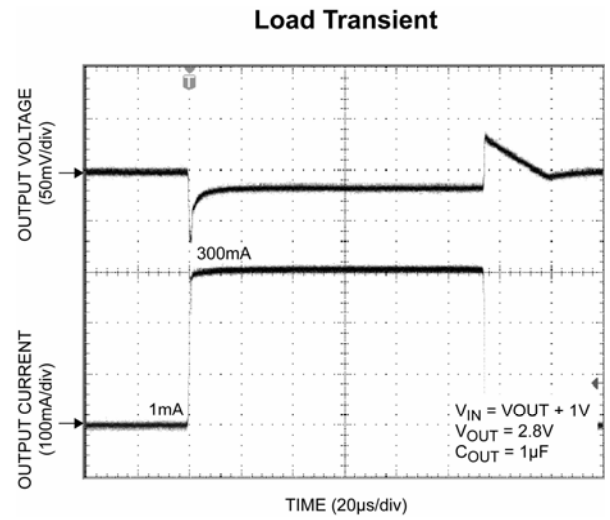
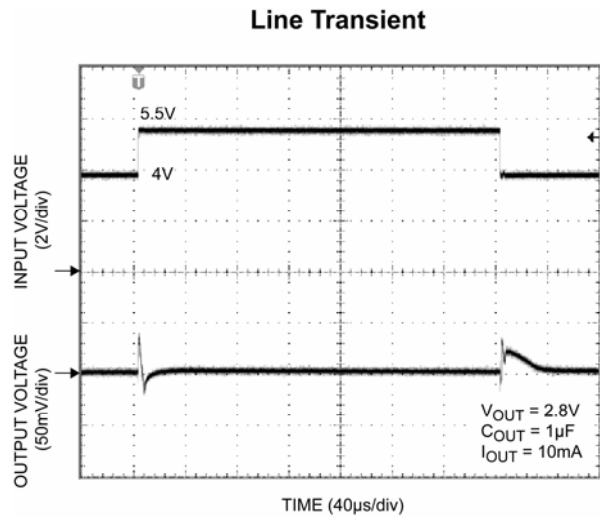

## Applications Information

### Enable/Shutdown

The MIC5335 comes with dual active-high enable pins that allow each regulator to be enabled independently. Forcing the enable pin low disables the regulator and sends it into a “zero” off-mode-current state. In this state, current consumed by the regulator goes nearly to zero. Forcing the enable pin high enables the output voltage. The active-high enable pin uses CMOS technology and the enable pin cannot be left floating; a floating enable pin may cause an indeterminate state on the output.

### Input Capacitor

The MIC5335 is a high-performance, high bandwidth device. Therefore, it requires a well-bypassed input supply for optimal performance. A 1 $\mu$ F capacitor is required from the input-to-ground to provide stability. Low-ESR ceramic capacitors provide optimal performance at a minimum of space. Additional high-frequency capacitors, such as small-valued NPO dielectric-type capacitors, help filter out high-frequency noise and are good practice in any RF-based circuit.

### Output Capacitor

The MIC5335 requires an output capacitor of 1 $\mu$ F or greater to maintain stability. The design is optimized for use with low-ESR ceramic chip capacitors. High ESR capacitors may cause high frequency oscillation. The output capacitor can be increased, but performance has been optimized for a 1 $\mu$ F ceramic output capacitor and does not improve significantly with larger capacitance.

X7R/X5R dielectric-type ceramic capacitors are recommended because of their temperature performance. X7R-type capacitors change capacitance by 15% over their operating temperature range and are the most stable type of ceramic capacitors on the market. Z5U and Y5V dielectric capacitors change value by as much as 50% and 60%, respectively, over their operating temperature ranges. To use a ceramic chip capacitor with Y5V dielectric, the value must be much higher than an X7R ceramic capacitor to ensure the same minimum capacitance over the equivalent operating temperature range.

### No-Load Stability

Unlike many other voltage regulators, the MIC5335 will remain stable and in regulation with no load. This is especially important in CMOS RAM keep-alive applications.

## Thermal Considerations

The MIC5335 is designed to provide 300mA of continuous current for both outputs in a very small package. Maximum ambient operating temperature can be calculated based upon the output current and the voltage drop across the part. Given that the input voltage is 3.3V, the output voltage is 2.8V for  $V_{OUT1}$ , 2.5V for  $V_{OUT2}$  and the output current = 300mA. The actual power dissipation of the regulator circuit can be determined using the equation:

$$P_D = (V_{IN} - V_{OUT1}) I_{OUT1} + (V_{IN} - V_{OUT2}) I_{OUT2} + V_{IN} I_{GND}$$

Because this device is CMOS and the ground current is typically <100 $\mu$ A over the load range, the power dissipation contributed by the ground current is < 1% and can be ignored for this calculation.

$$P_D = (3.3V - 2.8V) \times 300mA + (3.3V - 2.5V) \times 300mA$$

$$P_D = 0.39W$$

To determine the maximum ambient operating temperature of the package, use the junction-to-ambient thermal resistance of the device and the following basic equation:

$$P_{D(max)} = \left( \frac{T_{J(max)} - T_A}{\theta_{JA}} \right)$$

$T_{J(max)} = 125^\circ\text{C}$ , the maximum junction temperature of the die  $\theta_{JA}$  thermal resistance = 100 $^\circ\text{C/W}$ .

The table that follows shows junction-to-ambient thermal resistance for the MIC5335 in the Thin MLF<sup>®</sup> package.

Package	$\theta_{JA}$ Recommended Minimum Footprint	$\theta_{JC}$
6-Pin 1.6 X1.6 Thin MLF <sup>™</sup>	100 $^\circ\text{C/W}$	2 $^\circ\text{C/W}$

### Thermal Resistance

Substituting  $P_D$  for  $P_{D(max)}$  and solving for the ambient operating temperature will give the maximum operating conditions for the regulator circuit. The junction-to-ambient thermal resistance for the minimum footprint is 100 $^\circ\text{C/W}$ .

The maximum power dissipation must not be exceeded for proper operation.

For example, when operating the MIC5335-MFYML at an input voltage of 3.3V and 300mA loads on each output with a minimum footprint layout, the maximum ambient operating temperature  $T_A$  can be determined as follows:

$$0.39W = (125^\circ\text{C} - T_A)/(100^\circ\text{C/W})$$



$T_A=86^{\circ}\text{C}$

Therefore, a 2.8V/2.5V application with 300mA at each output current can accept an ambient operating temperature of 86°C in a 1.6mm x 1.6mm Thin MLF<sup>®</sup> package. For a full discussion of heat sinking and

thermal effects on voltage regulators, refer to the “Regulator Thermals” subsection of *Micrel’s Designing with Low-Dropout Voltage Regulators* handbook. This information can be found on Micrel’s website at:  
[http://www.micrel.com/\\_PDF/other/LDOBk\\_ds.pdf](http://www.micrel.com/_PDF/other/LDOBk_ds.pdf)

**Package Information**

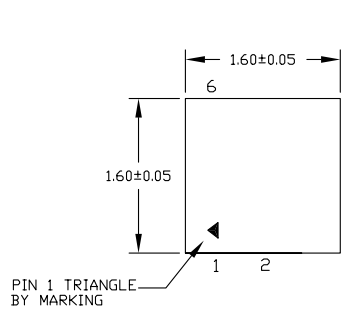

TOP VIEW

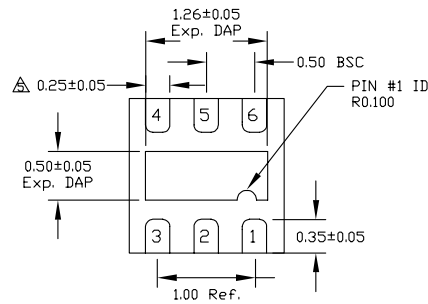

BOTTOM VIEW

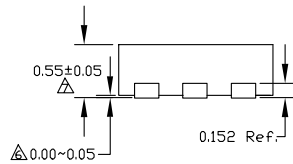

SIDE VIEW

- NOTE:
1. ALL DIMENSIONS ARE IN MILLIMETERS.
  2. MAX. PACKAGE WARPAGE IS 0.05 mm.
  3. MAXIMUM ALLOWABLE BURRS IS 0.075 mm IN ALL DIRECTIONS.
  4. PIN #1 ID ON TOP WILL BE LASER/INK MARKED.
- △ DIMENSION APPLIES TO METALIZED TERMINAL AND IS MEASURED BETWEEN 0.20 AND 0.25 mm FROM TERMINAL TIP.  
 △ APPLIED ONLY FOR TERMINALS.  
 △ APPLIED FOR EXPOSED PAD AND TERMINALS.

**6-Pin 1.6mm x 1.6mm Thin MLF<sup>®</sup> (MT)**

**MICREL, INC. 2180 FORTUNE DRIVE SAN JOSE, CA 95131 USA**  
 TEL +1 (408) 944-0800 FAX +1 (408) 474-1000 WEB <http://www.micrel.com>

The information furnished by Micrel in this data sheet is believed to be accurate and reliable. However, no responsibility is assumed by Micrel for its use. Micrel reserves the right to change circuitry and specifications at any time without notification to the customer.

Micrel Products are not designed or authorized for use as components in life support appliances, devices or systems where malfunction of a product can reasonably be expected to result in personal injury. Life support devices or systems are devices or systems that (a) are intended for surgical implant into the body or (b) support or sustain life, and whose failure to perform can be reasonably expected to result in a significant injury to the user. A Purchaser's use or sale of Micrel Products for use in life support appliances, devices or systems is a Purchaser's own risk and Purchaser agrees to fully indemnify Micrel for any damages resulting from such use or sale.

© 2006 Micrel, Inc.

# Mouser Electronics

Authorized Distributor

Click to View Pricing, Inventory, Delivery & Lifecycle Information:

## Micrel:

[MIC5335-OGYMT TR](#) [MIC5335-KGYMT TR](#) [MIC5335-SJYMT TR](#) [MIC5335-MGYMT TR](#) [MIC5335-SPYMT TR](#)  
[MIC5335-SMYMT TR](#) [MIC5335-PNYMT TR](#) [MIC5335-PJYMT TR](#) [MIC5335-SNYMT TR](#) [MIC5335-NKYMT TR](#)  
[MIC5335-PPYMT TR](#) [MIC5335-JGYMT TR](#) [MIC5335-GGYMT TR](#) [MIC5335-PMYMT TR](#) [MIC5335-SSYMT TR](#)  
[MIC5335-SFYMT TR](#) [MIC5335-KDYMT TR](#) [MIC5335-SLYMT TR](#) [MIC5335-PGYMT TR](#) [MIC5335-SGYMT TR](#)  
[MIC5335-MFYMT TR](#) [MIC5335-LLYMT TR](#) [MIC5335-GFYMT TR](#) [MIC5335-SRYMT TR](#) [MIC5335-SOYMT TR](#)  
[MIC5335-NNYMT TR](#) [MIC5335-SKYMT TR](#) [MIC5335-GWYMT TR](#) [MIC5335-NDYMT TR](#) [MIC5335-PKYMT TR](#)  
[MIC5335-MKYMT TR](#) [MIC5335-MMYMT TR](#) [MIC5335-JJYMT TR](#) [MIC5335-OOYMT TR](#) [MIC5335-OFYMT TR](#)



Компания «ЭлектроПласт» предлагает заключение долгосрочных отношений при поставках импортных электронных компонентов на взаимовыгодных условиях!

Наши преимущества:

- Оперативные поставки широкого спектра электронных компонентов отечественного и импортного производства напрямую от производителей и с крупнейших мировых складов;
- Поставка более 17-ти миллионов наименований электронных компонентов;
- Поставка сложных, дефицитных, либо снятых с производства позиций;
- Оперативные сроки поставки под заказ (от 5 рабочих дней);
- Экспресс доставка в любую точку России;
- Техническая поддержка проекта, помощь в подборе аналогов, поставка прототипов;
- Система менеджмента качества сертифицирована по Международному стандарту ISO 9001;
- Лицензия ФСБ на осуществление работ с использованием сведений, составляющих государственную тайну;
- Поставка специализированных компонентов (Xilinx, Altera, Analog Devices, Intersil, Interpoint, Microsemi, Aeroflex, Peregrine, Syfer, Eurofarad, Texas Instrument, Miteq, Cobham, E2V, MA-COM, Hittite, Mini-Circuits, General Dynamics и др.);

Помимо этого, одним из направлений компании «ЭлектроПласт» является направление «Источники питания». Мы предлагаем Вам помощь Конструкторского отдела:

- Подбор оптимального решения, техническое обоснование при выборе компонента;
- Подбор аналогов;
- Консультации по применению компонента;
- Поставка образцов и прототипов;
- Техническая поддержка проекта;
- Защита от снятия компонента с производства.



#### Как с нами связаться

**Телефон:** 8 (812) 309 58 32 (многоканальный)

**Факс:** 8 (812) 320-02-42

**Электронная почта:** [org@eplast1.ru](mailto:org@eplast1.ru)

**Адрес:** 198099, г. Санкт-Петербург, ул. Калинина, дом 2, корпус 4, литера А.