



---

The following document contains information on Cypress products. Although the document is marked with the name "Spansion" and "Fujitsu", the company that originally developed the specification, Cypress will continue to offer these products to new and existing customers.

#### **Continuity of Specifications**

There is no change to this document as a result of offering the device as a Cypress product. Any changes that have been made are the result of normal document improvements and are noted in the document history page, where supported. Future revisions will occur when appropriate, and changes will be noted in a document history page.

#### **Continuity of Ordering Part Numbers**

Cypress continues to support existing part numbers. To order these products, please use only the Ordering Part Numbers listed in this document.

#### **For More Information**

Please contact your local sales office for additional information about Cypress products and solutions.

#### **About Cypress**

Cypress (NASDAQ: CY) delivers high-performance, high-quality solutions at the heart of today's most advanced embedded systems, from automotive, industrial and networking platforms to highly interactive consumer and mobile devices. With a broad, differentiated product portfolio that includes NOR flash memories, F-RAM™ and SRAM, Traveo™ microcontrollers, the industry's only PSoC® programmable system-on-chip solutions, analog and PMIC Power Management ICs, CapSense® capacitive touch-sensing controllers, and Wireless BLE Bluetooth® Low-Energy and USB connectivity solutions, Cypress is committed to providing its customers worldwide with consistent innovation, best-in-class support and exceptional system value.

# 16-bit Microcontroller

CMOS

## F<sup>2</sup>MC-16LX MB90920 Series

**MB90F922NC/F922NCS/922NCS/F923NC/F923NCS/  
MB90F924NC/F924NCS/V920-101/V920-102**

### ■ DESCRIPTION

The MB90920 series is a family of general-purpose FUJITSU SEMICONDUCTOR 16-bit microcontrollers designed for applications such as vehicle instrument panel control.

The instruction set retains the AT architecture from the F<sup>2</sup>MC-8L and F<sup>2</sup>MC-16LX families, with further refinements including high-level language instructions, extended addressing modes, improved multiplication and division operations (signed), and bit processing. In addition, long word processing is made possible by the inclusion of a built-in 32-bit accumulator.

Note : F<sup>2</sup>MC is the abbreviation of FUJITSU Flexible Microcontroller.

### ■ FEATURES

- Clock  
Built-in PLL clock frequency multiplication circuit.  
Selection of machine clocks (PLL clocks) is allowed among frequency division by two on oscillation clock, and multiplication of 1 to 8 times of oscillation clock (for 4 MHz oscillation clock, 4 MHz to 32 MHz).  
Operation by sub clock (up to 50 kHz : 100 kHz oscillation clock divided by two) is allowed.
- 16-bit input capture (8 channels)  
Detects rising, falling, or both edges.  
16-bit capture register × 8  
The value of a 16-bit free-run timer counter is latched upon detection of an edge input to pin and an interrupt request is generated.

*(Continued)*

For the information for microcontroller supports, see the following web site.

This web site includes the "**Customer Design Review Supplement**" which provides the latest cautions on system development and the minimal requirements to be checked to prevent problems before the system development.

<http://edevice.fujitsu.com/micom/en-support/>

# MB90920 Series

(Continued)

- 16-bit reload timer (4 channels)  
16-bit reload timer operation (select toggle output or one-shot output)  
Selectable event count function
- Real time watch timer (main clock)  
Operates directly from oscillator clock.  
Interrupt can be generated by second/minute/hour/date counter overflow.
- PPG timer (6 channels)  
Output pins (3 channels), external trigger input pin (1 channel)  
Operation clock frequencies :  $f_{CP}$ ,  $f_{CP}/2^2$ ,  $f_{CP}/2^4$ ,  $f_{CP}/2^6$
- Delay interrupt  
Generates interrupt for task switching.  
Interrupts to CPU can be generated/cleared by software setting.
- External interrupts (8 channels)  
8-channel independent operation  
Interrupt source setting available : “L” to “H” edge/ “H” to “L” edge/ “L” level/ “H” level.
- 8/10-bit A/D converter (8 channels)  
Conversion time : 3  $\mu$ s (at  $f_{CP} = 32$  MHz)  
External trigger activation available (P50/INT0/ADTG)  
Internal timer activation available (16-bit reload timer 1)
- UART(LIN/SCI) (4 channels)  
Equipped with full duplex double buffer  
Clock-asynchronous or clock-synchronous serial transfer is available
- CAN interface (4 channels : CAN0 and CAN2, and CAN1 and CAN3 share transmission and reception pins, and interrupt control registers).  
Conforms to CAN specifications version 2.0 Part A and B.  
Automatic resend in case of error.  
Automatic transfer in response to remote frame.  
16 prioritized message buffers for data and ID  
Multiple message support  
Flexible configuration for receive filter : Full bit compare/full bit mask/two partial bit masks  
Supports up to 1 Mbps  
CAN wakeup function (RX connected to INT0 internally)
- LCD controller/driver (32 segment x 4 common)  
Segment driver and command driver with direct LCD panel (display) drive capability
- Reset on detection of low voltage/program loop  
Automatic reset when low voltage is detected  
Program looping detection function
- Stepping motor controller (4 channels)  
High current output for each channel  $\times 4$   
Synchronized 8/10-bit PWM for each channel  $\times 2$
- Sound generator (2 channels)  
8-bit PWM signal mixed with tone frequency from 8-bit reload counter.  
PWM frequencies : 125 kHz, 62.5 kHz, 31.2 kHz, 15.6 kHz (at  $f_{CP} = 32$  MHz)  
Tone frequencies : PWM frequency /2/ , divided by (reload frequency +1)
- Input/output ports  
General-purpose input/output port (CMOS output) 93 ports
- Function for port input level selection  
Automotive/CMOS-Schmitt
- Flash memory security function  
Protects the contents of Flash memory (Flash memory product only)

# MB90920 Series

## ■ PRODUCT LINEUP

Part number Parameter	MB90 F922NC	MB90 F922NCS	MB90 F923NC	MB90 F923NCS	MB90 F924NC	MB90 F924NCS	MB90 922NCS	MB90 V920-101	MB90 V920-102
Type	Flash memory product						MASK ROM product	Evaluation product	
CPU	F <sup>2</sup> MC-16LX CPU								
System clock	PLL clock multiplier circuit (× 1, × 2, × 3, × 4, × 8, 1/2 when PLL stopped) Minimum instruction execution time 31.25 ns (with 4 MHz oscillation clock × 8)								
Sub clock pins (X0A, X1A)	Yes	No	Yes	No	Yes	No	No	No	Yes
ROM	Flash memory 256 Kbytes		Flash memory 384 Kbytes		Flash memory 512 Kbytes		256 K bytes	External	
RAM	10 Kbytes		16 Kbytes		24 Kbytes		10 K bytes	30 Kbytes	
I/O port	91 ports	93 ports	91 ports	93 ports	91 ports	93 ports	93 ports	93 ports	91 ports
LCD controller	32 segment × 4 common								
LIN-UART	UART (LIN/SCI) 4 channels								
CAN interface	4 channels								
16-bit input capture	8 channels								
16-bit reload timer	4 channels								
16-bit free-run timer	1 channel								
Real time watch timer	1 channel								
16-bit PPG timer	6 channels								
External interrupt	8 channels								
8/10-bit A/D converter	8 channels								
Low-voltage/ CPU operating detection reset	Yes						No		
Stepping motor controller	4 channels								
Sound generator	2 channels								
Flash memory security	Yes						—		
Operating voltage	4.0 V to 5.5 V						4.5 V to 5.5 V		
Package	LQFP-120						PGA-299		

# MB90920 Series

## ■ PIN ASSIGNMENT



## ■ PIN DESCRIPTIONS

Pin no.	Pin name	I/O circuit type*1	Function
108	X0	A	High-speed oscillation input pin
107	X1		High-speed oscillation output pin
13	X0A	B	Low-speed oscillation input pin
	P92	I	General-purpose I/O port
14	X1A	B	Low-speed oscillation output pin
	P93	I	General-purpose I/O port
90	$\overline{\text{RST}}$	C	Reset input pin
93	P00	F	General-purpose I/O port
	SEG24		LCD controller/driver segment output pin
94	P01	F	General-purpose I/O port
	SEG25		LCD controller/driver segment output pin
95	P02	F	General-purpose I/O port
	SEG26		LCD controller/driver segment output pin
96	P03	F	General-purpose I/O port
	SEG27		LCD controller/driver segment output pin
97	P04	F	General-purpose I/O port
	SEG28		LCD controller/driver segment output pin
98	P05	F	General-purpose I/O port
	SEG29		LCD controller/driver segment output pin
99	P06	F	General-purpose I/O port
	SEG30		LCD controller/driver segment output pin
100	P07	F	General-purpose I/O port
	SEG31		LCD controller/driver segment output pin
101	P10	I	General-purpose I/O port
	PPG2		16-bit PPG ch.2 output pin
	IN5		Input capture ch.5 trigger input pin
102	P11	I	General-purpose I/O port
	TOT0		16-bit reload timer ch.0 TOT output pin
	PPG3		16-bit PPG ch.3 output pin
	IN4		Input capture ch.4 trigger input pin
103	P12	I	General-purpose I/O port
	TIN0		16-bit reload timer ch.0 TIN input pin
	PPG4		16-bit PPG ch.4 output pin

(Continued)

# MB90920 Series

Pin no.	Pin name	I/O circuit type*1	Function
104	P13	I	General-purpose I/O port
	PPG5		16-bit PPG ch.5 output pin
109	P14	I	General-purpose I/O port
	TIN2		16-bit reload timer ch.2 TIN input pin
	IN1		Input capture ch.1 trigger input pin
110	P15	I	General-purpose I/O port
	IN0		Input capture ch.0 trigger input pin
111	COM0	P	LCD controller/driver common output pin
112	COM1	P	LCD controller/driver common output pin
113	COM2	P	LCD controller/driver common output pin
114	COM3	P	LCD controller/driver common output pin
115	P22	F	General-purpose I/O port
	SEG00		LCD controller/driver segment output pin
116	P23	F	General-purpose I/O port
	SEG01		LCD controller/driver segment output pin
117	P24	F	General-purpose I/O port
	SEG02		LCD controller/driver segment output pin
118	P25	F	General-purpose I/O port
	SEG03		LCD controller/driver segment output pin
119	P26	F	General-purpose I/O port
	SEG04		LCD controller/driver segment output pin
120	P27	F	General-purpose I/O port
	SEG05		LCD controller/driver segment output pin
1	P30	F	General-purpose I/O port
	SEG06		LCD controller/driver segment output pin
2	P31	F	General-purpose I/O port
	SEG07		LCD controller/driver segment output pin
3	P32	F	General-purpose I/O port
	SEG08		LCD controller/driver segment output pin
4	P33	F	General-purpose I/O port
	SEG09		LCD controller/driver segment output pin
5	P34	F	General-purpose I/O port
	SEG10		LCD controller/driver segment output pin
6	P35	F	General-purpose I/O port
	SEG11		LCD controller/driver segment output pin

(Continued)

# MB90920 Series

Pin no.	Pin name	I/O circuit type*1	Function
7	P36	F	General-purpose I/O port
	SEG12		LCD controller/driver segment output pin
8	P37	F	General-purpose I/O port
	SEG13		LCD controller/driver segment output pin
9	P40	F	General-purpose I/O port
	SEG14		LCD controller/driver segment output pin
10	P41	F	General-purpose I/O port
	SEG15		LCD controller/driver segment output pin
11	P42	F	General-purpose I/O port
	SEG16		LCD controller/driver segment output pin
12	P43	F	General-purpose I/O port
	SEG17		LCD controller/driver segment output pin
18	P44	F	General-purpose I/O port
	SEG18		LCD controller/driver segment output pin
19	P45	F	General-purpose I/O port
	SEG19		LCD controller/driver segment output pin
20	P46	F	General-purpose I/O port
	SEG20		LCD controller/driver segment output pin
21	P47	F	General-purpose I/O port
	SEG21		LCD controller/driver segment output pin
37	P50	I	General-purpose I/O port
	INT0		INT0 external interrupt input pin
	ADTG		A/D converter external trigger input pin
58	P51	I	General-purpose I/O port
	INT1		INT1 external interrupt input pin
	RX1		CAN interface 1 RX input pin
	RX3		CAN interface 3 RX input pin
59	P52	I	General-purpose I/O port
	TX1		CAN interface 1 TX output pin
	TX3		CAN interface 3 TX output pin
60	P53	I	General-purpose I/O port
	INT3		INT3 external interrupt input pin

(Continued)



# MB90920 Series

Pin no.	Pin name	I/O circuit type*1	Function
61	P54	I	General-purpose I/O port
	TX0		CAN interface 0 TX output pin
	TX2		CAN interface 2 TX output pin
	SGA1		Sound generator ch.1 SGA output pin
63	P55	I	General-purpose I/O port
	RX0		CAN interface 0 RX input pin
	RX2		CAN interface 2 RX input pin
	INT2		INT2 external interrupt input pin
91	P56	I	General-purpose I/O port
	SGO0		Sound generator ch.0 SGO output pin
	FRCK		Free-run timer clock input pin
92	P57	I	General-purpose I/O port
	SGA0		Sound generator ch.0 SGA output pin
39	P60	H	General-purpose I/O port
	AN0		A/D converter input pin
40	P61	H	General-purpose I/O port
	AN1		A/D converter input pin
41	P62	H	General-purpose I/O port
	AN2		A/D converter input pin
42	P63	H	General-purpose I/O port
	AN3		A/D converter input pin
43	P64	H	General-purpose I/O port
	AN4		A/D converter input pin
44	P65	H	General-purpose I/O port
	AN5		A/D converter input pin
45	P66	H	General-purpose I/O port
	AN6		A/D converter input pin
46	P67	H	General-purpose I/O port
	AN7		A/D converter input pin
67	P70	L	General-purpose output-only port
	PWM1P0		Stepping motor controller ch.0 output pin
68	P71	L	General-purpose output-only port
	PWM1M0		Stepping motor controller ch.0 output pin
69	P72	L	General-purpose output-only port
	PWM2P0		Stepping motor controller ch.0 output pin

(Continued)

# MB90920 Series

Pin no.	Pin name	I/O circuit type*1	Function
70	P73	L	General-purpose output-only port
	PWM2M0		Stepping motor controller ch.0 output pin
71	P74	L	General-purpose output-only port
	PWM1P1		Stepping motor controller ch.1 output pin
72	P75	L	General-purpose output-only port
	PWM1M1		Stepping motor controller ch.1 output pin
73	P76	L	General-purpose output-only port
	PWM2P1		Stepping motor controller ch.1 output pin
74	P77	L	General-purpose output-only port
	PWM2M1		Stepping motor controller ch.1 output pin
77	P80	L	General-purpose output-only port
	PWM1P2		Stepping motor controller ch.2 output pin
78	P81	L	General-purpose output-only port
	PWM1M2		Stepping motor controller ch.2 output pin
79	P82	L	General-purpose output-only port
	PWM2P2		Stepping motor controller ch.2 output pin
80	P83	L	General-purpose output-only port
	PWM2M2		Stepping motor controller ch.2 output pin
81	P84	L	General-purpose output-only port
	PWM1P3		Stepping motor controller ch.3 output pin
82	P85	L	General-purpose output-only port
	PWM1M3		Stepping motor controller ch.3 output pin
83	P86	L	General-purpose output-only port
	PWM2P3		Stepping motor controller ch.3 output pin
84	P87	L	General-purpose output-only port
	PWM2M3		Stepping motor controller ch.3 output pin
22	P90	F	General-purpose I/O port
	SEG22		LCD controller/driver segment output pin
23	P91	F	General-purpose I/O port
	SEG23		LCD controller/driver segment output pin
31	P94	G	General-purpose I/O port
	V0		LCD controller/driver reference power supply pin
32	P95	G	General-purpose I/O port
	V1		LCD controller/driver reference power supply pin

(Continued)

# MB90920 Series

Pin no.	Pin name	I/O circuit type*1	Function
33	P96	G	General-purpose I/O port
	V2		LCD controller/driver reference power supply pin
34	V3	—	LCD controller/driver reference power supply pin
48	PC0	J	General-purpose I/O port
	SIN0		UART ch.0 serial data input pin
	INT4		INT4 external interrupt input pin
49	PC1	I	General-purpose I/O port
	SOT0		UART ch.0 serial data output pin
	INT5		INT5 external interrupt input pin
	IN3		Input capture ch.3 trigger input pin
50	PC2	I	General-purpose I/O port
	SCK0		UART ch.0 serial clock I/O pin
	INT6		INT6 external interrupt input pin
	IN2		Input capture ch.2 trigger input pin
51	PC3	J	General-purpose I/O port
	SIN1		UART ch.1 serial data input pin
	INT7		INT7 external interrupt input pin
52	PC4	I	General-purpose I/O port
	SOT1		UART ch.1 serial data output pin
53	PC5	I	General-purpose I/O port
	SCK1		UART ch.1 serial clock I/O pin
	TRG		16-bit PPG ch.0 to ch.5 external trigger input pin
54	PC6	I	General-purpose I/O port
	PPG0		16-bit PPG ch.0 output pin
	TOT1		16-bit reload timer ch.1 TOT output pin
	IN7		Input capture ch.7 trigger input pin
55	PC7	I	General-purpose I/O port
	PPG1		16-bit PPG ch.1 output pin
	TIN1		16-bit reload timer ch.1 TIN input pin
	IN6		Input capture ch.6 trigger input pin
24	PD0	J	General-purpose I/O port
	SIN2		UART ch.2 serial data input pin
25	PD1	I	General-purpose I/O port
	SOT2		UART ch.2 serial data output pin

(Continued)

(Continued)

Pin no.	Pin name	I/O circuit type*1	Function
26	PD2	I	General-purpose I/O port
	SCK2		UART ch.2 serial clock I/O pin
27	PD3	J	General-purpose I/O port
	SIN3		UART ch.3 serial data input pin
28	PD4	I	General-purpose I/O port
	SOT3		UART ch.3 serial data output pin
29	PD5	I	General-purpose I/O port
	SCK3		UART ch.3 serial clock I/O pin
30	PD6	I	General-purpose I/O port
	TOT2		16-bit reload timer ch.2 TOT output pin
56	PE0	I	General-purpose I/O port
	TOT3		16-bit reload timer ch.3 TOT output pin
57	PE1	I	General-purpose I/O port
	TIN3		16-bit reload timer ch.3 TIN input pin
64	PE2	I	General-purpose I/O port
	SGO1		Sound generator ch.1 SGO output pin
62	RSTO	N	Internal reset signal output pin
65, 75, 85	DVCC	—	Power supply input pins dedicated for high current output buffer
66, 76, 86	DVSS	—	Power supply GND pins dedicated for high current output buffer
35	AVCC	—	A/D converter dedicated power supply input pin
38	AVSS	—	A/D converter dedicated power supply GND pin
36	AVRH	—	A/D converter Vref+ input pin. Vref- is fixed to AVSS.
89	MD0	D	Mode setting input pin. Connect to VCC pin.
88	MD1	D	Mode setting input pin. Connect to VCC pin.
87	MD2	D/E*2	Mode setting input pin. Connect to VSS pin.
17	C	—	External capacitor pin. Connect a 0.1 μF capacitor between this pin and the VSS pin.
15, 105	VCC	—	Power supply input pins
16, 47, 106	VSS	—	GND power supply pins

\*1 : For I/O circuit type, refer to “■ I/O CIRCUIT TYPES”.

\*2 : The I/O circuit type is D for Flash memory products and E for evaluation products.

# MB90920 Series

## ■ I/O CIRCUIT TYPE

Type	Circuit	Remarks
A		Oscillation circuit High-speed oscillation feedback resistance : approx. 1 M $\Omega$ (Flash memory product/MASK ROM product/Evaluation product)
B		Oscillation circuit Low-speed oscillation feedback resistance : approx. 10 M $\Omega$
C		Input-only pin (with pull-up resistance) <ul style="list-style-type: none"> <li>Attached pull-up resistor : approx. 50 k<math>\Omega</math></li> <li>CMOS hysteresis input (<math>V_{IH}/V_{IL} = 0.8 V_{CC}/0.2 V_{CC}</math>)</li> </ul>
D		Input-only pin <ul style="list-style-type: none"> <li>CMOS hysteresis input (<math>V_{IH}/V_{IL} = 0.8 V_{CC}/0.2 V_{CC}</math>)</li> </ul> Note: The MD2 pin of the Flash memory products uses this circuit type.

(Continued)

Type	Circuit	Remarks
E	 <p style="text-align: center;">Pull-down resistor</p> <p style="text-align: right;">CMOS hysteresis input</p>	<p>Input-only pin (with pull-down resistance)</p> <ul style="list-style-type: none"> <li>Attached pull-down resistance: approx. 50 k<math>\Omega</math></li> <li>CMOS hysteresis input (<math>V_{IH}/V_{IL} = 0.8 V_{CC}/0.2 V_{CC}</math>)</li> </ul> <p>Note: The MD2 pin of the evaluation products uses this circuit type.</p>
F	 <p style="text-align: right;">Pout</p> <p style="text-align: right;">Nout</p> <p style="text-align: right;">LCD input</p> <p style="text-align: right;">CMOS hysteresis input Standby control signal or LCD input enable signal</p> <p style="text-align: right;">Automotive input Standby control signal or LCD input enable signal</p>	<p>LCD output common general-purpose port</p> <ul style="list-style-type: none"> <li>CMOS output (<math>I_{OH}/I_{OL} = \pm 4 \text{ mA}</math>)</li> <li>Hysteresis input (<math>V_{IH}/V_{IL} = 0.8 V_{CC}/0.2 V_{CC}</math>)</li> <li>Automotive input (<math>V_{IH}/V_{IL} = 0.8 V_{CC}/0.5 V_{CC}</math>)</li> </ul>
G	 <p style="text-align: right;">Pout</p> <p style="text-align: right;">Nout</p> <p style="text-align: right;">LCD reference power supply input</p> <p style="text-align: right;">CMOS hysteresis input Standby control signal or LCD output switching signal</p> <p style="text-align: right;">Automotive input Standby control signal or LCD output switching signal</p>	<p>LCDC reference power supply common general-purpose port</p> <ul style="list-style-type: none"> <li>CMOS output (<math>I_{OH}/I_{OL} = \pm 4 \text{ mA}</math>)</li> <li>CMOS hysteresis input (<math>V_{IH}/V_{IL} = 0.8 V_{CC}/0.2 V_{CC}</math>)</li> <li>Automotive input (<math>V_{IH}/V_{IL} = 0.8 V_{CC}/0.5 V_{CC}</math>)</li> </ul>

(Continued)

# MB90920 Series

Type	Circuit	Remarks
H		<p>A/D converter input common general-purpose port</p> <ul style="list-style-type: none"> <li>• CMOS output (<math>I_{OH}/I_{OL} = \pm 4 \text{ mA}</math>)</li> <li>• CMOS hysteresis input (<math>V_{IH}/V_{IL} = 0.8 V_{CC}/0.2 V_{CC}</math>)</li> <li>• Automotive input (<math>V_{IH}/V_{IL} = 0.8 V_{CC}/0.5 V_{CC}</math>)</li> </ul>
I		<p>General-purpose port</p> <ul style="list-style-type: none"> <li>• CMOS output (<math>I_{OH}/I_{OL} = \pm 4 \text{ mA}</math>)</li> <li>• CMOS hysteresis input (<math>V_{IH}/V_{IL} = 0.8 V_{CC}/0.2 V_{CC}</math>)</li> <li>• Automotive input (<math>V_{IH}/V_{IL} = 0.8 V_{CC}/0.5 V_{CC}</math>)</li> </ul>
J		<p>General-purpose port (serial input)</p> <ul style="list-style-type: none"> <li>• CMOS output (<math>I_{OH}/I_{OL} = \pm 4 \text{ mA}</math>)</li> <li>• CMOS hysteresis input (<math>V_{IH}/V_{IL} = 0.8 V_{CC}/0.2 V_{CC}</math>)</li> <li>• CMOS input (SIN) (<math>V_{IH}/V_{IL} = 0.7 V_{CC}/0.3 V_{CC}</math>)</li> <li>• Automotive input (<math>V_{IH}/V_{IL} = 0.8 V_{CC}/0.5 V_{CC}</math>)</li> </ul>

(Continued)

Type	Circuit	Remarks
K	 <p>             P-ch MOSFET (Pout)              N-ch MOSFET (Nout)              Analog output              CMOS hysteresis input              Standby control signal or analog input enable signal              Automotive input              Standby control signal or analog input enable signal              CMOS input (SIN)              Standby control signal or analog input enable signal         </p>	<p>A/D converter input common general-purpose port (serial input)</p> <ul style="list-style-type: none"> <li>• CMOS output (<math>I_{OH}/I_{OL} = \pm 4 \text{ mA}</math>)</li> <li>• CMOS hysteresis input (<math>V_{IH}/V_{IL} = 0.8 V_{CC}/0.2 V_{CC}</math>)</li> <li>• CMOS input (SIN) (<math>V_{IH}/V_{IL} = 0.7 V_{CC}/0.3 V_{CC}</math>)</li> <li>• Automotive input (<math>V_{IH}/V_{IL} = 0.8 V_{CC}/0.5 V_{CC}</math>)</li> </ul>
L	 <p>             P-ch MOSFET (Pout)              High current              N-ch MOSFET (Nout)         </p>	<p>High current output port (SMC pin)              CMOS output (<math>I_{OH}/I_{OL} = \pm 30 \text{ mA}</math>)</p>
M	 <p>             P-ch MOSFET (Pout)              N-ch MOSFET (Nout)              LCDC output              CMOS hysteresis input              Standby control signal or LCDC output switching signal              Automotive input              Standby control signal or LCDC output switching signal              CMOS input (SIN)              Standby control signal or LCDC output switching signal         </p>	<p>LCDC output common general-purpose port (serial input)</p> <ul style="list-style-type: none"> <li>• CMOS output (<math>I_{OH}/I_{OL} = \pm 4 \text{ mA}</math>)</li> <li>• CMOS hysteresis input (<math>V_{IH}/V_{IL} = 0.8 V_{CC}/0.2 V_{CC}</math>)</li> <li>• CMOS input (SIN) (<math>V_{IH}/V_{IL} = 0.7 V_{CC}/0.3 V_{CC}</math>)</li> <li>• Automotive input (<math>V_{IH}/V_{IL} = 0.8 V_{CC}/0.5 V_{CC}</math>)</li> </ul>

(Continued)



# MB90920 Series

(Continued)

Type	Circuit	Remarks
N	<div style="display: flex; justify-content: space-around;"> <div style="text-align: center;"> <p>Evaluation product</p>  </div> <div style="text-align: center;"> <p>Flash memory product</p>  </div> </div>	<p>N-ch open-drain pin  <math>I_{OL} = 4 \text{ mA}</math></p>
O		<p>Input-only pin          Automotive input  <math>(V_{IH}/V_{IL} = 0.8 V_{CC}/0.5 V_{CC})</math></p>
P		<p>LCDC output pin (COM pin)</p>

## ■ HANDLING DEVICES

- **Strictly observe maximum rated voltages (preventing latch-up)**

In CMOS IC devices, a condition known as latch-up may occur if voltages higher than  $V_{CC}$  or lower than  $V_{SS}$  are applied to input or output pins other than medium or high withstand voltage pins, or if the voltage applied between  $V_{CC}$  and  $V_{SS}$  pins exceeds the rated voltage level. If a latch-up occurs, the power supply current may increase dramatically and may destroy semiconductor elements. When using semiconductor devices, always take sufficient care to avoid exceeding maximum ratings.

When the analog system power supply is switched on or off, be careful not to apply the analog power supply ( $AV_{CC}$ ,  $AV_{RH}$ ), the analog input voltages and the power supply voltage for the high current output buffer pins ( $DV_{CC}$ ) in excess of the digital power supply voltage ( $V_{CC}$ ).

Once the digital power supply voltage ( $V_{CC}$ ) has been disconnected, the analog power supply ( $AV_{CC}$ ,  $AV_{RH}$ ) and the power supply voltage for the high current output buffer pins ( $DV_{CC}$ ) may be turned on in any sequence.

- **Supply voltage stabilization**

Rapid fluctuations in the power supply voltage can cause malfunctions even if the  $V_{CC}$  power supply voltage remains within the warranted operating range. It is recommended that the power supply be stabilized such that ripple fluctuations (P-P value) at commercial frequencies (50 Hz/60 Hz) be limited to within 10% of the standard  $V_{CC}$  value, and that transient fluctuations due to power supply switching, etc. be limited to a rate of 0.1 V/ms or less.

- **Precautions when turning the power on**

In order to prevent the built-in step-down circuits from malfunctioning, the time taken for the voltage to rise (0.2 V to 2.7 V) during power-on should be less than 50  $\mu$ s.

- **Handling unused pins**

If unused input pins are left open, they may cause malfunctions or latch-up which may lead to permanent damage to the semiconductor. Unused input pins should therefore be pulled up or pulled down through a resistor of at least 2 k $\Omega$ .

Unused input/output pins may be set to the output state and left open, or set to the input state and connected to a pull-up or pull-down resistance of 2 k $\Omega$  or more.

- **Handling A/D converter power supply pins**

Even if the A/D converter is not used, the power supply pins should be connected such as  $AV_{CC} = V_{CC}$ , and  $AV_{SS} = AVR_{H} = V_{SS}$ .

- **Notes on using an external clock**

Even when an external clock is used, an oscillation stabilization wait time is required following power-on reset or release from sub clock mode or stop mode. Furthermore, only the X0A pin should be driven when an external clock is used, with the X1A pin open as shown in the following diagram. Do not use high-speed oscillation pins (X0 and X1) for external clock input.

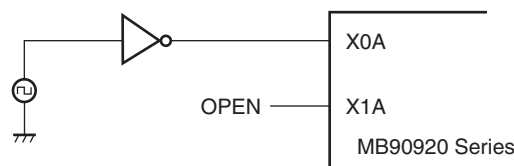

Sample external clock connection

## • Notes on operating in PLL clock mode

On this microcontroller, if in case the crystal oscillator breaks off or an external reference clock input stops while the PLL clock mode is selected, a self-oscillator circuit contained in the PLL may continue its operation at its self-running frequency. However, FUJITSU SEMICONDUCTOR will not guarantee results of operations if such failure occurs.

## • Crystal oscillator circuit

Noise around the X0/X1, or X0A/X1A pins may cause this device to operate abnormally. In the interest of stable operation it is strongly recommended that printed circuit artwork places ground bypass capacitors as close as possible to the X0/X1, X0A/X1A and crystal oscillator (or ceramic oscillator) and that oscillator lines do not cross the lines of other circuits.

Please ask each crystal maker to evaluate the oscillational characteristics of the crystal and this device.

## • Power supply pins

Devices including multiple VCC or VSS pins are designed such that pins that need to be at the same potential are interconnected internally to prevent malfunctions such as latch-up. To reduce unnecessary radiation, prevent malfunctioning of the strobe signal due to the rise of ground level, and observe the standard for total output current, be sure to connect the VCC and VSS pins to the power supply and ground externally.

Always connect all of the VCC pins to the same potential and all of the VSS pins to ground as shown in the following diagram. The device will not operate correctly if multiple VCC or VSS pins are connected to different voltages, even if those voltages are within the guaranteed operating ranges.



In addition, care must be given to connecting the VCC and VSS pins of this device to the current supply source with as low impedance as possible. It is recommended that a 1.0  $\mu\text{F}$  bypass capacitor be connected between the VCC and VSS pins as close to the pins as possible.

## • Sequence for connecting the A/D converter power supply and analog inputs

The A/D converter power supply ( $AV_{CC}$ ,  $AVRH$ ) and analog inputs ( $AN0$  to  $AN7$ ) must be applied after the digital power supply ( $V_{CC}$ ) is switched on. When turning the power off, the A/D converter power supply and analog inputs must be disconnected before the digital power supply is switched off ( $V_{CC}$ ). Ensure that  $AVRH$  does not exceed  $AV_{CC}$  during either power-on or power-off. Even when pins which double as analog input pins are used as input ports, be sure that the input voltage does not exceed  $AV_{CC}$  (turning on/off the analog and digital power supplies simultaneously is acceptable).

- **Handling the power supply for high-current output buffer pins ( $DV_{CC}$ ,  $DV_{SS}$ )**

- **Flash memory products and MASK ROM products (MB90F922NC/F922NCS/922NCS/F923NC/F923NCS/F924NC/F924NCS)**

In the Flash memory products and MASK ROM products, the power supply for the high-current output buffer pins ( $DV_{CC}$ ,  $DV_{SS}$ ) is isolated from the digital power supply ( $V_{CC}$ ).

Therefore,  $DV_{CC}$  can therefore be set to a higher voltage than  $V_{CC}$ . If the power supply for the high-current output buffer pins ( $DV_{CC}$ ,  $DV_{SS}$ ) is supplied before the digital power supply ( $V_{CC}$ ), however, care needs to be taken because it is possible that the port 7 or port 8 stepping motor outputs may momentarily output an “H” or “L” level. In order to prevent this, connect the digital power supply ( $V_{CC}$ ) prior to connecting the power supply for the high-current output buffer pins. Even when the high-current output buffer pins are used as general-purpose ports, power should be supplied to the power supply pins for the high-current output buffer pins ( $DV_{CC}$ ,  $DV_{SS}$ ).

- **Evaluation product (MB90V920-101/MB90V920-102)**

In the evaluation products, the power supply for the high-current output buffer pins ( $DV_{CC}$ ,  $DV_{SS}$ ) is not isolated from the digital power supply ( $V_{CC}$ ). Therefore,  $DV_{CC}$  must therefore be set to a lower voltage than  $V_{CC}$ . The power supply for the high-current output buffer pins ( $DV_{CC}$ ,  $DV_{SS}$ ) must always be applied after the digital power supply ( $V_{CC}$ ) has been connected, and disconnected before the digital power supply ( $V_{CC}$ ) is disconnected (the power supply for the high-current output buffer pins may also be connected and disconnected simultaneously with the digital power supply).

Even when the high-current output buffer pins are used as general-purpose ports, power should be supplied to the power supply pins for the high-current output buffer pins ( $DV_{CC}$ ,  $DV_{SS}$ ).

- **Pull-up/pull-down resistors**

MB90920 series does not support internal pull-up/pull-down resistors. Use external components as necessary.

- **Precautions when not using a sub clock signal**

If the X0A and X1A pins are not connected to an oscillator, apply a pull-down resistance to the X0A pin and leave the X1A pin open.

- **Notes on operating when the external clock is stopped**

The MB90920 series is not guaranteed to operate correctly using the internal oscillator circuit when there is no external oscillator or the external clock input is stopped.

- **Flash memory security function**

A security bit is located within the Flash memory region. The security function is activated by writing the protection code 01<sub>H</sub> to the security bit.

Do not write the value 01<sub>H</sub> to this address if you are not using the security function.

Please refer to following table for the address of the security bit.

	Flash memory size	Address for security bit
MB90F922NC MB90F922NCS	Built-in 2 Mbits Flash Memory	FC0001 <sub>H</sub>
MB90F923NCS	Built-in 3 Mbits Flash Memory	F80001 <sub>H</sub>
MB90F924NCS	Built-in 4 Mbits Flash Memory	F80001 <sub>H</sub>

- **Serial communication**

In serial communication, reception of wrong data may occur due to noise or other causes. Therefore, design a printed circuit board to prevent noise from occurring. Taking account of the reception of wrong data, detect errors by measures such as adding a checksum to the end of data. If an error is detected, retransmit the data.

- **Characteristic difference between flash device and MASK ROM device**

In the flash device and the MASK ROM device, the electrical characteristic including current consumption, ESD, latch-up, the noise characteristic, and oscillation characteristic, etc. is different according to the difference between the chip layout and the memory structure.

Reconfirm the electrical characteristic when the product is replaced by another product of the same series.

## ■ BLOCK DIAGRAM



# MB90920 Series

## MEMORY MAP



Parts No.	ROM (Flash) capacitance	RAM capacitance	Address #1	Address #2	Address #3
MB90F922NC/F922NCS/922NCS	256 Kbytes	10 Kbytes	FC000H	00400H	002900H
MB90F923NC/F923NCS	384 Kbytes	16 Kbytes	FA000H	004A0H	003700H
MB90F924NC/F924NCS	512 Kbytes	24 Kbytes	F8000H	006A0H	003700H

\* : Evaluation products do not contain internal ROM. Treat this address as the ROM decode area used by the tools.

Note: To select models without the ROM mirror function, refer to the “ROM Mirror Function Selection Module” in Hardware Manual. The image of the ROM data in the FF bank appears at the top of the 00 bank, in order to enable efficient use of small C compiler models. The lower 16-bits of the FF bank addresses are allocated to the same addresses as the lower 16-bits of the 00 bank, making it possible to reference tables in ROM without declaring the “far” modifier with the pointers. For example, when an access is made to the address 00C00H, the actual address to be accessed is FFC00H in ROM. Because the size of the FF bank ROM area exceeds 32 Kbytes, it is not possible to view the entire region in the 00 bank image. Therefore because the ROM data from FF800H to FFFFFFFH appears in the image from 00800H to 00FFFFH, it is recommended that ROM data tables be stored in the area from FF800H to FFFFFFFH.

## ■ I/O MAP

Address	Register name	Symbol	Read/write	Resource name	Initial value
00000H	Port 0 data register	PDR0	R/W	Port 0	XXXXXXXX <sub>B</sub>
00001H	Port 1 data register	PDR1	R/W	Port 1	XXXXXXXX <sub>B</sub>
00002H	Port 2 data register	PDR2	R/W	Port 2	XXXXXXXX <sub>B</sub>
00003H	Port 3 data register	PDR3	R/W	Port 3	XXXXXXXX <sub>B</sub>
00004H	Port 4 data register	PDR4	R/W	Port 4	XXXXXXXX <sub>B</sub>
00005H	Port 5 data register	PDR5	R/W	Port 5	XXXXXXXX <sub>B</sub>
00006H	Port 6 data register	PDR6	R/W	Port 6	XXXXXXXX <sub>B</sub>
00007H	Port 7 data register	PDR7	R/W	Port 7	XXXXXXXX <sub>B</sub>
00008H	Port 8 data register	PDR8	R/W	Port 8	XXXXXXXX <sub>B</sub>
00009H	Port 9 data register	PDR9	R/W	Port 9	XXXXXXXX <sub>B</sub>
0000AH, 0000BH	(Disabled)				
0000CH	Port C data register	PDRC	R/W	Port C	XXXXXXXX <sub>B</sub>
0000DH	Port D data register	PDRD	R/W	Port D	XXXXXXXX <sub>B</sub>
0000EH	Port E data register	PDRE	R/W	Port E	XXXXXXXX <sub>B</sub>
0000FH	(Disabled)				
00010H	Port 0 direction register	DDR0	R/W	Port 0	00000000 <sub>B</sub>
00011H	Port 1 direction register	DDR1	R/W	Port 1	XX000000 <sub>B</sub>
00012H	Port 2 direction register	DDR2	R/W	Port 2	000000XX <sub>B</sub>
00013H	Port 3 direction register	DDR3	R/W	Port 3	00000000 <sub>B</sub>
00014H	Port 4 direction register	DDR4	R/W	Port 4	00000000 <sub>B</sub>
00015H	Port 5 direction register	DDR5	R/W	Port 5	00000000 <sub>B</sub>
00016H	Port 6 direction register	DDR6	R/W	Port 6	00000000 <sub>B</sub>
00017H	Port 7 direction register	DDR7	R/W	Port 7	00000000 <sub>B</sub>
00018H	Port 8 direction register	DDR8	R/W	Port 8	00000000 <sub>B</sub>
00019H	Port 9 direction register	DDR9	R/W	Port 9	X0000000 <sub>B</sub>
0001AH	Analog input enable	ADER6	R/W	Port 6, A/D	11111111 <sub>B</sub>
0001BH	(Disabled)				
0001CH	Port C direction register	DDRC	R/W	Port C	00000000 <sub>B</sub>
0001DH	Port D direction register	DDRD	R/W	Port D	X0000000 <sub>B</sub>
0001EH	Port E direction register	DDRE	R/W	Port E	XXXXX000 <sub>B</sub>
0001FH	(Disabled)				
00020H	Lower A/D control status register	ADCS0	R/W	A/D converter	00XXXX00 <sub>B</sub>
00021H	Higher A/D control status register	ADCS1	R/W		0000000X <sub>B</sub>
00022H	Lower A/D control status register	ADCR0	R		00000000 <sub>B</sub>
00023H	Higher A/D data register	ADCR1	R		XXXXXX00 <sub>B</sub>

(Continued)



# MB90920 Series

Address	Register name	Symbol	Read/write	Resource name	Initial value
000024 <sub>H</sub>	Compare clear register	CPCLR	R/W	16-bit free-run timer	XXXXXXXX <sub>B</sub>
000025 <sub>H</sub>			R/W		XXXXXXXX <sub>B</sub>
000026 <sub>H</sub>	Timer data register	TCDT	R/W		00000000 <sub>B</sub>
000027 <sub>H</sub>			R/W		00000000 <sub>B</sub>
000028 <sub>H</sub>	Lower timer control status register	TCCSL	R/W		00000000 <sub>B</sub>
000029 <sub>H</sub>	Higher timer control status register	TCCSH	R/W		01-00000 <sub>B</sub>
00002A <sub>H</sub>	Lower PPG0 control status register	PCNTL0	R/W	16-bit PPG0	00000000 <sub>B</sub>
00002B <sub>H</sub>	Higher PPG0 control status register	PCNTH0	R/W		00000001 <sub>B</sub>
00002C <sub>H</sub>	Lower PPG1 control status register	PCNTL1	R/W	16-bit PPG1	00000000 <sub>B</sub>
00002D <sub>H</sub>	Higher PPG1 control status register	PCNTH1	R/W		00000001 <sub>B</sub>
00002E <sub>H</sub>	Lower PPG2 control status register	PCNTL2	R/W	16-bit PPG2	00000000 <sub>B</sub>
00002F <sub>H</sub>	Higher PPG2 control status register	PCNTH2	R/W		00000001 <sub>B</sub>
000030 <sub>H</sub>	External interrupt enable	ENIR	R/W	External interrupt	00000000 <sub>B</sub>
000031 <sub>H</sub>	External interrupt request	EIRR	R/W		00000000 <sub>B</sub>
000032 <sub>H</sub>	Lower external interrupt level	ELVRL	R/W		00000000 <sub>B</sub>
000033 <sub>H</sub>	Higher external interrupt level	ELVRH	R/W		00000000 <sub>B</sub>
000034 <sub>H</sub>	Serial mode register 0	SMR0	R/W, W	UART (LIN/SCI) 0	00000000 <sub>B</sub>
000035 <sub>H</sub>	Serial control register 0	SCR0	R/W, W		00000000 <sub>B</sub>
000036 <sub>H</sub>	Reception/transmission data register 1	RDR0/ TDR0	R/W		00000000 <sub>B</sub>
000037 <sub>H</sub>	Serial status register 0	SSR0	R/W, R		00001000 <sub>B</sub>
000038 <sub>H</sub>	Extended communication control register 0	ECCR0	R/W, R		000000XX <sub>B</sub>
000039 <sub>H</sub>	Extended status control register 0	ESCR0	R/W		00000100 <sub>B</sub>
00003A <sub>H</sub>	Baud rate generator register 00	BGR00	R/W		00000000 <sub>B</sub>
00003B <sub>H</sub>	Baud rate generator register 01	BGR01	R/W, R		00000000 <sub>B</sub>
00003C <sub>H</sub> to 00003F <sub>H</sub>	(Disabled)				
000040 <sub>H</sub> to 00004F <sub>H</sub>	Area reserved for CAN Controller 0. Refer to "■ CAN CONTROLLERS"				
000050 <sub>H</sub>	Lower timer control status register 0	TMCSR0L	R/W	16-bit reload timer 0	00000000 <sub>B</sub>
000051 <sub>H</sub>	Higher timer control status register 0	TMCSR0H	R/W		XXX10000 <sub>B</sub>
000052 <sub>H</sub>	Timer register 0/reload register 0	TMR0/ TMRLR0	R/W		XXXXXXXX <sub>B</sub>
000053 <sub>H</sub>					XXXXXXXX <sub>B</sub>

(Continued)

# MB90920 Series

Address	Register name	Symbol	Read/write	Resource name	Initial value
000054 <sub>H</sub>	Lower timer control status register 1	TMCSR1L	R/W	16-bit reload timer 1	00000000 <sub>B</sub>
000055 <sub>H</sub>	Higher timer control status register 1	TMCSR1H	R/W		XXX10000 <sub>B</sub>
000056 <sub>H</sub>	Timer register 1/reload register 1	TMR1/ TMRLR1	R/W		XXXXXXXX <sub>B</sub>
000057 <sub>H</sub>		XXXXXXXX <sub>B</sub>			
000058 <sub>H</sub>	LCD output control register 1	LOCR1	R/W	LCDC	11111111 <sub>B</sub>
000059 <sub>H</sub>	LCD output control register 2	LOCR2	R/W		00000000 <sub>B</sub>
00005A <sub>H</sub>	Lower sound control register 0	SGCRL0	R/W	Sound generator 0	00000000 <sub>B</sub>
00005B <sub>H</sub>	Higher sound control register 0	SGCRH0	R/W		0XXXX100 <sub>B</sub>
00005C <sub>H</sub>	Frequency data register 0	SGFR0	R/W		XXXXXXXX <sub>B</sub>
00005D <sub>H</sub>	Amplitude data register 0	SGAR0	R/W		00000000 <sub>B</sub>
00005E <sub>H</sub>	Decrement grade register 0	SGDR0	R/W		XXXXXXXX <sub>B</sub>
00005F <sub>H</sub>	Tone count register 0	SGTR0	R/W		XXXXXXXX <sub>B</sub>
000060 <sub>H</sub>	Input capture register 0	IPCP0	R	Input capture 0/1	XXXXXXXX <sub>B</sub>
000061 <sub>H</sub>					XXXXXXXX <sub>B</sub>
000062 <sub>H</sub>	Input capture register 1	IPCP1	R		XXXXXXXX <sub>B</sub>
000063 <sub>H</sub>					XXXXXXXX <sub>B</sub>
000064 <sub>H</sub>	Input capture register 2	IPCP2	R	Input capture 2/3	XXXXXXXX <sub>B</sub>
000065 <sub>H</sub>					XXXXXXXX <sub>B</sub>
000066 <sub>H</sub>	Input capture register 3	IPCP3	R		XXXXXXXX <sub>B</sub>
000067 <sub>H</sub>					XXXXXXXX <sub>B</sub>
000068 <sub>H</sub>	Input capture control status 0/1	ICS01	R/W	Input capture 0/1	00000000 <sub>B</sub>
000069 <sub>H</sub>	Input capture edge register 0/1	ICE01	R/W		XXX0X0XX <sub>B</sub>
00006A <sub>H</sub>	Input capture control status 2/3	ICS23	R/W	Input capture 2/3	00000000 <sub>B</sub>
00006B <sub>H</sub>	Input capture edge register 2/3	ICE23	R/W		XXXXXXXX <sub>B</sub>
00006C <sub>H</sub>	Lower LCD control register	LCRL	R/W	LCD controller/ driver	00010000 <sub>B</sub>
00006D <sub>H</sub>	Higher LCD control register	LCRH	R/W		00000000 <sub>B</sub>
00006E <sub>H</sub>	Low voltage/CPU operation detection reset control register	LVRC	R/W	Low voltage/CPU operation detection reset	00111000 <sub>B</sub>
00006F <sub>H</sub>	ROM mirror	ROMM	W	ROM mirror	XXXXXXXX1 <sub>B</sub>
000070 <sub>H</sub> to 00007F <sub>H</sub>	Area reserved for CAN Controller 1. Refer to "■ CAN CONTROLLERS"				
000080 <sub>H</sub>	PWM control register 0	PWC0	R/W	Stepping motor controller 0	000000X0 <sub>B</sub>
000081 <sub>H</sub>	(Disabled)				
000082 <sub>H</sub>	PWM control register 1	PWC1	R/W	Stepping motor controller 1	000000X0 <sub>B</sub>

(Continued)

# MB90920 Series

Address	Register name	Symbol	Read/write	Resource name	Initial value
000083 <sub>H</sub>	(Disabled)				
000084 <sub>H</sub>	PWM control register 2	PWC2	R/W	Stepping motor controller 2	000000X0 <sub>B</sub>
000085 <sub>H</sub>	(Disabled)				
000086 <sub>H</sub>	PWM control register 3	PWC3	R/W	Stepping motor controller 3	000000X0 <sub>B</sub>
000087 <sub>H</sub>	(Disabled)				
000088 <sub>H</sub>	LCD output control register 3	LOCR3	R/W	LCDC	XXXXX111 <sub>B</sub>
000089 <sub>H</sub>	(Disabled)				
00008A <sub>H</sub>	A/D setting register 0	ADSR0	R/W	A/D converter	00000000 <sub>B</sub>
00008B <sub>H</sub>	A/D setting register 1	ADSR1	R/W		00000000 <sub>B</sub>
00008C <sub>H</sub>	Port input level select 0	PIL0	R/W	Port input level select	00000000 <sub>B</sub>
00008D <sub>H</sub>	Port input level select 1	PIL1	R/W		XXXX0000 <sub>B</sub>
00008E <sub>H</sub>	Port input level select 2	PIL2	R/W		XXXX0000 <sub>B</sub>
00008F <sub>H</sub> to 00009D <sub>H</sub>	(Disabled)				
00009E <sub>H</sub>	Program address detection control register	PACSR	R/W	Address match detection	XXXX0X0X <sub>B</sub>
00009F <sub>H</sub>	Delayed Interrupt/Release Register	DIRR	R/W	Delay interrupt	XXXXXXXX0 <sub>B</sub>
0000A0 <sub>H</sub>	Power saving mode control register	LPMCR	R/W	Power saving control circuit	00011000 <sub>B</sub>
0000A1 <sub>H</sub>	Clock select register	CKSCR	R/W, R		11111100 <sub>B</sub>
0000A2 <sub>H</sub> to 0000A7 <sub>H</sub>	(Disabled)				
0000A8 <sub>H</sub>	Watchdog timer control register	WDTC	R, W	Watchdog timer	XXXXX111 <sub>B</sub>
0000A9 <sub>H</sub>	Time-base timer control register	TBTC	R/W, W	Time-base timer	1XX00100 <sub>B</sub>
0000AA <sub>H</sub>	Watch timer control register	WTC	R/W, W, R	Watch timer (sub clock)	10001000 <sub>B</sub>
0000AB <sub>H</sub> to 0000AD <sub>H</sub>	(Disabled)				
0000AE <sub>H</sub>	Flash memory control status register	FMCS	R/W	Flash interface	000X0000 <sub>B</sub>
0000AF <sub>H</sub>	(Disabled)				

(Continued)

# MB90920 Series

Address	Register name	Symbol	Read/write	Resource name	Initial value
0000B0 <sub>H</sub>	Interrupt control register 00	ICR00	R/W	Interrupt controller	00000111 <sub>B</sub>
0000B1 <sub>H</sub>	Interrupt control register 01	ICR01	R/W		00000111 <sub>B</sub>
0000B2 <sub>H</sub>	Interrupt control register 02	ICR02	R/W		00000111 <sub>B</sub>
0000B3 <sub>H</sub>	Interrupt control register 03	ICR03	R/W		00000111 <sub>B</sub>
0000B4 <sub>H</sub>	Interrupt control register 04	ICR04	R/W		00000111 <sub>B</sub>
0000B5 <sub>H</sub>	Interrupt control register 05	ICR05	R/W		00000111 <sub>B</sub>
0000B6 <sub>H</sub>	Interrupt control register 06	ICR06	R/W		00000111 <sub>B</sub>
0000B7 <sub>H</sub>	Interrupt control register 07	ICR07	R/W		00000111 <sub>B</sub>
0000B8 <sub>H</sub>	Interrupt control register 08	ICR08	R/W		00000111 <sub>B</sub>
0000B9 <sub>H</sub>	Interrupt control register 09	ICR09	R/W		00000111 <sub>B</sub>
0000BA <sub>H</sub>	Interrupt control register 10	ICR10	R/W		00000111 <sub>B</sub>
0000BB <sub>H</sub>	Interrupt control register 11	ICR11	R/W		00000111 <sub>B</sub>
0000BC <sub>H</sub>	Interrupt control register 12	ICR12	R/W		00000111 <sub>B</sub>
0000BD <sub>H</sub>	Interrupt control register 13	ICR13	R/W		00000111 <sub>B</sub>
0000BE <sub>H</sub>	Interrupt control register 14	ICR14	R/W		00000111 <sub>B</sub>
0000BF <sub>H</sub>	Interrupt control register 15	ICR15	R/W		00000111 <sub>B</sub>
0000C0 <sub>H</sub> to 0000C3 <sub>H</sub>	(Disabled)				
0000C4 <sub>H</sub>	Serial mode register 1	SMR1	R/W, W	UART (LIN/SCI) 1	00000000 <sub>B</sub>
0000C5 <sub>H</sub>	Serial control register 1	SCR1	R/W, W		00000000 <sub>B</sub>
0000C6 <sub>H</sub>	Reception/transmission data register 1	RDR1/ TDR1	R/W		00000000 <sub>B</sub>
0000C7 <sub>H</sub>	Serial status register 1	SSR1	R/W, R		00001000 <sub>B</sub>
0000C8 <sub>H</sub>	Extended communication control register 1	ECCR1	R/W, R		000000XX <sub>B</sub>
0000C9 <sub>H</sub>	Extended status control register 1	ESCR1	R/W		00000100 <sub>B</sub>
0000CA <sub>H</sub>	Baud rate generator register 10	BGR10	R/W		00000000 <sub>B</sub>
0000CB <sub>H</sub>	Baud rate generator register 11	BGR11	R/W, R		00000000 <sub>B</sub>
0000CC <sub>H</sub>	Lower watch timer control register	WTCRL	R/W	Real-time watch timer	000XXXX0 <sub>B</sub>
0000CD <sub>H</sub>	Middle watch timer control register	WTCRM	R/W		00000000 <sub>B</sub>
0000CE <sub>H</sub>	Higher watch timer control register	WTCRH	R/W		XXXXXX00 <sub>B</sub>
0000CF <sub>H</sub>	Sub clock control register	PSCCR	W	Sub clock	XXXX0000 <sub>B</sub>
0000D0 <sub>H</sub>	Input capture control status 4/5	ICS45	R/W	Input capture 4/5	00000000 <sub>B</sub>
0000D1 <sub>H</sub>	Input capture edge register 4/5	ICE45	R/W, R		XXXXXXXX <sub>B</sub>
0000D2 <sub>H</sub>	Input capture control status 6/7	ICS67	R/W	Input capture 6/7	00000000 <sub>B</sub>
0000D3 <sub>H</sub>	Input capture edge register 6/7	ICE67	R/W, R		XXX0X0XX <sub>B</sub>

(Continued)

# MB90920 Series

Address	Register name	Symbol	Read/write	Resource name	Initial value
0000D4 <sub>H</sub>	Lower timer control status register 2	TMCSR2L	R/W	16-bit reload timer 2	00000000 <sub>B</sub>
0000D5 <sub>H</sub>	Higher timer control status register 2	TMCSR2H	R/W		XXX10000 <sub>B</sub>
0000D6 <sub>H</sub>	Lower timer control status register 3	TMCSR3L	R/W	16-bit reload timer 3	00000000 <sub>B</sub>
0000D7 <sub>H</sub>	Higher timer control status register 3	TMCSR3H	R/W		XXX10000 <sub>B</sub>
0000D8 <sub>H</sub>	Lower sound control register 1	SGCRL1	R/W	Sound generator 1	00000000 <sub>B</sub>
0000D9 <sub>H</sub>	Higher sound control register 1	SGCRH1	R/W		0XXXX100 <sub>B</sub>
0000DA <sub>H</sub>	Lower PPG3 control status register	PCNTL3	R/W	16-bit PPG3	00000000 <sub>B</sub>
0000DB <sub>H</sub>	Higher PPG3 control status register	PCNTH3	R/W		00000001 <sub>B</sub>
0000DC <sub>H</sub>	Lower PPG4 control status register	PCNTL4	R/W	16-bit PPG4	00000000 <sub>B</sub>
0000DD <sub>H</sub>	Higher PPG4 control status register	PCNTH4	R/W		00000001 <sub>B</sub>
0000DE <sub>H</sub>	Lower PPG5 control status register	PCNTL5	R/W	16-bit PPG5	00000000 <sub>B</sub>
0000DF <sub>H</sub>	Higher PPG5 control status register	PCNTH5	R/W		00000001 <sub>B</sub>
0000E0 <sub>H</sub>	Serial mode register 2	SMR2	R/W, W	UART (LIN/SCI) 2	00000000 <sub>B</sub>
0000E1 <sub>H</sub>	Serial control register 2	SCR2	R/W, W		00000000 <sub>B</sub>
0000E2 <sub>H</sub>	Reception/transmission data register 2	RDR2/ TDR2	R/W		00000000 <sub>B</sub>
0000E3 <sub>H</sub>	Serial status register 2	SSR2	R/W, R		00001000 <sub>B</sub>
0000E4 <sub>H</sub>	Extended communication control register 2	ECCR2	R/W, R		000000XX <sub>B</sub>
0000E5 <sub>H</sub>	Extended status control register 2	ESCR2	R/W		00000100 <sub>B</sub>
0000E6 <sub>H</sub>	Baud rate generator register 20	BGR20	R/W		00000000 <sub>B</sub>
0000E7 <sub>H</sub>	Baud rate generator register 21	BGR21	R/W, R		00000000 <sub>B</sub>
0000E8 <sub>H</sub>	Serial mode register 3	SMR3	R/W, W		00000000 <sub>B</sub>
0000E9 <sub>H</sub>	Serial control register 3	SCR3	R/W, W		00000000 <sub>B</sub>
0000EA <sub>H</sub>	Reception/transmission data register 3	RDR3/ TDR3	R/W	00000000 <sub>B</sub>	
0000EB <sub>H</sub>	Serial status register 3	SSR3	R/W, R	00001000 <sub>B</sub>	
0000EC <sub>H</sub>	Extended communication control register 3	ECCR3	R/W, R	000000XX <sub>B</sub>	
0000ED <sub>H</sub>	Extended status control register 3	ESCR3	R/W	00000100 <sub>B</sub>	
0000EE <sub>H</sub>	Baud rate generator register 30	BGR30	R/W	00000000 <sub>B</sub>	
0000EF <sub>H</sub>	Baud rate generator register 31	BGR31	R/W, R	00000000 <sub>B</sub>	
001FF0 <sub>H</sub>	Program address detection register 0	PADR0	R/W	Address match detection	XXXXXXXX <sub>B</sub>
001FF1 <sub>H</sub>	Program address detection register 1	PADR0	R/W		XXXXXXXX <sub>B</sub>
001FF2 <sub>H</sub>	Program address detection register 2	PADR0	R/W		XXXXXXXX <sub>B</sub>
001FF3 <sub>H</sub>	Program address detection register 3	PADR1	R/W		XXXXXXXX <sub>B</sub>
001FF4 <sub>H</sub>	Program address detection register 4	PADR1	R/W		XXXXXXXX <sub>B</sub>
001FF5 <sub>H</sub>	Program address detection register 5	PADR1	R/W		XXXXXXXX <sub>B</sub>

(Continued)

# MB90920 Series

Address	Register name	Symbol	Read/write	Resource name	Initial value
003700 <sub>H</sub> to 0037FF <sub>H</sub>	Area reserved for CAN Controller 2. Refer to "■ CAN CONTROLLERS"				
003800 <sub>H</sub> to 0038FF <sub>H</sub>	Area reserved for CAN Controller 3. Refer to "■ CAN CONTROLLERS"				
003900 <sub>H</sub> to 00391F <sub>H</sub>	(Disabled)				
003920 <sub>H</sub>	PPG0 down counter register	PDCR0	R	16-bit PPG0	11111111 <sub>B</sub>
003921 <sub>H</sub>					11111111 <sub>B</sub>
003922 <sub>H</sub>	PPG0 cycle setting register	PCSR0	W		11111111 <sub>B</sub>
003923 <sub>H</sub>					11111111 <sub>B</sub>
003924 <sub>H</sub>	PPG0 duty setting register	PDUT0	W	16-bit PPG0	00000000 <sub>B</sub>
003925 <sub>H</sub>					00000000 <sub>B</sub>
003926 <sub>H</sub>	PPG0 output division setting register	PPGDIV0	R/W, R		11111100 <sub>B</sub>
003927 <sub>H</sub>	(Disabled)				
003928 <sub>H</sub>	PPG1 down counter register	PDCR1	R	16-bit PPG1	11111111 <sub>B</sub>
003929 <sub>H</sub>					11111111 <sub>B</sub>
00392A <sub>H</sub>	PPG1 cycle setting register	PCSR1	W		11111111 <sub>B</sub>
00392B <sub>H</sub>					11111111 <sub>B</sub>
00392C <sub>H</sub>	PPG1 duty setting register	PDUT1	W		00000000 <sub>B</sub>
00392D <sub>H</sub>					00000000 <sub>B</sub>
00392E <sub>H</sub>	PPG1 output division setting register	PPGDIV1	R/W, R	11111100 <sub>B</sub>	
00392F <sub>H</sub>	(Disabled)				
003930 <sub>H</sub>	PPG2 down counter register	PDCR2	R	16-bit PPG2	11111111 <sub>B</sub>
003931 <sub>H</sub>					11111111 <sub>B</sub>
003932 <sub>H</sub>	PPG2 cycle setting register	PCSR2	W		11111111 <sub>B</sub>
003933 <sub>H</sub>					11111111 <sub>B</sub>
003934 <sub>H</sub>	PPG2 duty setting register	PDUT2	W		00000000 <sub>B</sub>
003935 <sub>H</sub>					00000000 <sub>B</sub>
003936 <sub>H</sub>	PPG2 output division setting register	PPGDIV2	R/W, R	11111100 <sub>B</sub>	
003937 <sub>H</sub> to 00393F <sub>H</sub>	(Disabled)				
003940 <sub>H</sub>	Input capture register 4	IPCP4	R	Input capture 4/5	XXXXXXXX <sub>B</sub>
003941 <sub>H</sub>					XXXXXXXX <sub>B</sub>
003942 <sub>H</sub>	Input capture register 5	IPCP5	R		XXXXXXXX <sub>B</sub>
003943 <sub>H</sub>					XXXXXXXX <sub>B</sub>

(Continued)

# MB90920 Series

Address	Register name	Symbol	Read/write	Resource name	Initial value
003944 <sub>H</sub>	Input capture register 6	IPCP6	R	Input capture 6/7	XXXXXXXX <sub>B</sub>
003945 <sub>H</sub>					XXXXXXXX <sub>B</sub>
003946 <sub>H</sub>	Input capture register 7	IPCP7	R		XXXXXXXX <sub>B</sub>
003947 <sub>H</sub>					XXXXXXXX <sub>B</sub>
003948 <sub>H</sub> to 00394F <sub>H</sub>	(Disabled)				
003950 <sub>H</sub>	Minute data register 2/Reload register 2	TMR2/ TMRLR2	R/W	16-bit reload timer 2	XXXXXXXX <sub>B</sub>
003951 <sub>H</sub>					XXXXXXXX <sub>B</sub>
003952 <sub>H</sub>	Minute data register 3/Reload register 3	TMR3/ TMRLR3	R/W	16-bit reload timer 3	XXXXXXXX <sub>B</sub>
003953 <sub>H</sub>					XXXXXXXX <sub>B</sub>
003954 <sub>H</sub> to 003957 <sub>H</sub>	(Disabled)				
003958 <sub>H</sub>	Sub second data register	WTBR	R/W	Real time watch timer	XXXXXXXX <sub>B</sub>
003959 <sub>H</sub>					XXXXXXXX <sub>B</sub>
00395A <sub>H</sub>					XXXXXXXX <sub>B</sub>
00395B <sub>H</sub>	Second data register	WTSR	R/W		XX000000 <sub>B</sub>
00395C <sub>H</sub>	Minute data register	WTMR	R/W		XX000000 <sub>B</sub>
00395D <sub>H</sub>	Hour data register	WTHR	R/W		XXX00000 <sub>B</sub>
00395E <sub>H</sub>	Day data register	WTDR	R/W		00X00001 <sub>B</sub>
00395F <sub>H</sub>	(Disabled)				
003960 <sub>H</sub>	LCD display RAM	VRAM	R/W	LCD controller/ driver	XXXXXXXX <sub>B</sub>
003961 <sub>H</sub>					XXXXXXXX <sub>B</sub>
003962 <sub>H</sub>					XXXXXXXX <sub>B</sub>
003963 <sub>H</sub>					XXXXXXXX <sub>B</sub>
003964 <sub>H</sub>					XXXXXXXX <sub>B</sub>
003965 <sub>H</sub>					XXXXXXXX <sub>B</sub>
003966 <sub>H</sub>					XXXXXXXX <sub>B</sub>
003967 <sub>H</sub>					XXXXXXXX <sub>B</sub>
003968 <sub>H</sub>					XXXXXXXX <sub>B</sub>
003969 <sub>H</sub>					XXXXXXXX <sub>B</sub>
00396A <sub>H</sub>					XXXXXXXX <sub>B</sub>
00396B <sub>H</sub>					XXXXXXXX <sub>B</sub>
00396C <sub>H</sub>					XXXXXXXX <sub>B</sub>
00396D <sub>H</sub>					XXXXXXXX <sub>B</sub>
00396E <sub>H</sub>					XXXXXXXX <sub>B</sub>
00396F <sub>H</sub>	XXXXXXXX <sub>B</sub>				

(Continued)

# MB90920 Series

Address	Register name	Symbol	Read/write	Resource name	Initial value
003970 <sub>H</sub> to 003973 <sub>H</sub>	(Disabled)				
003974 <sub>H</sub>	Frequency data register 1	SGFR1	R/W	Sound generator 1	XXXXXXXX <sub>B</sub>
003975 <sub>H</sub>	Amplitude data register 1	SGAR1	R/W		0000000 <sub>B</sub>
003976 <sub>H</sub>	Decrement grade register 1	SGDR1	R/W		XXXXXXXX <sub>B</sub>
003977 <sub>H</sub>	Tone count register 1	SGTR1	R/W		XXXXXXXX <sub>B</sub>
003978 <sub>H</sub> to 00397F <sub>H</sub>	(Disabled)				
003980 <sub>H</sub>	PWM1 compare register 0	PWC10	R/W	Stepping motor controller 0	XXXXXXXX <sub>B</sub>
003981 <sub>H</sub>					XXXXXXXX <sub>B</sub>
003982 <sub>H</sub>	PWM2 compare register 0	PWC20	R/W		XXXXXXXX <sub>B</sub>
003983 <sub>H</sub>					XXXXXXXX <sub>B</sub>
003984 <sub>H</sub>	PWM1 select register 0	PWS10	R/W		0000000 <sub>B</sub>
003985 <sub>H</sub>	PWM2 select register 0	PWS20	R/W		X000000 <sub>B</sub>
003986 <sub>H</sub> , 003987 <sub>H</sub>	(Disabled)				
003988 <sub>H</sub>	PWM1 compare register 1	PWC11	R/W	Stepping motor controller 1	XXXXXXXX <sub>B</sub>
003989 <sub>H</sub>					XXXXXXXX <sub>B</sub>
00398A <sub>H</sub>	PWM2 compare register 1	PWC21	R/W		XXXXXXXX <sub>B</sub>
00398B <sub>H</sub>					XXXXXXXX <sub>B</sub>
00398C <sub>H</sub>	PWM1 select register 1	PWS11	R/W		0000000 <sub>B</sub>
00398D <sub>H</sub>	PWM2 select register 1	PWS21	R/W		X000000 <sub>B</sub>
00398E <sub>H</sub> , 00398F <sub>H</sub>	(Disabled)				
003990 <sub>H</sub>	PWM1 compare register 2	PWC12	R/W	Stepping motor controller 2	XXXXXXXX <sub>B</sub>
003991 <sub>H</sub>					XXXXXXXX <sub>B</sub>
003992 <sub>H</sub>	PWM2 compare register 2	PWC22	R/W		XXXXXXXX <sub>B</sub>
003993 <sub>H</sub>					XXXXXXXX <sub>B</sub>
003994 <sub>H</sub>	PWM1 select register 2	PWS12	R/W		0000000 <sub>B</sub>
003995 <sub>H</sub>	PWM2 select register 2	PWS22	R/W		X000000 <sub>B</sub>
003996 <sub>H</sub> , 003997 <sub>H</sub>	(Disabled)				

(Continued)



# MB90920 Series

(Continued)

Address	Register name	Symbol	Read/write	Resource name	Initial value
003998 <sub>H</sub>	PWM1 compare register 3	PWC13	R/W	Stepping motor controller 3	XXXXXXXX <sub>B</sub>
003999 <sub>H</sub>					XXXXXXXX <sub>B</sub>
00399A <sub>H</sub>	PWM2 compare register 3	PWC23	R/W		XXXXXXXX <sub>B</sub>
00399B <sub>H</sub>					XXXXXXXX <sub>B</sub>
00399C <sub>H</sub>	PWM1 select register 3	PWS13	R/W		00000000 <sub>B</sub>
00399D <sub>H</sub>	PWM2 select register 3	PWS23	R/W		X0000000 <sub>B</sub>
00399E <sub>H</sub> to 0039A5 <sub>H</sub>	(Disabled)				
0039A6 <sub>H</sub>	Flash write control register 0	FWR0	R/W	Flash I/F	00000000 <sub>B</sub>
0039A7 <sub>H</sub>	Flash write control register 1	FWR1			00000000 <sub>B</sub>
0039A8 <sub>H</sub> to 0039BF <sub>H</sub>	(Disabled)				
0039C0 <sub>H</sub> to 0039DF <sub>H</sub>	Area reserved for CAN Controller 2. Refer to “■ CAN CONTROLLERS”				
0039E0 <sub>H</sub> to 0039FF <sub>H</sub>	Area reserved for CAN Controller 3. Refer to “■ CAN CONTROLLERS”				
003A00 <sub>H</sub> to 003AFF <sub>H</sub>	Area reserved for CAN Controller 0. Refer to “■ CAN CONTROLLERS”				
003B00 <sub>H</sub> to 003BFF <sub>H</sub>	Area reserved for CAN Controller 1. Refer to “■ CAN CONTROLLERS”				
003C00 <sub>H</sub> to 003CFF <sub>H</sub>	Area reserved for CAN Controller 0. Refer to “■ CAN CONTROLLERS”				
003D00 <sub>H</sub> to 003DFF <sub>H</sub>	Area reserved for CAN Controller 1. Refer to “■ CAN CONTROLLERS”				
003E00 <sub>H</sub> to 003EFF <sub>H</sub>	Area reserved for CAN Controller 2. Refer to “■ CAN CONTROLLERS”				
003F00 <sub>H</sub> to 003FFF <sub>H</sub>	Area reserved for CAN Controller 3. Refer to “■ CAN CONTROLLERS”				

## ■ CAN CONTROLLERS

The CAN controller has the following features :

- Conforms to CAN Specification Version 2.0 Part A and B
  - Supports transmission/reception in standard frame and extended frame formats
- Supports transmission of data frames by receiving remote frames
- 16 transmission/reception message buffers
  - 29-bit ID and 8-byte data
  - Multi-level message buffer configuration
- Provides full-bit comparison, full-bit mask, acceptance register 0/acceptance register 1 for each message buffer as ID acceptance mask
  - 2 acceptance mask registers in either standard frame format or extended frame formats
- Bit rate programmable from 10 kbps to 2 Mbps (when input clock is at 16 MHz)

**List of Control Registers(1)**

Address				Register	Abbreviation	Access	Initial Value
CAN0	CAN1	CAN2	CAN3				
003C00 <sub>H</sub>	003D00 <sub>H</sub>	003E00 <sub>H</sub>	003F00 <sub>H</sub>	Control status register	CSR	R/W, R	00---000 <sub>B</sub> 0----0-1 <sub>B</sub>
003C01 <sub>H</sub>	003D01 <sub>H</sub>	003E01 <sub>H</sub>	003F01 <sub>H</sub>				
003C02 <sub>H</sub>	003D02 <sub>H</sub>	003E02 <sub>H</sub>	003F02 <sub>H</sub>	Last event indicator register	LEIR	R/W	----- <sub>B</sub> 000-0000 <sub>B</sub>
003C03 <sub>H</sub>	003D03 <sub>H</sub>	003E03 <sub>H</sub>	003F03 <sub>H</sub>				
003C04 <sub>H</sub>	003D04 <sub>H</sub>	003E04 <sub>H</sub>	003F04 <sub>H</sub>	RX/TX error counter	RTEC	R	00000000 <sub>B</sub> 00000000 <sub>B</sub>
003C05 <sub>H</sub>	003D05 <sub>H</sub>	003E05 <sub>H</sub>	003F05 <sub>H</sub>				
003C06 <sub>H</sub>	003D06 <sub>H</sub>	003E06 <sub>H</sub>	003F06 <sub>H</sub>	Bit timing register	BTR	R/W	-1111111 <sub>B</sub> 11111111 <sub>B</sub>
003C07 <sub>H</sub>	003D07 <sub>H</sub>	003E07 <sub>H</sub>	003F07 <sub>H</sub>				

# MB90920 Series

List of Control Registers(2)

Address				Register	Abbreviation	Access	Initial Value
CAN0	CAN1	CAN2	CAN3				
000040 <sub>H</sub>	000070 <sub>H</sub>	0039C0 <sub>H</sub>	0039D0 <sub>H</sub>	Message buffer valid register	BVALR	R/W	00000000 <sub>B</sub> 00000000 <sub>B</sub>
000041 <sub>H</sub>	000071 <sub>H</sub>	0039C1 <sub>H</sub>	0039D1 <sub>H</sub>				
000042 <sub>H</sub>	000072 <sub>H</sub>	0039C2 <sub>H</sub>	0039D2 <sub>H</sub>	Transmit request register	TREQR	R/W	00000000 <sub>B</sub> 00000000 <sub>B</sub>
000043 <sub>H</sub>	000073 <sub>H</sub>	0039C3 <sub>H</sub>	0039D3 <sub>H</sub>				
000044 <sub>H</sub>	000074 <sub>H</sub>	0039C4 <sub>H</sub>	0039D4 <sub>H</sub>	Transmit cancel register	TCANR	W	00000000 <sub>B</sub> 00000000 <sub>B</sub>
000045 <sub>H</sub>	000075 <sub>H</sub>	0039C5 <sub>H</sub>	0039D5 <sub>H</sub>				
000046 <sub>H</sub>	000076 <sub>H</sub>	0039C6 <sub>H</sub>	0039D6 <sub>H</sub>	Transmit complete register	TCR	R/W	00000000 <sub>B</sub> 00000000 <sub>B</sub>
000047 <sub>H</sub>	000077 <sub>H</sub>	0039C7 <sub>H</sub>	0039D7 <sub>H</sub>				
000048 <sub>H</sub>	000078 <sub>H</sub>	0039C8 <sub>H</sub>	0039D8 <sub>H</sub>	Receive complete register	RCR	R/W	00000000 <sub>B</sub> 00000000 <sub>B</sub>
000049 <sub>H</sub>	000079 <sub>H</sub>	0039C9 <sub>H</sub>	0039D9 <sub>H</sub>				
00004A <sub>H</sub>	00007A <sub>H</sub>	0039CA <sub>H</sub>	0039DA <sub>H</sub>	Remote request receive register	RRTRR	R/W	00000000 <sub>B</sub> 00000000 <sub>B</sub>
00004B <sub>H</sub>	00007B <sub>H</sub>	0039CB <sub>H</sub>	0039DB <sub>H</sub>				
00004C <sub>H</sub>	00007C <sub>H</sub>	0039CC <sub>H</sub>	0039DC <sub>H</sub>	Receive overrun register	ROVRR	R/W	00000000 <sub>B</sub> 00000000 <sub>B</sub>
00004D <sub>H</sub>	00007D <sub>H</sub>	0039CD <sub>H</sub>	0039DD <sub>H</sub>				
00004E <sub>H</sub>	00007E <sub>H</sub>	0039CE <sub>H</sub>	0039DE <sub>H</sub>	Receive interrupt enable register	RIER	R/W	00000000 <sub>B</sub> 00000000 <sub>B</sub>
00004F <sub>H</sub>	00007F <sub>H</sub>	0039CF <sub>H</sub>	0039DF <sub>H</sub>				
003C08 <sub>H</sub>	003D08 <sub>H</sub>	003E08 <sub>H</sub>	003F08 <sub>H</sub>	IDE register	IDER	R/W	XXXXXXXX <sub>B</sub>
003C09 <sub>H</sub>	003D09 <sub>H</sub>	003E09 <sub>H</sub>	003F09 <sub>H</sub>				XXXXXXXX <sub>B</sub>
003C0A <sub>H</sub>	003D0A <sub>H</sub>	003E0A <sub>H</sub>	003F0A <sub>H</sub>	Transmit RTR register	TRTRR	R/W	00000000 <sub>B</sub>
003C0B <sub>H</sub>	003D0B <sub>H</sub>	003E0B <sub>H</sub>	003F0B <sub>H</sub>				00000000 <sub>B</sub>
003C0C <sub>H</sub>	003D0C <sub>H</sub>	003E0C <sub>H</sub>	003F0C <sub>H</sub>	Remote frame receive wait register	RFWTR	R/W	XXXXXXXX <sub>B</sub> XXXXXXXX <sub>B</sub>
003C0D <sub>H</sub>	003D0D <sub>H</sub>	003E0D <sub>H</sub>	003F0D <sub>H</sub>				
003C0E <sub>H</sub>	003D0E <sub>H</sub>	003E0E <sub>H</sub>	003F0E <sub>H</sub>	Transmit interrupt enable register	TIER	R/W	00000000 <sub>B</sub> 00000000 <sub>B</sub>
003C0F <sub>H</sub>	003D0F <sub>H</sub>	003E0F <sub>H</sub>	003F0F <sub>H</sub>				
003C10 <sub>H</sub>	003D10 <sub>H</sub>	003E10 <sub>H</sub>	003F10 <sub>H</sub>	Acceptance mask select register	AMSR	R/W	XXXXXXXX <sub>B</sub> XXXXXXXX <sub>B</sub>
003C11 <sub>H</sub>	003D11 <sub>H</sub>	003E11 <sub>H</sub>	003F11 <sub>H</sub>				XXXXXXXX <sub>B</sub> XXXXXXXX <sub>B</sub>
003C12 <sub>H</sub>	003D12 <sub>H</sub>	003E12 <sub>H</sub>	003F12 <sub>H</sub>				XXXXXXXX <sub>B</sub> XXXXXXXX <sub>B</sub>
003C13 <sub>H</sub>	003D13 <sub>H</sub>	003E13 <sub>H</sub>	003F13 <sub>H</sub>				XXXXXXXX <sub>B</sub> XXXXXXXX <sub>B</sub>
003C14 <sub>H</sub>	003D14 <sub>H</sub>	003E14 <sub>H</sub>	003F14 <sub>H</sub>	Acceptance mask register 0	AMR0	R/W	XXXXXXXX <sub>B</sub> XXXXXXXX <sub>B</sub>
003C15 <sub>H</sub>	003D15 <sub>H</sub>	003E15 <sub>H</sub>	003F15 <sub>H</sub>				XXXXXX--- <sub>B</sub> XXXXXXXX <sub>B</sub>
003C16 <sub>H</sub>	003D16 <sub>H</sub>	003E16 <sub>H</sub>	003F16 <sub>H</sub>				XXXXXX--- <sub>B</sub> XXXXXXXX <sub>B</sub>
003C17 <sub>H</sub>	003D17 <sub>H</sub>	003E17 <sub>H</sub>	003F17 <sub>H</sub>				XXXXXX--- <sub>B</sub> XXXXXXXX <sub>B</sub>
003C18 <sub>H</sub>	003D18 <sub>H</sub>	003E18 <sub>H</sub>	003F18 <sub>H</sub>	Acceptance mask register 1	AMR1	R/W	XXXXXXXX <sub>B</sub> XXXXXXXX <sub>B</sub>
003C19 <sub>H</sub>	003D19 <sub>H</sub>	003E19 <sub>H</sub>	003F19 <sub>H</sub>				XXXXXX--- <sub>B</sub> XXXXXXXX <sub>B</sub>
003C1A <sub>H</sub>	003D1A <sub>H</sub>	003E1A <sub>H</sub>	003F1A <sub>H</sub>				XXXXXX--- <sub>B</sub> XXXXXXXX <sub>B</sub>
003C1B <sub>H</sub>	003D1B <sub>H</sub>	003E1B <sub>H</sub>	003F1B <sub>H</sub>				XXXXXX--- <sub>B</sub> XXXXXXXX <sub>B</sub>

List of Message Buffers (ID Registers)

Address				Register	Abbreviation	Access	Initial Value
CAN0	CAN1	CAN2	CAN3				
003A00 <sub>H</sub> to 003A1F <sub>H</sub>	003B00 <sub>H</sub> to 003B1F <sub>H</sub>	003700 <sub>H</sub> to 00371F <sub>H</sub>	003800 <sub>H</sub> to 00381F <sub>H</sub>	General-purpose RAM	—	R/W	XXXXXXXX <sub>B</sub> to XXXXXXXX <sub>B</sub>
003A20 <sub>H</sub>	003B20 <sub>H</sub>	003720 <sub>H</sub>	003820 <sub>H</sub>	ID register 0	IDR0	R/W	XXXXXXXX <sub>B</sub> XXXXXXXX <sub>B</sub>
003A21 <sub>H</sub>	003B21 <sub>H</sub>	003721 <sub>H</sub>	003821 <sub>H</sub>				XXXXX--- <sub>B</sub> XXXXXXXX <sub>B</sub>
003A22 <sub>H</sub>	003B22 <sub>H</sub>	003722 <sub>H</sub>	003822 <sub>H</sub>				
003A23 <sub>H</sub>	003B23 <sub>H</sub>	003723 <sub>H</sub>	003823 <sub>H</sub>				
003A24 <sub>H</sub>	003B24 <sub>H</sub>	003724 <sub>H</sub>	003824 <sub>H</sub>	ID register 1	IDR1	R/W	XXXXXXXX <sub>B</sub> XXXXXXXX <sub>B</sub>
003A25 <sub>H</sub>	003B25 <sub>H</sub>	003725 <sub>H</sub>	003825 <sub>H</sub>				XXXXX--- <sub>B</sub> XXXXXXXX <sub>B</sub>
003A26 <sub>H</sub>	003B26 <sub>H</sub>	003726 <sub>H</sub>	003826 <sub>H</sub>				
003A27 <sub>H</sub>	003B27 <sub>H</sub>	003727 <sub>H</sub>	003827 <sub>H</sub>				
003A28 <sub>H</sub>	003B28 <sub>H</sub>	003728 <sub>H</sub>	003828 <sub>H</sub>	ID register 2	IDR2	R/W	XXXXXXXX <sub>B</sub> XXXXXXXX <sub>B</sub>
003A29 <sub>H</sub>	003B29 <sub>H</sub>	003729 <sub>H</sub>	003829 <sub>H</sub>				XXXXX--- <sub>B</sub> XXXXXXXX <sub>B</sub>
003A2A <sub>H</sub>	003B2A <sub>H</sub>	00372A <sub>H</sub>	00382A <sub>H</sub>				
003A2B <sub>H</sub>	003B2B <sub>H</sub>	00372B <sub>H</sub>	00382B <sub>H</sub>				
003A2C <sub>H</sub>	003B2C <sub>H</sub>	00372C <sub>H</sub>	00382C <sub>H</sub>	ID register 3	IDR3	R/W	XXXXXXXX <sub>B</sub> XXXXXXXX <sub>B</sub>
003A2D <sub>H</sub>	003B2D <sub>H</sub>	00372D <sub>H</sub>	00382D <sub>H</sub>				XXXXX--- <sub>B</sub> XXXXXXXX <sub>B</sub>
003A2E <sub>H</sub>	003B2E <sub>H</sub>	00372E <sub>H</sub>	00382E <sub>H</sub>				
003A2F <sub>H</sub>	003B2F <sub>H</sub>	00372F <sub>H</sub>	00382F <sub>H</sub>				
003A30 <sub>H</sub>	003B30 <sub>H</sub>	003730 <sub>H</sub>	003830 <sub>H</sub>	ID register 4	IDR4	R/W	XXXXXXXX <sub>B</sub> XXXXXXXX <sub>B</sub>
003A31 <sub>H</sub>	003B31 <sub>H</sub>	003731 <sub>H</sub>	003831 <sub>H</sub>				XXXXX--- <sub>B</sub> XXXXXXXX <sub>B</sub>
003A32 <sub>H</sub>	003B32 <sub>H</sub>	003732 <sub>H</sub>	003832 <sub>H</sub>				
003A33 <sub>H</sub>	003B33 <sub>H</sub>	003733 <sub>H</sub>	003833 <sub>H</sub>				
003A34 <sub>H</sub>	003B34 <sub>H</sub>	003734 <sub>H</sub>	003834 <sub>H</sub>	ID register 5	IDR5	R/W	XXXXXXXX <sub>B</sub> XXXXXXXX <sub>B</sub>
003A35 <sub>H</sub>	003B35 <sub>H</sub>	003735 <sub>H</sub>	003835 <sub>H</sub>				XXXXX--- <sub>B</sub> XXXXXXXX <sub>B</sub>
003A36 <sub>H</sub>	003B36 <sub>H</sub>	003736 <sub>H</sub>	003836 <sub>H</sub>				
003A37 <sub>H</sub>	003B37 <sub>H</sub>	003737 <sub>H</sub>	003837 <sub>H</sub>				
003A38 <sub>H</sub>	003B38 <sub>H</sub>	003738 <sub>H</sub>	003838 <sub>H</sub>	ID register 6	IDR6	R/W	XXXXXXXX <sub>B</sub> XXXXXXXX <sub>B</sub>
003A39 <sub>H</sub>	003B39 <sub>H</sub>	003739 <sub>H</sub>	003839 <sub>H</sub>				XXXXX--- <sub>B</sub> XXXXXXXX <sub>B</sub>
003A3A <sub>H</sub>	003B3A <sub>H</sub>	00373A <sub>H</sub>	00383A <sub>H</sub>				
003A3B <sub>H</sub>	003B3B <sub>H</sub>	00373B <sub>H</sub>	00383B <sub>H</sub>				
003A3C <sub>H</sub>	003B3C <sub>H</sub>	00373C <sub>H</sub>	00383C <sub>H</sub>	ID register 7	IDR7	R/W	XXXXXXXX <sub>B</sub> XXXXXXXX <sub>B</sub>
003A3D <sub>H</sub>	003B3D <sub>H</sub>	00373D <sub>H</sub>	00383D <sub>H</sub>				XXXXX--- <sub>B</sub> XXXXXXXX <sub>B</sub>
003A3E <sub>H</sub>	003B3E <sub>H</sub>	00373E <sub>H</sub>	00383E <sub>H</sub>				
003A3F <sub>H</sub>	003B3F <sub>H</sub>	00373F <sub>H</sub>	00383F <sub>H</sub>				

(Continued)

# MB90920 Series

(Continued)

Address				Register	Abbreviation	Access	Initial Value
CAN0	CAN1	CAN2	CAN3				
003A40 <sub>H</sub>	003B40 <sub>H</sub>	003740 <sub>H</sub>	003840 <sub>H</sub>	ID register 8	IDR8	R/W	XXXXXXXX <sub>B</sub> XXXXXXXX <sub>B</sub>
003A41 <sub>H</sub>	003B41 <sub>H</sub>	003741 <sub>H</sub>	003841 <sub>H</sub>				
003A42 <sub>H</sub>	003B42 <sub>H</sub>	003742 <sub>H</sub>	003842 <sub>H</sub>				
003A43 <sub>H</sub>	003B43 <sub>H</sub>	003743 <sub>H</sub>	003843 <sub>H</sub>				XXXXX <sub>B</sub> --- XXXXXXXX <sub>B</sub>
003A44 <sub>H</sub>	003B44 <sub>H</sub>	003744 <sub>H</sub>	003844 <sub>H</sub>	ID register 9	IDR9	R/W	XXXXXXXX <sub>B</sub> XXXXXXXX <sub>B</sub>
003A45 <sub>H</sub>	003B45 <sub>H</sub>	003745 <sub>H</sub>	003845 <sub>H</sub>				
003A46 <sub>H</sub>	003B46 <sub>H</sub>	003746 <sub>H</sub>	003846 <sub>H</sub>				
003A47 <sub>H</sub>	003B47 <sub>H</sub>	003747 <sub>H</sub>	003847 <sub>H</sub>				XXXXX <sub>B</sub> --- XXXXXXXX <sub>B</sub>
003A48 <sub>H</sub>	003B48 <sub>H</sub>	003748 <sub>H</sub>	003848 <sub>H</sub>	ID register 10	IDR10	R/W	XXXXXXXX <sub>B</sub> XXXXXXXX <sub>B</sub>
003A49 <sub>H</sub>	003B49 <sub>H</sub>	003749 <sub>H</sub>	003849 <sub>H</sub>				
003A4A <sub>H</sub>	003B4A <sub>H</sub>	00374A <sub>H</sub>	00384A <sub>H</sub>				
003A4B <sub>H</sub>	003B4B <sub>H</sub>	00374B <sub>H</sub>	00384B <sub>H</sub>				XXXXX <sub>B</sub> --- XXXXXXXX <sub>B</sub>
003A4C <sub>H</sub>	003B4C <sub>H</sub>	00374C <sub>H</sub>	00384C <sub>H</sub>	ID register 11	IDR11	R/W	XXXXXXXX <sub>B</sub> XXXXXXXX <sub>B</sub>
003A4D <sub>H</sub>	003B4D <sub>H</sub>	00374D <sub>H</sub>	00384D <sub>H</sub>				
003A4E <sub>H</sub>	003B4E <sub>H</sub>	00374E <sub>H</sub>	00384E <sub>H</sub>				
003A4F <sub>H</sub>	003B4F <sub>H</sub>	00374F <sub>H</sub>	00384F <sub>H</sub>				XXXXX <sub>B</sub> --- XXXXXXXX <sub>B</sub>
003A50 <sub>H</sub>	003B50 <sub>H</sub>	003750 <sub>H</sub>	003850 <sub>H</sub>	ID register 12	IDR12	R/W	XXXXXXXX <sub>B</sub> XXXXXXXX <sub>B</sub>
003A51 <sub>H</sub>	003B51 <sub>H</sub>	003751 <sub>H</sub>	003851 <sub>H</sub>				
003A52 <sub>H</sub>	003B52 <sub>H</sub>	003752 <sub>H</sub>	003852 <sub>H</sub>				
003A53 <sub>H</sub>	003B53 <sub>H</sub>	003753 <sub>H</sub>	003853 <sub>H</sub>				XXXXX <sub>B</sub> --- XXXXXXXX <sub>B</sub>
003A54 <sub>H</sub>	003B54 <sub>H</sub>	003754 <sub>H</sub>	003854 <sub>H</sub>	ID register 13	IDR13	R/W	XXXXXXXX <sub>B</sub> XXXXXXXX <sub>B</sub>
003A55 <sub>H</sub>	003B55 <sub>H</sub>	003755 <sub>H</sub>	003855 <sub>H</sub>				
003A56 <sub>H</sub>	003B56 <sub>H</sub>	003756 <sub>H</sub>	003856 <sub>H</sub>				
003A57 <sub>H</sub>	003B57 <sub>H</sub>	003757 <sub>H</sub>	003857 <sub>H</sub>				XXXXX <sub>B</sub> --- XXXXXXXX <sub>B</sub>
003A58 <sub>H</sub>	003B58 <sub>H</sub>	003758 <sub>H</sub>	003858 <sub>H</sub>	ID register 14	IDR14	R/W	XXXXXXXX <sub>B</sub> XXXXXXXX <sub>B</sub>
003A59 <sub>H</sub>	003B59 <sub>H</sub>	003759 <sub>H</sub>	003859 <sub>H</sub>				
003A5A <sub>H</sub>	003B5A <sub>H</sub>	00375A <sub>H</sub>	00385A <sub>H</sub>				
003A5B <sub>H</sub>	003B5B <sub>H</sub>	00375B <sub>H</sub>	00385B <sub>H</sub>				XXXXX <sub>B</sub> --- XXXXXXXX <sub>B</sub>
003A5C <sub>H</sub>	003B5C <sub>H</sub>	00375C <sub>H</sub>	00385C <sub>H</sub>	ID register 15	IDR15	R/W	XXXXXXXX <sub>B</sub> XXXXXXXX <sub>B</sub>
003A5D <sub>H</sub>	003B5D <sub>H</sub>	00375D <sub>H</sub>	00385D <sub>H</sub>				
003A5E <sub>H</sub>	003B5E <sub>H</sub>	00375E <sub>H</sub>	00385E <sub>H</sub>				
003A5F <sub>H</sub>	003B5F <sub>H</sub>	00375F <sub>H</sub>	00385F <sub>H</sub>				XXXXX <sub>B</sub> --- XXXXXXXX <sub>B</sub>

List of Message Buffers (DLC Registers)

Address				Register	Abbreviation	Access	Initial Value
CAN0	CAN1	CAN2	CAN3				
003A60 <sub>H</sub>	003B60 <sub>H</sub>	003760 <sub>H</sub>	003860 <sub>H</sub>	DLC register 0	DLCR0	R/W	----XXXX <sub>B</sub>
003A61 <sub>H</sub>	003B61 <sub>H</sub>	003761 <sub>H</sub>	003861 <sub>H</sub>				
003A62 <sub>H</sub>	003B62 <sub>H</sub>	003762 <sub>H</sub>	003862 <sub>H</sub>	DLC register 1	DLCR1	R/W	----XXXX <sub>B</sub>
003A63 <sub>H</sub>	003B63 <sub>H</sub>	003763 <sub>H</sub>	003863 <sub>H</sub>				
003A64 <sub>H</sub>	003B64 <sub>H</sub>	003764 <sub>H</sub>	003864 <sub>H</sub>	DLC register 2	DLCR2	R/W	----XXXX <sub>B</sub>
003A65 <sub>H</sub>	003B65 <sub>H</sub>	003765 <sub>H</sub>	003865 <sub>H</sub>				
003A66 <sub>H</sub>	003B66 <sub>H</sub>	003766 <sub>H</sub>	003866 <sub>H</sub>	DLC register 3	DLCR3	R/W	----XXXX <sub>B</sub>
003A67 <sub>H</sub>	003B67 <sub>H</sub>	003767 <sub>H</sub>	003867 <sub>H</sub>				
003A68 <sub>H</sub>	003B68 <sub>H</sub>	003768 <sub>H</sub>	003868 <sub>H</sub>	DLC register 4	DLCR4	R/W	----XXXX <sub>B</sub>
003A69 <sub>H</sub>	003B69 <sub>H</sub>	003769 <sub>H</sub>	003869 <sub>H</sub>				
003A6A <sub>H</sub>	003B6A <sub>H</sub>	00376A <sub>H</sub>	00386A <sub>H</sub>	DLC register 5	DLCR5	R/W	----XXXX <sub>B</sub>
003A6B <sub>H</sub>	003B6B <sub>H</sub>	00376B <sub>H</sub>	00386B <sub>H</sub>				
003A6C <sub>H</sub>	003B6C <sub>H</sub>	00376C <sub>H</sub>	00386C <sub>H</sub>	DLC register 6	DLCR6	R/W	----XXXX <sub>B</sub>
003A6D <sub>H</sub>	003B6D <sub>H</sub>	00376D <sub>H</sub>	00386D <sub>H</sub>				
003A6E <sub>H</sub>	003B6E <sub>H</sub>	00376E <sub>H</sub>	00386E <sub>H</sub>	DLC register 7	DLCR7	R/W	----XXXX <sub>B</sub>
003A6F <sub>H</sub>	003B6F <sub>H</sub>	00376F <sub>H</sub>	00386F <sub>H</sub>				
003A70 <sub>H</sub>	003B70 <sub>H</sub>	003770 <sub>H</sub>	003870 <sub>H</sub>	DLC register 8	DLCR8	R/W	----XXXX <sub>B</sub>
003A71 <sub>H</sub>	003B71 <sub>H</sub>	003771 <sub>H</sub>	003871 <sub>H</sub>				
003A72 <sub>H</sub>	003B72 <sub>H</sub>	003772 <sub>H</sub>	003872 <sub>H</sub>	DLC register 9	DLCR9	R/W	----XXXX <sub>B</sub>
003A73 <sub>H</sub>	003B73 <sub>H</sub>	003773 <sub>H</sub>	003873 <sub>H</sub>				
003A74 <sub>H</sub>	003B74 <sub>H</sub>	003774 <sub>H</sub>	003874 <sub>H</sub>	DLC register 10	DLCR10	R/W	----XXXX <sub>B</sub>
003A75 <sub>H</sub>	003B75 <sub>H</sub>	003775 <sub>H</sub>	003875 <sub>H</sub>				
003A76 <sub>H</sub>	003B76 <sub>H</sub>	003776 <sub>H</sub>	003876 <sub>H</sub>	DLC register 11	DLCR11	R/W	----XXXX <sub>B</sub>
003A77 <sub>H</sub>	003B77 <sub>H</sub>	003777 <sub>H</sub>	003877 <sub>H</sub>				
003A78 <sub>H</sub>	003B78 <sub>H</sub>	003778 <sub>H</sub>	003878 <sub>H</sub>	DLC register 12	DLCR12	R/W	----XXXX <sub>B</sub>
003A79 <sub>H</sub>	003B79 <sub>H</sub>	003779 <sub>H</sub>	003879 <sub>H</sub>				
003A7A <sub>H</sub>	003B7A <sub>H</sub>	00377A <sub>H</sub>	00387A <sub>H</sub>	DLC register 13	DLCR13	R/W	----XXXX <sub>B</sub>
003A7B <sub>H</sub>	003B7B <sub>H</sub>	00377B <sub>H</sub>	00387B <sub>H</sub>				
003A7C <sub>H</sub>	003B7C <sub>H</sub>	00377C <sub>H</sub>	00387C <sub>H</sub>	DLC register 14	DLCR14	R/W	----XXXX <sub>B</sub>
003A7D <sub>H</sub>	003B7D <sub>H</sub>	00377D <sub>H</sub>	00387D <sub>H</sub>				
003A7E <sub>H</sub>	003B7E <sub>H</sub>	00377E <sub>H</sub>	00387E <sub>H</sub>	DLC register 15	DLCR15	R/W	----XXXX <sub>B</sub>
003A7F <sub>H</sub>	003B7F <sub>H</sub>	00377F <sub>H</sub>	00387F <sub>H</sub>				

# MB90920 Series

List of Message Buffers (Data register)

Address				Register	Abbreviation	Access	Initial Value
CAN0	CAN1	CAN2	CAN3				
003A80 <sub>H</sub> to 003A87 <sub>H</sub>	003B80 <sub>H</sub> to 003B87 <sub>H</sub>	003780 <sub>H</sub> to 003787 <sub>H</sub>	003880 <sub>H</sub> to 003887 <sub>H</sub>	Data register 0 (8 bytes)	DTR0	R/W	XXXXXXXX <sub>B</sub> to XXXXXXXX <sub>B</sub>
003A88 <sub>H</sub> to 003A8F <sub>H</sub>	003B88 <sub>H</sub> to 003B8F <sub>H</sub>	003788 <sub>H</sub> to 00378F <sub>H</sub>	003888 <sub>H</sub> to 00388F <sub>H</sub>	Data register 1 (8 bytes)	DTR1	R/W	XXXXXXXX <sub>B</sub> to XXXXXXXX <sub>B</sub>
003A90 <sub>H</sub> to 003A97 <sub>H</sub>	003B90 <sub>H</sub> to 003B97 <sub>H</sub>	003790 <sub>H</sub> to 003797 <sub>H</sub>	003890 <sub>H</sub> to 003897 <sub>H</sub>	Data register 2 (8 bytes)	DTR2	R/W	XXXXXXXX <sub>B</sub> to XXXXXXXX <sub>B</sub>
003A98 <sub>H</sub> to 003A9F <sub>H</sub>	003B98 <sub>H</sub> to 003B9F <sub>H</sub>	003798 <sub>H</sub> to 00379F <sub>H</sub>	003898 <sub>H</sub> to 00389F <sub>H</sub>	Data register 3 (8 bytes)	DTR3	R/W	XXXXXXXX <sub>B</sub> to XXXXXXXX <sub>B</sub>
003AA0 <sub>H</sub> to 003AA7 <sub>H</sub>	003BA0 <sub>H</sub> to 003BA7 <sub>H</sub>	0037A0 <sub>H</sub> to 0037A7 <sub>H</sub>	0038A0 <sub>H</sub> to 0038A7 <sub>H</sub>	Data register 4 (8 bytes)	DTR4	R/W	XXXXXXXX <sub>B</sub> to XXXXXXXX <sub>B</sub>
003AA8 <sub>H</sub> to 003AAF <sub>H</sub>	003BA8 <sub>H</sub> to 003BAF <sub>H</sub>	0037A8 <sub>H</sub> to 0037AF <sub>H</sub>	0038A8 <sub>H</sub> to 0038AF <sub>H</sub>	Data register 5 (8 bytes)	DTR5	R/W	XXXXXXXX <sub>B</sub> to XXXXXXXX <sub>B</sub>
003AB0 <sub>H</sub> to 003AB7 <sub>H</sub>	003BB0 <sub>H</sub> to 003BB7 <sub>H</sub>	0037B0 <sub>H</sub> to 0037B7 <sub>H</sub>	0038B0 <sub>H</sub> to 0038B7 <sub>H</sub>	Data register 6 (8 bytes)	DTR6	R/W	XXXXXXXX <sub>B</sub> to XXXXXXXX <sub>B</sub>
003AB8 <sub>H</sub> to 003ABF <sub>H</sub>	003BB8 <sub>H</sub> to 003BBF <sub>H</sub>	0037B8 <sub>H</sub> to 0037BF <sub>H</sub>	0038B8 <sub>H</sub> to 0038BF <sub>H</sub>	Data register 7 (8 bytes)	DTR7	R/W	XXXXXXXX <sub>B</sub> to XXXXXXXX <sub>B</sub>
003AC0 <sub>H</sub> to 003AC7 <sub>H</sub>	003BC0 <sub>H</sub> to 003BC7 <sub>H</sub>	0037C0 <sub>H</sub> to 0037C7 <sub>H</sub>	0038C0 <sub>H</sub> to 0038C7 <sub>H</sub>	Data register 8 (8 bytes)	DTR8	R/W	XXXXXXXX <sub>B</sub> to XXXXXXXX <sub>B</sub>
003AC8 <sub>H</sub> to 003ACF <sub>H</sub>	003BC8 <sub>H</sub> to 003BCF <sub>H</sub>	0037C8 <sub>H</sub> to 0037CF <sub>H</sub>	0038C8 <sub>H</sub> to 0038CF <sub>H</sub>	Data register 9 (8 bytes)	DTR9	R/W	XXXXXXXX <sub>B</sub> to XXXXXXXX <sub>B</sub>
003AD0 <sub>H</sub> to 003AD7 <sub>H</sub>	003BD0 <sub>H</sub> to 003BD7 <sub>H</sub>	0037D0 <sub>H</sub> to 0037D7 <sub>H</sub>	0038D0 <sub>H</sub> to 0038D7 <sub>H</sub>	Data register 10 (8 bytes)	DTR10	R/W	XXXXXXXX <sub>B</sub> to XXXXXXXX <sub>B</sub>
003AD8 <sub>H</sub> to 003ADF <sub>H</sub>	003BD8 <sub>H</sub> to 003BDF <sub>H</sub>	0037D8 <sub>H</sub> to 0037DF <sub>H</sub>	0038D8 <sub>H</sub> to 0038DF <sub>H</sub>	Data register 11 (8 bytes)	DTR11	R/W	XXXXXXXX <sub>B</sub> to XXXXXXXX <sub>B</sub>
003AE0 <sub>H</sub> to 003AE7 <sub>H</sub>	003BE0 <sub>H</sub> to 003BE7 <sub>H</sub>	0037E0 <sub>H</sub> to 0037E7 <sub>H</sub>	0038E0 <sub>H</sub> to 0038E7 <sub>H</sub>	Data register 12 (8 bytes)	DTR12	R/W	XXXXXXXX <sub>B</sub> to XXXXXXXX <sub>B</sub>
003AE8 <sub>H</sub> to 003AEF <sub>H</sub>	003BE8 <sub>H</sub> to 003BEF <sub>H</sub>	0037E8 <sub>H</sub> to 0037EF <sub>H</sub>	0038E8 <sub>H</sub> to 0038EF <sub>H</sub>	Data register 13 (8 bytes)	DTR13	R/W	XXXXXXXX <sub>B</sub> to XXXXXXXX <sub>B</sub>
003AF0 <sub>H</sub> to 003AF7 <sub>H</sub>	003BF0 <sub>H</sub> to 003BF7 <sub>H</sub>	0037F0 <sub>H</sub> to 0037F7 <sub>H</sub>	0038F0 <sub>H</sub> to 0038F7 <sub>H</sub>	Data register 14 (8 bytes)	DTR14	R/W	XXXXXXXX <sub>B</sub> to XXXXXXXX <sub>B</sub>
003AF8 <sub>H</sub> to 003AFF <sub>H</sub>	003BF8 <sub>H</sub> to 003BFF <sub>H</sub>	0037F8 <sub>H</sub> to 0037FF <sub>H</sub>	0038F8 <sub>H</sub> to 0038FF <sub>H</sub>	Data register 15 (8 bytes)	DTR15	R/W	XXXXXXXX <sub>B</sub> to XXXXXXXX <sub>B</sub>





# MB90920 Series

(Continued)

Interrupt source	EI <sup>2</sup> OS corresponding	Interrupt vector			Interrupt control register		Priority *2
		Number		Address	ICR	Address	
UART 1 RX	◎	#37	25 <sub>H</sub>	FFFF68 <sub>H</sub>	ICR13	0000BD <sub>H</sub> *1	High ↑ ↓ Low
UART 1 TX	△	#38	26 <sub>H</sub>	FFFF64 <sub>H</sub>			
UART 0 RX	◎	#39	27 <sub>H</sub>	FFFF60 <sub>H</sub>	ICR14	0000BE <sub>H</sub> *1	
UART 0 TX	△	#40	28 <sub>H</sub>	FFFF5C <sub>H</sub>			
Flash memory status	×	#41	29 <sub>H</sub>	FFFF58 <sub>H</sub>	ICR15	0000BF <sub>H</sub> *1	
Delay interrupt generator module	×	#42	2A <sub>H</sub>	FFFF54 <sub>H</sub>			

◎ : Usable, and has expanded intelligent I/O services (EI<sup>2</sup>OS) stop function

○ : Usable

△ : Usable when interrupt sources sharing ICR are not in use

×

\*1 : • Peripheral functions that share the ICR register have the same interrupt level.

• If the expanded intelligent I/O service (EI<sup>2</sup>OS) is used with peripheral functions that share the ICR register, only one of the peripheral functions that share the register can be used.

• When the expanded intelligent I/O service (EI<sup>2</sup>OS) is specified for one of the peripheral functions that shares the ICR register, interrupts cannot be used from the other peripheral functions that share the register.

\*2 : Priority applies when interrupts of the same level are generated.

## ■ ELECTRICAL CHARACTERISTICS

### 1. Absolute Maximum Ratings

Parameter	Symbol	Rating		Unit	Remarks
		Min	Max		
Power supply voltage*1	V <sub>CC</sub>	V <sub>SS</sub> - 0.3	V <sub>SS</sub> + 6.0	V	
	AV <sub>CC</sub>	V <sub>SS</sub> - 0.3	V <sub>SS</sub> + 6.0	V	AV <sub>CC</sub> = V <sub>CC</sub> *2
	AVRH	V <sub>SS</sub> - 0.3	V <sub>SS</sub> + 6.0	V	AV <sub>CC</sub> ≥ AVRH*2
	DV <sub>CC</sub>	V <sub>SS</sub> - 0.3	V <sub>SS</sub> + 6.0	V	DV <sub>CC</sub> = V <sub>CC</sub> *2
Input voltage*1	V <sub>I</sub>	V <sub>SS</sub> - 0.3	V <sub>CC</sub> + 0.3	V	*3
Output voltage*1	V <sub>O</sub>	V <sub>SS</sub> - 0.3	V <sub>CC</sub> + 0.3	V	
Maximum clamp current	I <sub>CLAMP</sub>	- 4	+ 4	mA	*7
Total maximum clamp current	Σ  I <sub>CLAMP</sub>	—	40	mA	*7
“L” level maximum output current*4	I <sub>OL1</sub>	—	15	mA	Except P70 to P77 and P80 to P87
	I <sub>OL2</sub>	—	40	mA	P70 to P77 and P80 to P87
“L” level average output current*5	I <sub>OLAV1</sub>	—	4	mA	Except P70 to P77 and P80 to P87
	I <sub>OLAV2</sub>	—	30	mA	P70 to P77 and P80 to P87
“L” level maximum total output current	ΣI <sub>OL1</sub>	—	100	mA	Except P70 to P77 and P80 to P87
	ΣI <sub>OL2</sub>	—	330	mA	P70 to P77 and P80 to P87
“L” level average total output current	ΣI <sub>OLAV1</sub>	—	50	mA	Except P70 to P77 and P80 to P87
	ΣI <sub>OLAV2</sub>	—	250	mA	P70 to P77 and P80 to P87
“H” level maximum output current	I <sub>OH1</sub> *4	—	-15	mA	Except P70 to P77 and P80 to P87
	I <sub>OH2</sub> *4	—	-40	mA	P70 to P77 and P80 to P87
“H” level average output current	I <sub>OHAV1</sub> *5	—	-4	mA	Except P70 to P77 and P80 to P87
	I <sub>OHAV2</sub> *5	—	-30	mA	P70 to P77 and P80 to P87
“H” level maximum total output current	ΣI <sub>OH1</sub>	—	-100	mA	Except P70 to P77 and P80 to P87
	ΣI <sub>OH2</sub>	—	-330	mA	P70 to P77 and P80 to P87
“H” level average total output current	ΣI <sub>OHAV1</sub> *6	—	-50	mA	Except P70 to P77 and P80 to P87
	ΣI <sub>OHAV2</sub> *6	—	-250	mA	P70 to P77 and P80 to P87
Power consumption	P <sub>D</sub>	—	625	mW	
Operating temperature	T <sub>A</sub>	- 40	+ 105	°C	
Storage temperature	T <sub>STG</sub>	- 55	+ 150	°C	

\*1 : The parameter is based on V<sub>SS</sub> = AV<sub>SS</sub> = DV<sub>SS</sub> = 0.0 V.

\*2 : AV<sub>CC</sub>, AVRH must not exceed V<sub>CC</sub>, and AVRH must not exceed AV<sub>CC</sub>.

When using an evaluation product, DV<sub>CC</sub> must not exceed V<sub>CC</sub> (however, DV<sub>CC</sub> can be set to a higher voltage than V<sub>CC</sub> when using a Flash memory product).

\*3 : If the input current or the maximum input current is limited using external components, I<sub>CLAMP</sub> is the applicable rating instead of V<sub>I</sub>.

\*4 : Maximum output current is defined as the peak value of current through any one of the corresponding pins.

(Continued)

# MB90920 Series

(Continued)

- \*5 : Average output current is defined as the average value of the current flowing through any one of the corresponding pins within a period of 100 ms. The “average value” can be calculated by multiplying the “operating current” by the “operating factor”.
- \*6 : Average total output current is defined as the average value of the current flowing through all of the corresponding pins within a period of 100 ms. The “average value” can be calculated by multiplying the “operating current” by the “operating factor”.
- \*7 :
  - Applicable to pins: P10 to P15, P50 to P57, P60 to P67, P70 to P77, P80 to P87, PC0 to PC7, PD0 to PD6, PE0 to PE2
  - Use within recommended operating conditions.
  - Use at DC voltage (current) .
  - The +B signal should always be applied with a limiting resistance placed between the +B signal and the microcontroller.
  - The value of the limiting resistance should be set so that when the +B signal is applied, the input current to the microcontroller pin does not exceed rated values, either instantaneously or for prolonged periods.
  - Note that when the microcontroller drive current is low, such as in the power saving modes, the +B input potential may pass through the protective diode and increase the potential at the V<sub>CC</sub> pin, and this may affect other devices.
  - Note that if a +B signal is input when the microcontroller power supply is off (not fixed at 0 V) , the microcontroller may partially malfunction on power supplied through the +B signal pin.
  - Note that if the +B input is applied during power-on, the power supply voltage may reach a level such that the power-on reset does not function due to the power supplied from the +B signal.
  - Care must be taken not to leave +B input pins open.
  - Note that analog system input/output pins (LCD drive pins, comparator input pins, etc.) cannot accept +B signal inputs.
  - Sample recommended circuit :



**WARNING:** Semiconductor devices can be permanently damaged by application of stress (voltage, current, temperature, etc.) in excess of absolute maximum ratings. Do not exceed these ratings.

## 2. Recommended Operating Conditions

( $V_{SS} = DV_{SS} = AV_{SS} = 0.0\text{ V}$ )

Parameter	Symbol	Value		Unit	Remarks
		Min	Max		
Power supply voltage	$V_{CC}$	4.0	5.5	V	The low voltage detection reset operates when the power supply voltage reaches $4.2\text{ V} \pm 0.2\text{ V}$ .
	$AV_{CC}$ $DV_{CC}$	4.4	5.5	V	Maintain stop operation status The low voltage detection reset operates when the power supply voltage reaches $4.2\text{ V} \pm 0.2\text{ V}$ .
Smoothing capacitor*	$C_s$	0.1	1.0	$\mu\text{F}$	Use a ceramic capacitor or other capacitor of equivalent frequency characteristics. Use a capacitor with a capacitance greater than this capacitor as the bypass capacitor for the $V_{CC}$ pin.
Operating temperature	$T_A$	- 40	+ 105	$^{\circ}\text{C}$	

\* : Refer to the following diagram for details on the connection of the smoothing capacitor  $C_s$ .



**WARNING:** The recommended operating conditions are required in order to ensure the normal operation of the semiconductor device. All of the device's electrical characteristics are warranted when the device is operated within these ranges.

Always use semiconductor devices within their recommended operating condition ranges. Operation outside these ranges may adversely affect reliability and could result in device failure.

No warranty is made with respect to uses, operating conditions, or combinations not represented on the data sheet. Users considering application outside the listed conditions are advised to contact their representatives beforehand.

# MB90920 Series

## 3. DC Characteristics

( $V_{CC} = 5.0\text{ V} \pm 10\%$ ,  $V_{SS} = DV_{SS} = AV_{SS} = 0.0\text{ V}$ ,  $T_A = -40\text{ }^\circ\text{C}$  to  $+105\text{ }^\circ\text{C}$ )

Parameter	Symbol	Pin name	Conditions	Value			Unit	Remarks
				Min	Typ	Max		
“H” level input voltage	$V_{IHA}$	—	—	$0.8 V_{CC}$	—	—	V	Pin inputs if Automotive input levels are selected
	$V_{IHS}$	—	—	$0.8 V_{CC}$	—	—	V	Pin inputs if CMOS hysteresis input levels are selected
	$V_{IHC}$	—	—	$0.7 V_{CC}$	—	—	V	$\overline{\text{RST}}$ input pin (CMOS hysteresis)
“L” level input voltage	$V_{ILA}$	—	—	—	—	$0.5 V_{CC}$	V	Pin inputs if Automotive input levels are selected
	$V_{ILS}$	—	—	—	—	$0.2 V_{CC}$	V	Pin inputs if CMOS hysteresis input levels are selected
	$V_{ILR}$	—	—	—	—	$0.3 V_{CC}$	V	$\overline{\text{RST}}$ input pin (CMOS hysteresis)
Powersupply current*	$I_{CC}$	$V_{CC}$	Maximum operating frequency $F_{CP} = 32\text{ MHz}$ , normal operation	—	35	45	mA	
			Maximum operating frequency $F_{CP} = 32\text{ MHz}$ , writing Flash memory	—	55	65	mA	
	$I_{CCS}$		Operating frequency $F_{CP} = 32\text{ MHz}$ , sleep mode	—	13	20	mA	
	$I_{CTS}$		Operating frequency $F_{CP} = 2\text{ MHz}$ , time-base timer mode	—	0.6	1.0	mA	
	$I_{CTSPLL}$		Operating frequency $F_{CP} = 32\text{ MHz}$ , PLL timer mode, External frequency = 4 MHz	—	2.5	4	mA	
	$I_{CCL}$		Operating frequency $F_{CP} = 8\text{ kHz}$ , $T_A = +25\text{ }^\circ\text{C}$ , sub clock operation	—	120	270	$\mu\text{A}$	
	$I_{CCLS}$		Operating frequency $F_{CP} = 8\text{ kHz}$ , $T_A = +25\text{ }^\circ\text{C}$ , sub sleep operation	—	100	200	$\mu\text{A}$	
	$I_{CCT}$		Operating frequency $F_{CP} = 8\text{ kHz}$ , $T_A = +25\text{ }^\circ\text{C}$ , watch mode	—	90	180	$\mu\text{A}$	
	$I_{CCH}$		$T_A = +25\text{ }^\circ\text{C}$ , stop mode	—	80	170	$\mu\text{A}$	

(Continued)

# MB90920 Series

( $V_{CC} = 5.0\text{ V} \pm 10\%$ ,  $V_{SS} = DV_{SS} = AV_{SS} = 0.0\text{ V}$ ,  $T_A = -40\text{ }^\circ\text{C}$  to  $+105\text{ }^\circ\text{C}$ )

Parameter	Symbol	Pin name	Conditions	Value			Unit	Remarks
				Min	Typ	Max		
Input leakage current	$I_{IL}$	All input pins	$V_{CC} = DV_{CC} = AV_{CC} = 5.5\text{ V}$ , $V_{SS} < V_I < V_{CC}$	—	—	10	$\mu\text{A}$	
Input capacitance 1	$C_{IN1}$	All pins except VCC, VSS, DVCC, DVSS, AVCC, AVSS, C, P70 to P77, P80 to P87	—	—	—	15	pF	
Input capacitance 2	$C_{IN2}$	P70 to P77, P80 to P87	—	—	—	45	pF	
Pull-up resistance	$R_{UP}$	$\overline{RST}$	—	25	50	100	k $\Omega$	
Pull-down resistance	$R_{DOWN}$	MD2	—	—	—	100	k $\Omega$	Excluding Flash memory product
General-purpose output "H" voltage	$V_{OH1}$	All pins except P70 to P77, P80 to P87	$V_{CC} = 4.5\text{ V}$ , $I_{OH} = -4.0\text{ mA}$	$V_{CC} - 0.5$	—	—	V	
Stepping motor output "H" voltage	$V_{OH2}$	P70 to P77, P80 to P87	$V_{CC} = 4.5\text{ V}$ , $I_{OH} = -30.0\text{ mA}$	$V_{CC} - 0.5$	—	—	V	
General-purpose output "L" voltage	$V_{OL1}$	All pins except P70 to P77, P80 to P87	$V_{CC} = 4.5\text{ V}$ , $I_{OL} = 4.0\text{ mA}$	—	—	0.4	V	
Stepping motor output "L" voltage	$V_{OL2}$	P70 to P77, P80 to P87	$V_{CC} = 4.5\text{ V}$ , $I_{OL} = 30.0\text{ mA}$	—	—	0.55	V	
Stepping motor output phase variation "H"	$\Delta V_{OH}$	PWM1Pn, PWM1Mn, PWM2Pn, PWM2Mn, n = 0 to 3	$V_{CC} = 4.5\text{ V}$ , $I_{OH} = -30.0\text{ mA}$ , maximum deviation $V_{OH2}$	—	—	90	mV	
Stepping motor output phase variation "L"	$\Delta V_{OL}$	PWM1Pn, PWM1Mn, PWM2Pn, PWM2Mn, n = 0 to 3	$V_{CC} = 4.5\text{ V}$ , $I_{OL} = 30.0\text{ mA}$ , maximum deviation $V_{OH2}$	—	—	90	mV	
LCD internal divider resistance	$R_{LCD}$	Between V0 and V1, Between V1 and V2, Between V2 and V3	—	50	100	200	k $\Omega$	Evaluation product
				8.75	12.5	17.0	k $\Omega$	Flash memory product

(Continued)

# MB90920 Series

(Continued)

( $V_{CC} = 5.0\text{ V} \pm 10\%$ ,  $V_{SS} = DV_{SS} = AV_{SS} = 0.0\text{ V}$ ,  $T_A = -40\text{ }^\circ\text{C}$  to  $+105\text{ }^\circ\text{C}$ )

Parameter	Symbol	Pin name	Conditions	Value			Unit	Remarks
				Min	Typ	Max		
LCDC leakage current	$I_{LCDC}$	V0 to V3, COMm (m = 0 to 3) , SEgn, (n = 00 to 31)	—	—	—	5.0	$\mu\text{A}$	
LCD output impedance	$R_{vcom}$	COMn (n = 0 to 3)	—	—	—	4.5	$\text{k}\Omega$	
	$R_{vseg}$	SEgn (n = 00 to 31)	—	—	—	17	$\text{k}\Omega$	

\* : Power supply current values assume an external clock supplied to the X1 pin and X1A pin. Users must be aware that power supply current levels differ depending on whether an external clock or oscillator is used.

## 4. AC Characteristics

### (1) Clock timing

( $V_{CC} = 5.0\text{ V} \pm 10\%$ ,  $V_{SS} = DV_{SS} = AV_{SS} = 0.0\text{ V}$ ,  $T_A = -40\text{ }^\circ\text{C}$  to  $+105\text{ }^\circ\text{C}$ )

Parameter	Symbol	Pin name	Condi- tions	Value			Unit	Remarks
				Min	Typ	Max		
Clock frequency	F <sub>C</sub>	X0, X1	—	3	—	16	MHz	1/2 (PLL stopped) When using the oscillator circuit
				3	—	32	MHz	1/2 (PLL stopped) When using an external clock
				4	—	32	MHz	PLL multiplied by 1
				3	—	16	MHz	PLL multiplied by 2
				3	—	10.7	MHz	PLL multiplied by 3
				3	—	8	MHz	PLL multiplied by 4
				3	—	5.33	MHz	PLL multiplied by 6
	3	—		4	MHz	PLL multiplied by 8		
	F <sub>LC</sub>	X0A, X1A	—	32.768	—	kHz		
Clock cycle time	t <sub>CYL</sub>	X0, X1	—	62.5	—	333	ns	When using an oscillator
			—	31.25	—	333	ns	External clock input
	t <sub>LCYL</sub>	X0A, X1A	—	30.5	—	—	μs	
Input clock pulse width	P <sub>WH</sub> , P <sub>WL</sub>	X0	—	5	—	—	ns	Use duty ratio of 50% ± 3% as a guideline
	P <sub>WLH</sub> , P <sub>WLL</sub>	X0A	—	—	15.2	—	μs	
Input clock rise and fall time	t <sub>cr</sub> , t <sub>cf</sub>	X0	—	—	5	—	ns	When using an external clock signal
Internal operating clock frequency	F <sub>CP</sub>	—	—	1.5	—	32	MHz	Using main clock (PLL clock)
	F <sub>LCP</sub>	—	—	—	8.192	—	kHz	Using sub clock
Internal operating clock cycle time	t <sub>CP</sub>	—	—	31.25	—	666	ns	Using main clock (PLL clock)
	t <sub>LCP</sub>	—	—	—	122.1	—	μs	Using sub clock



- X0, X1 clock timing



- X0A, X1A clock timing



## • Guaranteed PLL Operation Range



- Notes :
- For PLL 1  $\times$  only, use with  $t_{cp} = 4$  MHz or greater.
  - Refer to "5. A/D Converter (1) Electrical Characteristics" for details on the A/D converter operating frequency.

(Continued)

(Continued)



\*1 : When the PLL multiplier is  $\times 1$ ,  $\times 2$ ,  $\times 3$  or  $\times 4$  and the internal clock is  $20 \text{ MHz} < f_{CP} \leq 32 \text{ MHz}$ , set DIV2 bit = "1"\*4, CS2 bit = "1" in the PSCCR register.

[Example] When using a base oscillator frequency of 24 MHz at PLL  $\times 1$  :

CKSCR register : CS1 bit = "0", CS0 bit = "0"

PSCCR register : DIV2 bit = "1"\*4, CS2 bit = "1"

[Example] When using a base oscillator frequency of 6 MHz at PLL  $\times 3$  :

CKSCR register : CS1 bit = "1", CS0 bit = "0"

PSCCR register : DIV2 bit = "1"\*4, CS2 bit = "1"

\*2 : When the PLL multiplier is  $\times 2$  or  $\times 4$  and the internal clock is  $20 \text{ MHz} < f_{CP} \leq 32 \text{ MHz}$ , the following settings are also supported.

PLL  $\times 2$  : CKSCR register : CS1 bit = "0", CS0 bit = "0"

PSCCR register : DIV2 bit = "0"\*4, CS2 bit = "0"

PLL  $\times 4$  : CKSCR register : CS1 bit = "0", CS0 bit = "1"

PSCCR register : DIV2 bit = "0"\*4, CS2 bit = "0"

\*3 : When the PLL multiplier is set to  $\times 6$  or  $\times 8$  set "DIV2 bit = "0"\*4 CS2 bit = "1" and "PLL2 bit = 1" in the PSCCR register.

[Example] When using a base oscillator frequency of 4 MHz at PLL  $\times 6$  :

CKSCR register : CS1 bit = "1", CS0 bit = "0"

PLLOS register : DIV2 bit = "0"\*4, CS2 bit = "1"

[Example] When using a base oscillator frequency of 3 MHz at PLL  $\times 8$  :

CKSCR register : CS1 bit = "1", CS0 bit = "1"

PLLOS register : DIV2 bit = "0"\*4, CS2 bit = "1"

\*4 : The DIV2 bit is assigned to bit 9 of the PSCCR register and the CS2 bit is assigned to bit 8 of the PSCCR register. Both bits have a default value of "0".

## (2) Reset input

( $V_{CC} = 5.0\text{ V} \pm 10\%$ ,  $V_{SS} = AV_{SS} = 0.0\text{ V}$ ,  $T_A = -40\text{ }^\circ\text{C}$  to  $+105\text{ }^\circ\text{C}$ )

Parameter	Symbol	Pin name	Value		Unit	Remarks
			Min	Max		
Reset input time	$t_{RSTL}$	$\overline{RST}$	500	—	ns	During normal operation
			Oscillator oscillation time* + 16 $t_{CP}$	—	ms	In stop mode, sub clock mode, sub sleep mode, and watch mode
			100	—	$\mu\text{s}$	In time-base timer mode

\*: The oscillation time of the oscillator is the time taken to reach 90% of the amplitude. The oscillation time of a crystal oscillator is between several ms and tens of ms. The oscillation time of a ceramic oscillator is between hundreds of  $\mu\text{s}$  and several ms. The oscillation time of an external clock is 0 ms.

Note :  $t_{CP}$  is the internal operating clock cycle time. (Unit : ns)

- During normal operation



- In stop mode, sub clock mode, sub sleep mode, watch mode, and power-on



# MB90920 Series

## (3) Power-on reset

( $V_{CC} = 2.7\text{ V to }3.6\text{ V}$ ,  $V_{SS} = 0.0\text{ V}$ ,  $T_A = -40\text{ }^\circ\text{C to }+105\text{ }^\circ\text{C}$ )

Parameter	Symbol	Pin name	Conditions	Value		Unit	Remarks
				Min	Max		
Power supply rise time	$t_R$	VCC	—	0.05	30	ms	
Power off time	$t_{OFF}$			1	—	ms	Waiting time until power-on

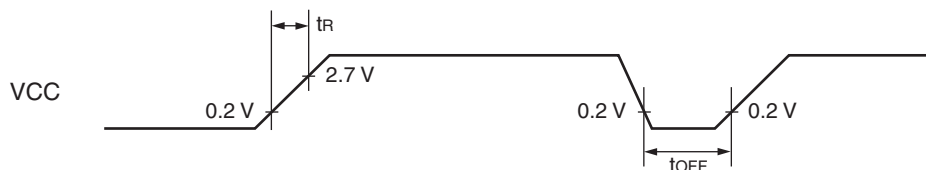

Note : Extreme variations in power supply voltage may trigger a power-on reset. When the power supply voltage is changed during operation, it is recommended that increases in the voltage smoothed out as shown in the following diagram. The PLL clock of the device should not be in use when varying the voltage. However, the PLL clock may continue to be used if the rate of the voltage drop is 1 V/s or less.

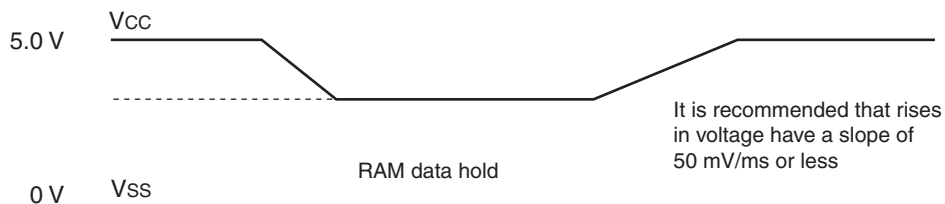

## (4) UART0/1/2/3 (LIN/SCI)

- Bit setting: ESCR0/1/2/3:SCES=0, ECCR0/1/2/3:SCDE=0

( $V_{CC} = 5.0 V \pm 10\%$ ,  $V_{SS} = AV_{SS} = 0.0 V$ ,  $T_A = -40\text{ }^\circ\text{C}$  to  $+105\text{ }^\circ\text{C}$ )

Parameter	Symbol	Pin name	Conditions	Value		Unit
				Min	Max	
Serial clock cycle time	$t_{SCYC}$	SCK0 to SCK3	Internal shift clock mode output pin $C_L = 80\text{ pF} + 1\text{TTL}$	$5 t_{CP}$	—	ns
SCK ↓ → SOT delay time	$t_{SLOVI}$	SCK0 to SCK3, SOT0 to SOT3		- 50	+ 50	ns
Valid SIN → SCK ↑	$t_{IVSHI}$	SCK0 to SCK3, SIN0 to SIN3		$t_{CP} + 80$	—	ns
SCK ↑ → valid SIN hold time	$t_{SHIXI}$			0	—	ns
Serial clock “L” pulse width	$t_{SLSH}$	SCK0 to SCK3	External shift clock mode output pin $C_L = 80\text{ pF} + 1\text{TTL}$	$3 t_{CP} - t_R$	—	ns
Serial clock “H” pulse width	$t_{SHSL}$			$t_{CP} + 10$	—	ns
SCK ↓ → SOT delay time	$t_{SLOVE}$	SCK0 to SCK3, SOT0 to SOT3		—	$2 t_{CP} + 60$	ns
Valid SIN → SCK ↑	$t_{IVSHE}$	SCK0 to SCK3, SIN0 to SIN3		30	—	ns
SCK ↑ → valid SIN hold time	$t_{SHIXE}$			$t_{CP} + 30$	—	ns
SCK ↓ time	$t_F$	SCK0 to SCK3		—	10	ns
SCK ↑ time	$t_R$			—	10	ns

Notes : • Depending on the machine clock frequency to be used, the maximum baud rate may be limited by some parameters. These parameters are shown in “MB90920 series hardware manual”.

- $C_L$  is the load capacitance connected to the pin during testing.
- $t_{CP}$  is the internal operating clock cycle time. Refer to “(1) Clock timing”.

- Internal shift clock mode



- External shift clock mode



# MB90920 Series

- Bit setting: ESCR0/1/2/3:SCES=1, ECCR0/1/2/3:SCDE=0

( $V_{CC} = 5.0 V \pm 10\%$ ,  $V_{SS} = AV_{SS} = 0.0 V$ ,  $T_A = -40\text{ }^\circ\text{C}$  to  $+105\text{ }^\circ\text{C}$ )

Parameter	Symbol	Pin name	Conditions	Value		Unit
				Min	Max	
Serial clock cycle time	$t_{SCYC}$	SCK0 to SCK3	Internal shift clock mode output pin $C_L = 80\text{ pF} + 1\text{TTL}$	$5 t_{CP}$	—	ns
SCK $\uparrow$ $\rightarrow$ SOT delay time	$t_{SHOVI}$	SCK0 to SCK3, SOT0 to SOT3		- 50	+ 50	ns
Valid SIN $\rightarrow$ SCK $\downarrow$	$t_{IVSLI}$	SCK0 to SCK3, SIN0 to SIN3		$t_{CP} + 80$	—	ns
SCK $\downarrow$ $\rightarrow$ valid SIN hold time	$t_{SLIXI}$			0	—	ns
Serial clock "H" pulse width	$t_{SHSL}$	SCK0 to SCK3	External shift clock mode output pin $C_L = 80\text{ pF} + 1\text{TTL}$	$3 t_{CP} - t_R$	—	ns
Serial clock "L" pulse width	$t_{LSLH}$			$t_{CP} + 10$	—	ns
SCK $\uparrow$ $\rightarrow$ SOT delay time	$t_{SHOVE}$	SCK0 to SCK3, SOT0 to SOT3		—	$2 t_{CP} + 60$	ns
Valid SIN $\rightarrow$ SCK $\downarrow$	$t_{IVSLE}$	SCK0 to SCK3, SIN0 to SIN3		30	—	ns
SCK $\downarrow$ $\rightarrow$ valid SIN hold time	$t_{SLIXE}$			$t_{CP} + 30$	—	ns
SCK $\downarrow$ time	$t_F$	SCK0 to SCK3		—	10	ns
SCK $\uparrow$ time	$t_R$			—	10	ns

Notes : • Depending on the machine clock frequency to be used, the maximum baud rate may be limited by some parameters. These parameters are shown in "MB90920 series hardware manual".

- $C_L$  is the load capacitance connected to the pin during testing.
- $t_{CP}$  is the internal operating clock cycle time. Refer to "(1) Clock timing".



- Internal shift clock mode



- External shift clock mode



• Bit setting: ESCR0/1/2/3:SCES=0, ECCR0/1/2/3:SCDE=1

( $V_{CC} = 5.0\text{ V} \pm 10\%$ ,  $V_{SS} = AV_{SS} = 0.0\text{ V}$ ,  $T_A = -40\text{ }^\circ\text{C}$  to  $+105\text{ }^\circ\text{C}$ )

Parameter	Symbol	Pin name	Conditions	Value		Unit
				Min	Max	
Serial clock cycle time	$t_{SCYC}$	SCK0 to SCK3	Internal shift clock mode output pin $C_L = 80\text{ pF} + 1\text{TTL}$	$5 t_{CP}$	—	ns
SCK $\uparrow$ $\rightarrow$ SOT delay time	$t_{SHOVI}$	SCK0 to SCK3, SOT0 to SOT3		- 50	+ 50	ns
Valid SIN $\rightarrow$ SCK $\downarrow$	$t_{IVSLI}$	SCK0 to SCK3, SIN0 to SIN3		$t_{CP} + 80$	—	ns
SCK $\downarrow$ $\rightarrow$ valid SIN hold time	$t_{SLIXI}$			0	—	ns
SOT $\rightarrow$ SCK $\downarrow$ delay time	$t_{SOVLI}$	SCK0 to SCK3, SOT0 to SOT3		$3 t_{CP} - 70$	—	ns

Notes : • Depending on the machine clock frequency to be used, the maximum baud rate may be limited by some parameters. These parameters are shown in “MB90920 series hardware manual”.

•  $C_L$  is the load capacitance connected to the pin during testing.

•  $t_{CP}$  is the internal operating clock cycle time. Refer to “(1) Clock timing”.



# MB90920 Series

- Bit setting:  $ESCR0/1/2/3:SCES=1$ ,  $ECCR0/1/2/3:SCDE=1$

( $V_{CC} = 5.0 V \pm 10\%$ ,  $V_{SS} = AV_{SS} = 0.0 V$ ,  $T_A = -40\text{ }^\circ\text{C}$  to  $+105\text{ }^\circ\text{C}$ )

Parameter	Symbol	Pin name	Conditions	Value		Unit
				Min	Max	
Serial clock cycle time	$t_{SCYC}$	SCK0 to SCK3	Internal shift clock mode output pin $C_L = 80\text{ pF} + 1\text{ TTL}$	$5 t_{CP}$	—	ns
SCK ↓ → SOT delay time	$t_{SLOVI}$	SCK0 to SCK3, SOT0 to SOT3		- 50	+ 50	ns
Valid SIN → SCK ↓	$t_{IVSHI}$	SCK0 to SCK3, SIN0 to SIN3		$t_{CP} + 80$	—	ns
SCK ↑ → valid SIN hold time	$t_{SHIXI}$	SCK0 to SCK3, SIN0 to SIN3		0	—	ns
SOT → SCK ↑ delay time	$t_{SOVHI}$	SCK0 to SCK3, SOT0 to SOT3		$3 t_{CP} - 70$	—	ns

- Notes :
- Depending on the machine clock frequency to be used, the maximum baud rate may be limited by some parameters. These parameters are shown in “MB90920 series hardware manual”.
  - $C_L$  is the load capacitance connected to the pin during testing.
  - $t_{CP}$  is the internal operating clock cycle time. Refer to “(1) Clock timing”.

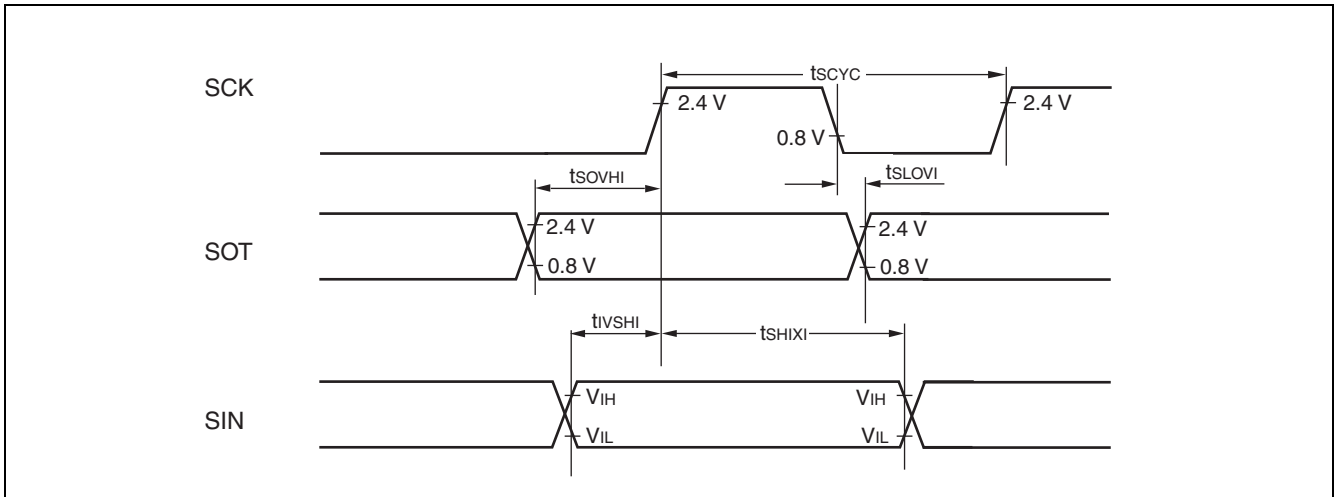

## (5) Timer input timing

( $V_{CC} = 5.0\text{ V} \pm 10\%$ ,  $V_{SS} = AV_{SS} = 0.0\text{ V}$ ,  $T_A = -40\text{ }^\circ\text{C}$  to  $+105\text{ }^\circ\text{C}$ )

Parameter	Symbol	Pin name	Conditions	Value		Unit
				Min	Max	
Input pulse width	$t_{TIWH}$ $t_{TIWL}$	TIN0, TIN1, IN0 to IN3	—	4 $t_{CP}$	—	ns

Note :  $t_{CP}$  is the internal operating clock cycle time. Refer to “(1) Clock timing”.

- Timer input timing



## (6) Trigger input timing

( $V_{CC} = 5.0\text{ V} \pm 10\%$ ,  $V_{SS} = AV_{SS} = 0.0\text{ V}$ ,  $T_A = -40\text{ }^\circ\text{C}$  to  $+105\text{ }^\circ\text{C}$ )

Parameter	Symbol	Pin name	Conditions	Value		Unit	Remarks
				Min	Max		
Input pulse width	$t_{TRGH}$ , $t_{TRGL}$	INT0 to INT7	—	200	—	ns	During normal operation
		ADTG	—	$t_{CP} + 200$	—	ns	

Note :  $t_{CP}$  is the internal operating clock cycle time. Refer to “(1) Clock timing”.

- Trigger input timing

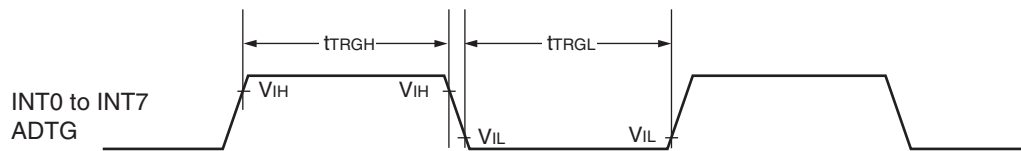

## (7) Low voltage detection

( $V_{SS} = AV_{SS} = 0.0\text{ V}$ ,  $T_A = -40\text{ °C}$  to  $+105\text{ °C}$ )

Parameter	Symbol	Pin name	Conditions	Value			Unit	Remarks
				Min	Typ	Max		
Detection voltage	$V_{DL}$	VCC	—	4.0	4.2	4.4	V	Flash memory product, during voltage drop
				3.7	4.0	4.3	V	Evaluation product, during voltage drop
Hysteresis width	$V_{HYS}$	VCC	—	190	—	—	mV	Flash memory product, during voltage rise
				0.1	—	—	V	Evaluation product, during voltage rise
Power supply voltage change rate	dV/dt	VCC	—	-0.1	—	+0.1	V/ $\mu$ s	Flash memory product, dV/dt at low voltage reset
				-0.004	—	+0.004	V/ $\mu$ s	Flash memory product, dV/dt at standard value of low voltage detection/release voltage
				-0.1	—	+0.02	V/ $\mu$ s	Evaluation product
Detection delay time	$t_d$	—	—	—	—	3.2	$\mu$ s	Flash memory product, when dV/dt $\leq$ 0.004 V/ $\mu$ s
				—	—	35	$\mu$ s	Evaluation product

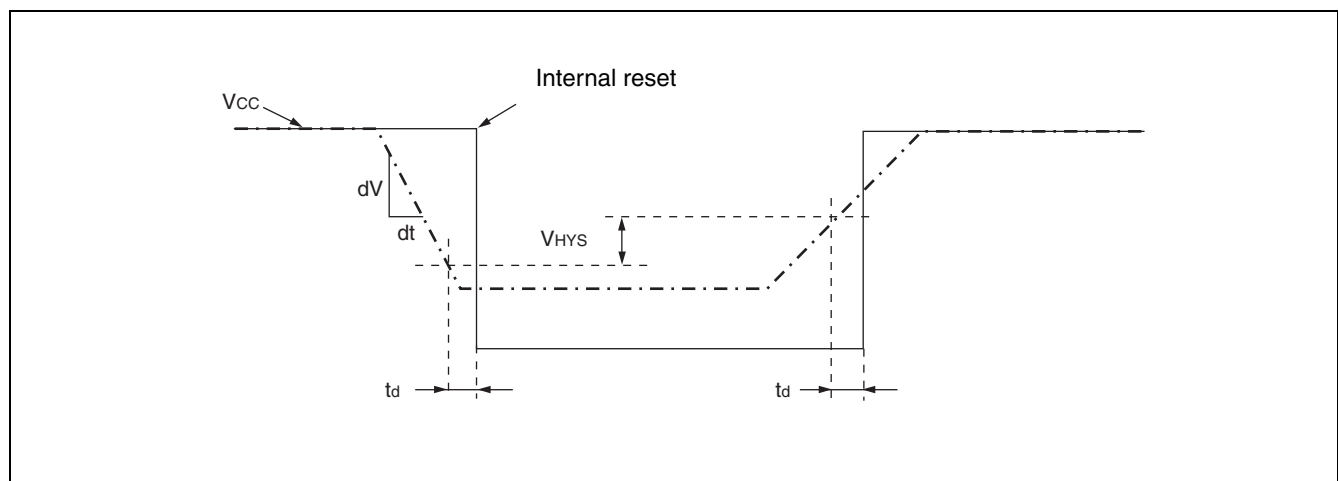

# MB90920 Series

## 5. A/D Converter

### (1) Electrical Characteristics

( $V_{CC} = AV_{CC} = AVRH = 4.0\text{ V to }5.5\text{ V}$ ,  $V_{SS} = AV_{SS} = 0.0\text{ V}$ ,  $T_A = -40\text{ }^{\circ}\text{C to }+105\text{ }^{\circ}\text{C}$ )

Parameter	Symbol	Pin name	Value			Unit	Remarks
			Min	Typ	Max		
Resolution	—	—	—	—	10	bit	
Total error	—	—	- 3.0	—	+ 3.0	LSB	
Non-linear error	—	—	- 2.5	—	+ 2.5	LSB	
Differential linear error	—	—	- 1.9	—	+ 1.9	LSB	
Zero transition voltage	$V_{OT}$	AN0 to AN7	$AV_{SS} - 1.5\text{ LSB}$	$AV_{SS} + 0.5\text{ LSB}$	$AV_{SS} + 2.5\text{ LSB}$	V	1 LSB = ( $AVRH - AV_{SS}$ ) / 1024
Full scale transition voltage	$V_{FST}$	AN0 to AN7	$AVRH - 3.5\text{ LSB}$	$AVRH - 1.5\text{ LSB}$	$AVRH + 0.5\text{ LSB}$	V	
Sampling time	$t_{SMP}$	—	0.4	—	16500	$\mu\text{s}$	4.5 V $\leq$ $AV_{CC} \leq$ 5.5 V
			1.0				4.0 V $\leq$ $AV_{CC} \leq$ 4.5 V
Compare time	$t_{CMP}$	—	0.66	—	—	$\mu\text{s}$	4.5 V $\leq$ $AV_{CC} \leq$ 5.5 V
			2.2				4.0 V $\leq$ $AV_{CC} \leq$ 4.5 V
A/D conversion time	$t_{CNV}$	—	1.44	—	—	$\mu\text{s}$	*1
Analog port input current	$I_{AIN}$	AN0 to AN7	- 0.3	—	+ 10	$\mu\text{A}$	
Analog input voltage	$V_{AIN}$	AN0 to AN7	0	—	$AVRH$	V	
Reference voltage	$AV+$	$AVRH$	$AV_{SS} + 2.7$	—	$AV_{CC}$	V	
Power supply current	$I_A$	$AV_{CC}$	—	2.3	6.0	mA	
	$I_{AH}$		—	—	5	$\mu\text{A}$	*2
Reference voltage supply current	$I_R$	$AVRH$	—	520	900	$\mu\text{A}$	$V_{AVRH} = 5.0\text{ V}$
	$I_{RH}$		—	—	5	$\mu\text{A}$	*2
Inter-channel variation	—	AN0 to AN7	—	—	4	LSB	

\*1 : The time per channel (4.5 V  $\leq$   $AV_{CC} \leq$  5.5 V, and internal operating frequency = 32 MHz) .

\*2 : Defined as supply current (when  $V_{CC} = AV_{CC} = AVRH = 5.0\text{ V}$ ) with A/D converter not operating, and CPU in stop mode.

- Notes on the external impedance and sampling time of analog inputs

A/D converter with sample and hold circuit. If the external impedance is too high to keep sufficient sampling time, the analog voltage charged to the internal sample and hold capacitor is insufficient, adversely affecting A/D conversion precision. Therefore, to satisfy the A/D conversion precision standard, consider the relationship between the external impedance and minimum sampling time and either adjust the register value and operating frequency or decrease the external impedance so that the sampling time is longer than the minimum value. If the sampling time is still not sufficient, connect a capacitor of about 0.1  $\mu\text{F}$  to the analog input pin.

- Analog input equivalent circuit

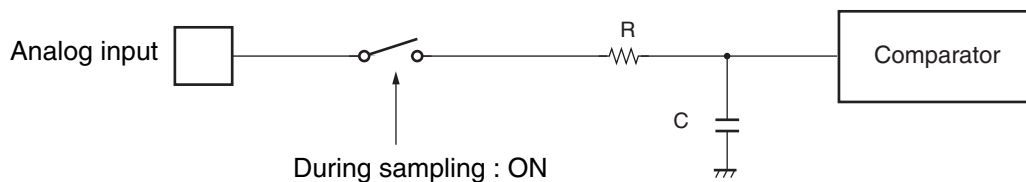

MB90F922NC/F922NCS/ F923NC/F923NCS/F924NC/F924NCS  
MB90922NCS

	R	C
$4.5 \text{ V} \leq AV_{\text{cc}} \leq 5.5 \text{ V}$	: 2.6 k $\Omega$ (Max)	8.5 pF (Max)
$4.0 \text{ V} \leq AV_{\text{cc}} \leq 4.5 \text{ V}$	: 12.1 k $\Omega$ (Max)	8.5 pF (Max)

MB90V920-101/102

$4.5 \text{ V} \leq AV_{\text{cc}} \leq 5.5 \text{ V}$	: 2.0 k $\Omega$ (Max)	14.4 pF (Max)
$4.0 \text{ V} \leq AV_{\text{cc}} \leq 4.5 \text{ V}$	: 8.2 k $\Omega$ (Max)	14.4 pF (Max)

Note : The values are reference values.



# MB90920 Series

- The relationship between the external impedance and minimum sampling time
- At  $4.5\text{ V} \leq AV_{CC} \leq 5.5\text{ V}$

(External impedance = 0 kΩ to 100 kΩ)

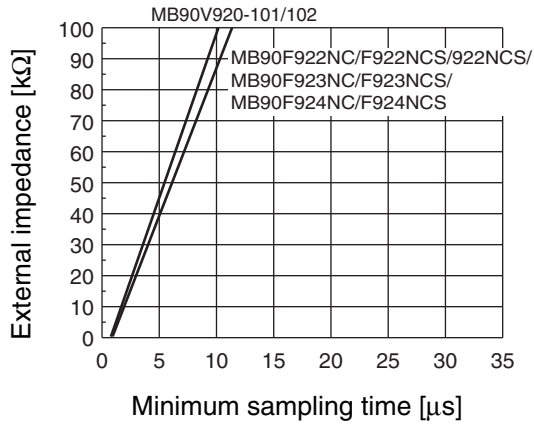

(External impedance = 0 kΩ to 20 kΩ)



- At  $4.0\text{ V} \leq AV_{CC} \leq 4.5\text{ V}$

(External impedance = 0 kΩ to 100 kΩ)



(External impedance = 0 kΩ to 20 kΩ)



- About errors  
As  $|AV_{RH} - AV_{SS}|$  becomes smaller, the relative errors grow larger.

## (2) Definition of terms

- Resolution : Analog changes that are identifiable by the A/D converter.
- Non-Linear error : The deviation of the straight line connecting the zero transition point (“00 0000 0000” ↔ “00 0000 0001”) with the full-scale transition point (“11 1111 1110” ↔ “11 1111 1111”) from actual conversion characteristics.
- Differential linear error : The deviation from the ideal value of the input voltage needed to change the output code by 1 LSB.
- Total error : The total error is the difference between the actual value and the theoretical value, and includes zero-transition error/full-scale transition error and linear error.



$$\text{Total error for digital output } N = \frac{V_{NT} - \{1 \text{ LSB} \times (N - 1) + 0.5 \text{ LSB}\}}{1 \text{ LSB}} \quad [\text{LSB}]$$

$$1 \text{ LSB (Ideal)} = \frac{AV_{RH} - AV_{SS}}{1024} \quad [\text{V}]$$

N : A/D converter digital output value

$$V_{OT} \text{ (Ideal)} = AV_{SS} + 0.5 \text{ LSB} \quad [\text{V}]$$

$$V_{FST} \text{ (Ideal)} = AV_{RH} - 1.5 \text{ LSB} \quad [\text{V}]$$

V<sub>NT</sub> : Voltage when the digital output changes from (N - 1) to N

(Continued)

(Continued)



$$\text{Non-linear error of digital output N} = \frac{V_{NT} - \{1 \text{ LSB} \times (N - 1) + V_{OT}\}}{1 \text{ LSB}} \text{ [LSB]}$$

$$\text{Differential linear error of digital output N} = \frac{V_{(N+1)T} - V_{NT}}{1 \text{ LSB}} - 1 \text{ [LSB]}$$

$$1 \text{ LSB} = \frac{V_{FST} - V_{OT}}{1022} \text{ [V]}$$

N : A/D converter digital output value

$V_{OT}$  : Voltage when digital output changes from 000H to 001H

$V_{FST}$  : Voltage when digital output changes from 3FEH to 3FFH

## 6. Flash Memory Program/Erase Characteristics

Parameter	Conditions	Value			Unit	Remarks
		Min	Typ	Max		
Sector erase time	$T_A = +25\text{ }^\circ\text{C}$ $V_{CC} = 5.0\text{ V}$	—	0.9	3.6	s	Excludes pre-programming before erase
Word (16-bit width) programming time		—	23	370	$\mu\text{s}$	Excludes system-level overhead
Chip programming time	$T_A = +25\text{ }^\circ\text{C}$ , $V_{CC} = 5.0\text{ V}$	—	3.4	55	s	
Erase/program cycle	—	10000	—	—	cycle	
Flash memory data retention time	Average $T_A = +85\text{ }^\circ\text{C}$	20	—	—	year	*

\* : This value is calculated from the results of evaluating the reliability of the technology (using Arrhenius equation to translate high temperature measurements into normalized value at + 85 °C) .

# MB90920 Series

## ■ ORDERING INFORMATION

Part number	Package	Remarks
MB90F922NCPMC MB90F922NCSPMC MB90922NCSPMC MB90F923NCPMC MB90F923NCSPMC MB90F924NCPMC MB90F924NCSPMC	120-pin plastic LQFP (FPT-120P-M21)	
MB90V920-101CR MB90V920-102CR	299-pin ceramic PGA (PGA-299C-A01)	For evaluation

## PACKAGE DIMENSION

 <p>120-pin plastic LQFP</p> <p>(FPT-120P-M21)</p>	Lead pitch	0.50 mm
	Package width × package length	16.0 × 16.0 mm
	Lead shape	Gullwing
	Sealing method	Plastic mold
	Mounting height	1.70 mm MAX
	Weight	0.88 g
	Code (Reference)	P-LFQFP120-16×16-0.50



Please check the latest package dimension at the following URL.  
<http://edevic.fujitsu.com/package/en-search/>

# MB90920 Series

## ■ MAJOR CHANGES IN THIS EDITION

Page	Section	Change Results
12	■ I/O CIRCUIT TYPE	Corrected the circuit type B.
20	■ HANDLING DEVICES	Added the following items; <ul style="list-style-type: none"><li>• Serial communication</li><li>• Characteristic difference between flash device and MASK ROM device</li></ul>
31	■ I/O MAP	Corrected "Address: 003970H". Clock supervisor control register → (Disabled)
46	■ ELECTRICAL CHARACTERISTICS 3. DC Characteristics	Added the item for "LCD output impedance".
68	■ ORDERING INFORMATION	Corrected the part numbers; MB90V920-101 → MB90V920-101CR MB90V920-102 → MB90V920-102CR

The vertical lines marked in the left side of the page show the changes.

**MEMO**



# MB90920 Series

## FUJITSU SEMICONDUCTOR LIMITED

Nomura Fudosan Shin-yokohama Bldg. 10-23, Shin-yokohama 2-Chome,  
Kohoku-ku Yokohama Kanagawa 222-0033, Japan

Tel: +81-45-415-5858

<http://jp.fujitsu.com/fsl/en/>

*For further information please contact:*

### North and South America

FUJITSU SEMICONDUCTOR AMERICA, INC.

1250 E. Arques Avenue, M/S 333

Sunnyvale, CA 94085-5401, U.S.A.

Tel: +1-408-737-5600 Fax: +1-408-737-5999

<http://us.fujitsu.com/micro/>

### Asia Pacific

FUJITSU SEMICONDUCTOR ASIA PTE. LTD.

151 Lorong Chuan,

#05-08 New Tech Park 556741 Singapore

Tel : +65-6281-0770 Fax : +65-6281-0220

<http://www.fujitsu.com/sg/services/micro/semiconductor/>

### Europe

FUJITSU SEMICONDUCTOR EUROPE GmbH

Pittlerstrasse 47, 63225 Langen, Germany

Tel: +49-6103-690-0 Fax: +49-6103-690-122

<http://emea.fujitsu.com/semiconductor/>

FUJITSU SEMICONDUCTOR SHANGHAI CO., LTD.

Rm. 3102, Bund Center, No.222 Yan An Road (E),

Shanghai 200002, China

Tel : +86-21-6146-3688 Fax : +86-21-6335-1605

<http://cn.fujitsu.com/fss/>

### Korea

FUJITSU SEMICONDUCTOR KOREA LTD.

206 Kosmo Tower Building, 1002 Daechi-Dong,

Gangnam-Gu, Seoul 135-280, Republic of Korea

Tel: +82-2-3484-7100 Fax: +82-2-3484-7111

<http://kr.fujitsu.com/fmk/>

FUJITSU SEMICONDUCTOR PACIFIC ASIA LTD.

10/F., World Commerce Centre, 11 Canton Road,

Tsimshatsui, Kowloon, Hong Kong

Tel : +852-2377-0226 Fax : +852-2376-3269

<http://cn.fujitsu.com/fsp/>

Specifications are subject to change without notice. For further information please contact each office.

### All Rights Reserved.

The contents of this document are subject to change without notice.

Customers are advised to consult with sales representatives before ordering.

The information, such as descriptions of function and application circuit examples, in this document are presented solely for the purpose of reference to show examples of operations and uses of FUJITSU SEMICONDUCTOR device; FUJITSU SEMICONDUCTOR does not warrant proper operation of the device with respect to use based on such information. When you develop equipment incorporating the device based on such information, you must assume any responsibility arising out of such use of the information.

FUJITSU SEMICONDUCTOR assumes no liability for any damages whatsoever arising out of the use of the information.

Any information in this document, including descriptions of function and schematic diagrams, shall not be construed as license of the use or exercise of any intellectual property right, such as patent right or copyright, or any other right of FUJITSU SEMICONDUCTOR or any third party or does FUJITSU SEMICONDUCTOR warrant non-infringement of any third-party's intellectual property right or other right by using such information. FUJITSU SEMICONDUCTOR assumes no liability for any infringement of the intellectual property rights or other rights of third parties which would result from the use of information contained herein.

The products described in this document are designed, developed and manufactured as contemplated for general use, including without limitation, ordinary industrial use, general office use, personal use, and household use, but are not designed, developed and manufactured as contemplated (1) for use accompanying fatal risks or dangers that, unless extremely high safety is secured, could have a serious effect to the public, and could lead directly to death, personal injury, severe physical damage or other loss (i.e., nuclear reaction control in nuclear facility, aircraft flight control, air traffic control, mass transport control, medical life support system, missile launch control in weapon system), or (2) for use requiring extremely high reliability (i.e., submersible repeater and artificial satellite).

Please note that FUJITSU SEMICONDUCTOR will not be liable against you and/or any third party for any claims or damages arising in connection with above-mentioned uses of the products.

Any semiconductor devices have an inherent chance of failure. You must protect against injury, damage or loss from such failures by incorporating safety design measures into your facility and equipment such as redundancy, fire protection, and prevention of over-current levels and other abnormal operating conditions.

Exportation/release of any products described in this document may require necessary procedures in accordance with the regulations of the Foreign Exchange and Foreign Trade Control Law of Japan and/or US export control laws.

The company names and brand names herein are the trademarks or registered trademarks of their respective owners.

# Mouser Electronics

Authorized Distributor

Click to View Pricing, Inventory, Delivery & Lifecycle Information:

## Cypress Semiconductor:

[MB90922NCSPMC-GS-266E1](#) [MB90922NCSPMC-GS-264E1](#) [MB90922NCSPMC-GS-234E1](#) [MB90922NCSPMC-GS-128E1](#) [MB90922NCSPMC-GS-231E1](#) [MB90922NCSPMC-GS-204E1](#) [MB90922NCSPMC-GS-147E1](#)  
[MB90922NCSPMC-GS-192E1](#) [MB90922NCSPMC-GS-224E1](#) [MB90922NCSPMC-GS-249E1](#) [MB90922NCSPMC-GS-213E1](#) [MB90922NCSPMC-GS-137E1](#) [MB90922NCSPMC-GS-258E1](#) [MB90922NCSPMC-GS-159E1](#)  
[MB90922NCSPMC-GS-114E1](#) [MB90922NCSPMC-GS-256E1](#) [MB90922NCSPMC-GS-171E1](#) [MB90922NCSPMC-GS-136E1](#) [MB90922NCSPMC-GS-161E1](#) [MB90922NCSPMC-GS-222E1](#) [MB90922NCSPMC-GS-259E1](#)  
[MB90922NCSPMC-GS-187E1](#) [MB90922NCSPMC-GS-206E1](#) [MB90922NCSPMC-GS-132E1](#) [MB90922NCSPMC-GS-167E1](#) [MB90922NCSPMC-GS-207E1](#) [MB90922NCSPMC-GS-143E1](#) [MB90922NCSPMC-GS-154E1](#)  
[MB90922NCSPMC-GS-208E1](#) [MB90922NCSPMC-GS-235E1](#) [MB90922NCSPMC-GS-135E1](#) [MB90922NCSPMC-GS-225E1](#) [MB90922NCSPMC-GS-257E1](#) [MB90922NCSPMC-GS-164E1](#) [MB90922NCSPMC-GS-214E1](#)  
[MB90922NCSPMC-GS-178E1](#) [MB90922NCSPMC-GS-190E1](#) [MB90922NCSPMC-GS-160E1](#) [MB90922NCSPMC-GS-138E1](#) [MB90922NCSPMC-GS-262E1](#) [MB90922NCSPMC-GS-173E1](#) [MB90922NCSPMC-GS-201E1](#)  
[MB90922NCSPMC-GS-184E1](#) [MB90922NCSPMC-GS-223E1](#) [MB90922NCSPMC-GS-248E1](#) [MB90922NCSPMC-GS-148E1](#) [MB90922NCSPMC-GS-134E1](#) [MB90922NCSPMC-GS-177E1](#) [MB90922NCSPMC-GS-183E1](#)  
[MB90922NCSPMC-GS-181E1](#) [MB90922NCSPMC-GS-261E1](#) [MB90922NCSPMC-GS-211E1](#) [MB90922NCSPMC-GS-122E1](#) [MB90922NCSPMC-GS-180E1](#) [MB90922NCSPMC-GS-151E1](#) [MB90922NCSPMC-GS-115E1](#)  
[MB90922NCSPMC-GS-238E1](#) [MB90922NCSPMC-GS-189E1](#) [MB90922NCSPMC-GS-233E1](#) [MB90922NCSPMC-GS-152E1](#) [MB90922NCSPMC-GS-199E1](#) [MB90922NCSPMC-GS-150E1](#) [MB90922NCSPMC-GS-125E1](#)  
[MB90922NCSPMC-GS-252E1](#) [MB90922NCSPMC-GS-188E1](#) [MB90922NCSPMC-GS-144E1](#) [MB90922NCSPMC-GS-127E1](#) [MB90922NCSPMC-GS-162E1](#) [MB90922NCSPMC-GS-193E1](#) [MB90922NCSPMC-GS-246E1](#)  
[MB90922NCSPMC-GS-230E1](#) [MB90922NCSPMC-GS-202E1](#) [MB90922NCSPMC-GS-244E1](#) [MB90922NCSPMC-GS-140E1](#) [MB90922NCSPMC-GS-176E1](#) [MB90922NCSPMC-GS-172E1](#) [MB90922NCSPMC-GS-209E1](#)  
[MB90922NCSPMC-GS-221E1](#) [MB90922NCSPMC-GS-205E1](#) [MB90922NCSPMC-GS-163E1](#) [MB90922NCSPMC-GS-191E1](#) [MB90922NCSPMC-GS-218E1](#) [MB90922NCSPMC-GS-271E1](#) [MB90922NCSPMC-GS-166E1](#)  
[MB90922NCSPMC-GS-240E1](#) [MB90922NCSPMC-GS-220E1](#) [MB90922NCSPMC-GS-139E1](#) [MB90922NCSPMC-GS-170E1](#) [MB90922NCSPMC-GS-157E1](#) [MB90922NCSPMC-GS-117E1](#) [MB90922NCSPMC-GS-129E1](#)  
[MB90922NCSPMC-G-003E1](#) [MB90922NCSPMC-GS-212E1](#) [MB90922NCSPMC-GS-165E1](#) [MB90922NCSPMC-GS-126E1](#) [MB90922NCSPMC-GS-186E1](#) [MB90922NCSPMC-GS-153E1](#) [MB90922NCSPMC-GS-131E1](#)  
[MB90922NCSPMC-GS-197E1](#) [MB90922NCSPMC-GS-263E1](#)



Компания «ЭлектроПласт» предлагает заключение долгосрочных отношений при поставках импортных электронных компонентов на взаимовыгодных условиях!

Наши преимущества:

- Оперативные поставки широкого спектра электронных компонентов отечественного и импортного производства напрямую от производителей и с крупнейших мировых складов;
- Поставка более 17-ти миллионов наименований электронных компонентов;
- Поставка сложных, дефицитных, либо снятых с производства позиций;
- Оперативные сроки поставки под заказ (от 5 рабочих дней);
- Экспресс доставка в любую точку России;
- Техническая поддержка проекта, помощь в подборе аналогов, поставка прототипов;
- Система менеджмента качества сертифицирована по Международному стандарту ISO 9001;
- Лицензия ФСБ на осуществление работ с использованием сведений, составляющих государственную тайну;
- Поставка специализированных компонентов (Xilinx, Altera, Analog Devices, Intersil, Interpoint, Microsemi, Aeroflex, Peregrine, Syfer, Eurofarad, Texas Instrument, Miteq, Cobham, E2V, MA-COM, Hittite, Mini-Circuits, General Dynamics и др.);

Помимо этого, одним из направлений компании «ЭлектроПласт» является направление «Источники питания». Мы предлагаем Вам помощь Конструкторского отдела:

- Подбор оптимального решения, техническое обоснование при выборе компонента;
- Подбор аналогов;
- Консультации по применению компонента;
- Поставка образцов и прототипов;
- Техническая поддержка проекта;
- Защита от снятия компонента с производства.



#### Как с нами связаться

**Телефон:** 8 (812) 309 58 32 (многоканальный)

**Факс:** 8 (812) 320-02-42

**Электронная почта:** [org@eplast1.ru](mailto:org@eplast1.ru)

**Адрес:** 198099, г. Санкт-Петербург, ул. Калинина, дом 2, корпус 4, литера А.